



ສາທາລະນະລັດ ປະຊາທິປະໄຕ ປະຊາຊົນລາວ
LAO PEOPLE'S DEMOCRATIC REPUBLIC

ກະຊວງ ອຸດສາຫະກຳ ແລະ ການຄ້າ
ກົມຊັບສິນທາງປັນຍາ

MINISTRY OF INDUSTRY AND COMMERCE
DEPARTMENT OF INTELLECTUAL PROPERTY

ຈົດໝາຍເຫດທາງລັດຖະການ
ກ່ຽວກັບ ຊັບສິນທາງປັນຍາ
ຢູ່ ສປປ ລາວ

OFFICIAL GAZETTE ON INTELLECTUAL PROPERTY
IN LAO PDR

ສະບັບທີ (Vol.) 147

ພາກທີ I

(Part I)

ສິດທິບັດ ແລະ ອະນຸສິດທິບັດ (Patent and Petty Patent)

1. ຄໍາຮ້ອງ (Applications)

ຄໍາອະທິບາຍກ່ຽວກັບລະຫັດຫຍໍ້ (Introduction of Codes)

- (21) ເລກທີ ຄໍາຮ້ອງ (Filing Number)
- (22) ວັນທີ ຍືນຄໍາຮ້ອງ (Filing Date)
- (30) ວັນທີ ບຸລິມະສິດ (Priority Date)
- (43) ວັນທີເຜີຍແຜ່ (Publication Date)
- (51) ໝວດ (International Patent Classification)
- (54) ຊື່ຂອງການປະດິດ (Title)
- (57) ບົດຄັດຫຍໍ້ (Abstract)
- (71) ຊື່ ແລະ ທີ່ຢູ່ ເຈົ້າຂອງສິດທິບັດ ແລະ ອະນຸສິດທິບັດ (Owner Name and Address)
- (72) ຊື່ຜູ້ປະດິດ (Inventor Name)
- (74) ຊື່ຕົວແທນ (Representative Name)
- (55) ຮູບຟາບ (Pictures)

ພາກທີ I (Part I)

ສິດທິບັດ ແລະ ອະນຸສິດທິບັດ (Patent and Petty Patent)

2. ຜົນການອອກສິດທິບັດ ແລະ ອະນຸສິດທິບັດ (Grant of Patents and Petty Patents)

ຄຳອະທິບາຍກ່ຽວກັບລະຫັດຫຍໍ້ (Introduction of Codes)

- (11) ເລກທິ (Grant Number)
- (21) ເລກທິ ຄຳຮ້ອງ (Filing Number)
- (22) ວັນທິຍືນຄຳຮ້ອງ (Filing Date)
- (30) ວັນທິ ບຸລິມະສິດ (Priority Date)
- (43) ວັນທິເຜີຍແຜ່ (Publication Date)
- (51) ໝວດ (International Patent Classification)
- (54) ຫົວຂໍ້ການປະດິດ (Title)
- (57) ບົດຄັດຫຍໍ້ (Abstract)
- (71) ຊື່ ແລະ ທີ່ຢູ່ ເຈົ້າຂອງສິດທິບັດ ແລະ ອະນຸສິດທິບັດ (Owner Name and Address)
- (72) ຊື່ຜູ້ປະດິດ (Inventor Name)
- (74) ຊື່ຕົວແທນ (Representative Name)
- (55) ຮູບພາບ (Pictures)

ພາກທີ I

(Part I)

**ສິດທິບັດ ແລະ ອະນຸສິດທິບັດ
(Patent and Petty Patent)**

3. ການປ່ຽນແປງ

(Changes)

ພາກທີ I

(Part I)

**ສິດທິບັດ ແລະ ອະນຸສິດທິບັດ
(Patent and Petty Patent)**

4. ການດັດແກ້

(Amendments)

ພາກທີ II
(Part II)
ແບບອຸດສາຫະກຳ
(Industrial Design)

1. ຄຳຮ້ອງ
(Applications)

ຄຳອະທິບາຍກ່ຽວກັບລະຫັດຫຍໍ້
(Introduction of Codes)

- (21) ເລກທີ ຄຳຮ້ອງ (Filing Number)
- (22) ວັນທີ ຄຳຮ້ອງ (Filing Date)
- (30) ວັນທີ ບຸລິມາສິດ (Priority Date)
- (51) ໝວດ (Locarno Classification)
- (54) ຊື່ຂອງແບບອຸດສາຫະກຳ (Title)
- (71) ຊື່ ແລະ ທີ່ຢູ່ ຂອງເຈົ້າຂອງ (Owner Name and Address)
- (72) ຊື່ຜູ້ອອກແບບ (Designer Name)
- (74) ຊື່ຕົວແທນ (Representative Name)
- (55) ຮູບພາບ (Pictures)

- | | | | |
|------|--|------|------------|
| (11) | No. 403 | (21) | ID 403 |
| (15) | 17/03/2022 | (22) | 26/09/2017 |
| (28) | | (17) | 26/09/2022 |
| (30) | | (51) | |
| (54) | TRUCK | | |
| (71) | yunnan Lifan Junma Vehicles Co., Ltd
Innovation Industrial Park, Fengyi Town, Dali Dity, Yunnan Province 671005, China. | | |
| (72) | MA, Libin; LONG Yunlang; YANG Qian and YANG Chunliang | | |
| (74) | ACTIP (LAO) IP CO., LTD | | |
| (55) | | | |

Fig. 1



Fig. 2



Fig. 3



Fig. 4



Fig. 5



Fig. 6



Fig. 7



- | | | | |
|------|--|------|------------|
| (11) | No. 522 | (21) | ID 522 |
| (15) | 17/03/2022 | (22) | 20/09/2019 |
| (28) | | (17) | 20/09/2024 |
| (30) | | (51) | 12-11 |
| (54) | "Electric bike" | | |
| (71) | MBI Co., Ltd.
(Sachang-dong, Hyundai-core) B1, 140, Sajik-daero, Seowon-gu, Cheongju-si,
hungcheongbuk-do, 28647, Republic of Korea. | | |
| (72) | YOO, Hyuk; JUNG, Tae-Jin; AN, Sung-Cheol and YOO, Moon-Soo | | |
| (74) | CONCETTI-LAO CO., LTD | | |
| (55) | | | |



Front view



Back view







Right view

Top view

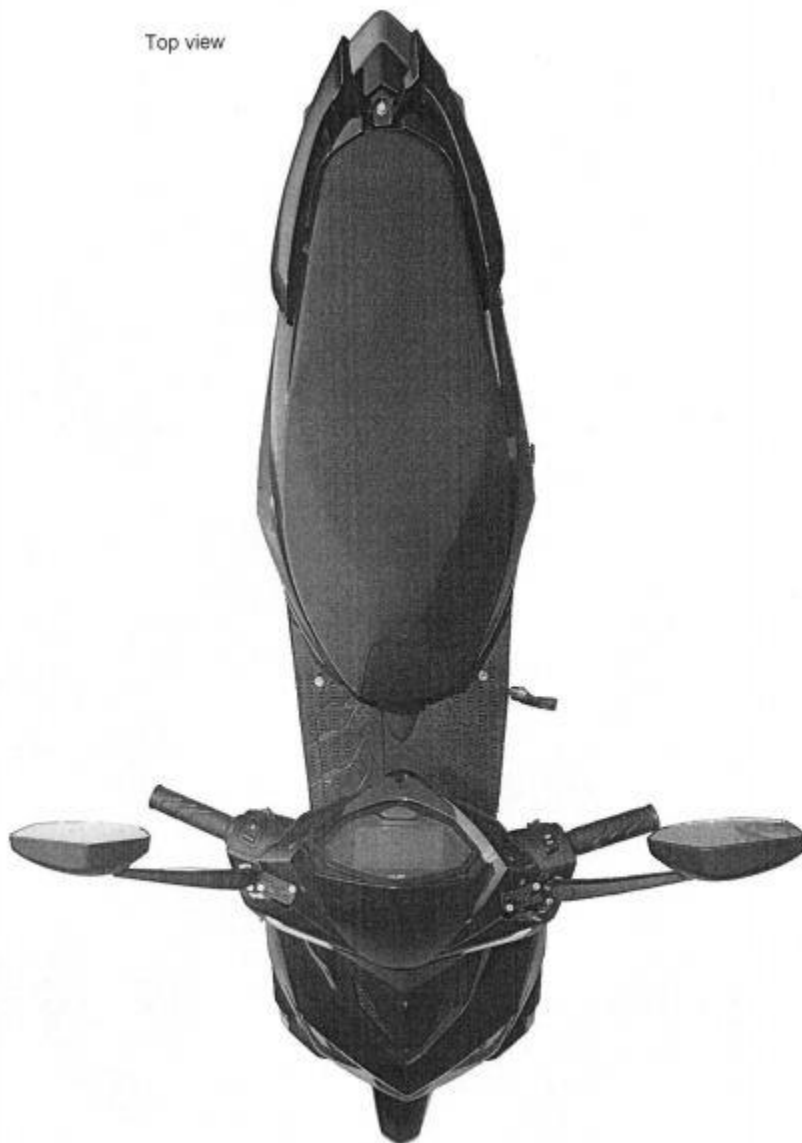

- | | | | |
|------|---|------|------------|
| (11) | No. 523 | (21) | ID 523 |
| (15) | 17/03/2022 | (22) | 20/09/2019 |
| (28) | | (17) | 20/09/2024 |
| (30) | | (51) | 12-11 |
| (54) | "Electric bike" | | |
| (71) | MBI Co., Ltd.
(Sachang-dong, Hyundai-core) B1, 140, Sajik-daero, Seowon-gu, Cheongju-si,
Chungcheongbuk-do, 28647, Republic of Korea. | | |
| (72) | YOO, Hyuk; JUNG, Tae-Jin; AN, Sung-Cheol and YOO, Moon-Soo | | |
| (74) | CONCETTI-LAO CO., LTD | | |
| (55) | | | |



Front view





Left view





Right view

Top view

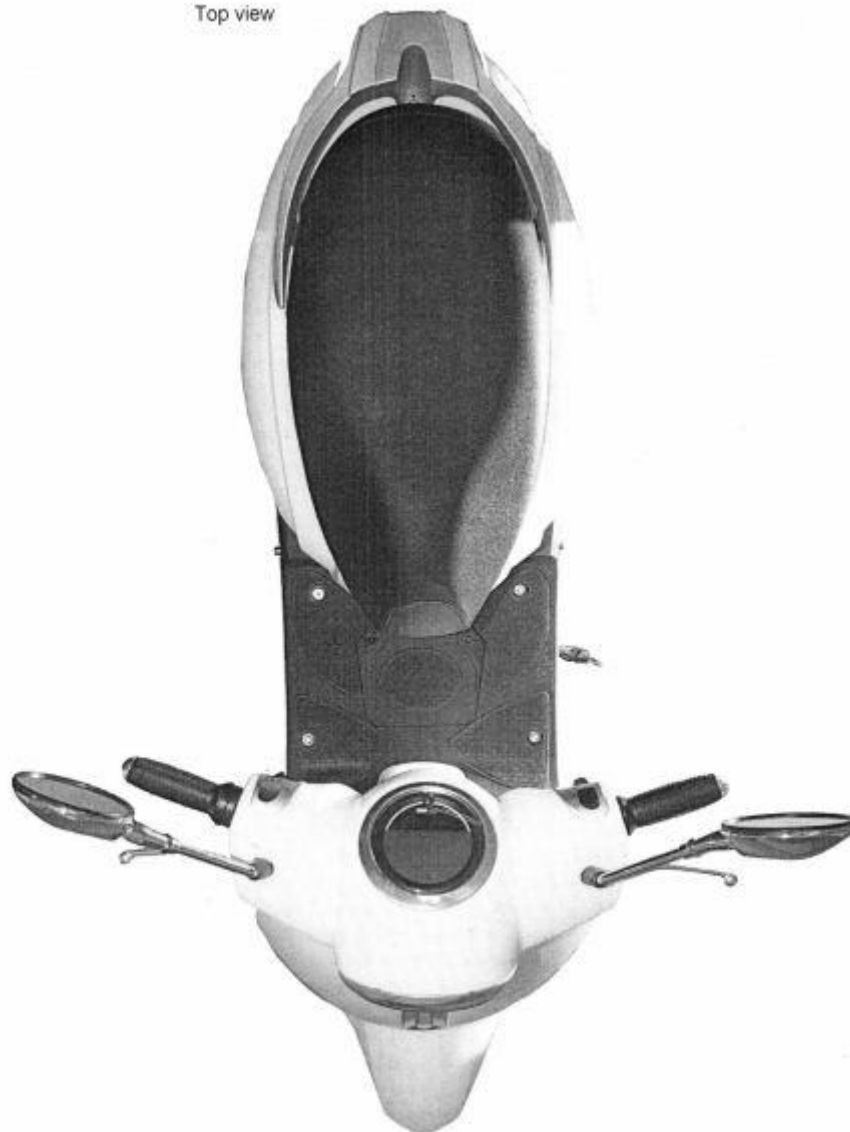

- | | | | |
|------|--|------|------------|
| (11) | No. 524 | (21) | ID 524 |
| (15) | 17/03/2022 | (22) | 20/09/2019 |
| (28) | | (17) | 20/09/2024 |
| (30) | | (51) | 12-11 |
| (54) | "Electric bike" | | |
| (71) | MBI Co., Ltd.
(Sachang-dong, Hyundai-core) 81, 140, Saiik-daero, Seowon-gu, Cheongju-si,
Chungcheongbuk-do, 28647, Republi of Korea. | | |
| (72) | JUNG, Tae-Jin; AN, Sung-Cheol; yOO, Moon-soo and YOO, HYuk | | |
| (74) | CONCETTI-LAO CO., LTD | | |
| (55) | | | |



FRONT VIEW



Back view







Right view



- | | | | |
|------|---|------|------------|
| (11) | No. 525 | (21) | ID 525 |
| (15) | 17/03/2022 | (22) | 20/09/2019 |
| (28) | | (17) | 20/09/2024 |
| (30) | | (51) | 15-01 |
| (54) | "Transmission" | | |
| (71) | MBI Co., Ltd.
(Sachang-dong, Hyundai-core) B1, 140, S aJik-daero, Seowon-gu, Cheongju-si,
Chungcheongbuk-do, 28647, Republic of Korea. | | |
| (72) | YOO, Hyuk; JUNG, Tae-Jin; YOO, Moon-Soo and AN, Sung-Che | | |
| (74) | CONCETTI-LAO CO., LTD | | |
| (55) | | | |

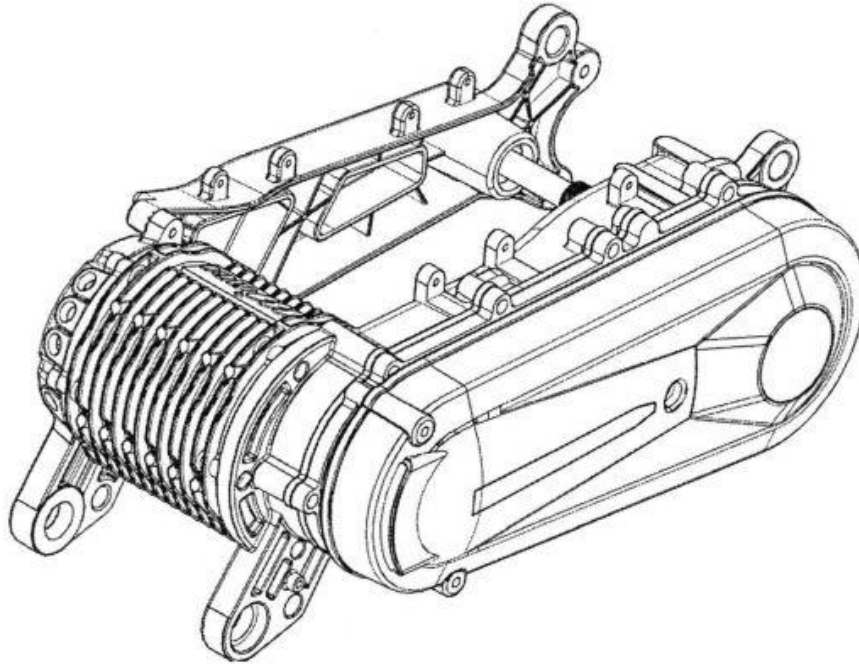

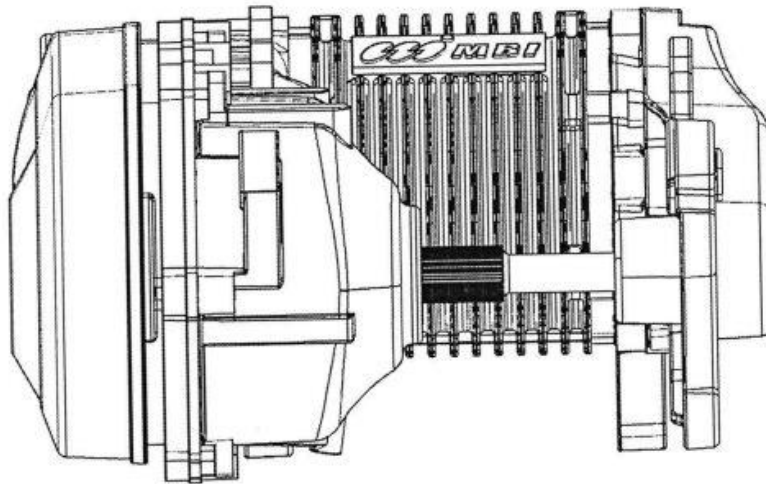
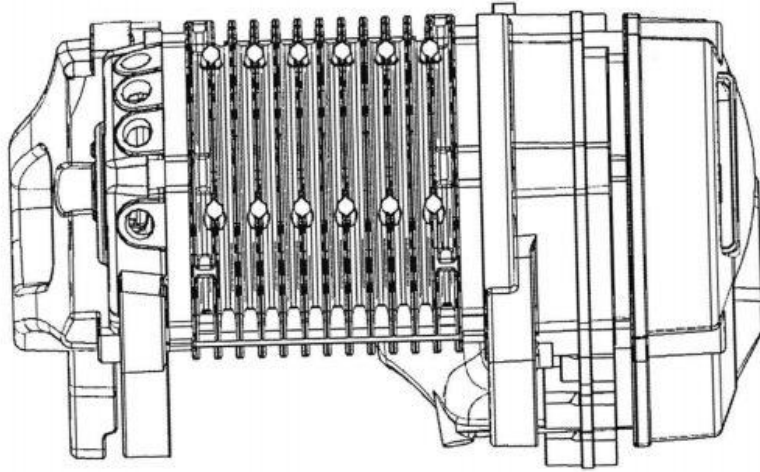

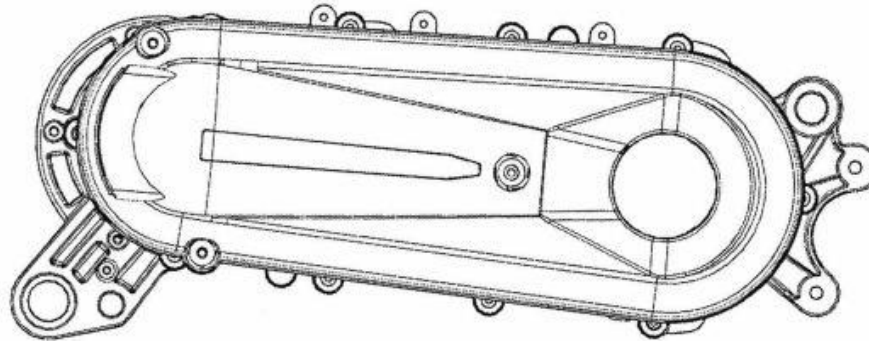
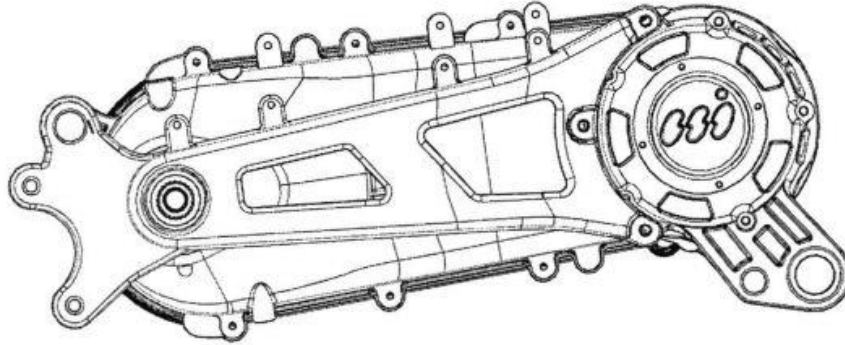

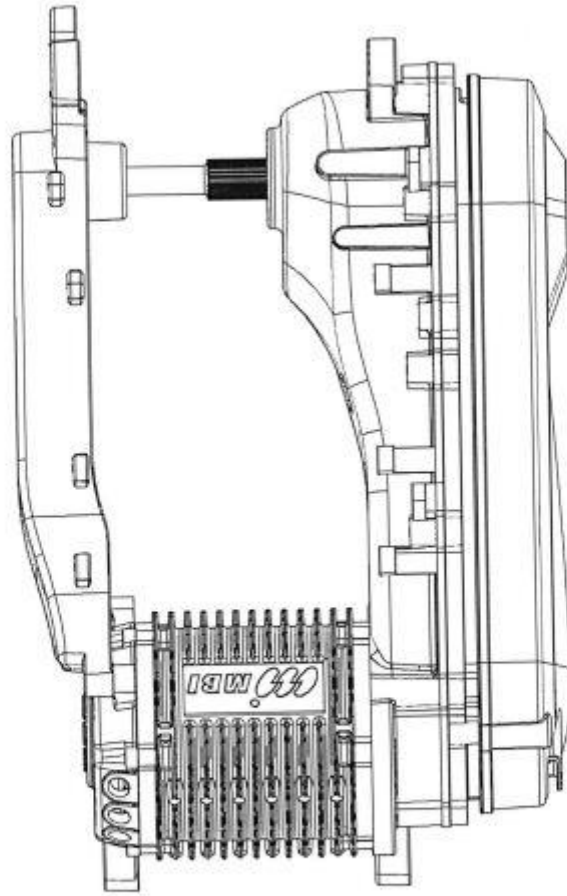

Top view

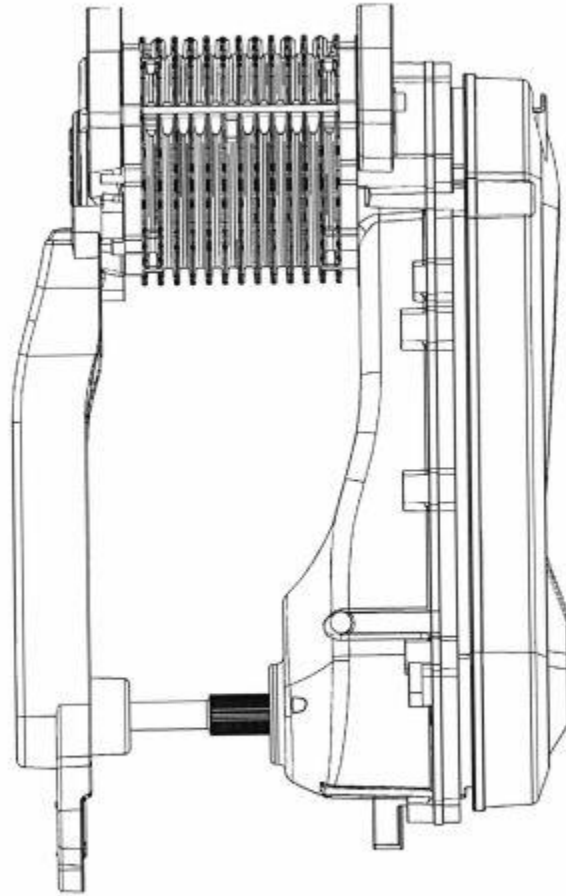

Bottom view

- (11) No. 538 (21) ID 538
(15) 17/03/2022 (22) 23/04/2020
(28) (17) 23/04/2025
(30) (51) 09-07
(54) Lid for bowl getting milk from rubber trees
(71) CONG TY TNHH KHANH HUNG
24 Le Thiet, Phuong Phu Tho Hoa, quan Tan Phu, thanh pho Ho Chi Minh, Vietnam.
(72) Pham Cong Khanh (Mr.)
(74) LAO TRADEMARK AGENCY (LAO IP AGENCY)
(55)

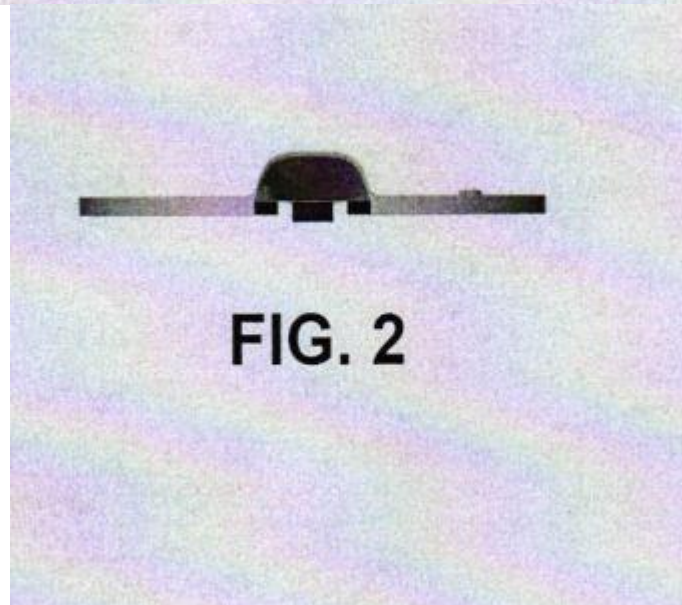
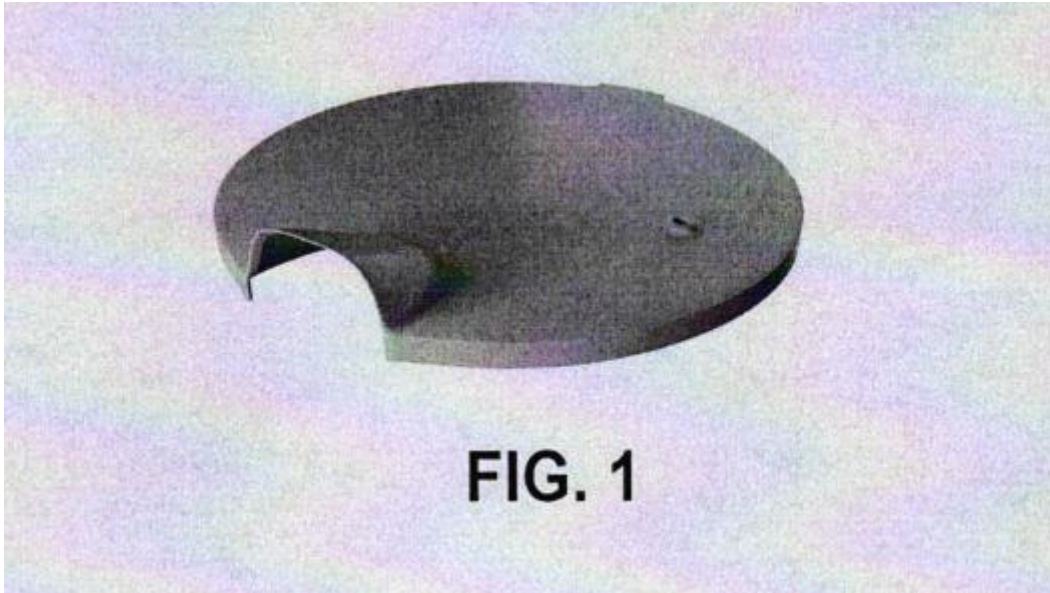

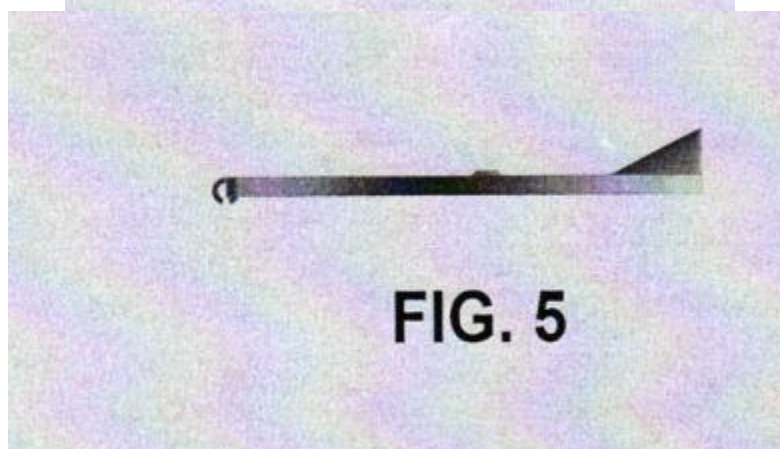
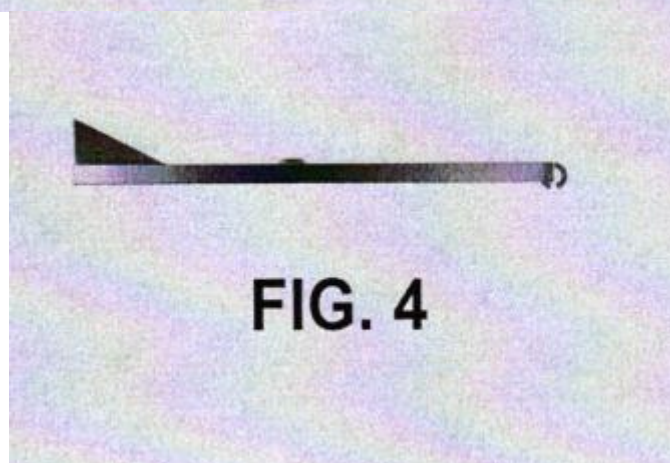
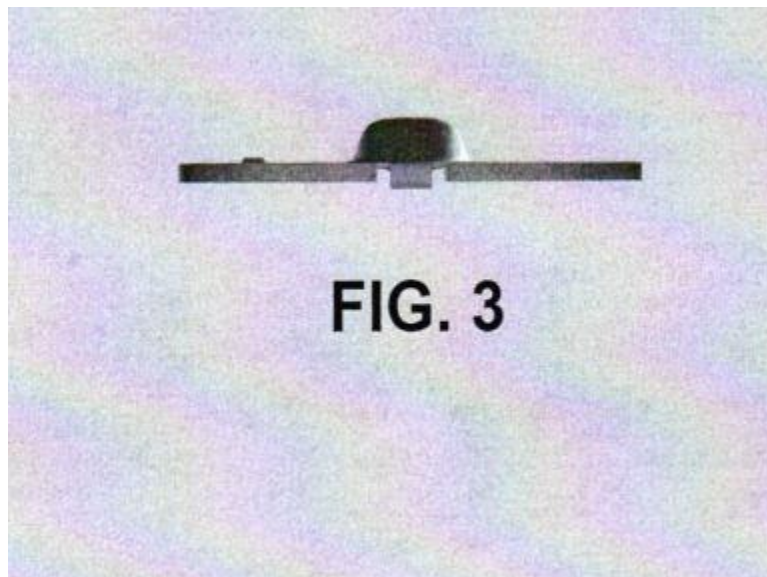

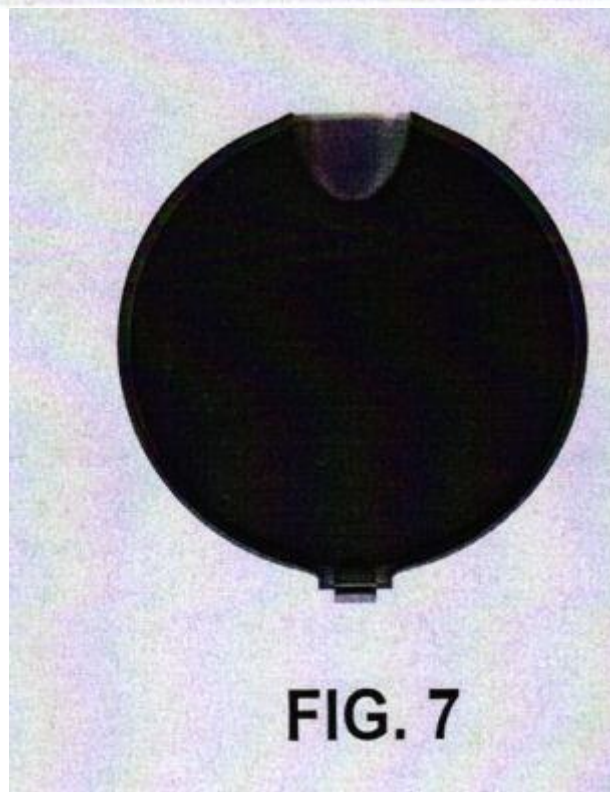
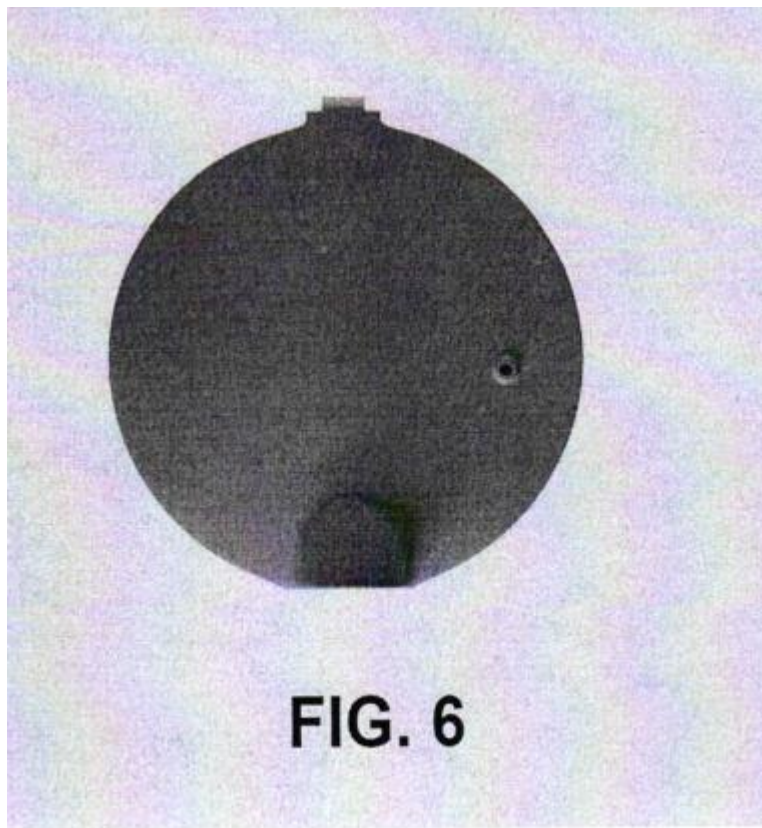

- (11) No. 539 (21) ID 539
(15) 17/03/2022 (22) 23/04/2020
(28) (17) 23/04/2025
(30) (51) 09-07
(54) Lid for bowl getting milk from rubber trees
(71) CONG TY TNHH KHANH HUNG
24 Le Thiet, phuong Phu Tho Hoa, quan Tan phu, thanh pho Ho Chi Minh, Vietnam.
(72) Pham Cong Khanh (Mr.)
(74) LAO TRADEMARK AGENCY (LAO IP AGENCY)
(55)

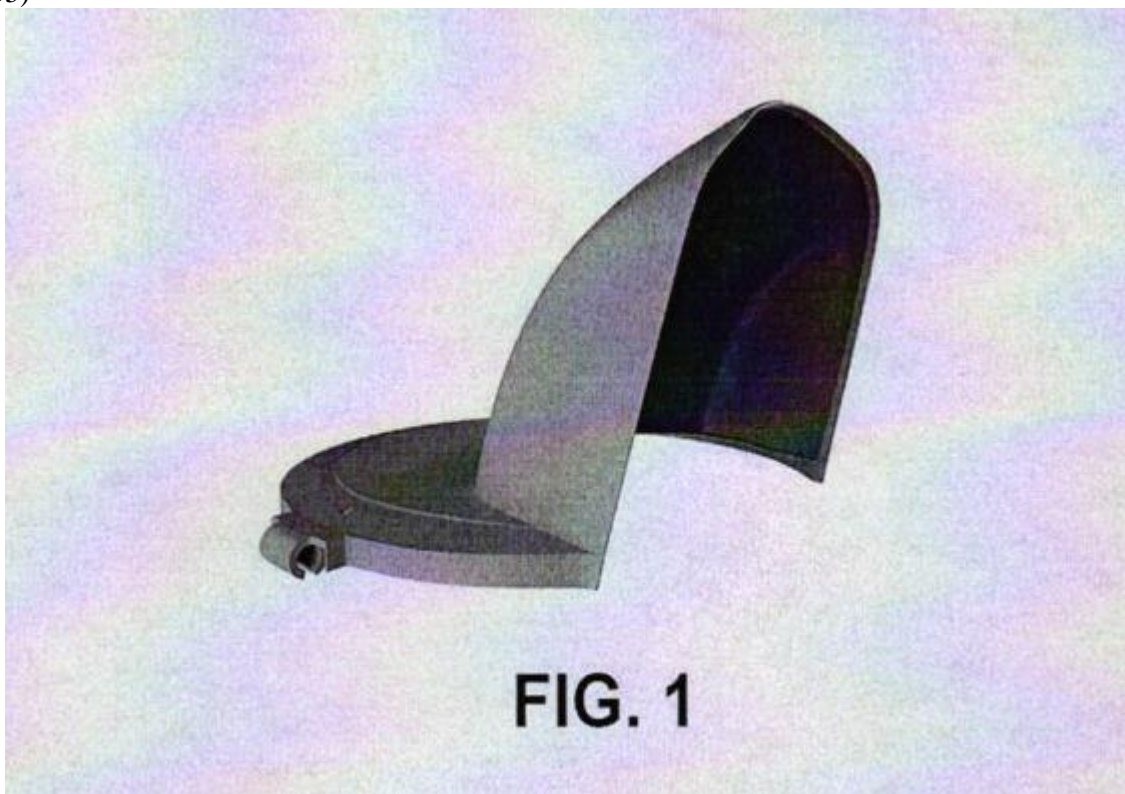



FIG. 2

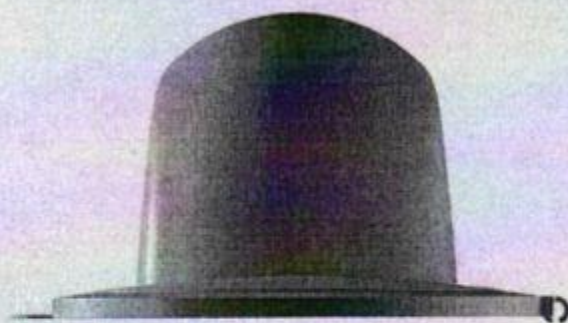

FIG. 3

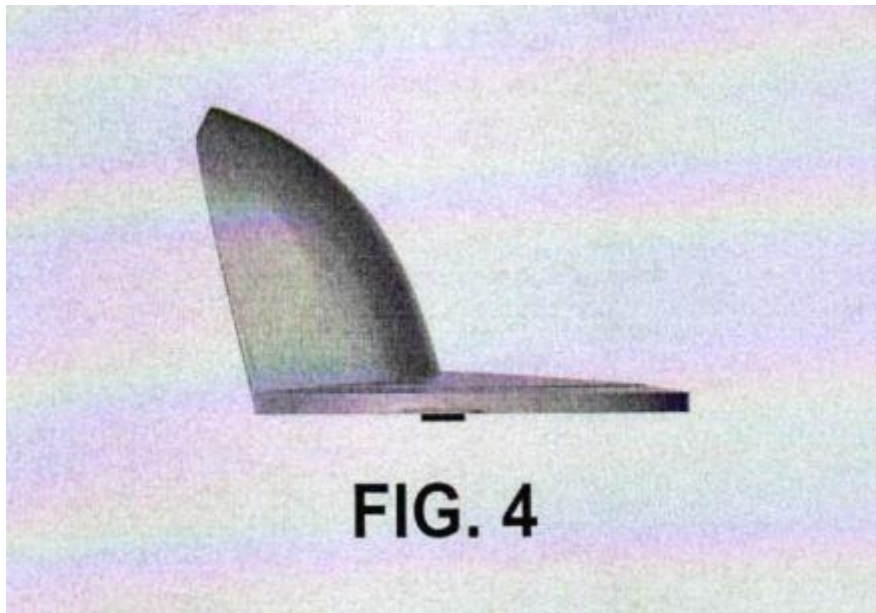

FIG. 4

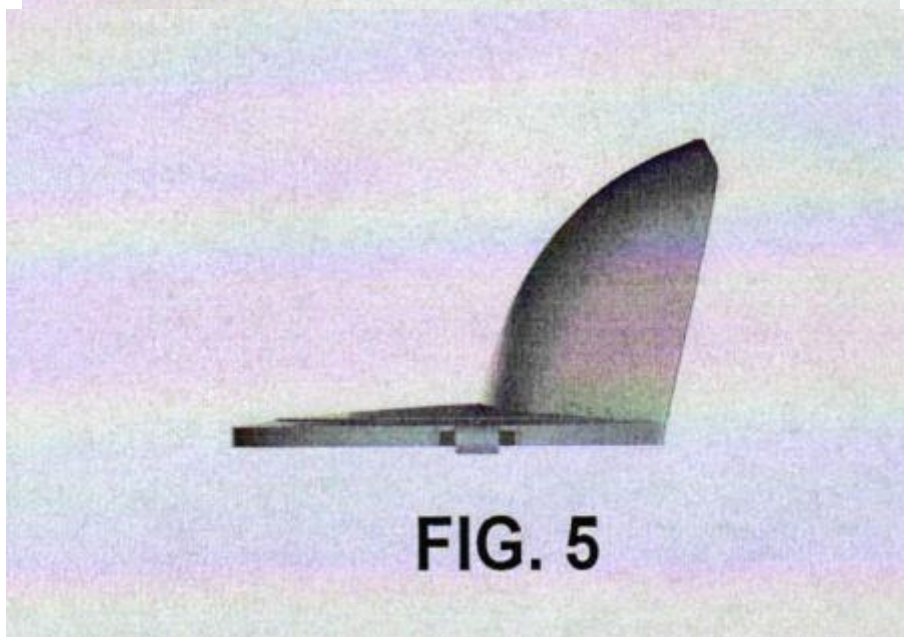
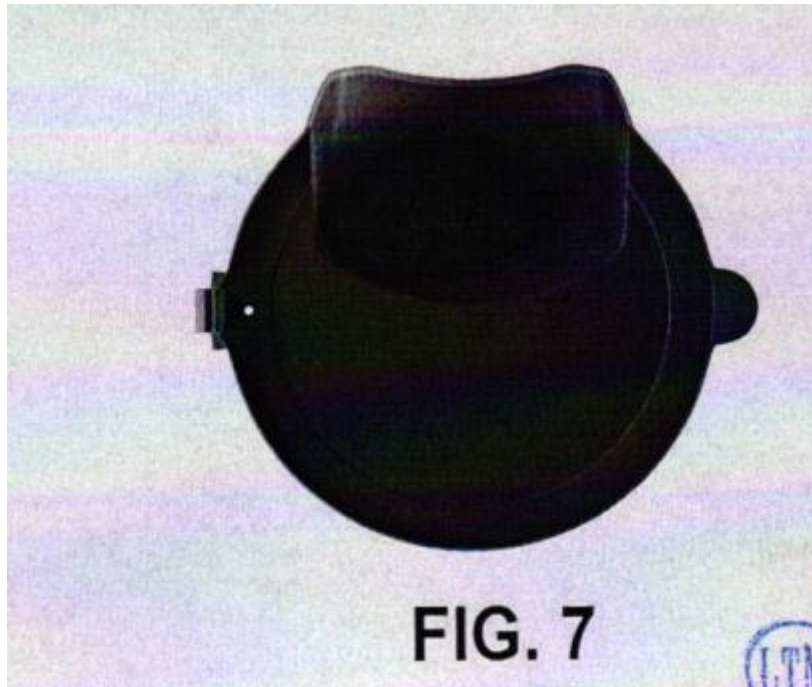
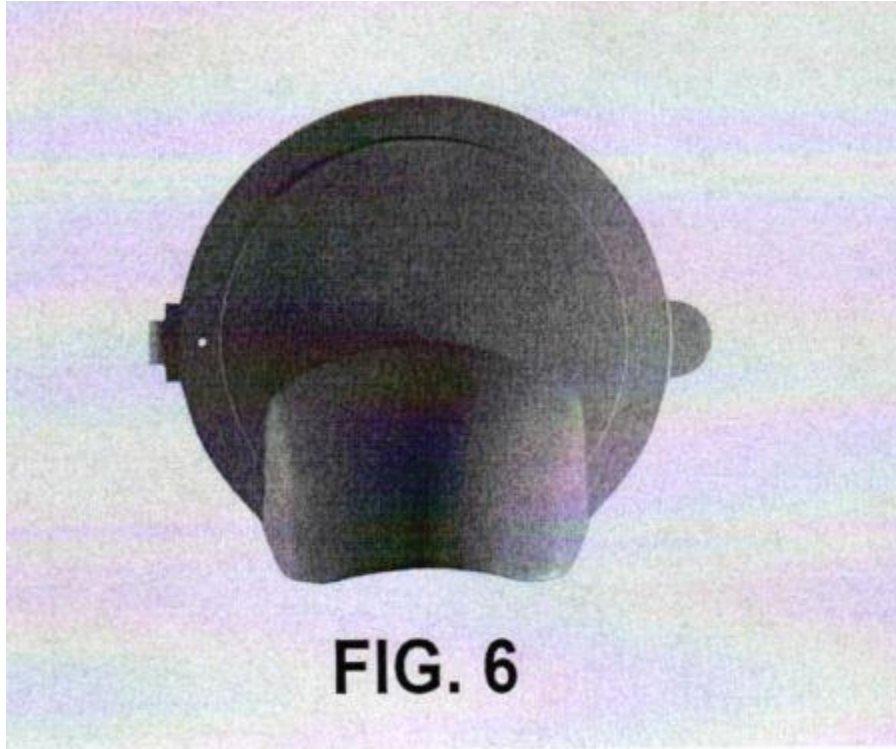

FIG. 5



ພາກທີ II
(Part II)
ແບບອຸດສາຫະກຳ
(Industrial Design)

2. ຜົນການຈົດທະບຽນ
(Registration)

ຄຳອະທິບາຍກ່ຽວກັບລະຫັດຫຍໍ້
(Introduction of Codes)

- (11) ເລກທີ ຈົດທະບຽນ (Registration Number)
- (15) ວັນທີ ຈົດທະບຽນ (Registration Date)
- (21) ເລກທີ ຍືນຄຳຮ້ອງ (Filing Number)
- (22) ວັນທີ ຍືນຄຳຮ້ອງ (Filing Date)
- (30) ວັນທີ ບຸລິມາສິດ (Priority Date)
- (17) ວັນທີ ໝົດອາຍຸ (Expiration Date)
- (51) ໝວດ (Locarno Classification)
- (54) ຊື່ຂອງແບບອຸດສາຫະກຳ (Title)
- (71) ຊື່ ແລະ ທີ່ຢູ່ ຂອງເຈົ້າຂອງ (Owner Name and Address)
- (72) ຊື່ຜູ້ອອກແບບ (Designer Name)
- (74) ຊື່ຕົວແທນ (Representative Name)
- (55) ຮູບພາບ (Pictures)

ພາກທີ II

(Part II)

ແບບອຸດສາຫະກຳ

(Industrial Design)

3. ການປ່ຽນແປງ

(Changes)

ພາກທີ II

(Part II)

ແບບອຸດສາຫະກຳ

(Industrial Design)

4. ການດັດແກ້

(Amendments)

ພາກທີ III
(Part III)
ເຄື່ອງໝາຍການຄ້າ
Trademarks

1. ຄໍາຮ້ອງ
(Applications)

ຄໍາອະທິບາຍກ່ຽວກັບລະຫັດຫຍໍ້
(Introduction of Codes)

- (540) ເຄື່ອງໝາຍການຄ້າ (Trademark)
- (511) ໝວດ (Nice Classification)
- (210) ເລກທີ ຄໍາຮ້ອງ (Number of the application)
- (220) ວັນທີ ຄໍາຮ້ອງ (Date of filing of the application)
- (732) ຊື່ ແລະ ທີ່ຢູ່ ຂອງຜູ້ຍື່ນຄໍາຮ້ອງ (Name and Address of applicant)

(540)



(511) 35

(210) No. 46601

(220) 31/12/2021

(732) ທ່ານ ຄຳກ້ອນ ໄຊສິງຄາມ

ບ້ານ ໂພນສະອາດ, ເມືອງປາກຊັນ, ແຂວງ ບໍລິຄຳໄຊ,
ສປປ ລາວ.

(540)



(511) 04 and 37

(210) No. 46620

(220) 11/01/2022

(732) ບໍລິສັດ ການຄ້າເຊື້ອໄຟ ເປໂຕເຄມີລາວ ຈຳກັດຜູ້ດຽວ

ຖະໜົນຄູວຽງ, ບ້ານໜອງຈັນ, ເມືອງສີສັດຕະນາກ,
ນະຄອນຫຼວງວຽງຈັນ, ສປປ ລາວ

(540)



(511) 35

(210) No. 46643

(220) 21/01/2022

(732) ບໍລິສັດ ລາວຢີເຊິງ ຈຳກັດຜູ້ດຽວ

ບ້ານ ປາກທ້າງ, ເມືອງສີໂຄດຕະບອງ,

ນະຄອນຫຼວງວຽງຈັນ, ສປປ ລາວ.

(540)



(511) 05

(210) No. 46653

(220) 25/01/2022

(732) ບໍລິສັດ ສຖານິຢາພື້ນເມືອງ ຈຳກັດ (ທ່ານ ເຊິນຊາງຊິງ)

ບ້ານ ໂພນໄຊສະຫວ່າງ, ເມືອງນ້ຳທາ, ແຂວງ

ຫຼວງນ້ຳທາ, ສປປ ລາວ

ພາກທີ III

(Part III)

ເຄື່ອງໝາຍການຄ້າ

Trademarks

2. ຜົນການຈົດທະບຽນ

(Registration)

ຄຳອະທິບາຍກ່ຽວກັບລະຫັດຫຍໍ້

(Introduction of Codes)

- (540) ເຄື່ອງໝາຍການຄ້າ (Trademark)
- (511) ໝວດ (Nice Classification)
- (210) ເລກທີ ຄຳຮ້ອງ (Number of the application)
- (220) ວັນທີ ຄຳຮ້ອງ (Date of filing of the application)
- (732) ຊື່ ແລະ ທີ່ຢູ່ ຂອງຜູ້ຍື່ນຄຳຮ້ອງ (Name and Address of applicant)
- (111) ເລກທີ ການຈົດທະບຽນເຄື່ອງໝາຍການຄ້າ (Number of the registration)
- (180) ວັນໝົດອາຍຸຂອງການຈົດທະບຽນ (Expiration date of the registration)

(540)

REAL MAGIC

(511) 32

(210) No. 46261

(220) 28/09/2021

(732) The Coca-Cola Company

One Coca-Cola Plaza, Atlanta, Georgia

30313, United States Of America.

(111) No. 53369

(180) 28/09/2031

(540)



(511) 35

(210) No. 46263

(220) 29/09/2021

(732) Central US Trading Ltd.

112 North Curry Street, Carson City, NV

89703-4934, United States Of America

(111) No. 53370

(180) 29/09/2031

(540)



(511) 36

(210) No. 46264

(220) 29/09/2021

(732) Central US Trading Ltd.

112 North Curry Street, Carson City, NV

89703-4934, United States Of America

(111) No. 53371

(180) 29/09/2031

(540)



(511) 35

(210) No. 46265

(220) 29/09/2021

(732) Central US Trading Ltd.

112 North Curry Street, Carson City, NV

89703-4934, United States Of America

(111) No. 53372

(180) 29/09/2031

(540)



(511) 36

(210) No. 46266

(220) 29/09/2021

(732) Central US Trading Ltd.

112 North Curry Street, Carson City, NV

89703-4934, United States Of America

(111) No. 53373

(180) 29/09/2031

(540)



(511) 35

(210) No. 46267

(220) 29/09/2021

(732) Central US Trading Ltd.

112 North Curry Street, Carson City, NV

89703-4934, United States Of America

(111) No. 53374

(180) 29/09/2031

(540)



(511) 36

(210) No. 46268

(220) 29/09/2021

(732) Central US Trading Ltd.

112 North Curry Street, Carson City, NV

89703-4934, United States Of America

(111) No. 53375

(180) 29/09/2031

(540)



(511) 35

(210) No. 46269

(220) 29/09/2021

(732) Central US Trading Ltd.

112 North Curry Street, Carson City, NV

89703-4934, United States Of America

(111) No. 53376

(180) 29/09/2031

(540)



(511) 36

(210) No. 46270

(220) 29/09/2021

(732) Central US Trading Ltd.

112 North Curry Street, Carson City, NV

89703-4934, United States Of America

(111) No. 53377

(180) 29/09/2031

(540)

SOLFILI

(511) 35

(210) No. 46273

(220) 30/09/2021

(732) SOLFILI PERFORMANCE PARTS SDN.

BHD. No.40, Jalan TPPS, Taman

Perindustrian Putra,47130 Puchong,

Selangor, Malaysia, Malaysia

(111) No. 53378

(180) 30/09/2031

(540)

SOLFILI

(511) 12

(210) No. 46274

(220) 30/09/2021

(732) SOLFILI PERFORMANCE PARTS SDN.

BHD. No.40, Jalan TPPS, Taman

Perindustrian Putra,47130 Puchong,

Selangor, Malaysia, Malaysia

(111) No. 53379

(180) 30/09/2031

(540)



HISTORY

(511) 41

(210) No. 46226

(220) 22/09/2021

(732) A&E Television Networks.

LLC 235 East 45th Street, New York,

New York 10017, United States of

America, United States Of America

(111) No. 53380

(180) 22/09/2031

(540)



(511) 38

(210) No. 46227

(220) 22/09/2021

(732) A&E Television Networks.

LLC 235 East 45th Street. New York.

New York 10017. United States of

America, United States Of America

(111) No. 53381

(180) 22/09/2031

(540)



(511) 09

(210) No. 46228

(220) 22/09/2021

(732) A&E Television Network.

LLC 235 East 45th Street, New York,

New York 10017, United States of

America, United States Of America

(111) No. 53382

(180) 22/09/2031

(540)



(511) 30

(210) No. 46230

(220) 24/09/2021

(732) CK Corporation Co.. Ltd.

128 Moo 5 Nayung, Sithat District, Udon

Thani 4123 0 Thailand, Thailand

(111) No. 53383

(180) 24/09/2031

(540)



(511) 30

(210) No. 46231

(220) 24/09/2021

(732) CK Corporation Co.. Ltd.

128 Moo 5 Nayung, Sithat District, Udon

Thani 4123 0 Thailand, Thailand

(111) No. 53384

(180) 24/09/2031

(540)



(511) 35

(210) No. 46232

(220) 24/09/2021

(732) ບໍລິສັດ ບິກແບງ ອິນເຕີເນເຊັນນໍ ເທຣດ ຈຳກັດ

ບ້ານ ວັດໄຕນ້ອຍທົ່ງ, ເມືອງສີໂຄດຕະບອງ,

ນະຄອນຫຼວງວຽງຈັນ, ສປປ ລາວ

(111) No. 53390

(180) 24/09/2031

ພາກທີ III
(Part III)
ເຄື່ອງໝາຍການຄ້າ
Trademarks

3. ການຕໍ່ອາຍຸ
(Renewal)

ຄຳອະທິບາຍກ່ຽວກັບລະຫັດຫຍໍ້
(Introduction of Codes)

- (540) ເຄື່ອງໝາຍການຄ້າ (Trademark)
- (511) ໝວດ (Nice Classification)
- (210) ເລກທີ ຄຳຮ້ອງ (Number of the application)
- (220) ວັນທີ ຄຳຮ້ອງ (Date of filing of the application)
- (732) ຊື່ ແລະ ທີ່ຢູ່ ຂອງຜູ້ຍື່ນຄຳຮ້ອງ (Name and Address of applicant)
- (111) ເລກທີການຈັດທະບຽນເຄື່ອງໝາຍການຄ້າ (Number of the registration)
- (180) ການຕໍ່ອາຍຸການຈັດທະບຽນ (Expiration date of the renewal)

(540) Renewal

KIT KAT

(511) 30

(210) No. 427

(220) 23/03/1992

(732) Societe des Produits Nestle

S.A Vevey, Switzerland

(111) No. 402

(180) 23/03/2032

(540) Renewal

LION

(511) 30

(210) No. 428

(220) 23/03/1992

(732) Societe des Produits Nestle

S.A Vevey, Switzerland

(111) No. 403

(180) 23/03/2032

(540) Renewal

SMARTIES

(511) 30

(210) No. 434

(220) 23/03/1992

(732) Societe des Produits Nestle

S.A 1800 Vevey, Switzerland

(111) No. 409

(180) 23/03/2032

(540) Renewal

ACTIFED

(511) 05

(210) No. 597

(220) 17/02/1992

(732) Glaxo Group Limited

980 Great West Road, Brentford, Middlesex,

TW8 9GS, United Kingdom

(111) No. 594

(180) 17/02/2032

(540) Renewal

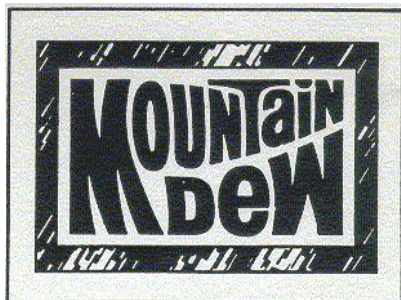

(511) 32

(210) No. 619

(220) 17/02/1992

(732) PEPSICO , INC.,

700 Andeson Hill Road, Purchase, New York
10577, United States Of America

(111) No. 616

(180) 17/02/2032

(540) Renewal



(511) 32

(210) No. 620

(220) 17/02/1992

(732) PEPSICO , INC.,

700 Andeson Hill Road, Purchase, New York
10577, United States Of America

(111) No. 617

(180) 17/02/2032

(540) Renewal



(511) 32

(210) No. 621

(220) 17/02/1992

(732) PEPSICO , INC.,

700 Andeson Hill Road, Purchase, New York
10577, United States Of America

(111) No. 618

(180) 17/02/2032

(540) Renewal

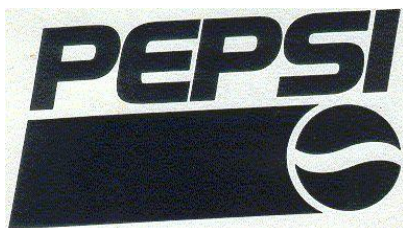

(511) 32

(210) No. 622

(220) 17/02/1992

(732) PEPSICO , INC.,

700 Andeson Hill Road, Purchase, New York
10577, United States Of America

(111) No. 619

(180) 17/02/2032

(540) Renewal



(511) 32

(210) No. 625

(220) 17/02/1992

(732) PEPSICO , INC.,

700 Andeson Hill Road, Purchase, New York
10577, United States Of America

(111) No. 622

(180) 17/02/2032

(540) Renewal



(511) 32

(210) No. 680

(220) 12/03/1992

(732) Amstel Brouwerij

B.V. 2e Weteringplantsoen 21, 1017 ZD
Amsterdam, Netherlands

(111) No. 672

(180) 12/03/2032

(540) Renewal

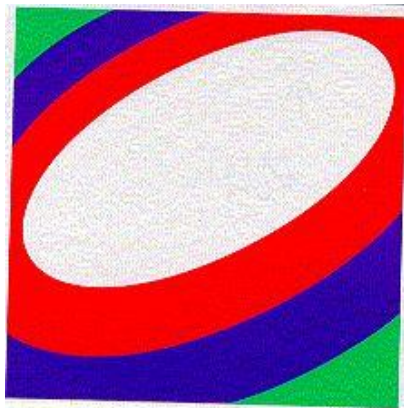

(511) 04

(210) No. 941

(220) 27/05/1992

(732) COSMO ENERGY HOLDINGS CO., LTD.

1-1-1, Shibaura, Minato-ku, Tokyo, Japan

(111) No. 878

(180) 27/05/2032

(540) Renewal

COSMO

(511) 04

(210) No. 942

(220) 27/05/1992

(732) COSMO ENERGY HOLDINGS CO., LTD.

1-1-1, Shibaura, Minato-ku, Tokyo, Japan

(111) No. 879

(180) 27/05/2032

(540) Renewal

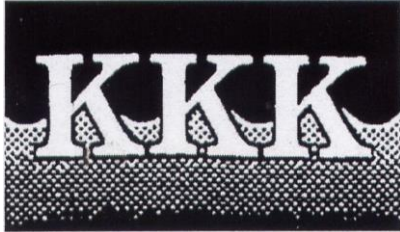

(511) 12

(210) No. 9145

(220) 14/01/2002

(732) MR. CHANCHAI SRIPRASERTYING

325/1-3 Issaraparb Road, Amphur

Bangkokyai, Bangkok 10600, Thailand

(111) No. 8736

(180) 14/01/2032

(540) Renewal

SPECSAVERS

(511) 09

(210) No. 9146

(220) 21/01/2002

(732) SPECSAVERS

B.V. Postbus 1229, NL-1270BE Huizen,

Netherlands

(111) No. 8737

(180) 21/01/2022

(540) Renewal



(511) 30

(210) No. 9161

(220) 28/01/2002

(732) LEA & PERRINS LIMITED

The Shard,32 London Bridge Street, London
SE1 9SG United Kingdom, United Kingdom

(111) No. 8747

(180) 28/01/2032

(540) Renewal

VESRAH

(511) 12

(210) No. 9239

(220) 20/02/2002

(732) Vesrah Co., Inc

Shinjuku 1-23-9, Shinjuku-ku, Tokyo, Japan

(111) No. 8769

(180) 20/02/2032

(540) Renewal

UNIQLO

(511) 25

(210) No. 9256

(220) 03/01/2002

(732) Kabushiki Kaisha Fast Retailing

10717-1, Sayama, Yamaguchi City,
yamaguchi, Japan

(111) No. 8783

(180) 03/01/2032

(540) Renewal



(511) 32

(210) No. 9217

(220) 02/12/2002

(732) BUDĚJOVICKÝ BUDVAR, NÁRODNÍ

PODNIK, BUDWEISER

BUDVAR, NATIONAL CORPORATION.

BUDWEISER BUDVAR, ENTREPRISE

NATIONALE K. SVĚTLÉ 512/4, ČESKÉ

BUDĚJOVICE 3, 370 04 ČESKÉ

BUDĚJOVICE, CZECH REPUBLIC

(111) No. 8826

(180) 02/12/2032

(540) Renewal

**BUDEJOVICKY
BUDVAR &
STYLIZED**

(511) 32

(210) No. 9218

(220) 02/12/2002

(732) BUDĚJOVICKÝ BUDVAR, NÁRODNÍ
PODNIK, BUDWEISER BUDVAR,
NATIONAL CORPORATION
BUDWEISER BUDVAR, ENTREPRISE
NATIONALE K. SVĚTLÉ 512/4, ČESKÉ
BUDĚJOVICE 3, 370 04 ČESKÉ
BUDĚJOVICE, CZECH REPUBLIC.

(111) No. 8827

(180) 02/12/2032

(540) Renewal

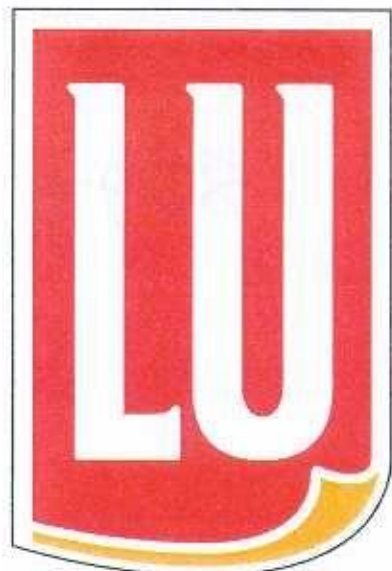

(511) 29

(210) No. 23720

(220) 22/04/2011

(732) GENERLE BISCUIT

6 Av Reaumur, 92140 Clamart, France

(111) No. 23102

(180) 25/06/2031

(540) Renewal

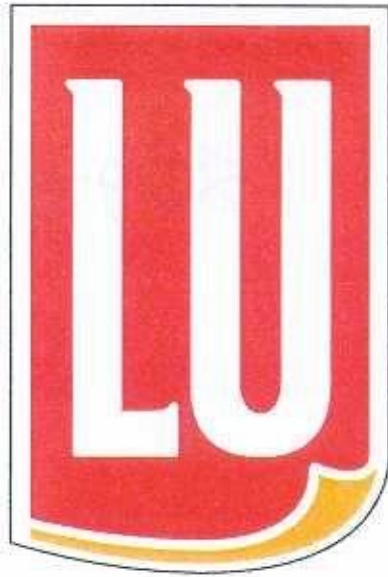

(511) 30

(210) No. 23917

(220) 17/05/2011

(732) GENERALE BISCUIT

6 Av Reaumur, 92140 Clamart, France

(111) No. 23302

(180) 25/06/2031

(540) Renewal



(511) 20

(210) No. 24960

(220) 25/10/2011

(732) JAYA TEXTILE CO., LTD

45/1 Moo 7, Tambol Klongmadaue, Amphur

Kratumban, Samutsakorn Province 74110,

Thailand

(111) No. 24336

(180) 03/04/2032

(540) Renewal



(511) 24

(210) No. 24961

(220) 25/10/2011

(732) JAYA TEXTILE CO., LTD

45/1 Moo 7, Tambol Klongmadaue, Amphur
Kratumban, Samutsakorn Province 74110,
Thailand

(111) No. 24337

(180) 03/04/2032

(540) Renewal

SAIGON

(511) 20

(210) No. 25019

(220) 04/11/2011

(732) CONG TY CO PHAN CAO SU SAI GON-
KYMDAN (SAIGON-KYMDAN RUBBER
STOCK COMPANY)

28 Binh Thoi, District 11, Ho Chi Minh City,
Vietnam

(111) No. 24358

(180) 04/11/2031

(540) Renewal

SEIKO ASTRON

(511) 14

(210) No. 25347

(220) 08/12/2011

(732) SEIKO HOLDINGS KABUSHIKI KAISHA
(TRADING AS SEIKO HOLDINGS
CORPORATION)

5-11, Ginza 4-chome, Chuo-ku, Tokyo, Japan

(111) No. 24626

(180) 08/12/2031

(540) Renewal

 **ARISTON**

(511) 07

(210) No. 25355

(220) 09/12/2011

(732) Wirlpool EMEA

S.p.A. Via Carlo Pisacane, 1-20016 Pero

(MI) Italy.

(111) No. 24633

(180) 09/12/2031

(540) Renewal



(511) 09

(210) No. 25356

(220) 09/12/2011

(732) Wirlpool EMEA

S.p.A. Via Carlo Pisacane, 1-20016 Pero
(MI) Italy.

(111) No. 24634

(180) 09/12/2031

(540) Renewal



(511) 11

(210) No. 25357

(220) 09/12/2011

(732) Wirlpool EMEA

S.p.A. Via Carlo Pisacane, 1-20016 Pero
(MI) Italy.

(111) No. 24635

(180) 09/12/2031

(540) Renewal

 ARISTON

(511) 37

(210) No. 25358

(220) 09/12/2011

(732) Wirlpool EMEA

S.p.A. Via Carlo Pisacane, 1-20016 Pero
(MI) Italy.

(111) No. 24636

(180) 09/12/2031

(540) Renewal

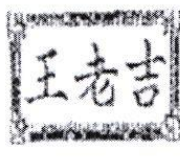
王老吉 

(511) 05

(210) No. 25376

(220) 13/12/2011

(732) MULTI ACCESS LIMITED

Palm Grove House, P.O. Box 438, Road
Town, Tortola, United Kingdom

(111) No. 24652

(180) 13/12/2031

(540) Renewal

王老吉

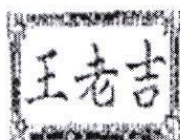

(511) 30

(210) No. 25377

(220) 13/12/2011

(732) MULTI ACCESS LIMITED

Palm Grove House, P.O. Box 438, Road
Town, Tortola, Virgin Islands (British)

(111) No. 24653

(180) 13/12/2031

(540) Renewal

王老吉

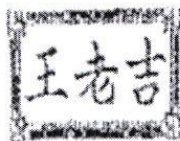

(511) 32

(210) No. 25378

(220) 13/12/2011

(732) MULTI ACCESS LIMITED

Palm Grove House, P.O. Box 438, Road
Town, Tortola, Virgin Islands (British)

(111) No. 24654

(180) 13/12/2031

(540) Renewal



(511) 33

(210) No. 25379

(220) 13/12/2011

(732) MULTI ACCESS LIMITED

Palm Grove House, P.O. Box 438, Road
Town, Tortola, Virgin Islands (British)

(111) No. 24655

(180) 13/12/2031

(540) Renewal

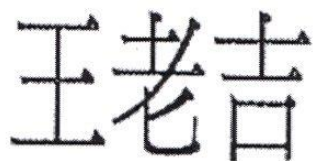

(511) 33

(210) No. 25380

(220) 13/12/2011

(732) MULTI ACCESS LIMITED

Palm Grove House, P.O. Box 438, Road
Town, Tortola, United Kingdom

(111) No. 24656

(180) 13/12/2031

(540) Renewal

WANG LAO JI

(511) 05

(210) No. 25381

(220) 13/12/2011

(732) MULTI ACCESS LIMITED

Palm Grove House, P.O. Box 438, Road Town,
Tortola, United Kingdom

(111) No. 24657

(180) 13/12/2031

(540) Renewal

WANG LAO JI

(511) 30

(210) No. 25382

(220) 13/12/2011

(732) MULTI ACCESS LIMITED

Palm Grove House, P.O. Box 438, Road Town,
Tortola, Virgin Islands (British)

(111) No. 24658

(180) 13/12/2031

(540) Renewal

WANG LAO JI

(511) 32

(210) No. 25383

(220) 13/12/2011

(732) MULTI ACCESS LIMITED

Palm Grove House, P.O. Box 438, Road Town,
Tortola, Virgin Islands (British)

(111) No. 24659

(180) 13/12/2031

(540) Renewal

WANG LAO JI

(511) 33

(210) No. 25384

(220) 13/12/2011

(732) MULTI ACCESS LIMITED

Palm Grove House, P.O. Box 438, Road Town,
Tortola, Virgin Islands (British)

(111) No. 24660

(180) 13/12/2031

(540) Renewal

WONG LO KAT

(511) 05

(210) No. 25385

(220) 13/12/2011

(732) MULTI ACCESS LIMITED

Palm Grove House, P.O. Box 438, Road Town,
Tortola, Virgin Islands (British)

(111) No. 24661

(180) 13/12/2031

(540) Renewal

WONG LO KAT

(511) 30

(210) No. 25386

(220) 13/12/2011

(732) MULTI ACCESS LIMITED

Palm Grove House, P.O. Box 438, Road Town,
Tortola, Virgin Islands (British)

(111) No. 24662

(180) 13/12/2031

(540) Renewal

WONG LO KAT

(511) 32

(210) No. 25387

(220) 13/12/2011

(732) MULTI ACCESS LIMITED

Palm Grove House, P.O. Box 438, Road Town,
Tortola, Virgin Islands (British)

(111) No. 24663

(180) 13/12/2031

(540) Renewal

WONG LO KAT

(511) 33

(210) No. 25388

(220) 13/12/2011

(732) MULTI ACCESS LIMITED

Palm Grove House, P.O. Box 438, Road Town,
Tortola, Virgin Islands (British)

(111) No. 24664

(180) 13/12/2031

(540) Renewal



(511) 29

(210) No. 25471

(220) 23/12/2011

(732) Molkerai Ammerland eG Oldenburger

Landstr. 1a, 26215 Wiefelstede-Dringenburg,
Germany

(111) No. 24715

(180) 23/12/2031

(540) Renewal

ALFARE

(511) 05

(210) No. 25307

(220) 06/12/2011

(732) SOCIETE DES PRODUITS NESTLE

S.A 1800 Vevey, Switzerland

(111) No. 24778

(180) 25/03/2032

(540) Renewal

ALFARE

(511) 29

(210) No. 25308

(220) 06/12/2011

(732) SOCIETE DES PRODUITS NESTLE

S.A 1800 Vevey, Switzerland

(111) No. 24779

(180) 25/03/2032

(540) Renewal

LACTOGEN

(511) 05

(210) No. 25314

(220) 06/12/2011

(732) SOCIETE DES PRODUITS NESTLE

S.A 1800 Vevey, Switzerland

(111) No. 24785

(180) 25/03/2032

(540) Renewal

LACTOGEN

(511) 29

(210) No. 25315

(220) 06/12/2011

(732) SOCIETE DES PRODUITS NESTLE

S.A 1800 Vevey, Switzerland

(111) No. 24786

(180) 25/03/2032

(540) Renewal

MILO

(511) 29

(210) No. 25316

(220) 06/12/2011

(732) SOCIETE DES PRODUITS NESTLE

S.A 1800 Vevey, Switzerland

(111) No. 24787

(180) 25/03/2032

(540) Renewal

MILO

(511) 30

(210) No. 25317

(220) 06/12/2011

(732) SOCIETE DES PRODUITS NESTLE

S.A 1800 Vevey, Switzerland

(111) No. 24788

(180) 25/03/2032

(540) Renewal

MILO

(511) 32

(210) No. 25318

(220) 06/12/2011

(732) SOCIETE DES PRODUITS NESTLE

S.A 1800 Vevey, Switzerland

(111) No. 24789

(180) 25/03/2032

(540) Renewal

NAN

(511) 05

(210) No. 25319

(220) 06/12/2011

(732) SOCIETE DES PRODUITS NESTLE

S.A 1800 Vevey, Switzerland

(111) No. 24790

(180) 25/03/2032

(540) Renewal

NAN

(511) 29

(210) No. 25320

(220) 06/12/2011

(732) SOCIETE DES PRODUITS NESTLE

S.A 1800 Vevey, Switzerland

(111) No. 24791

(180) 25/03/2032

(540) Renewal

NESCAFE

(511) 30

(210) No. 25321

(220) 06/12/2011

(732) SOCIETE DES PRODUITS NESTLE

S.A 1800 Vevey, Switzerland

(111) No. 24792

(180) 25/03/2032

(540) Renewal

NESCAFE

(511) 32

(210) No. 25322

(220) 06/12/2011

(732) SOCIETE DES PRODUITS NESTLE

S.A 1800 Vevey, Switzerland

(111) No. 24793

(180) 25/03/2032

(540) Renewal

NESLAC

(511) 05

(210) No. 25323

(220) 06/12/2011

(732) SOCIETE DES PRODUITS NESTLE

S.A 1800 Vevey, Switzerland

(111) No. 24794

(180) 25/03/2032

(540) Renewal

NESLAC

(511) 29

(210) No. 25324

(220) 06/12/2011

(732) SOCIETE DES PRODUITS NESTLE

S.A 1800 Vevey, Switzerland

(111) No. 24795

(180) 25/03/2032

(540) Renewal

NESQUIK

(511) 29

(210) No. 25325

(220) 06/12/2011

(732) SOCIETE DES PRODUITS NESTLE

S.A 1800 Vevey, Switzerland

(111) No. 24796

(180) 25/03/2032

(540) Renewal

NESQUIK

(511) 30

(210) No. 25326

(220) 06/12/2011

(732) SOCIETE DES PRODUITS NESTLE

S.A 1800 Vevey, Switzerland

(111) No. 24797

(180) 25/03/2032

(540) Renewal

NESTEA

(511) 30

(210) No. 25328

(220) 06/12/2011

(732) SOCIETE DES PRODUITS NESTLE

S.A 1800 Vevey, Switzerland

(111) No. 24799

(180) 25/03/2032

(540) Renewal

NESTEA

(511) 32

(210) No. 25329

(220) 06/12/2011

(732) SOCIETE DES PRODUITS NESTLE

S.A 1800 Vevey, Switzerland

(111) No. 24800

(180) 25/03/2032

(540) Renewal



(511) 30

(210) No. 25330

(220) 06/12/2011

(732) SOCIETE DES PRODUITS NESTLE S.A

1800 Vevey, Switzerland

(111) No. 24801

(180) 19/02/2032

(540) Renewal



(511) 32

(210) No. 25331

(220) 06/12/2011

(732) SOCIETE DES PRODUITS NESTLE

S.A 1800 Vevey, Switzerland

(111) No. 24802

(180) 19/02/2032

(540) Renewal

NESTOGEN

(511) 05

(210) No. 25336

(220) 06/12/2011

(732) SOCIETE DES PRODUITS NESTLE

S.A 1800 Vevey, Switzerland

(111) No. 24807

(180) 25/03/2032

(540) Renewal

NESTOGEN

(511) 29

(210) No. 25337

(220) 06/12/2011

(732) SOCIETE DES PRODUITS NESTLE

S.A 1800 Vevey, Switzerland

(111) No. 24808

(180) 25/03/2032

(540) Renewal

SUNRISE

(511) 30

(210) No. 25341

(220) 06/12/2011

(732) SOCIETE DES PRODUITS NESTLE

S.A 1800 Vevey, Switzerland

(111) No. 24812

(180) 25/03/2032

(540) Renewal

TASTER'S CHOICE

(511) 30

(210) No. 25343

(220) 06/12/2011

(732) SOCIETE DES PRODUITS NESTLE

S.A 1800 Vevey, Switzerland

(111) No. 24814

(180) 25/03/2032

(540) Renewal

The logo for BIT consists of the letters 'BIT' in a large, bold, serif font.

(511) 34

(210) No. 25627

(220) 06/01/2012

(732) KT & G CORPORATION

100, Pyongchon-dong, Taedeok-ku, Taejeon,
Republic Of Korea.

(111) No. 24964

(180) 06/01/2032

(540) Renewal



(511) 30

(210) No. 25639

(220) 12/01/2012

(732) Babas Nadi (M) Sdn Bhd Block C, Lot

46911, Taman Perindustrian Selayang, 68100
Batu Caves, Selangor Darul Ehsan, Malaysia

(111) No. 24974

(180) 12/01/2032

(540) Renewal

MAINFREIGHT

(511) 39

(210) No. 25706

(220) 27/01/2012

(732) MAINFREIGHT LIMITED

2 Railway Lane, Otahuhu, Auckland 1062,
New Zealand

(111) No. 25029

(180) 27/01/2032

(540) Renewal

 **SAILUN**

(511) 12

(210) No. 25798

(220) 22/02/2012

(732) SAILUN GROUP CO., LTD.

No.588, Maoshan Road, Huangdao District,
Qingdao City, Shandong, China.

(111) No. 25123

(180) 22/02/2032

(540) Renewal

Oriental Leaf

(511) 34

(210) No. 25892

(220) 13/03/2012

(732) China Tobacco Hunan Industrial Co. Ltd.

No. 188, Section 3, Wanjiali Zhong Road,

Yuhua District, Changsha City, Hunan, China

(111) No. 25208

(180) 13/03/2032

(540) Renewal

MOVING RUBBER

(511) 03

(210) No. 26065

(220) 27/03/2012

(732) Mandom Corp.

5-12, Juniken-cho, Chuo-ku, Osaka, Japan

(111) No. 25297

(180) 27/03/2032

(540) Renewal

**GATSBY MOVING
RUBBER**

(511) 03

(210) No. 26066

(220) 27/03/2012

(732) Mandom Corp.

5-12, Juniken-cho, Chuo-ku, Osaka, Japan

(111) No. 25298

(180) 27/03/2032

(540) Renewal

mojito

(511) 34

(210) No. 26109

(220) 28/03/2012

(732) KT & G CORPORATION

100, Pyongchon-dong, Taedeok-ku, Taejeon,

Republic Of Korea.

(111) No. 25335

(180) 28/03/2032

(540) Renewal

FAÇADE

(511) 34

(210) No. 26110

(220) 28/03/2012

(732) KT & G CORPORATION

100, Pyongchon-dong, Taedeok-ku, Taejeon,
Republic Of Korea.

(111) No. 25336

(180) 28/03/2032

(540) Renewal

FACADE

(511) 34

(210) No. 26111

(220) 28/03/2012

(732) KT & G CORPORATION

100, Pyongchon-dong, Taedeok-ku, Taejeon
Republic Of Korea.

(111) No. 25337

(180) 28/03/2032

(540) Renewal

Calvin Klein

(511) 03

(210) No. 26160

(220) 04/04/2012

(732) CALVIN KLEIN TRADEMARK TRUST

(c/o Wilmington Trust Company, Trustee),

Rodney Square North, 1100 North Market

Street, Wilmington, Delaware 19890, United

States Of America

(111) No. 25569

(180) 20/01/2032

ພາກທີ III
(Part III)

ເຄື່ອງໝາຍການຄ້າ
Trademarks

4. ການປ່ຽນແປງ
(Changes)

ພາກທີ III
(Part III)
ເຄື່ອງໝາຍການຄ້າ
Trademarks

5. ການດັດແກ້
(Amendments)

ພາກທີ IV
(Part IV)

ເຄື່ອງໝາຍການຄ້າຜ່ານລະບົບມາດຣິດ
Trademarks via Madrid Protocol

1. ຄໍາຮ້ອງ
(Applications)

ຄໍາອະທິບາຍກ່ຽວກັບລະຫັດຫຍໍ້
(Introduction of Codes)

- (540) ເຄື່ອງໝາຍການຄ້າ (Trademark)
- (511) ໝວດ (Nice Classification)
- (210) ເລກທີ ຄໍາຮ້ອງ (Number of the application)
- (220) ວັນທີ ຄໍາຮ້ອງ (Date of filing of the application)
- (732) ຊື່ ແລະ ທີ່ຢູ່ ຂອງຜູ້ຍື່ນຄໍາຮ້ອງ (Name and Address of applicant)

ພາກທີ IV

(Part IV)

ເຄື່ອງໝາຍການຄ້າຜ່ານລະບົບມາດຣິດ

Trademarks via Madrid Protocol

2. ຜົນການຈົດທະບຽນ

(Registration)

ຄຳອະທິບາຍກ່ຽວກັບລະຫັດຫຍໍ້

(Introduction of Codes)

- (540) ເຄື່ອງໝາຍການຄ້າ (Trademark)
- (511) ໝວດ (Nice Classification)
- (210) ເລກທີ ຄຳຮ້ອງ (Number of the application)
- (220) ວັນທີ ຍື່ນຄຳຮ້ອງ (Date of filing of the application)
- (732) ຊື່ ແລະ ທີ່ຢູ່ ຂອງຜູ້ຍື່ນຄຳຮ້ອງ (Name and Address of applicant)
- (111) ເລກທີການຈົດທະບຽນເຄື່ອງໝາຍການຄ້າ (Number of the registration)
- (180) ວັນໝົດອາຍຸຂອງການຈົດທະບຽນ (Expiration date of the registration)

(540)

Olympus Glory

(511) 09 and 28

(210) No. M/1336571

(220) 21/03/2019

(732) Euro Games Technology Ltd.

"Maritsa" Str. 4, "Vranya-Lozen-Triugulnika"

BG-1151 Sofia, Bulgaria.

(111) No. M/1336571

(180) 14/09/2026

(540)

SCHNEIDER

(511) 07, 08, 09, 11, 14 and 21

(210) No. M/1409559

(220) 12/06/2019

(732) SCHNEIDER CONSUMER

IP 12 rue Jules Ferry F-93110 ROSNY-

SOUS-BOIS, France.

(111) No. M/1409559

(180) 23/01/2028

(540)

Mi Gaming Box

(511) 09, 38 and 41

(210) No. M/1464409

(220) 03/10/2018

(732) Xiaomi Inc.

Floor 13, Rainbow City Shopping Mall II of
China Resources, No. 68 Qinghe Middle
Street, Haidian District Beijing, China.

(111) No. M/1464409

(180) 03/10/2028

(540)

Danish Crown

(511) 01, 05, 29, 30, 31, 32, 33, 39, 40, 43 and 44

(210) No. M/1466054

(220) 10/01/2019

(732) Danish Crown

A/S Marsvej 43 DK-8960 Randers SØ,
Denmark.

(111) No. M/1466054

(180) 10/01/2029

(540)

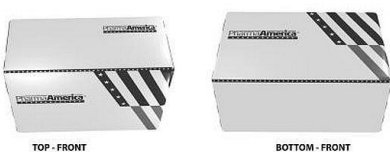
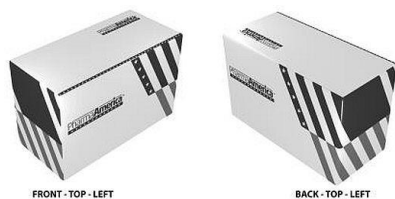

(511) 05

(210) No. M/1467423

(220) 17/11/2018

(732) PACIFIC PHARMACEUTICALS PTE LTD

and Pacific Pharmaceuticals USA, Inc.

101 Cecil Street, #17-07 Tong Eng Building

Singapore 069533, Singapore and 11380 7th

Street Rancho Cucamonga CA 91737, United

States Of America.

(111) No. M/1467423

(180) 17/11/2028

(540)

AI Fabric

(511) 09 and 42

(210) No. M/1480952

(220) 09/07/2019

(732) HUAWEI TECHNOLOGIES CO., LTD.

ADMINISTRATION BUILDING HUAWEI

TECHNOLOGIES CO., LTD.,

BANTIAN, LONGGANG DISTRICT,

SHENZHEN CITY GUANGDONG

PROVINCE, CHINA.

(111) No. M/1480952

(180) 09/07/2029

(540)



(511) 06, 11, 20, 29, 31 and 35

(210) No. M/1500866

(220) 06/05/2019

(732) CONG TY CO PHAN TAP DOAN HOA
PHAT (HOA PHAT GROUP JOINT STOCK
COMPANY)

Pho Noi A Industrial Zone, Giai Pham
Commune, Yen My District Hung Yen
Province, Vietnam.

(111) No. M/1500866

(180) 06/05/2029

(540)



(511) 01, 16, 17 and 19

(210) No. M/1181026

(220) 19/06/2020

(732) BOSTIK

SA 420 rue d'Estienne d'Orves F-92700
Colombes, France.

(111) No. M/1181026

(180) 22/07/2023

(540)

CHINA SOUTHERN

(511) 39

(210) No. M/1349711

(220) 01/04/2020

(732) CHINA SOUTHERN AIR HOLDING
COMPANY

Baiyun Airport, Guangzhou Guangdong
Province, China

(111) No. M/1349711

(180) 10/04/2027

(540)

渝新欧

(511) 03, 21, 29, 30, 31, 32, 33, 43 and 45

(210) No. M/1517690

(220) 12/12/2019

(732) YUXINOU (CHONGQING) SUPPLY
CHAIN MANAGEMENT CO.,

604, No. 1-39, Western Logistics Center,
Chongqing Road Transportation (Group) Co.,
Ltd, Western Modern Logistics Park,
Shapingba District, Chongqing, China

(111) No. M/1517690

(180) 12/12/2029

(540)

TAIHO

(511) 05

(210) No. M/1519330

(220) 17/12/2019

(732) TAIHO PHARMACEUTICAL CO., LTD.

1-27 Kandanshiki-cho, Chiyoda-ku Tokyo

101-8444, Japan

(111) No. M/1519330

(180) 17/12/2029

(540)



(511) 30

(210) No. M/1522013

(220) 17/12/2019

(732) JACOBS DOUWE EGBERTS RTL SCC SG

PTE. LTD.

30 Tuas Link 2, JDE Building 638568,

Singapore

(111) No. M/1522013

(180) 17/12/2029

(540)

ISUZU
D-MAX

(511) 12

(210) No. M/1529848

(220) 12/03/2020

(732) ISUZU MOTORS LIMITED

6-26-1 Minami-Oi, Shinagawa-ku Tokyo

140-8722, Japan

(111) No. M/1529848

(180) 12/03/2030

(540)



(511) 21, 30, 32 and 43

(210) No. M/1539102

(220) 19/03/2020

(732) BEIJING XIAOGUAN TEA CO., LTD.

Room C3-05, Shumiyuan, No. 10 Jiachuang

Road, Zhongguancun Science Park Opto-

Mechatronics Industrial Park, Tongzhou

District Beijing, China

(111) No. M/1539102

(180) 19/03/2030

(540)



(511) 09, 16, 35, 36, 39 and 42

(210) No. M/1540709

(220) 27/04/2020

(732) SF (IP) LIMITED

12/F, San Toi Building, 137-139 Connaught
Road Central Hong Kong, China

(111) No. M/1540709

(180) 27/04/2030

(540)

Openfit

(511) 09

(210) No. M/1563941

(220) 09/09/2020

(732) SHOKZ HOLDING LIMITED

RM 2603A 26/F TOWER 1 LIPPO CTR 89,
QUEENSWAY ADMIRALTY Hong Kong,
China

(111) No. M/1563941

(180) 09/09/2030

(540)



(511) 09, 16, 35, 36, 39 and 42

(210) No. M/1568457

(220) 21/10/2020

(732) SF (IP) LIMITED

12/F, San Toi Building, 137-139 Connaught
Road Central Hong Kong, China

(111) No. M/1568457

(180) 21/10/2030

(540)

ALIVE WITH THE SEASONS OF JAPAN

(511) 33

(210) No. M/1575366

(220) 28/10/2020

(732) Suntory Holdings Limited

1-40, Dojimahama 2-chome, Kita-ku, Osaka-
shi Osaka 530-8203, Japan

(111) No. M/1575366

(180) 28/10/2030

(540)

EVERGREEN

(511) 12

(210) No. M/0915853

(220) 25/11/2020

(732) QINGDAO COSMIC EVERGREEN TIRE
CO., LTD

Room 1306, No.182-6 Haier Road, Laoshan,
Qingdao Shandong, China

(111) No. M/0915853

(180) 06/02/2027

(540)

AP VENTURES

(511) 36

(210) No. M/1424164

(220) 21/01/2021

(732) AP VENTURES

LLP 45 Old Bond Street London W1S 4QT,
United Kingdom.

(111) No. M/1424164

(180) 09/07/2028

(540)



(511) 32

(210) No. M/1515200

(220) 10/12/2020

(732) CONG TY CO PHAN CHE BIEN THUC
PHAM VA NUOC GIAI KHAT VIET-MY
So 55, ngo 670, duong Ha Huy Tap, xa Dinh
Xuyen, huyen Gia Lam Ha Noi, Vietnam.

(111) No. M/1515200

(180) 26/11/2029

(540)

**ADDICTED TO
AUDIO**

(511) 35

(210) No. M/1549243

(220) 27/01/2021

(732) Dina Poutakidis
Se4, 792-796 High St KEW EAST VIC 3102,
Australia.

(111) No. M/1549243

(180) 16/07/2030

(540)

Zero Packaging

(511) 09, 35, 36, 38 and 39

(210) No. M/1576125

(220) 09/12/2020

(732) Coupang Corp.

18th Floor (Sincheon-dong), 570 Songpa-
daero, Songpa-gu Seoul, Republic Of Korea.

(111) No. M/1576125

(180) 09/12/2030

(540)

MAGSAFE DUO CHARGER

(511) 09

(210) No. M/1576342

(220) 19/01/2021

(732) Apple Inc.

One Apple Park Way Cupertino CA 95014,
United States Of America.

(111) No. M/1576342

(180) 19/01/2031

(540)



(511) 09

(210) No. M/1576397

(220) 18/01/2021

(732) Apple Inc.

One Apple Park Way Cupertino CA 95014,
United States Of America.

(111) No. M/1576397

(180) 18/01/2031

(540)



成安棉花

— Cheng An Cotton —

(511) 22

(210) No. M/1576479

(220) 13/01/2021

(732) Chengan County Cotton Association

Second floor, north of Fukang Road,
Cheng'an County, Handan City 056700
Hebei Province, China.

(111) No. M/1576479

(180) 13/01/2031

(540)

Coupang Zero Packaging

(511) 09, 35, 36, 38 and 39

(210) No. M/1576643

(220) 15/12/2020

(732) Coupang Corp.

18th Floor (Sincheon-dong), 570 Songpa-
daero, Songpa-gu Seoul, Republic Of Korea.

(111) No. M/1576643

(180) 15/12/2030

(540)



(511) 03, 08, 11 and 16

(210) No. M/1576709

(220) 09/12/2020

(732) SHENZHEN BORN PRETTY

TECHNOLOGY CO., LTD

1712-05, E Times Building, Heng Road,

No.159 North Pingji Avenue, Hehua

Community, Pinghu Street, Longgang

District, Shenzhen 518100 Guangdong,

China.

(111) No. M/1576709

(180) 09/12/2030

(540)

Coupang myStore

(511) 09, 35, 36, 38 and 39

(210) No. M/1577259

(220) 15/12/2020

(732) Coupang Corp.

18th Floor (Sincheon-dong), 570 Songpa-
daero, Songpa-gu Seoul, Republic Of Korea.

(111) No. M/1577259

(180) 15/12/2030

(540)

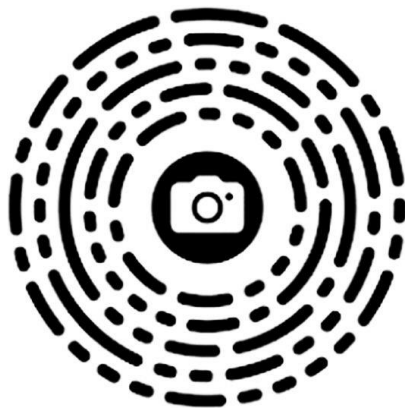

Apple App Clip

(511) 42

(210) No. M/1577800

(220) 18/01/2021

(732) Apple Inc.

One Apple Park Way Cupertino CA 95014,
United States Of America.

(111) No. M/1577800

(180) 18/01/2031

(540)



(511) 31

(210) No. M/1578016

(220) 19/10/2020

(732) Handan City Zhaofeng Agricultural
Technology Co. Ltd.

No.2, Buiding 19, North District of You Suo
Wei, Cheng an County, Handan City Hebei
Province, China.

(111) No. M/1578016

(180) 19/10/2030

(540)



(511) 28

(210) No. M/1578034

(220) 24/11/2020

(732) Mikasa Corporation

1, Kuchi, Asa-cho, Asakita-ku, Hiroshima-shi
Hiroshima-ken 731-3362, Japan.

(111) No. M/1578034

(180) 24/11/2030

(540)

Kzubr

(511) 07, 08 and 09

(210) No. M/1578204

(220) 02/12/2020

(732) XU RUOJUE

No.66, Xijin New Village, Jiangnan Street,
Yongkang City Zhejiang Province, China.

(111) No. M/1578204

(180) 02/12/2030

(540)



(511) 12

(210) No. M/1578330

(220) 07/12/2020

(732) YAMAHA HATSUDOKI KABUSHIKI

KAISHA

2500 Shingai, Iwata-shi Shizuoka-ken 438-
8501, Japan.

(111) No. M/1578330

(180) 07/12/2030

(540)

ROUTINE

(511) 25

(210) No. M/1578336

(220) 05/08/2020

(732) ROUTINE VIET NAM COMPANY
LIMITED

10th Floor, IMC Building, 62 Tran Quang

Khai, Tan Dinh ward, district 1 Ho Chi Minh
city, Vietnam.

(111) No. M/1578336

(180) 05/08/2030

(540)

쿠팡플레이

(511) 09, 35, 38, 41 and 42

(210) No. M/1578354

(220) 10/11/2020

(732) Coupang Corp.

18th Floor (Sincheon-dong), 570 Songpa-

daero, Songpa-gu Seoul, Republic Of Korea.

(111) No. M/1578354

(180) 10/11/2030

(540)

BENELLI TRK

(511) 12 and 35

(210) No. M/1578371

(220) 30/11/2020

(732) BENELLI Q.J. SRL

Strada Fornace Vecchia, s.n. I-61122

PESARO, Italy.

(111) No. M/1578371

(180) 30/11/2030

(540)

Coupang Play

(511) 09, 35, 38, 41 and 42

(210) No. M/1578387

(220) 10/11/2020

(732) Coupang Corp.

18th Floor (Sincheon-dong), 570 Songpa-

daero, Songpa-gu Seoul, Republic Of Korea.

(111) No. M/1578387

(180) 10/11/2030

(540)



(511) 09, 28 and 41

(210) No. M/1578405

(220) 20/11/2020

(732) Euro Games Technology Ltd.

4, "Maritsa" Str., "Vranya-Lozen-

Triugulnika" BG-1151 Sofia, Bulgaria.

(111) No. M/1578405

(180) 20/11/2030

(540)

水灵子

(511) 11

(210) No. M/1578413

(220) 09/12/2020

(732) Li Yangui

No.682, Qiaozhuang Village, Zhigou Town,

Zhucheng City, Weifang Shandong Province,

China.

(111) No. M/1578413

(180) 09/12/2030

(540)



(511) 12 and 37

(210) No. M/1578414

(220) 03/12/2020

(732) Yibin Kaiyi Automobile Co., Ltd.

328 Room, Enterprise Service Center, No. 17,
Lingang Avenue, Lingang Economic and
Technology Development Zone, Yibin City
644000 Sichuan Province, China.

(111) No. M/1578414

(180) 03/12/2030

(540)

SABINETEK

(511) 09

(210) No. M/1578508

(220) 18/12/2020

(732) Beijing Sabine Technologies Co., Ltd.

12A-3B, 12F, Building B, Jia No. 28, Xinxi
Road, Haidian District Beijing, China.

(111) No. M/1578508

(180) 18/12/2030

(540)



Movement that inspires

(511) 37

(210) No. M/1578582

(220) 16/01/2021

(732) Kia Corporation

12, Heolleung-ro, Seocho-gu Seoul 06797,

Republic Of Korea.

(111) No. M/1578582

(180) 16/01/2031

(540)



Movement that inspires

(511) 12

(210) No. M/1578583

(220) 16/01/2021

(732) Kia Corporation

12, Heolleung-ro, Seocho-gu Seoul 06797,

Republic Of Korea.

(111) No. M/1578583

(180) 16/01/2031

(540)

Rocket Same-Day Delivery

(511) 09, 35, 36, 38 and 39

(210) No. M/1578584

(220) 09/12/2020

(732) Coupang Corp.

18th Floor (Sincheon-dong), 570 Songpa-
daero, Songpa-gu Seoul, Republic Of Korea.

(111) No. M/1578584

(180) 09/12/2030

(540)



Movement that inspires

(511) 35

(210) No. M/1578604

(220) 16/01/2021

(732) Kia Corporation

12, Heolleung-ro, Seocho-gu Seoul 06797,
Republic Of Korea.

(111) No. M/1578604

(180) 16/01/2031

(540)

Snap Returns

(511) 09, 35, 36, 38 and 39

(210) No. M/1578609

(220) 09/12/2020

(732) Coupang Corp.

18th Floor (Sincheon-dong), 570 Songpa-
daero, Songpa-gu Seoul, Republic Of Korea.

(111) No. M/1578609

(180) 09/12/2030

(540)



(511) 09 and 42

(210) No. M/1578795

(220) 18/01/2021

(732) Apple Inc.

One Apple Park Way Cupertino CA 95014,
United States Of America.

(111) No. M/1578795

(180) 18/01/2031

(540)

EPSON

(511) 02, 07, 09, 16 and 36

(210) No. M/1578806

(220) 27/11/2020

(732) Seiko Epson Kabushiki Kaisha (also trading as

Seiko Epson Corporation)

1-6, Shinjuku 4-chome, Shinjuku-ku Tokyo

160-8801, Japan.

(111) No. M/1578806

(180) 27/11/2030

(540)

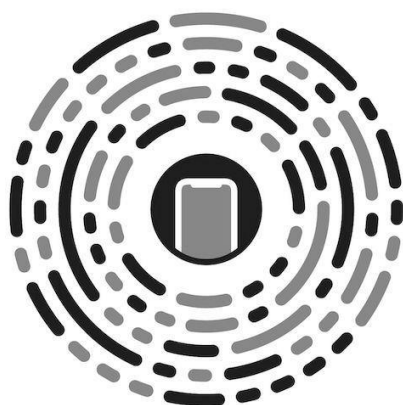

Apple App Clip

(511) 09 and 42

(210) No. M/1578988

(220) 18/01/2021

(732) Apple Inc.

One Apple Park Way Cupertino CA 95014,

United States Of America.

(111) No. M/1578988

(180) 18/01/2031

(540)

嫦娥



(511) 34

(210) No. M/1578991

(220) 06/10/2020

(732) LA FLOR PTE. LTD.

1 Tampines North Drive 1, #8-20 T-SPACE
528559, Singapore.

(111) No. M/1578991

(180) 06/10/2030

(540)



(511) 02, 03, 04, 07, 08, 09, 11, 12, 14, 16, 18, 21,
25, 27, 28, 34, 35, 36, 37, 38, 39, 40, 41, 42 and 43

(210) No. M/1579102

(220) 27/08/2020

(732) Bayerische Motoren Werke

Aktiengesellschaft Petuelring 130 80809
München, Germany.

(111) No. M/1579102

(180) 27/08/2030

(540)



(511) 02, 03, 04, 07, 08, 09, 11, 12, 14, 16, 18, 21,
25, 27, 28, 34, 35, 36, 37, 38, 39, 40, 41, 42 and 43

(210) No. M/1579103

(220) 08/09/2020

(732) Bayerische Motoren Werke

Aktiengesellschaft Petuelring 130 80809

München, Germany.

(111) No. M/1579103

(180) 08/09/2030

(540)

**HERMANN
GMEINER**

(511) 36, 41, 43 and 44

(210) No. M/1579114

(220) 06/11/2020

(732) SOS-Kinderdorf Staffler Straße

10a A-6021 Innsbruck, Austria.

(111) No. M/1579114

(180) 06/11/2030

(540)



(511) 01, 02, 04, 05, 06, 09, 12, 16, 17, 19, 20, 21,
31, 35, 37, 39, 41, 42 and 45

(210) No. M/1579286

(220) 31/08/2020

(732) Idemitsu Kosan Co., Ltd.

2-1, Otemachi 1-chome, Chiyoda-ku Tokyo
100-8321, Japan.

(111) No. M/1579286

(180) 31/08/2030

(540)

HERBONIS

(511) 05 and 31

(210) No. M/1579344

(220) 08/01/2021

(732) Herbonis

AG Rheinstrasse 30 CH-4302 Augst,
Switzerland.

(111) No. M/1579344

(180) 08/01/2031

(540)



(511) 35, 38, 41 and 42

(210) No. M/1579486

(220) 06/10/2020

(732) RÁDIO E TELEVISÃO RECORD

S/A Rua da Várzea, 240 - Barra Funda

01140-080 São Paulo, Brazil.

(111) No. M/1579486

(180) 06/10/2030

(540)

BELL Link

(511) 09, 28 and 41

(210) No. M/1579689

(220) 20/11/2020

(732) Euro Games Technology Ltd.

4, "Maritsa" Str., "Vranya-Lozen-Triugulnika"

BG-1151 Sofia, Bulgaria.

(111) No. M/1579689

(180) 20/11/2030

(540)

eMeetRoom

(511) 42

(210) No. M/1579703

(220) 16/12/2020

(732) Shenzhen eMeet Technology Co., Ltd.

Unit 2C, Building A6, Guangming Science
Park, China Merchants, Guanguang Road
3009, Fenghuang Street, Guangming District,
Shenzhen Guangdong, China.

(111) No. M/1579703

(180) 16/12/2030

(540)

VIVU

(511) 38, 39 and 43

(210) No. M/1579749

(220) 19/03/2020

(732) TMG EUROPE HOLDINGS

SARL RUE JEAN-PIERRE BRASSEUR 1 L-
1258 LUXEMBRUGO, Luxembourg.

(111) No. M/1579749

(180) 19/03/2030

(540)



(511) 03

(210) No. M/1579816

(220) 09/12/2020

(732) Galderma Holding

SA Avenue d'Ouchy 4 CH-1006 Lausanne,
Switzerland.

(111) No. M/1579816

(180) 09/12/2030

(540)

尖叫

(511) 32

(210) No. M/1580157

(220) 18/11/2020

(732) NONGFU SPRING CO., LTD.

No. 181, Geyazhuang, Xihu District,
Hangzhou Zhejiang, China.

(111) No. M/1580157

(180) 18/11/2030

(540)

The logo for RISEN, featuring the word "RISEN" in a bold, italicized, sans-serif font with a horizontal line underneath.

(511) 12

(210) No. M/1580166

(220) 02/12/2020

(732) ZHONGCE RUBBER GROUP COMPANY
LIMITED

No.2 10th Avenue, Economic and
Technological Development Zone, Jianggan
District, Hangzhou Zhejiang, China.

(111) No. M/1580166

(180) 02/12/2030

(540)

Rocket Dawn Delivery

(511) 09, 35, 36, 38 and 39

(210) No. M/1580326

(220) 09/12/2020

(732) Coupang Corp.

18th Floor (Sincheon-dong), 570 Songpa-
daero, Songpa-gu Seoul, Republic Of Korea.

(111) No. M/1580326

(180) 09/12/2030

(540)

SPORTFIVE

(511) 09, 35, 36, 37, 38, 39, 41, 42, 43 and 45

(210) No. M/1580458

(220) 23/10/2020

(732) SPORTFIVE Global Holding

GmbH Barcastraße 5 22087 Hamburg,
Germany.

(111) No. M/1580458

(180) 23/10/2030

(540)



(511) 28

(210) No. M/1580617

(220) 18/11/2020

(732) DICKIE-SPIELZEUG GmbH & Co.

KG Werkstraße 1 90765 Fürth, Germany.

(111) No. M/1580617

(180) 18/11/2030

(540)



(511) 43

(210) No. M/1580675

(220) 04/11/2020

(732) DASH ENTERTAINMENT RESTAURANT
SERVICES COMPANY LIMITED

152 Nguyen Cong Tru, Nguyen Thai Binh
Ward, District 1 Ho Chi Minh City, Vietnam.

(111) No. M/1580675

(180) 04/11/2030

(540)

KID POWER

(511) 29

(210) No. M/1580802

(220) 30/11/2020

(732) CONG TY TNHH XNK & TM PHUONG
LINH

No. 33, Nguyen Nhu Do, Van Mieu Ward,
Dong Da District Hanoi City, Vietnam.

(111) No. M/1580802

(180) 30/11/2030

(540)

dadi

(511) 41

(210) No. M/1581001

(220) 07/12/2020

(732) ZHUHAI MEIDI EDUCATION

TECHNOLOGY COMPANY LIMITED

Room 202, 295 Yingyan North Road, Pingsha

Town, Zhuhai City 519000 Guangdong

Province, China.

(111) No. M/1581001

(180) 07/12/2030

(540)

SWATCH BIG BOLD

(511) 14

(210) No. M/1581008

(220) 10/12/2020

(732) Swatch AG (Swatch SA) (Swatch Ltd.)

Nicolas G. Hayek Strasse 1 CH-2502

Biel/Bienne, Switzerland.

(111) No. M/1581008

(180) 10/12/2030

(540)



(511) 09, 35, 38, 41 and 42

(210) No. M/1581086

(220) 10/11/2020

(732) Coupang Corp.

18th Floor (Sincheon-dong), 570 Songpa-
daero, Songpa-gu Seoul, Republic Of Korea.

(111) No. M/1581086

(180) 10/11/2030

(540)

The logo for Idemitsu, consisting of the word "idemitsu" in a lowercase, bold, sans-serif font.

(511) 01, 02, 04, 05, 06, 09, 12, 16, 17, 19, 20, 21,
31, 35, 37, 39, 41, 42 and 45

(210) No. M/1581248

(220) 31/08/2020

(732) Idemitsu Kosan Co., Ltd.

2-1, Otemachi 1-chome, Chiyoda-ku Tokyo
100-8321, Japan.

(111) No. M/1581248

(180) 31/08/2030

(540)

FRESTINE

(511) 05, 29, 35 and 40

(210) No. M/1581408

(220) 14/12/2020

(732) Frestine Dairy Australia Pty Limited

KPMG Tower 3, Level 38, 300 Barangaroo

Avenue Sydney NSW 2000, Australia.

(111) No. M/1581408

(180) 14/12/2030

(540)



(511) 41

(210) No. M/1581488

(220) 27/11/2020

(732) XCL Education Holdings Pte. Ltd.

83 CLEMENCEAU AVENUE, #11-01 UE

SQUARE SINGAPORE 239920, Singapore.

(111) No. M/1581488

(180) 27/11/2030

(540)



(511) 09, 12, 14, 16, 17, 18, 25, 28, 35, 37, 41 and
42

(210) No. M/1582031

(220) 02/12/2020

(732) PIRELLI & C. S.p.A.

Viale Piero e Alberto Pirelli 25 I-20126

Milano, Italy.

(111) No. M/1582031

(180) 02/12/2030

(540)



(511) 32

(210) No. M/1582040

(220) 04/12/2020

(732) SAI GON - KIEN GIANG BEER JOINT
STOCK COMPANY

Road D1, D2, Thanh Loc Industrial Park,

Thanh Loc Commune, Chau Thanh District

Kien Giang Province, Vietnam.

(111) No. M/1582040

(180) 04/12/2030

(540)

The logo consists of the words "RED HD" in a smaller, bold, red font with a white outline, positioned above the word "POWER" in a larger, bold, red font with a white outline and a slight shadow effect.

(511) 09, 28 and 41

(210) No. M/1582170

(220) 20/11/2020

(732) Euro Games Technology Ltd.

"Maritsa" Str., 4, „Vranya-Lozen-

Triugulnika" BG-1151 Sofia, Bulgaria.

(111) No. M/1582170

(180) 20/11/2030

(540)

The logo consists of the words "APPLE ONE" in a bold, black, sans-serif font.

(511) 35 and 42

(210) No. M/1582239

(220) 22/10/2020

(732) Apple Inc.

One Apple Park Way Cupertino CA 95014,

United States Of America.

(111) No. M/1582239

(180) 22/10/2030

(540)

Coupang MyShop

(511) 09, 35, 36, 38 and 39

(210) No. M/1582400

(220) 29/12/2020

(732) Coupang Corp.

18th Floor (Sincheon-dong), 570 Songpa-
daero, Songpa-gu Seoul, Republic Of Korea.

(111) No. M/1582400

(180) 29/12/2030

(540)

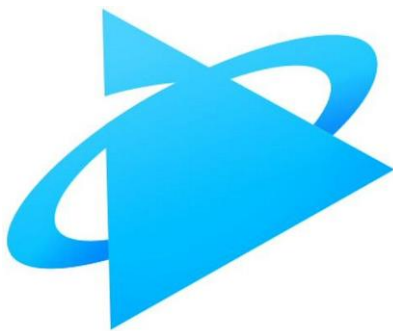

(511) 09, 35, 38, 41 and 42

(210) No. M/1582554

(220) 29/12/2020

(732) Coupang Corp.

18th Floor (Sincheon-dong), 570 Songpa-
daero, Songpa-gu Seoul, Republic Of Korea.

(111) No. M/1582554

(180) 29/12/2030

(540)



(511) 09, 35, 36, 38, 41, 42 and 45

(210) No. M/1582626

(220) 29/10/2020

(732) Wuhan Douyu Network Technology Co.,Ltd
Room 01, Floor 12-19, Building B3, Zone B,
Software Industry 4.1, 1 East Software Park
Road, Donghu New Technology
Development Zone, Wuhan city 430014
Hubei, China.

(111) No. M/1582626

(180) 29/10/2030

(540)



(511) 09, 35 and 41

(210) No. M/1582640

(220) 09/10/2020

(732) National Basketball Players Association
1133 Avenue of the Americas, 5th Floor New
York NY 10036, United States Of America.

(111) No. M/1582640

(180) 09/10/2030

(540)

LILAIYA

(511) 03

(210) No. M/1582744

(220) 02/09/2020

(732) ZHENG ZHIHUA

Room 1305, Ladder 3, South 9th Huiqiao

New Town, Baiyun District, Guangzhou City

510000 Guangdong Province, China.

(111) No. M/1582744

(180) 02/09/2030

(540)

A. MIARAY

(511) 03, 08, 21, 41 and 44

(210) No. M/1583004

(220) 10/12/2020

(732) Pias Corporation

19-3, Toyosaki 3-chome, Kita-ku, Osaka-shi

Osaka 531-0072, Japan.

(111) No. M/1583004

(180) 10/12/2030

(540)

COVI-VAC

(511) 05

(210) No. M/1583031

(220) 20/11/2020

(732) SERUM INSTITUTE OF INDIA PRIVATE
LIMITED

Sarosh Bhavan, 16-B/1, Dr. Ambedkar Road
Pune-411001, Maharashtra, India.

(111) No. M/1583031

(180) 20/11/2030

(540)

ARTEMIS

(511) 09, 12, 35, 37 and 39

(210) No. M/1583035

(220) 01/12/2020

(732) Volkswagen Aktiengesellschaft Berliner Ring
2 38440 Wolfsburg, Germany.

(111) No. M/1583035

(180) 01/12/2030

(540)

Tenz

(511) 30, 32 and 43

(210) No. M/1583053

(220) 07/12/2020

(732) Tenz GmbH Hohlstrasse

44 CH-8004 Zürich, Switzerland.

(111) No. M/1583053

(180) 07/12/2030

(540)

COVOVAX

(511) 05

(210) No. M/1583076

(220) 20/11/2020

(732) SERUM INSTITUTE OF INDIA PRIVATE
LIMITED

Sarosh Bhavan, 16-B/1, Dr. Ambedkar Road

Pune-411001, Maharashtra, India.

(111) No. M/1583076

(180) 20/11/2030

(540)

COVI SHIELD

(511) 05

(210) No. M/1583082

(220) 20/11/2020

(732) SERUM INSTITUTE OF INDIA PRIVATE
LIMITED

Sarosh Bhavan, 16-B/1, Dr. Ambedkar Road
Pune-411001, Maharashtra, India.

(111) No. M/1583082

(180) 20/11/2030

(540)



(511) 25

(210) No. M/1583201

(220) 12/02/2021

(732) HOLISTIC HEALTH, INC.

9070 GLEANNLOCH FOREST DRIVE,
SUITE 100 SPRING TX 77379, United
States Of America.

(111) No. M/1583201

(180) 12/02/2031

ພາກທີ IV
(Part IV)

ເຄື່ອງໝາຍການຄ້າຜ່ານລະບົບມາດຣິດ
Trademarks via Madrid Protocol

3. ຜົນການຕໍ່ອາຍຸ
(Renewal)

ຄຳອະທິບາຍກ່ຽວກັບລະຫັດຫຍໍ້
(Introduction of Codes)

- (540) ເຄື່ອງໝາຍການຄ້າ (Trademark)
- (511) ໝວດ (Nice Classification)
- (210) ເລກທີ ຄຳຮ້ອງ (Number of the application)
- (220) ວັນທີ ຍື່ນຄຳຮ້ອງ (Date of filing of the application)
- (732) ຊື່ ແລະ ທີ່ຢູ່ ຂອງຜູ້ຍື່ນຄຳຮ້ອງ (Name and Address of applicant)
- (111) ເລກທີການຈົດທະບຽນເຄື່ອງໝາຍການຄ້າ (Number of the registration)
- (180) ການຕໍ່ອາຍຸຂອງການຈົດທະບຽນ (Expiration date of the renewal)

ພາກທີ IV

(Part IV)

ເຄື່ອງໝາຍການຄ້າຜ່ານລະບົບມາດຣິດ

Trademarks via Madrid Protocol

4. ການປ່ຽນແປງ

(Changes)

ພາກທີ IV

(Part IV)

ເຄື່ອງໝາຍການຄ້າຜ່ານລະບົບມາດຣິດ

Trademarks via Madrid Protocol

5. ການດັດແກ້

(Amendments)

ພາກທີ V
(Part V)
ຖິ່ນກຳເນີດ
Geographical Indications

1. ຄຳຮ້ອງ
(Applications)

ພາກທີ V
(Part V)
ຖິ່ນກຳເນີດ
Geographical Indications

2. ຜົນການຈົດທະບຽນ
(Registration)

ພາກທີ V

(Part V)

ຖິ່ນກຳເນີດ

Geographical Indications

3. ການປ່ຽນແປງ

(Changes)

ພາກທີ V
(Part V)
ຖິ່ນກຳເນີດ
Geographical Indications

4. ການດັດແກ້
(Amendments)

ພາກທີ VI

(Part VI)

ພັນພືດໃໝ່

New Plant Varieties

1. ຄໍາຮ້ອງ

(Applications)

ພາກທີ VI

(Part VI)

ພັນພືດໃໝ່

New Plant Varieties

2. ຜົນການຈັດທະບຽນ

(Registration)

ພາກທີ VI

(Part VI)

ພັນພືດໃໝ່

New Plant Varieties

3. ການປ່ຽນແປງ

(Changes)

ພາກທີ VI

(Part VI)

ພັນພືດໃໝ່

New Plant Varieties

4. ການດັດແກ້

(Amendments)

ພາກທີ VII

(Part VII)

ລິຂະສິດ ແລະ ສິດກ່ຽວຂ້ອງກັບລິຂະສິດ

Copyrights and Related Rights

1. ການແຈ້ງຂໍ້ມູນ

(Notifications)

ພາກທີ VII

(Part VII)

ລິຂະສິດ ແລະ ສິດກ່ຽວຂ້ອງກັບລິຂະສິດ

Copyrights and Related Rights

2. ການປ່ຽນແປງ

(Changes)

ພາກທີ VIII

(Part VIII)

**ການແກ້ໄຂຂໍ້ຂັດແຍ່ງທາງດ້ານບໍລິຫານກ່ຽວກັບການຈົດທະບຽນຊັບ
ສິນອຸດສາຫະກຳ ແລະ ພັນພືດໃໝ່**

**Administrative Dispute Resolutions on the Registration of
Industrial Property and New Plant Varieties**

1. ຜົນການຄັດຄ້ານຄຳຮ້ອງ

(Result of Oppositions)

ພາກທີ VIII

(Part VIII)

**ການແກ້ໄຂຂໍ້ຂັດແຍ່ງທາງດ້ານບໍລິຫານກ່ຽວກັບການຈົດທະບຽນຊັບ
ສິນອຸດສາຫະກຳ ແລະ ພັນພືດໃໝ່**

**Administrative Dispute Resolutions on the Registration of
Industrial Property and New Plant Varieties**

2. ຜົນການແຈ້ງປະຕິເສດ

(Result of Refusals)

ພາກທີ VIII

(Part VIII)

ການແກ້ໄຂຂໍ້ຂັດແຍ່ງທາງດ້ານບໍລິຫານກ່ຽວກັບການຈົດທະບຽນຊັບ

ສິນອຸດສາຫະກຳ ແລະ ພັນພືດໃໝ່

**Administrative Dispute Resolutions on the Registration of
Industrial Property and New Plant Varieties**

3. ຜົນການຍົກເລີກ ຫຼື ລົບລ້າງ ຂອງການຈົດທະບຽນ

(Result of Cancellation or Invalidation of Registration)