



ສາທາລະນະລັດ ປະຊາທິປະໄຕ ປະຊາຊົນລາວ
LAO PEOPLE'S DEMOCRATIC REPUBLIC

ກະຊວງ ອຸດສາຫະກຳ ແລະ ການຄ້າ
ກົມຊັບສິນທາງປັນຍາ

MINISTRY OF INDUSTRY AND COMMERCE
DEPARTMENT OF INTELLECTUAL PROPERTY

ຈົດໝາຍເຫດທາງລັດຖະການ
ກ່ຽວກັບ ຊັບສິນທາງປັນຍາ
ຢູ່ ສປປ ລາວ

OFFICIAL GAZETTE ON INTELLECTUAL PROPERTY
IN LAO PDR

ສະບັບທີ (Vol.) 168

ພາກທີ I (Part I)

ສິດທິບັດ ແລະ ອະນຸສິດທິບັດ (Patent and Petty Patent)

1. ຄໍາຮ້ອງ (Applications)

ຄໍາອະທິບາຍກ່ຽວກັບລະຫັດຫຍໍ້ (Introduction of Codes)

- (21) ເລກທີ ຄໍາຮ້ອງ (Filing Number)
- (22) ວັນທີ ຍືນຄໍາຮ້ອງ (Filing Date)
- (30) ວັນທີ ບຸລິມະສິດ (Priority Date)
- (43) ວັນທີເຜີຍແຜ່ (Publication Date)
- (51) ໝວດ (International Patent Classification)
- (54) ຊື່ຂອງການປະດິດ (Title)
- (57) ບົດຄັດຫຍໍ້ (Abstract)
- (71) ຊື່ ແລະ ທີ່ຢູ່ ເຈົ້າຂອງສິດທິບັດ ແລະ ອະນຸສິດທິບັດ (Owner Name and Address)
- (72) ຊື່ຜູ້ປະດິດ (Inventor Name)
- (74) ຊື່ຕົວແທນ (Representative Name)
- (55) ຮູບພາບ (Pictures)

ພາກທີ I (Part I)

ສິດທິບັດ ແລະ ອະນຸສິດທິບັດ (Patent and Petty Patent)

2. ຜົນການອອກສິດທິບັດ ແລະ ອະນຸສິດທິບັດ (Grant of Patents and Petty Patents)

ຄຳອະທິບາຍກ່ຽວກັບລະຫັດຫຍໍ້ (Introduction of Codes)

- (11) ເລກທິ (Grant Number)
- (21) ເລກທິ ຄຳຮ້ອງ (Filing Number)
- (22) ວັນທີຍືນຄຳຮ້ອງ (Filing Date)
- (30) ວັນທີ ບຸລິມະສິດ (Priority Date)
- (43) ວັນທີເຜີຍແຜ່ (Publication Date)
- (51) ໝວດ (International Patent Classification)
- (54) ຫົວຂໍ້ການປະດິດ (Title)
- (57) ບົດຄັດຫຍໍ້ (Abstract)
- (71) ຊື່ ແລະ ທີ່ຢູ່ ເຈົ້າຂອງສິດທິບັດ ແລະ ອະນຸສິດທິບັດ (Owner Name and Address)
- (72) ຊື່ຜູ້ປະດິດ (Inventor Name)
- (74) ຊື່ຕົວແທນ (Representative Name)
- (55) ຮູບພາບ (Pictures)

- (11) No. 67
- (21) PP 67
- (22) 18/03/2020
- (30)
- (43)
- (51) Int.Cl. G 01F 23/02(2006.01), F 02M 25/12(2006.01)
- (54) A SYSTEM FOR GENERATING AND SUPPLYING HYDROGEN GAS TO AN INTERNAL COMBUSTION ENGINE
- (57) The present invention disclosed a system for generating and supplying hydrogen gas to an internal combustion engine. The system comprises at least one hydrogen generator unit configured to generate hydrogen gas from water received from a primary water tank connected to the hydrogen generating unit. The hydrogen generating unit is also connected to an electrical control unit of the hydrogen generator unit which controls supply of power from power supply unit for the electrolysis of water at the hydrogen generating unit. The hydrogen generating unit also connected to a car electrical control unit whereby through the operation of the electrical control unit of the hydrogen generating unit connected to the car electrical control unit it enables the system to control activation/deactivation of the hydrogen generating unit, the output rate of the hydrogen to be generated, the quantity of the hydrogen to be supplied to the engine system through a back fire prevention unit disposed between the primary water tank and the engine system.
- (71) Suebphong CHALITAPORN
126/2 Nanglinchi Soi 6, Nanglinchi Road, Thungmahamek, Sathorn, Bangkok 10120 Thailand.
- (72) Sittichot KRADANG-NGA.
- (74) LAO INTERCONSULT CO., LTD. (LICO).
- (55)

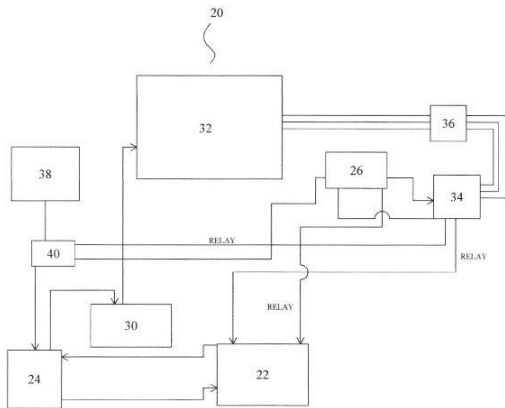

FIG.1

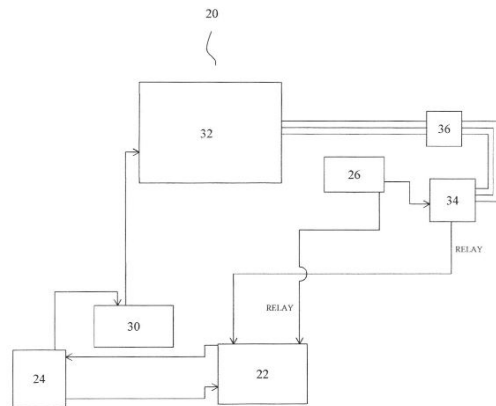

FIG.1A

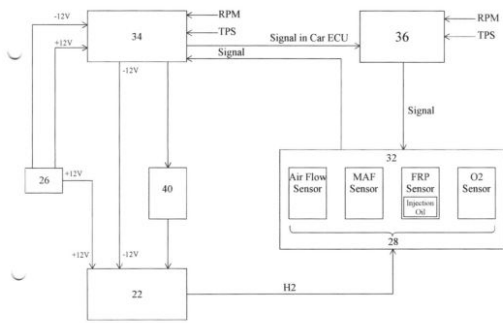

FIG.11

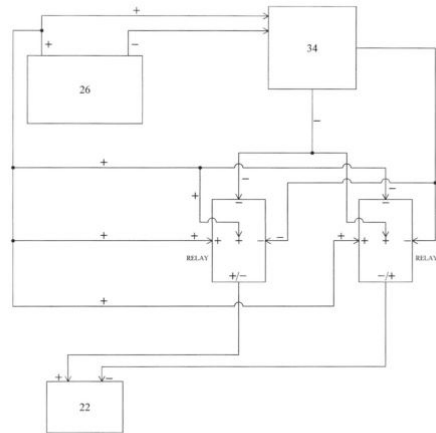

FIG.12

ພາກທີ I

(Part I)

ສິດທິບັດ ແລະ ອະນຸສິດທິບັດ

(Patent and Petty Patent)

3. ການປ່ຽນແປງ

(Changes)

ພາກທີ I

(Part I)

**ສິດທິບັດ ແລະ ອະນຸສິດທິບັດ
(Patent and Petty Patent)**

4. ການດັດແກ້

(Amendments)

ພາກທີ II
(Part II)
ແບບອຸດສາຫະກຳ
(Industrial Design)

1. ຄຳຮ້ອງ
(Applications)

ຄຳອະທິບາຍກ່ຽວກັບລະຫັດຫຍໍ້
(Introduction of Codes)

- (21) ເລກທີ ຄຳຮ້ອງ (Filing Number)
- (22) ວັນທີ ຄຳຮ້ອງ (Filing Date)
- (30) ວັນທີ ບຸລິມາສິດ (Priority Date)
- (51) ໝວດ (Locarno Classification)
- (54) ຊື່ຂອງແບບອຸດສາຫະກຳ (Title)
- (71) ຊື່ ແລະ ທີ່ຢູ່ ຂອງເຈົ້າຂອງ (Owner Name and Address)
- (72) ຊື່ຜູ້ອອກແບບ (Designer Name)
- (74) ຊື່ຕົວແທນ (Representative Name)
- (55) ຮູບພາບ (Pictures)

ພາກທີ II
(Part II)
ແບບອຸດສາຫະກຳ
(Industrial Design)

2. ຜົນການຈົດທະບຽນ
(Registration)

ຄຳອະທິບາຍກ່ຽວກັບລະຫັດຫຍໍ້
(Introduction of Codes)

- (11) ເລກທີ ຈົດທະບຽນ (Registration Number)
- (15) ວັນທີ ຈົດທະບຽນ (Registration Date)
- (21) ເລກທີ ຍືນຄຳຮ້ອງ (Filing Number)
- (22) ວັນທີ ຍືນຄຳຮ້ອງ (Filing Date)
- (30) ວັນທີ ບຸລິມາສິດ (Priority Date)
- (17) ວັນທີ ໝົດອາຍຸ (Expiration Date)
- (51) ໝວດ (Locarno Classification)
- (54) ຊື່ຂອງແບບອຸດສາຫະກຳ (Title)
- (71) ຊື່ ແລະ ທີ່ຢູ່ ຂອງເຈົ້າຂອງ (Owner Name and Address)
- (72) ຊື່ຜູ້ອອກແບບ (Designer Name)
- (74) ຊື່ຕົວແທນ (Representative Name)
- (55) ຮູບພາບ (Pictures)

ພາກທີ II

(Part II)

ແບບອຸດສາຫະກຳ

(Industrial Design)

3. ການປ່ຽນແປງ

(Changes)

ພາກທີ II

(Part II)

ແບບອຸດສາຫະກຳ

(Industrial Design)

4. ການດັດແກ້

(Amendments)

ພາກທີ III
(Part III)
ເຄື່ອງໝາຍການຄ້າ
Trademarks

1. ຄໍາຮ້ອງ
(Applications)

ຄໍາອະທິບາຍກ່ຽວກັບລະຫັດຫຍໍ້
(Introduction of Codes)

- (540) ເຄື່ອງໝາຍການຄ້າ (Trademark)
- (511) ໝວດ (Nice Classification)
- (210) ເລກທີ ຄໍາຮ້ອງ (Number of the application)
- (220) ວັນທີ ຄໍາຮ້ອງ (Date of filing of the application)
- (732) ຊື່ ແລະ ທີ່ຢູ່ ຂອງຜູ້ຍື່ນຄໍາຮ້ອງ (Name and Address of applicant)

(540)



(511) 30 and 31

(210) No. 46654

(220) 25/01/2022

(732) ບໍລິສັດ ນໍ້າເຕີຊານພັດທະນາກະສິກໍາ ຈໍາກັດ (ທ່ານ
ມາຍິງປິງ)

ບ້ານ ຈອມແຈ້ງ, ເມືອງລອງ, ແຂວງຫຼວງນໍ້າທາ,
ສປປ ລາວ.

(540)



(511) 14, 21 and 35

(210) No. 46659

(220) 27/01/2022

(732) ບໍລິສັດ ຝ່າວັດທະນາ ຂາອອກ-ຂາເຂົ້າ ວັດຖຸມີຄ່າ
ຈໍາກັດຜູ້ດຽວ

463 ຖະໜົນເຈົ້າອານຸ, ບ້ານທົ່ງຂັນຄໍາ,
ເມືອງຈັນທະບູລີ, ນະຄອນຫຼວງວຽງຈັນ, ສປປ ລາວ.

(540)

THAITA
ໄທຕ້າ

(511) 12

(210) No. 46935

(220) 26/04/2022

(732) ບໍລິສັດ ນໍາເຂົ້າ-ສົ່ງອອກ ໄທຕ້າ ຈຳກັດຜູ້ດຽວ

ບ້ານໜອງດ້ວງໃຕ້, ເມືອງສີໂຄດຕະບອງ, ສປປ ລາວ.

(540)

JUNIPER

(511) 09, 37, 41 and 42

(210) No. 46940

(220) 28/04/2022

(732) Juniper Networks, Inc.

1133 Innovation Way, Sunnyvale, California
94089, United States of America.

(540)



(511) 30

(210) No. 46946

(220) 03/05/2022

(732) ນາງ ທິບພະວັນ ອ່ອນມະນີ

ບ້ານ ວັດຫຼວງ, ເມືອງ ລະມາມ, ແຂວງ ເຊກອງ,
ສປປ ລາວ.

(540)



(511) 30 and 35

(210) No. 46947

(220) 03/05/2022

(732) ບໍລິສັດ ພວງແສງ ພັດທະນາກະສິກໍາ ນໍາເຂົ້າ ແລະ

ສິ່ງອອກ ຈໍາກັດຜູ້ດຽວ

ບ້ານນາສ້ຽວ, ເມືອງນາຊາຍທອງ, ສປປ ລາວ.

(540)

**AEON LAO MOBILE
APPLTICATION**

(511) 09, 35 and 36

(210) No. 46948

(220) 03/05/2022

(732) AEON KABUSHIKI KAISHA (also trading
as AEON Co., Ltd.)

1-5-1 Nakase, Mihama-Ku, Chiba-City,
Chiba 261-8515, Japan.

(540)



(511) 09, 35 and 36

(210) No. 46949

(220) 03/05/2022

(732) AEON KABUSHIKI KAISHA (also trading
as AEON Co., Ltd.)

1-5-1 Nakase, Mihama-Ku, Chiba-City,
Chiba 261-8515, Japan.

(540)

CapCut

(511) 09, 35, 38, 41, 42 and 45

(210) No. 46950

(220) 03/05/2022

(732) LEMON INC.

P.O. BOX 31119 GRAND PAVILION,
HIBISCUS WAY, 802 WEST BAY ROAD,
GRAND CAYMAN, KY1 - 1205,
Cayman Islands.

(540)



(511) 09, 35, 38, 41, 42 and 45

(210) No. 46951

(220) 03/05/2022

(732) LEMON INC.

P.O. BOX 31119 GRAND PAVILION,
HIBISCUS WAY, 802 WEST BAY ROAD,
GRAND CAYMAN, KY1 - 1205,
Cayman Islands.

(540)



(511) 44

(210) No. 46953

(220) 03/05/2022

(732) ນາງ ບຸນເຫຼືອ ພິມຜາວິງ ແລະ ນາງ ບຸນໂຮມ ພິມຜາວິງ
ບ້ານຕານມີໄຊ, ເມືອງໄຊທານີ ແລະ ບ້ານທ່າດິນແດງ,
ເມືອງໄຊທານີ, ສປປ ລາວ.

(540)



(511) 29

(210) No. 46954

(220) 05/05/2022

(732) ວິທະຍາໄລເຕັກນິກວິຊາຊີບ ຫຼວງພະບາງ
ບ້ານ ຄອຍ, ນະຄອນຫຼວງພະບາງ, ແຂວງ ຫຼວງພະບາງ,
ສປປ ລາວ.

(540)



(511) 32

(210) No. 46955

(220) 05/05/2022

(732) FRASER AND NEAVE, LIMITED

438 Alexandra Road, #20-00 Alexandra
Point, 119958, Singapore.

(540)



(511) 32

(210) No. 46956

(220) 05/05/2022

(732) FRASER AND NEAVE, LIMITED

438 Alexandra Road, #20-00 Alexandra
Point, 119958, Singapore.

(540)

100 PLUS PRO

(511) 32

(210) No. 46957

(220) 05/05/2022

(732) FRASER AND NEAYE, LIMITED

438 Alexandra Road, #20-00 Alexandra
Point, 119958, Singapore.

(540)

100 PLUS PRO
RECOVERY

(511) 32

(210) No. 46958

(220) 05/05/2022

(732) FRASER AND NEAVE, LIMITED

438 Alexandra Road, #20-00 Alexandra
Point, 119958, Singapore.

(540)



(511) 32

(210) No. 46959

(220) 05/05/2022

(732) FRASER AND NEAVE, LIMITED

438 Alexandra Road, #20-00 Alexandra
Point, 119958, Singapore.

(540)



(511) 32

(210) No. 46960

(220) 05/05/2022

(732) FRASER AND NEAVE, LIMITED

43E Alexandra Road, #20-00 Alexandra
Point, 119958, Singapore.

(540)



(511) 32

(210) No. 46961

(220) 05/05/2022

(732) FRASER AND NEAVE, LIMITED

43E Alexandra Road, #20-00 Alexandra
Point, 119958, Singapore.

(540)



(511) 12

(210) No. 46962

(220) 06/05/2022

(732) ບໍລິສັດ ລົງຊິນ ອາໄຫຼລິດຈັກ ຈຳກັດຜູ້ດຽວ

ບ້ານໜອງດ້ວງ, ເມືອງສີໂຄດຕະບອງ, ສປປ ລາວ.

(540)

LUFFMAN

(511) 34

(210) No. 46963

(220) 06/05/2022

(732) Leadon Tobacco International Pte Ltd.

141 Middle Road, #06-07 GSM Building,
188976, Singapore.

(540)

VISUALIZID

(511) 09

(210) No. 46964

(220) 06/05/2022

(732) PPG INDUSTRIES OHIO, INC.

3800 West 143rd Street, Cleveland, State of
Ohio 44111, United States Of America.

(540)

DIGIMATCH

(511) 09

(210) No. 46965

(220) 06/05/2022

(732) PPG INDUSTRIES OHIO, INC.

3800 West 143rd Street, Cleveland, State of
Ohio 44111, United States of America.

(540)



(511) 43

(210) No. 46966

(220) 06/05/2022

(732) Slim Chicken's Holdings, LLC

1088 E Millsap Road, Fayetteville, Arkansas
72703, United States of America.

(540)

Vigor Doctor

(511) 03

(210) No. 46967

(220) 06/05/2022

(732) Zhang Gan

No.H3-26781 Yiwu International Trade Mart,
Zheiiang, China.

(540)



(511) 01

(210) No. 46969

(220) 09/05/2022

(732) SHENZHEN BATIAN ECOTYPIC

ENGINEERING CO., LTD.

30-31F, Joint Headquarters Building, No. 63
Xuefu Road, High-tech Park, Nanshan
District, Shenzhen, P. R., China.

(540)



(511) 35

(210) No. 46970

(220) 10/05/2022

(732) ບໍລິສັດ ວີເຄ ການຄ້າ ຂາອອກ-ຂາເຂົ້າ ຈຳກັດຜູ້ດຽວ
ບ້ານໄຊມຸງຄຸນ, ເມືອງນາຊາຍທອງ, ສປປ ລາວ.

(540)



(511) 35

(210) No. 46971

(220) 10/05/2022

(732) ບໍລິສັດ ວີເຄ ຂາອອກ-ຂາເຂົ້າ ຈຳກັດຜູ້ດຽວ
ບ້ານໄຊມຸງຄຸນ, ເມືອງນາຊາຍທອງ, ສປປ ລາວ.

(540)



(511) 35

(210) No. 46972

(220) 10/05/2022

(732) ບໍລິສັດ ວິເຄ ອັດສະຟານ ເັກໂນໂລຊີ ຈຳກັດຜູ້ດຽວ
ບ້ານໂພນສະຫວັນ, ເມືອງໄຊທານີ, ສປປ ລາວ.

(540)



(511) 37

(210) No. 46973

(220) 10/05/2022

(732) ບໍລິສັດ ວິເຄ ອິນເຕີແນຊັນແນວ ຈຳກັດຜູ້ດຽວ
ບ້ານໄຊມຸງຄຸນ, ເມືອງນາຊາຍທອງ, ສປປ ລາວ.

(540)

drew house

(511) 25

(210) No. 46974

(220) 10/05/2022

(732) Pengliang Yi

No. 337, Baoxing Residents Committee,

Heqing Town, Lengshuijiang, Hunan, China.

(540)

human made

(511) 25

(210) No. 46975

(220) 10/05/2022

(732) Pengliang Yi

No. 337, Baoxing Residents Committee,

Heqing Town, Lengshuijiang, Hunan, China.

(540)

NSK

(511) 07

(210) No. 46976

(220) 10/05/2022

(732) Cui Minfu

No. 13 Meng Village, Lvzhai Town, Linxi
County, Xingtai City, Hebei Province, China.

(540)

WYSE

(511) 05

(210) No. 46977

(220) 10/05/2022

(732) Wyse Industrial (Shenzhen) Co., Ltd

1/F, Building A, No.2, 1st Road, Shangxue
Science and Technology Industrial City,
Xinxue Community, Bantian Street,
Longgang District, Shenzhen, China.

(540)



(511) 03

(210) No. 46978

(220) 11/05/2022

(732) ບໍລິສັດ ອາຊິນນ້ຳມັນເຄື່ອງ ຈຳກັດຜູ້ດຽວ
ບ້ານປາກທ່າງ, ເມືອງສີໂຄດຕະບອງ, ສປປ ລາວ.

(540)



(511) 30

(210) No. 46979

(220) 11/05/2022

(732) ນາງ ນຸດລິດີ ສິລິສັກ
ບ້ານຫາດຊາຍຂາວ, ເມືອງຫາດຊາຍຝອງ, ສປປ ລາວ.

(540)

DAYTONA

(511) 34

(210) No. 46980

(220) 12/05/2022

(732) SETIA WAU TOBACCO IMPORT &
EXPORT SDN. BHD.

No. 88A Jalan Harimau Tarum, Taman
Century, 80250 Johor Bahru, Johor, Malaysia.

(540)

FENZO

(511) 34

(210) No. 46981

(220) 12/05/2022

(732) SETIA WAU TOBACCO IMPORT &
EXPORT SDN. BHD.

No. 88A Jalan Harimau Tarum, Taman
Century, 80250 Johor Bahru, Johor, Malaysia.

(540)



(511) 08

(210) No. 46982

(220) 12/05/2022

(732) Shenzhen Besita Technology co., Ltd.

Room ABD, Floor 7, Senhainuo Kechuang
Building, Dezheng Road, Shilong
Community, Shiyang Street, Baoan District,
Shenzhen, China.

(540)

sensini
Chaussures

(511) 25

(210) No. 46983

(220) 12/05/2022

(732) MISS JEERATCHAYA

MANIRATANAPRUK

No.745/50 Phetchaburi Road, Phaya Thai
Subdistrict, Ratchathewi District, Bangkok,
10400, Thailand.

(540)

META PAY

(511) 09, 36 and 42

(210) No. 46984

(220) 12/05/2022

(732) Meta Platforms, Inc.

1601 willow Road, Menlo Park, California
94025, United States of America.

(540)

XIZI
西子

(511) 07 and 37

(210) No. 46985

(220) 13/05/2022

(732) Jin Rong

No. 231 tongshanhou, Tongshanhoujin
Village, Huangdian, Lanxi, Zhejiang, China.

(540)

XIOLIFT
西奥

(511) 07 and 37

(210) No. 46986

(220) 13/05/2022

(732) Jin Rong

No.231 tongshanhou, Tongshanhoujin

Village, Huangdian, Lanxi, Zhejiang, China.

(540)

SLIM CHICKENS

(511) 43

(210) No. 46997

(220) 16/05/2022

(732) Slim Chicken's Holdings, LLC

1088 E Millsap Road, Fayetteville, Arkansas

72703, United States of America.

(540)



(511) 05

(210) No. 46998

(220) 16/05/2022

(732) DAIO PAPER CORPORATION

2-60, Mishima-Kamiya-cho, Shikokuchuo-
Shi Ehime-ken 799-0402, Japan.

(540)



(511) 05

(210) No. 46999

(220) 16/05/2022

(732) DAIO PAPER CORPORATION

2-60, Mishima-Kamiva-cho, Shikokuchuo-
Shi Ehime-ken 799-0402, Japan.

(540)



(511) 30

(210) No. 47000

(220) 17/05/2022

(732) Mr LI SHENG

ບ້ານ ນາທິງຈອງ, ເມືອງ ຊຳເໜືອ, ແຂວງ ຫົວພັນ,
ສປປ ລາວ.

(540)



(511) 05

(210) No. 47001

(220) 17/05/2022

(732) DSM IP Assets BV

Het Overloon 1, 6411 TE Heerlen,
Netherlands.

(540)



(511) 03 and 35

(210) No. 47002

(220) 17/05/2022

(732) ບໍລິສັດ ແອວ ແລະ ເອັນຄີມ ຂາເຂົ້າ-ຂາອອກ

ຈຳກັດຜູ້ດຽວ

ຖະໜົນ ທາງຮ່ອມ, ບ້ານ ວຽງແກ້ວ, ເມືອງ ໄຊທານີ,
ສປປ ລາວ.

(540)



(511) 12

(210) No. 47003

(220) 17/05/2022

(732) ບໍລິສັດ ຊິນຕ້າລີ້ ການຄ້າ ຂາຍສິ່ງ-ຂາຍຢ່ອຍ

ຈຳກັດຜູ້ດຽວ

ຖະໜົນ ສີທອງ, ບ້ານ ປາກທ້າງ, ເມືອງ ສີໂຄດຕະບອງ,
ສປປ ລາວ.

(540)



(511) 35 and 37

(210) No. 47004

(220) 17/05/2022

(732) ຮ້ານ ແມງໂກ້ໂຟນ ສ່ວນບຸກຄົນ

ບ້ານຝາຍ, ເມືອງ ໄຊເສດຖາ, ສປປ ລາວ.

(540)



(511) 30

(210) No. 47005

(220) 17/05/2022

(732) Yiwu Daqian Food Co., Ltd

No. 1, Danchen 2 Road, Beiyuan Street,

Yiwu City, Zhejiang, China.

(540)



(511) 01

(210) No. 47006

(220) 18/05/2022

(732) ບໍລິສັດ ປ້ອງກັນພືດໄຊງ່ອນ ລາວ ຈຳກັດ (Saigon Plant Protection Limited Company in Laos. ບ້ານ ຫ້ວຍແຮ່, ເມືອງບາຈຽງ, ແຂວງ ຈຳປາສັກ, ສປປ ລາວ.

(540)



(511) 01

(210) No. 47007

(220) 18/05/2022

(732) ບໍລິສັດ ປ້ອງກັນພືດໄຊງ່ອນ ລາວ ຈຳກັດ (Saigon Plant Protection Limited Company in Laos. ບ້ານ ຫ້ວຍແຮ່, ເມືອງບາຈຽງ, ແຂວງ ຈຳປາສັກ, ສປປ ລາວ.

(540)



(511) 01

(210) No. 47008

(220) 18/05/2022

(732) ບໍລິສັດ ປ້ອງກັນພືດໄຊງ່ອນ ລາວ ຈຳກັດ (Saigon Plant Protection Limited Company in Laos. ບ້ານ ຫ້ວຍແຮ່, ເມືອງບາຈຽງ, ແຂວງ ຈຳປາສັກ, ສປປ ລາວ.

(540)

KAFF

(511) 11

(210) No. 47009

(220) 19/05/2022

(732) ບໍລິສັດ ຝີເຮັດໂອໂຕ ຈຳກັດຜູ້ດຽວ
ບ້ານ ໂພນໄຊ, ເມືອງ ໄຊເສດຖາ, ສປປ ລາວ.

(540)



(511) 11

(210) No. 47010

(220) 19/05/2022

(732) ບໍລິສັດ ຝິເຣັດໂອໂຕ ຈຳກັດຜູ້ດຽວ
ບ້ານ ໂພນໄຊ, ເມືອງ ໄຊເສດຖາ, ສປປ ລາວ.

(540)



(511) 11

(210) No. 47011

(220) 19/05/2022

(732) ບໍລິສັດ ຝິເຣັດໂອໂຕ ຈຳກັດຜູ້ດຽວ
ບ້ານ ໂພນໄຊ, ເມືອງ ໄຊເສດຖາ, ສປປ ລາວ.

(540)



(511) 30

(210) No. 47012

(220) 19/05/2022

(732) ບໍລິສັດ ອາຟາ ກະສິກຳ ແລະ ການຄ້າ ຂາອອກ-ຂາເຂົ້າ
ຈຳກັດຜູ້ດຽວ
ບ້ານ ນາຄຳ, ເມືອງສີໂຄດຕະບອງ, ສປປ ລາວ.

(540)

M!ABU

(511) 32

(210) No. 47013

(220) 19/05/2022

(732) Royal Plus Public Company Limited
84/3-7 Rama II Soi 69, Samae Dam, Bang
Khun Thian, Bangkok, 10150, Thailand.

(540)



(511) 03 and 05

(210) No. 47014

(220) 19/05/2022

(732) DAIO PAPER CORPORATION
2-60, MISHIMA-KAMIYA-CHO,
SHIKOKUCHUO-SHI, EHIME-KEN,
JAPAN.

(540)



(511) 32

(210) No. 47015

(220) 20/05/2022

(732) ໂຮງງານ ທະວີໄຊ ຜະລິດ ແລະ ປຸງແຕ່ງ
ນໍ້າໝາກໄມ້ລວມ ສ່ວນບຸກຄົນ
ບ້ານ ພູມວຽງ, ນະຄອນປາກເຊ, ແຂວງ ຈໍາປາສັກ,
ສປປ ລາວ.

(540)



(511) 29

(210) No. 47020

(220) 20/05/2022

(732) Taokaenoi Food & Marketing Public

Company Limited

337 Bond Street Road, Bang Phut Sub-
district, Pak Kret District, Nonthaburi
Province 11120, Thailand.

(540)



(511) 01, 11, 16, 20 and 37

(210) No. 47021

(220) 20/05/2022

(732) SCG Chemicals Public Company Limited

1 Siam Cement Road, Bangsue Sub-District,
Bangsue District, Bangkok, 10800, Thailand.

(540)



(511) 29, 30, 31, 32 and 43

(210) No. 47022

(220) 24/05/2022

(732) ການຈັດຕັ້ງ ສາສະໜາອິດສະລາມ ຢູ່ ສປປ ລາວ
ບ້ານ ຊຽງຍືນ, ເມືອງຈັນທະບູລີ, ສປປ ລາວ.

(540)



(511) 03

(210) No. 47023

(220) 24/05/2022

(732) ໂຮງງານແອວບີແອວ ວິສາຫະກິດສ່ວນບຸກຄົນ
ບ້ານ ໜອງທາເໜືອ, ເມືອງ ຈັນທະບູລີ, ສປປ ລາວ.

(540)



(511) 12

(210) No. 47024

(220) 24/05/2022

(732) A & P SIAM NEO GROUP PUBLIC
COMPANY LIMITED

2/4 MOO 8 SOI SUKSAWAT 78,
SUKSAWAT ROAD, BANGCHAK,
PHRAPRADAENG, SAMUTPRAKARN
10130, THAILAND.

(540)



(511) 08

(210) No. 47025

(220) 24/05/2022

(732) Yuyao Wanshu Hardware Co., Ltd

Xujia Chang, Ganjialu Village, Langxia
Street, Yuyao City, Zhejiang Province, 15480
, China.

(540)

HAILANG

(511) 07

(210) No. 47026

(220) 24/05/2022

(732) Ningbo Hailang Electric Co., Ltd.

Wuxing Village, Qiaotou Town, Cixi City,
Zhejiang Province, 315300, China.

(540)

POMELO

(511) 09, 36 and 42

(210) No. 47030

(220) 24/05/2022

(732) Pomelo Group Ltd

Level 39 One Canada Square, London, E14
5AB, United Kingdom.

(540)



(511) 12

(210) No. 47031

(220) 25/05/2022

(732) ບໍລິສັດ ໂບເວີຍ ເທຣດດິ້ງ ຈຳກັດຜູ້ດຽວ
ບ້ານ ວັດໂຕນ້ອຍທົ່ງ, ເມືອງສີໂຄດຕະບອງ,
ສປປ ລາວ.

(540)



(511) 12

(210) No. 47032

(220) 25/05/2022

(732) ບໍລິສັດ ໂບເວີຍ ເທຣດດິ້ງ ຈຳກັດຜູ້ດຽວ
ບ້ານ ວັດໂຕນ້ອຍທົ່ງ, ເມືອງສີໂຄດຕະບອງ,
ສປປ ລາວ.

(540)

Arctic Vision

(511) 05, 10, 35, 42 and 44

(210) No. 47034

(220) 26/05/2022

(732) ARCTIC VISION (HONG KONG)
LIMITED

19th Floor, Three Exchange Square, 8
Connaught Place, Central, Hong Kong.

(540)

ARCATUS

(511) 05, 10, 35, 42 and 44

(210) No. 47035

(220) 26/05/2022

(732) ARCTIC VISION (HONG KONG)
LIMITED

19th Floor, Three Exchange Square, 8
Connaught Place, Central, Hong Kong.

(540)

iTEAR

(511) 05, 10, 35, 42 and 44

(210) No. 47036

(220) 26/05/2022

(732) ARCTIC VISION (HONG KONG)
LIMITED

19th Floor, Three Exchange Square, 8
Connaught Place, Central, Hong Kong.

(540)



(511) 03

(210) No. 47037

(220) 26/05/2022

(732) Shengyun Hu

No. 69, Shanguantang Natural Village,
Gaoping Village, Shigang Town, Xinjian
County, Nanchang, Jiangxi., China.

(540)



(511) 32

(210) No. 47038

(220) 26/05/2022

(732) THE COCA-COLA COMPANY
ONE COCA-COLA PLAZA, ATLANTA,
GEORGIA 30313,
UNITED STATES OF AMERICA.

(540)



(511) 32

(210) No. 47039

(220) 26/05/2022

(732) THE COCA-COLA COMPANY
ONE COCA-COLA PLAZA, ATLANTA,
GEORGIA 30313,
UNITED STATES OF AMERICA.

(540)



(511) 35

(210) No. 47040

(220) 26/05/2022

(732) ບໍລິສັດ ໂບເວີຍ ເທຣດດິ້ງ ຈຳກັດຜູ້ດຽວ
ບ້ານ ວັດໄຕນ້ອຍທົ່ງ, ເມືອງສີໂຄດຕະບອງ,
ສປປ ລາວ.

(540)



(511) 35

(210) No. 47041

(220) 27/05/2022

(732) ບໍລິສັດ ຮຸ່ງອາລຸນເທັກໂນໂລຢີ ຈຳກັດ
ບ້ານ ຮ່ອງຄ້າ, ເມືອງ ຈັນທະບູລີ, ສປປ ລາວ.

(540)



(511) 32

(210) No. 47042

(220) 30/05/2022

(732) ບໍລິສັດທີ່ດີແອສນ້ຳດື່ມຊຸມຊົນ ຈຳກັດຜູ້ດຽວ
ບ້ານ ໜອງແມງດາ, ເມືອງໄຊ, ແຂວງ ອຸດົມໄຊ,
ສປປ ລາວ.

(540)



(511) 09

(210) No. 47043

(220) 30/05/2022

(732) NEW YORK STATE DEPARTMENT OF
ECONOMIC DEVELOPMENT
625 BROADWAY, ALBANY, NEW YORK
12245, UNITED STATES OF AMERICA.

(540)



(511) 14

(210) No. 47044

(220) 30/05/2022

(732) NEW YORK STATE DEPARTMENT OF
ECONOMIC DEVELOPMENT
625 BROADWAY, ALBANY, NEW YORK
12245, UNITED STATES OF AMERICA.

(540)



(511) 18

(210) No. 47045

(220) 30/05/2022

(732) NEW YORK STATE DEPARTMENT OF
ECONOMIC DEVELOPMENT
625 BROADWAY, ALBANY, NEW YORK
12245, UNITED STATES OF AMERICA.

(540)



(511) 25

(210) No. 47046

(220) 30/05/2022

(732) NEW YORK STATE DEPARTMENT OF
ECONOMIC DEVELOPMENT
625 BROADWAY, ALBANY, NEW YORK
12245, UNITED STATES OF AMERICA.

(540)

VASATA

(511) 09

(210) No. 47047

(220) 31/05/2022

(732) TP-LINK CORPORATION LIMITED
ROOM 901, 9/F., NEW EAST OCEAN
CENTRE, 9 SCIENCE MUSEUM ROAD,
TSIM SHA TSUI, KOWLOON,
HONG KONG.

ພາກທີ III

(Part III)

ເຄື່ອງໝາຍການຄ້າ

Trademarks

2. ຜົນການຈົດທະບຽນ

(Registration)

ຄຳອະທິບາຍກ່ຽວກັບລະຫັດຫຍໍ້

(Introduction of Codes)

- (540) ເຄື່ອງໝາຍການຄ້າ (Trademark)
- (511) ໝວດ (Nice Classification)
- (210) ເລກທີ ຄຳຮ້ອງ (Number of the application)
- (220) ວັນທີ ຄຳຮ້ອງ (Date of filing of the application)
- (732) ຊື່ ແລະ ທີ່ຢູ່ ຂອງຜູ້ຍື່ນຄຳຮ້ອງ (Name and Address of applicant)
- (111) ເລກທີ ການຈົດທະບຽນເຄື່ອງໝາຍການຄ້າ (Number of the registration)
- (180) ວັນໝົດອາຍຸຂອງການຈົດທະບຽນ (Expiration date of the registration)

(540)

LUXERINE

(511) 03

(210) No. 46224

(220) 20/09/2021

(732) MORAL FALCON LIMITED

FLAT/RM 901, YIP FUNG BUILDING 2-I2

D'AGUILAR STREET CENTRAL,

HONG KONG

(111) No. 55102

(180) 20/09/2031

(540)

barenbliss

(511) 03

(210) No. 46225

(220) 20/09/2021

(732) MORAL FALCON LIMITED

FLAT/RM 901, YIP FUNG BUILDING 2-I2

D'AGUILAR STREET CENTRAL,

HONG KONG

(111) No. 55103

(180) 20/09/2031

(540)



(511) 05 and 32

(210) No. 46184

(220) 02/09/2021

(732) ບໍລິສັດ 101 ກະສິກໍາ (ລາວ) ຈຳກັດ

ບ້ານຫ້ວຍເຕື້ອ, ເມືອງໂພນໂຮງ, ແຂວງ ວຽງຈັນ,
ສປປ ລາວ.

(111) No. 55104

(180) 02/09/2031

(540)

P&N 888

(511) 03 and 25

(210) No. 46209

(220) 14/09/2021

(732) ຮ້ານ ປານຕາວັນ ຝີ ແອນ ເອັນ 888

ຖະໜົນ A1 ບ້ານ ໂພນສະຫວ່າງໄຕ້, ເມືອງ
ນຄອນໄກສອນພິມວິຫານ ແຂວງສະຫວັນນະເຂດ,
ສປປ ລາວ.

(111) No. 55105

(180) 14/09/2031

(540)

**Healthier days,
Wellbeing for life**

(511) 30

(210) No. 46484

(220) 03/12/2021

(732) Ezaki Glico Kabushiki Kaisha (also trading as

Ezaki Glico Co., Ltd.)

6-5, Utajima 4-chome, Nishiyodogawa-ku,

Osaka, Japan

(111) No. 55124

(180) 03/12/2031

ພາກທີ III
(Part III)
ເຄື່ອງໝາຍການຄ້າ
Trademarks

3. ການຕໍ່ອາຍຸ
(Renewal)

ຄຳອະທິບາຍກ່ຽວກັບລະຫັດຫຍໍ້
(Introduction of Codes)

- (540) ເຄື່ອງໝາຍການຄ້າ (Trademark)
- (511) ໝວດ (Nice Classification)
- (210) ເລກທີ ຄຳຮ້ອງ (Number of the application)
- (220) ວັນທີ ຄຳຮ້ອງ (Date of filing of the application)
- (732) ຊື່ ແລະ ທີ່ຢູ່ ຂອງຜູ້ຍື່ນຄຳຮ້ອງ (Name and Address of applicant)
- (111) ເລກທີການຈັດທະບຽນເຄື່ອງໝາຍການຄ້າ (Number of the registration)
- (180) ການຕໍ່ອາຍຸການຈັດທະບຽນ (Expiration date of the renewal)

ພາກທີ III

(Part III)

ເຄື່ອງໝາຍການຄ້າ

Trademarks

4. ການປ່ຽນແປງ

(Changes)

ພາກທີ III
(Part III)
ເຄື່ອງໝາຍການຄ້າ
Trademarks

5. ການດັດແກ້
(Amendments)

ພາກທີ IV

(Part IV)

ເຄື່ອງໝາຍການຄ້າຜ່ານລະບົບມາດຣິດ

Trademarks via Madrid Protocol

1. ຄໍາຮ້ອງ

(Applications)

ຄໍາອະທິບາຍກ່ຽວກັບລະຫັດຫຍໍ້ (Introduction of Codes)

- (540) ເຄື່ອງໝາຍການຄ້າ (Trademark)
- (511) ໝວດ (Nice Classification)
- (210) ເລກທີ ຄໍາຮ້ອງ (Number of the application)
- (220) ວັນທີ ຄໍາຮ້ອງ (Date of filing of the application)
- (732) ຊື່ ແລະ ທີ່ຢູ່ ຂອງຜູ້ຍື່ນຄໍາຮ້ອງ (Name and Address of applicant)

(540)



(511) 32 and 43

(210) No. M/1402621

(220) 28/06/2022

(732) Boost Juice Holdings Pty Ltd ACN 102 379
591

Level 8, M-City Business District 2107-2125
Dandenong Road CLAYTON VIC 3168,
Australia

(540)



(511) 25 and 35

(210) No. M/1490402

(220) 01/03/2022

(732) RENWAR FASHION MANUFACTURING
& MARKETING (1993) LTD.

13 Arie Shenkar st. Rishon Le'zion, Israel

(540)

NOMIC

(511) 09

(210) No. M/1657573

(220) 07/07/2022

(732) DBR SYSTEMS PTE. LTD.

1 ROCHOR CANAL ROAD, #02-33 SIM
LIM SQUARE 188504, Singapore

(540)

BYHERZYN

(511) 05

(210) No. M/1670942

(220) 26/07/2022

(732) Zymeworks Inc.

Suite 800 - 114 East 4th Avenue Vancouver
BC V5T 1G4, Canada

(540)

ZIHERA

(511) 05

(210) No. M/1671312

(220) 26/07/2022

(732) Zymeworks Inc.

Suite 800 - 114 East 4th Avenue Vancouver

BC V5T 1G4, Canada

(540)

BARBARABANG

(511) 09, 38, 41 and 42

(210) No. M/1676552

(220) 18/03/2022

(732) Stropus Ltd.

7-9 Riga Fereou, Lizantia Court, office 310,

Agioi Omologites CY-1087 Nicosia, Cyprus

(540)

Schaeffler DuraWave

(511) 07 and 09
(210) No. M/1676634
(220) 16/02/2022
(732) Schaeffler Technologies AG & Co. KG
Industriestr. 1-3 91074 Herzogenaurach,
Germany

(540)

SKYWORTH

(511) 09 and 10
(210) No. M/1676655
(220) 02/03/2022
(732) SKYWORTH GROUP CO., LTD.
22-24/F, Skyworth Semiconductor Design
Bldg, 18 High-Tech Sout 4th Rd, Nanshan
Dist 518057 Shenzhen, China

(540)



(511) 29 and 30

(210) No. M/1676757

(220) 20/05/2022

(732) Henan Shuanghui Investment & Development
Co., Ltd.

No. 1, Shuanghui Road, Luohe City 462000
Henan Province, China

(540)

VIMERLEA'S SPRING

(511) 25

(210) No. M/1676760

(220) 17/05/2022

(732) Weng Yibing

No. 10, Eleventh Lane, Yizai District,
Dongming, Gurao Town, Chaoyang District,
Shantou City 515000 Guangdong Province,
China

(540)

NEWTIMES

(511) 26

(210) No. M/1676787

(220) 18/05/2022

(732) Lordhair (Qingdao) Co., Ltd

B-807, Lubang Plaza, No.177, Shandong
Road, Shibe District, Qingdao City
Shandong Province, China

(540)

DUX DUCIS

(511) 09

(210) No. M/1676824

(220) 26/05/2022

(732) Dux Ducis Technology Co., Ltd.

Room 901, Block 18, Zhonghaixin
Innovation Industrial Park, Jihua, Longgang,
Shenzhen 518000 Guangdong, China

(540)

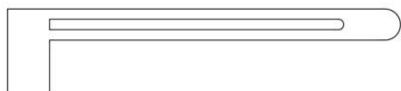

(511) 09, 12, 14, 16, 17, 18, 25, 28, 35, 37, 41 and 42

(210) No. M/1676855

(220) 10/12/2021

(732) PIRELLI & C. S.p.A.

Viale Piero e Alberto Pirelli 25 I-20126
MILANO, Italy

(540)

DAREU

(511) 28

(210) No. M/1676903

(220) 16/05/2022

(732) Dongguan Dareu Electronics Audio Co., Ltd

Room 301, building 3, Yuhua Rd 3, Juzhou,
Shijie Town, Dongguan City 523000
Guangdong, China

(540)

Mornwell

(511) 21

(210) No. M/1676907

(220) 14/06/2022

(732) Shenzhen Risun Technology Co., Ltd.

Room 101, Building A, Ximusheng Low
Carbon Industrial Park, No. 6 Xinmu Avenue,
Xinmu Community, Pinghu Street, Longgang
District, Shenzhen City Guangdong Province,
China

(540)

维希儿
WEIXIER

(511) 18

(210) No. M/1676936

(220) 31/05/2022

(732) Baoding Qingmu Leather Manufacturing Co.,
Ltd.

Alley No. 5, North of Renhe Middle Rd.,
Baigou New Town, Baoding 071000 Hebei,
China

(540)

EyeGiene

(511) 05

(210) No. M/1677068

(220) 11/07/2022

(732) BJL Medical, LLC

9000 Crow Canyon Road, Ste S, #348 Danville
CA 94506, United States of America

(540)

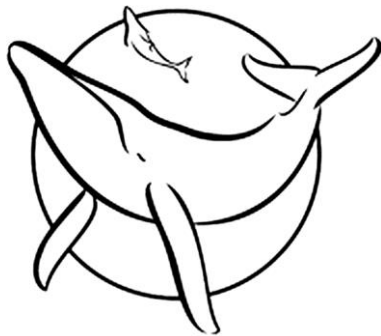

SEA SHEPHERD

(511) 16, 25, 35, 41 and 42

(210) No. M/1677168

(220) 08/03/2022

(732) Sea Shepherd Conservation Society

209 E. Alameda Ave. #205 Burbank CA
91502, United States of America

(540)

NET ZERO

(511) 22

(210) No. M/1677189

(220) 21/03/2022

(732) AmSafe Bridport Limited

The Court, West Street Bridport, Dorset DT6
3QU, United Kingdom

(540)



(511) 33

(210) No. M/1677373

(220) 04/07/2022

(732) Lark Distillery Pty Ltd

Level 1, 30 Argyle Street HOBART TAS
7000, Australia

(540)

Class Navi

(511) 09, 35, 41 and 42

(210) No. M/1677430

(220) 21/02/2022

(732) KUMON INSTITUTE OF EDUCATION
CO., LTD.

5-6-6 Nishinakajima, Yodogawa-ku, Osaka-
shi Osaka 532-8511, Japan

(540)

uBioEXPLORER

(511) 09 and 10

(210) No. M/1677472

(220) 31/05/2022

(732) Shanghai United Imaging Healthcare Co.,
Ltd.

No. 2258 Chengbei Rd., Jiading District
Shanghai, China

(540)

Doosan Enerbility

(511) 06, 07, 09, 11, 35, 36, 37, 39, 40 and 42

(210) No. M/1677567

(220) 10/02/2022

(732) DOOSAN CORPORATION

275, Jangchungdan-ro, Jung-gu Seoul,
Republic of Korea

(540)

YASWARA

(511) 03

(210) No. M/1677599

(220) 24/02/2022

(732) JETHARAM NEMARAM GEHLOT

101, Shree White Heights Apartment,
saraswati Nagar, Hirawadi Road, Panchavati,
Nashik Maharashtra 422003, India

(540)



(511) 01, 04, 07, 08, 11, 36, 38, 39 and 40

(210) No. M/1677668

(220) 29/11/2021

(732) PIRELLI & C. S.p.A.

Viale Piero e Alberto Pirelli 25 I-20126

Milano, Italy

(540)



(511) 09, 28 and 41

(210) No. M/1677678

(220) 12/01/2022

(732) Euro Games Technology Ltd.

4, "Maritsa" Str., "Vranya-Lozen-

Triugulnika" BG-1151 Sofia, Bulgaria

(540)

BYRYZN

(511) 03, 05 and 10

(210) No. M/1677746

(220) 27/04/2022

(732) HUGEL INC.

61-20, Sinbuk-ro, Sinbuk-eup, Chuncheon-si
Gangwon-do, Republic of Korea

ພາກທີ IV
(Part IV)

ເຄື່ອງໝາຍການຄ້າຜ່ານລະບົບມາດຣິດ
Trademarks via Madrid Protocol

2. ຜົນການຈົດທະບຽນ
(Registration)

ຄຳອະທິບາຍກ່ຽວກັບລະຫັດຫຍໍ້
(Introduction of Codes)

- (540) ເຄື່ອງໝາຍການຄ້າ (Trademark)
- (511) ໝວດ (Nice Classification)
- (210) ເລກທີ ຄຳຮ້ອງ (Number of the application)
- (220) ວັນທີ ຍື່ນຄຳຮ້ອງ (Date of filing of the application)
- (732) ຊື່ ແລະ ທີ່ຢູ່ ຂອງຜູ້ຍື່ນຄຳຮ້ອງ (Name and Address of applicant)
- (111) ເລກທີການຈົດທະບຽນເຄື່ອງໝາຍການຄ້າ (Number of the registration)
- (180) ວັນໝົດອາຍຸຂອງການຈົດທະບຽນ (Expiration date of the registration)

(540)



(511) 01, 04, 05, 16, 17, 19, 40 and 44

(210) No. M/1473660

(220) 27/05/2021

(732) UPM-Kymmene Corporation

Alvar Aallon katu 1 FI-00100 Helsinki,

Finland

(111) No. M/1473660

(180) 28/08/2028

(540)

OPENBLUE

(511) 09, 35, 37 and 42

(210) No. M/1542181

(220) 28/09/2021

(732) Tyco Fire & Security GmbH

Victor von Bruns-Strasse 21 CH-8212

Neuhausen am Rheinfall, Switzerland

(111) No. M/1542181

(180) 26/05/2030

(540)

The logo consists of the letters 'R', '&', and 'B' in a bold, sans-serif font. The ampersand is stylized and positioned between the 'R' and 'B'.

(511)

(210) No. M/1627427

(220) 28/05/2021

(732) Jiangsu Nine Dragon Ball Co., Ltd.

8th Floor, Phoenix Plaza, 66 Dongwu North

Road, Wuzhong District, Suzhou City Jiangsu

Province, China

(111) No. M/1627427

(180) 28/05/2031

(540)

The logo consists of the word 'AKEEGA' in a bold, sans-serif font.

(511) 05

(210) No. M/1629915

(220) 06/01/2022

(732) Janssen Pharmaceutica NV

Turnhoutseweg 30 B-2340 Beerse, Belgium

(111) No. M/1629915

(180) 27/10/2031

(540)

HONOR CLUB

(511) 09, 35, 38 and 41

(210) No. M/1636791

(220) 21/10/2021

(732) Honor Device Co., Ltd.

Suite 3401, Unit A, Building 6, Shum Yip
Sky Park, No. 8089, Hongli West Road,
Xiangmihu Street, Futian District, Shenzhen
518040 Guangdong, China

(111) No. M/1636791

(180) 21/10/2031

(540)

FLIX

(511) 34

(210) No. M/1636892

(220) 15/10/2021

(732) TAN KHER WEI

113-05-08, Jalan Kenari, Desaria, 11900
Bayan Lepas Penang, Malaysia

(111) No. M/1636892

(180) 15/10/2031

(540)

RASAKU

(511) 29, 30 and 32

(210) No. M/1636967

(220) 11/10/2021

(732) RASAKU PTE. LIMITED

21 TAGORE LANE 787479, SINGAPORE

(111) No. M/1636967

(180) 11/10/2031

(540)

PARCELHUB

(511) 39

(210) No. M/1637041

(220) 01/09/2021

(732) PPS Global Network Sdn. Bhd.

No. 63A, Jalan SS 25/2 Taman Bukit Emas,

47301 Petaling Jaya Selangor, Malaysia

(111) No. M/1637041

(180) 01/09/2031

(540)

ZENSHISO

(511) 05

(210) No. M/1637332

(220) 12/10/2021

(732) PT. Bina Karya Prima

Jl. Raya Bekasi Km. 27, Pejuang, Medan
Satria, Bekasi Jawa Barat, Indonesia

(111) No. M/1637332

(180) 12/10/2031

(540)



สุพรรณภูมิ

(511) 05

(210) No. M/1637358

(220) 10/09/2021

(732) Suvarnabhumi Osod Co., Ltd.

168 Moo 6, Soi Srisamphan 4, Bangphli-
Tamru Road, Phraeksamai 10280 Mueang,
Samut Prakan, Thailand

(111) No. M/1637358

(180) 10/09/2031

(540)



(511) 01, 04 and 17

(210) No. M/1637803

(220) 17/10/2021

(732) Chevron Phillips Chemical Company LP
10001 Six Pines Drive The Woodlands TX
77380, United States of America

(111) No. M/1637803

(180) 17/10/2031

(540)

**IDEMITSU
NANOUREA**

(511) 04

(210) No. M/1638095

(220) 22/11/2021

(732) Idemitsu Kosan Co., Ltd.
2-1, Otemachi 1-chome, Chiyoda-ku Tokyo
100-8321, Japan

(111) No. M/1638095

(180) 22/11/2031

(540)

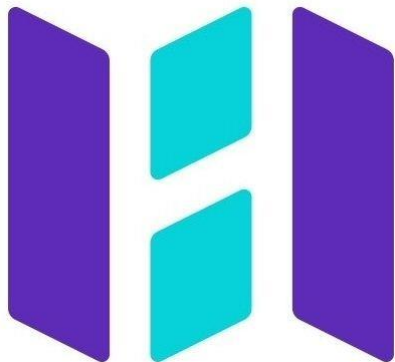

(511) 39

(210) No. M/1638356

(220) 08/10/2021

(732) HANATOUR Service Inc.

41 Insadong 5-gil, Jongno-gu Seoul,
Republic of Korea

(111) No. M/1638356

(180) 08/10/2031

(540)



(511) 39

(210) No. M/1638442

(220) 08/10/2021

(732) HANATOUR Service Inc.

41 Insadong 5-gil, Jongno-gu Seoul,
Republic of Korea

(111) No. M/1638442

(180) 08/10/2031

(540)



(511) 39

(210) No. M/1638444

(220) 08/10/2021

(732) HANATOUR Service Inc.

41 Insadong 5-gil, Jongno-gu Seoul,
Republic of Korea

(111) No. M/1638444

(180) 08/10/2031

(540)

EulerRTOS

(511) 09 and 42

(210) No. M/1638907

(220) 02/11/2021

(732) HUAWEI TECHNOLOGIES CO., LTD.

Administration Building Huawei
Technologies Co., Ltd., Bantian, Longgang
District Shenzhen, China

(111) No. M/1638907

(180) 02/11/2031

(540)

Soloop

(511) 09

(210) No. M/1639148

(220) 22/09/2021

(732) GUANGDONG OPPO MOBILE
TELECOMMUNICATIONS CORP., LTD.

No.18 Haibin Road, Wusha, Chang'an,
Dongguan Guangdong, China

(111) No. M/1639148

(180) 22/09/2031

(540)

**The Cambridge Union
Society**

(511) 41

(210) No. M/1639307

(220) 27/08/2021

(732) Cambridge Union Society Enterprises Limited
9a Bridge Street Cambridge, Cambridgeshire
CB2 1UB, United Kingdom

(111) No. M/1639307

(180) 27/08/2031

(540)

Geeneu

(511) 09

(210) No. M/1639431

(220) 21/10/2021

(732) Hunan Newman Digital Technology Co., Ltd.

No. 2 Lixiang East Road, Economic and
Technology Development Zone, Changsha
Hunan Province, China

(111) No. M/1639431

(180) 21/10/2031

(540)

Bestguard

(511) 07, 08, 09, 21 and 22

(210) No. M/1639474

(220) 28/09/2021

(732) XIAMEN HAPSUY INDUSTRY&TRADE

CO., LTD

ROOM 2006, NO.39, YUXIU LANE,

SIMING DISTRICT, XIAMEN 361000

FUJIAN PROV, CHINA

(111) No. M/1639474

(180) 28/09/2031

(540)



(511) 30

(210) No. M/1639489

(220) 21/09/2021

(732) Julie's Manufacturing Sdn. Bhd.

A.G. 6876, Alor Gajah Industrial Estate,

78000 Alor Gajah Melaka, Malaysia

(111) No. M/1639489

(180) 21/09/2031

(540)



(511)

(210) No. M/1639613

(220) 22/11/2021

(732) Idemitsu Kosan Co., Ltd.

2-1, Otemachi 1-chome, Chiyoda-ku Tokyo

100-8321, Japan

(111) No. M/1639613

(180) 22/11/2031

(540)

**Cambridge Union
Debating Society**

(511) 41

(210) No. M/1639667

(220) 27/09/2021

(732) Cambridge Union Society Enterprises Limited

9a Bridge Street Cambridge CB2 1UB,

United Kingdom

(111) No. M/1639667

(180) 27/09/2031

(540)



(511) 04

(210) No. M/1639833

(220) 22/11/2021

(732) Idemitsu Kosan Co., Ltd.

2-1, Otemachi 1-chome, Chiyoda-ku Tokyo

100-8321, Japan

(111) No. M/1639833

(180) 22/11/2031

(540)



(511) 04

(210) No. M/1639834

(220) 22/11/2021

(732) Idemitsu Kosan Co., Ltd.

2-1, Otemachi 1-chome, Chiyoda-ku Tokyo

100-8321, Japan

(111) No. M/1639834

(180) 22/11/2031

(540)

Quintet Guard

(511)

(210) No. M/1639835

(220) 22/11/2021

(732) Idemitsu Kosan Co., Ltd.

2-1, Otemachi 1-chome, Chiyoda-ku Tokyo

100-8321, Japan

(111) No. M/1639835

(180) 22/11/2031

(540)

Septet Guard

(511) 04

(210) No. M/1639836

(220) 22/11/2021

(732) Idemitsu Kosan Co., Ltd.

2-1, Otemachi 1-chome, Chiyoda-ku Tokyo

100-8321, Japan

(111) No. M/1639836

(180) 22/11/2031

(540)

RELX

(511)

(210) No. M/1640212

(220) 01/12/2021

(732) Shenzhen Relx Technology Co., Ltd

4th Floor, Building 2, Wangda Industrial

Park, West of Songbai Road, Tangtou

Community, Shiyan Street, Baoan District

518100 Shenzhen, China

(111) No. M/1640212

(180) 01/12/2031

(540)

DAREU

(511) 21

(210) No. M/1640462

(220) 30/09/2021

(732) Dongguan Dareu Electronics Audio Co., Ltd

Room 301, Building 3, Yuhua Rd 3, Juzhou,

Shijie Town, Dongguan City 523000

Guangdong, China

(111) No. M/1640462

(180) 30/09/2031

(540)

 **ZOJIRUSHI**

(511) 07, 11 and 21

(210) No. M/1640514

(220) 25/10/2021

(732) ZOJIRUSHI CORPORATION

20-5, 1-Chome, Tenma, Kita-ku, Osaka-shi

Osaka 530-8511, Japan

(111) No. M/1640514

(180) 25/10/2031

(540)



(511) 07, 11 and 21

(210) No. M/1640515

(220) 25/10/2021

(732) ZOJIRUSHI CORPORATION

20-5, 1-Chome, Tenma, Kita-ku, Osaka-shi

Osaka 530-8511, Japan

(111) No. M/1640515

(180) 25/10/2031

(540)



(511) 07, 11 and 21

(210) No. M/1640619

(220) 25/10/2021

(732) ZOJIRUSHI CORPORATION

20-5, 1-Chome, Tenma, Kita-ku, Osaka-shi

Osaka 530-8511, Japan

(111) No. M/1640619

(180) 25/10/2031

(540)

LEAWOD

(511) 06 and 19

(210) No. M/1641028

(220) 25/10/2021

(732) Sichuan Leawod Window & Door Profile Co.,

Ltd

Economic Development Zone, Guanghan

City, Deyang 618300 Sichuan, China

(111) No. M/1641028

(180) 25/10/2031

ພາກທີ IV

(Part IV)

ເຄື່ອງໝາຍການຄ້າຜ່ານລະບົບມາດຣິດ

Trademarks via Madrid Protocol

3. ຜົນການຕໍ່ອາຍຸ

(Renewal)

ຄຳອະທິບາຍກ່ຽວກັບລະຫັດຫຍໍ້

(Introduction of Codes)

- (540) ເຄື່ອງໝາຍການຄ້າ (Trademark)
- (511) ໝວດ (Nice Classification)
- (210) ເລກທີ ຄຳຮ້ອງ (Number of the application)
- (220) ວັນທີ ຍື່ນຄຳຮ້ອງ (Date of filing of the application)
- (732) ຊື່ ແລະ ທີ່ຢູ່ ຂອງຜູ້ຍື່ນຄຳຮ້ອງ (Name and Address of applicant)
- (111) ເລກທີການຈົດທະບຽນເຄື່ອງໝາຍການຄ້າ (Number of the registration)
- (180) ການຕໍ່ອາຍຸຂອງການຈົດທະບຽນ (Expiration date of the renewal)

ພາກທີ IV

(Part IV)

ເຄື່ອງໝາຍການຄ້າຜ່ານລະບົບມາດຣິດ

Trademarks via Madrid Protocol

4. ການປ່ຽນແປງ

(Changes)

ພາກທີ IV

(Part IV)

ເຄື່ອງໝາຍການຄ້າຜ່ານລະບົບມາດຣິດ

Trademarks via Madrid Protocol

5. ການດັດແກ້

(Amendments)

ພາກທີ V
(Part V)
ຖິ່ນກຳເນີດ
Geographical Indications

1. ຄຳຮ້ອງ
(Applications)

ພາກທີ V
(Part V)
ຖິ່ນກຳເນີດ
Geographical Indications

2. ຜົນການຈົດທະບຽນ
(Registration)

ພາກທີ V

(Part V)

ຖິ່ນກຳເນີດ

Geographical Indications

3. ການປ່ຽນແປງ

(Changes)

ພາກທີ V
(Part V)
ຖິ່ນກຳເນີດ
Geographical Indications

4. ການດັດແກ້
(Amendments)

ພາກທີ VI

(Part VI)

ພັນພືດໃໝ່

New Plant Varieties

1. ຄໍາຮ້ອງ

(Applications)

ພາກທີ VI

(Part VI)

ພັນພືດໃໝ່

New Plant Varieties

2. ຜົນການຈົດທະບຽນ

(Registration)

ພາກທີ VI

(Part VI)

ພັນພືດໃໝ່

New Plant Varieties

3. ການປ່ຽນແປງ

(Changes)

ພາກທີ VI

(Part VI)

ພັນພືດໃໝ່

New Plant Varieties

4. ການດັດແກ້

(Amendments)

ພາກທີ VII

(Part VII)

ລິຂະສິດ ແລະ ສິດກ່ຽວຂ້ອງກັບລິຂະສິດ

Copyrights and Related Rights

1. ການແຈ້ງຂໍ້ມູນ

(Notifications)

ພາກທີ VII

(Part VII)

ລິຂະສິດ ແລະ ສິດກ່ຽວຂ້ອງກັບລິຂະສິດ

Copyrights and Related Rights

2. ການປ່ຽນແປງ

(Changes)

ພາກທີ VIII

(Part VIII)

**ການແກ້ໄຂຂໍ້ຂັດແຍ່ງທາງດ້ານບໍລິຫານກ່ຽວກັບການຈົດທະບຽນຊັບ
ສິນອຸດສາຫະກຳ ແລະ ພັນພືດໃໝ່**

**Administrative Dispute Resolutions on the Registration of
Industrial Property and New Plant Varieties**

1. ຜົນການຄັດຄ້ານຄຳຮ້ອງ

(Result of Oppositions)

ພາກທີ VIII

(Part VIII)

**ການແກ້ໄຂຂໍ້ຂັດແຍ່ງທາງດ້ານບໍລິຫານກ່ຽວກັບການຈົດທະບຽນຊັບ
ສິນອຸດສາຫະກຳ ແລະ ພັນພືດໃໝ່**

**Administrative Dispute Resolutions on the Registration of
Industrial Property and New Plant Varieties**

2. ຜົນການແຈ້ງປະຕິເສດ

(Result of Refusals)

ພາກທີ VIII

(Part VIII)

**ການແກ້ໄຂຂໍ້ຂັດແຍ່ງທາງດ້ານບໍລິຫານກ່ຽວກັບການຈັດທະບຽນຊັບ
ສິນອຸດສາຫະກຳ ແລະ ພັນພືດໃໝ່**

**Administrative Dispute Resolutions on the Registration of
Industrial Property and New Plant Varieties**

**3. ຜົນການຍົກເລີກ ຫຼື ລົບລ້າງ ຂອງການຈັດທະບຽນ
(Result of Cancellation or Invalidation of Registration)**