



ສາທາລະນະລັດ ປະຊາທິປະໄຕ ປະຊາຊົນລາວ
LAO PEOPLE'S DEMOCRATIC REPUBLIC

ກະຊວງ ອຸດສາຫະກຳ ແລະ ການຄ້າ
ກົມຊັບສິນທາງປັນຍາ

MINISTRY OF INDUSTRY AND COMMERCE
DEPARTMENT OF INTELLECTUAL PROPERTY

ຈົດໝາຍເຫດທາງລັດຖະການ
ກ່ຽວກັບ ຊັບສິນທາງປັນຍາ
ຢູ່ ສປປ ລາວ

OFFICIAL GAZETTE ON INTELLECTUAL PROPERTY
IN LAO PDR

ສະບັບທີ (Vol.) 179

ພາກທີ I

(Part I)

ສິດທິບັດ ແລະ ອະນຸສິດທິບັດ (Patent and Petty Patent)

1. ຄໍາຮ້ອງ

(Applications)

ຄໍາອະທິບາຍກ່ຽວກັບລະຫັດຫຍໍ້

(Introduction of Codes)

- (21) ເລກທີ ຄໍາຮ້ອງ (Filing Number)
- (22) ວັນທີ ຍືນຄໍາຮ້ອງ (Filing Date)
- (30) ວັນທີ ບຸລິມະສິດ (Priority Date)
- (43) ວັນທີເຜີຍແຜ່ (Publication Date)
- (51) ໝວດ (International Patent Classification)
- (54) ຊື່ຂອງການປະດິດ (Title)
- (57) ບົດຄັດຫຍໍ້ (Abstract)
- (71) ຊື່ ແລະ ທີ່ຢູ່ ເຈົ້າຂອງສິດທິບັດ ແລະ ອະນຸສິດທິບັດ (Owner Name and Address)
- (72) ຊື່ຜູ້ປະດິດ (Inventor Name)
- (74) ຊື່ຕົວແທນ (Representative Name)
- (55) ຮູບພາບ (Pictures)

ພາກທີ I (Part I)

ສິດທິບັດ ແລະ ອະນຸສິດທິບັດ (Patent and Petty Patent)

2. ຜົນການອອກສິດທິບັດ ແລະ ອະນຸສິດທິບັດ (Grant of Patents and Petty Patents)

ຄຳອະທິບາຍກ່ຽວກັບລະຫັດຫຍໍ້

(Introduction of Codes)

- (11) ເລກທິ (Grant Number)
- (21) ເລກທິ ຄຳຮ້ອງ (Filing Number)
- (22) ວັນທິຍືນຄຳຮ້ອງ (Filing Date)
- (30) ວັນທິ ບຸລິມະສິດ (Priority Date)
- (43) ວັນທິເຜີຍແຜ່ (Publication Date)
- (51) ໝວດ (International Patent Classification)
- (54) ຫົວຂໍ້ການປະດິດ (Title)
- (57) ບົດຄັດຫຍໍ້ (Abstract)
- (71) ຊື່ ແລະ ທີ່ຢູ່ ເຈົ້າຂອງສິດທິບັດ ແລະ ອະນຸສິດທິບັດ (Owner Name and Address)
- (72) ຊື່ຜູ້ປະດິດ (Inventor Name)
- (74) ຊື່ຕົວແທນ (Representative Name)
- (55) ຮູບພາບ (Pictures)

- (11) No. 698
- (21) PA 698
- (22) 17/12/2019
- (30) 2017-167236 31/08/2017 JP
- (43)
- (51) Int.Cl.G 11B 17/038(2006.01), G 11B 25/04(2006.01), G 11B 23/00(2006.01)
- (54) SPACER AND HARD DISC DRIVE DEVICE
- (57) When removing magnetic disks and spacers from a hard disk drive apparatus, as necessary, during the assembly of the hard disk drive apparatus, in order to suppress the occurrence of removal failures when removing the spacers using a gripping jig, a surface roughness Rz of an outer circumferential edge surface of a spacer is set to be at least 1.5 μm .
- (71) HOYO CORPORATION
610-1 Nish-Shinjuku, Shinjuku-ku, Tokyo 1608347, JAPAN, Japan.
- (72) Masao TAKANO.
- (74) Tilleke & Gibbins Lao Co.,Ltd.
- (55)

WO 2019/045074

FIG

[圖1]

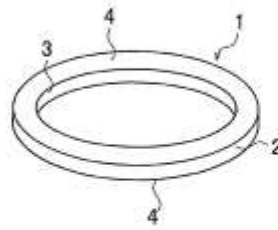

[圖2]

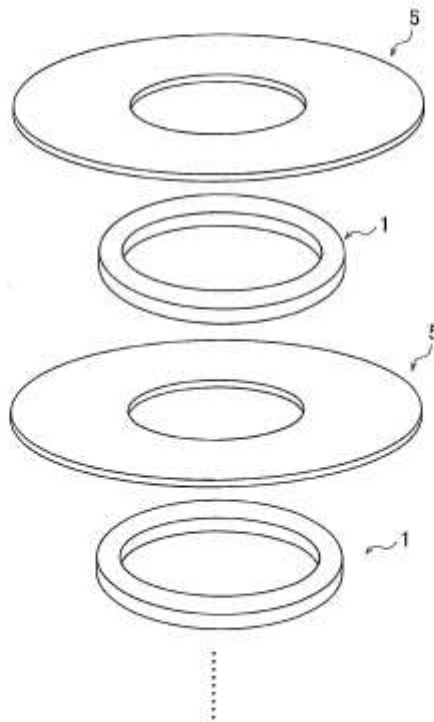

WO 2019/045074

PCT/JP2018/032488

[圖3]

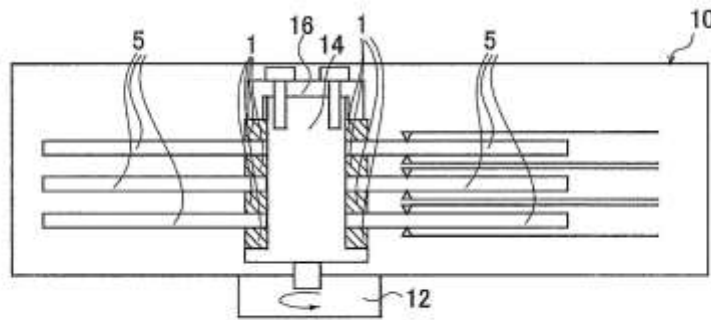

- (11) No. 737
- (21) PA 737
- (22) 12/10/2020
- (30) CN201810325528.4 06/03/2019 CN and CN201811205889.1 16/10/2018 CN
- (43)
- (51) Int.Cl. A 01H 5/10(20180101), C 12N 15/82(2006.01)
- (54) A METHOD FOR USING PLANT HETEROSIS
- (57) Provided is a method using plant hybrid vigor, comprising the following steps: S1: transforming, using gene mutations or the genetic engineering technique, the meiosis of germ cells of hybrids into mitosis-like to obtain gametes of which the genotype and the chromosome ploidy are consistent to those of hybrids; and S2: influencing, using genetic mutations and the genetic engineering technique, the participation in a process of plant gamete or embryo development, wherein the protein involved is MTL protein.
- (71) CHINA NATIONAL RICE RESEARCH INSTITUTE (CN)
No.359 Tiyuchang Rd., Xiacheng District Hangzhou, Zhejiang 310006, China.
- (72) WANG, Kejian and WANG, Chun.
- (74) ACTIP IP LIMITED [ACTIP].
- (55)



图 1A



图 1B

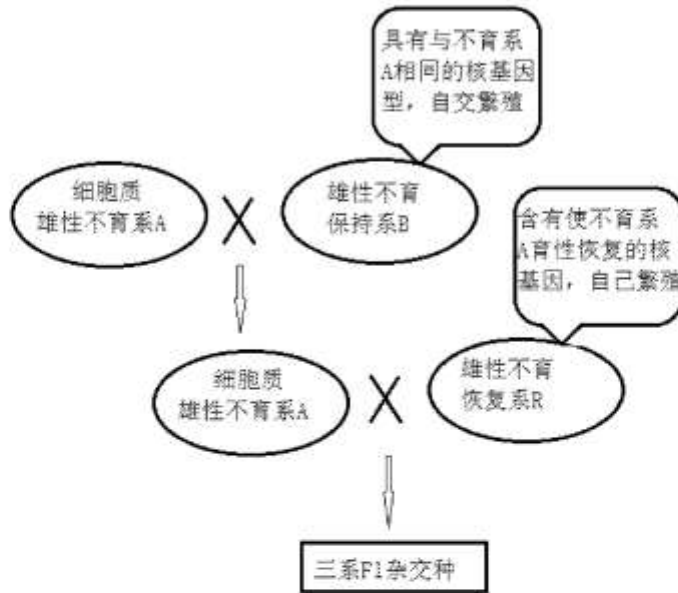

图 2

WO 2019/196576

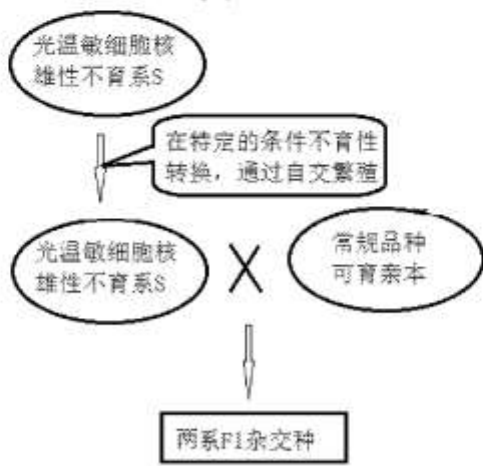
PCT/CN2019/077154

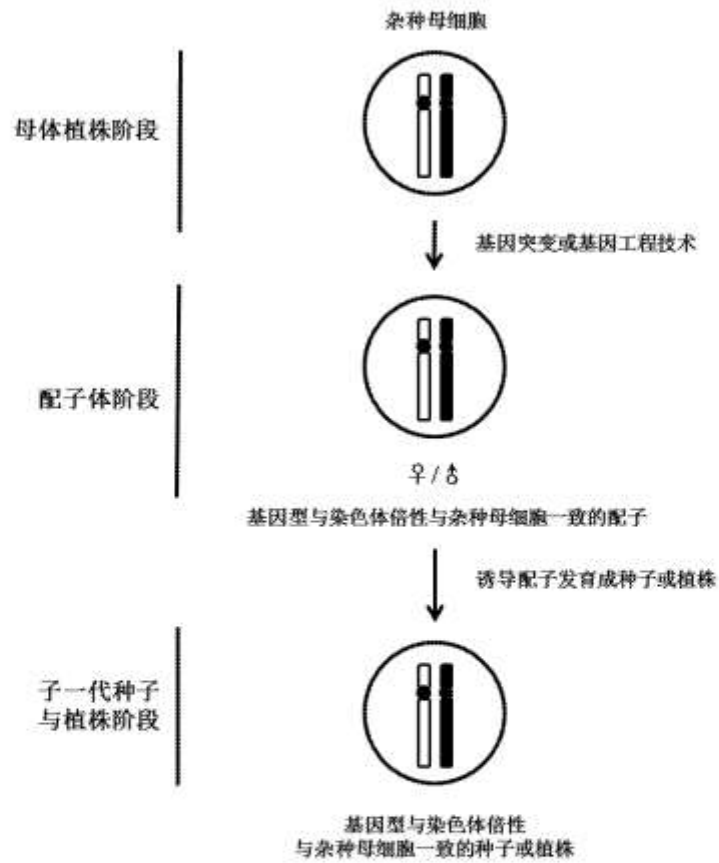

图 3



春优84

图 4A

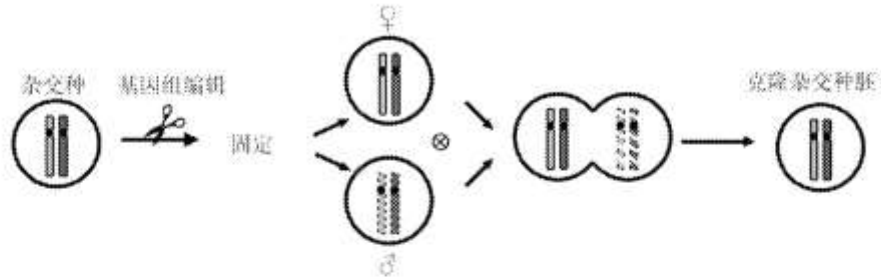
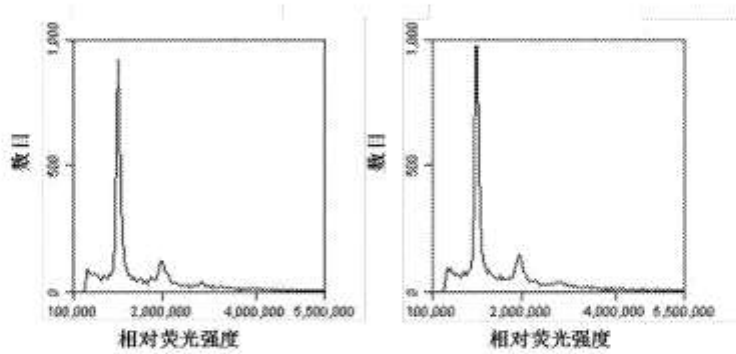
基因型和染色体倍性固定植株

图 4B

WO 2019/196576

PCT/CN2019/077154



图 5

ພາກທີ I

(Part I)

**ສິດທິບັດ ແລະ ອະນຸສິດທິບັດ
(Patent and Petty Patent)**

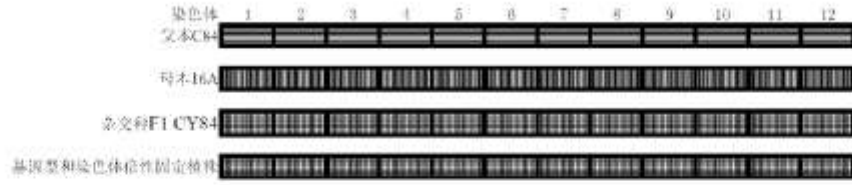
3. ການປ່ຽນແປງ

(Changes)

ພາກທີ I

(Part I)

**ສິດທິບັດ ແລະ ອະນຸສິດທິບັດ
(Patent and Petty Patent)**

4. ການດັດແກ້

(Amendments)

ພາກທີ II
(Part II)
ແບບອຸດສາຫະກຳ
(Industrial Design)

1. ຄຳຮ້ອງ
(Applications)

ຄຳອະທິບາຍກ່ຽວກັບລະຫັດຫຍໍ້
(Introduction of Codes)

- (21) ເລກທີ ຄຳຮ້ອງ (Filing Number)
- (22) ວັນທີ ຄຳຮ້ອງ (Filing Date)
- (30) ວັນທີ ບຸລິມາສິດ (Priority Date)
- (51) ໝວດ (Locarno Classification)
- (54) ຊື່ຂອງແບບອຸດສາຫະກຳ (Title)
- (71) ຊື່ ແລະ ທີ່ຢູ່ ຂອງເຈົ້າຂອງ (Owner Name and Address)
- (72) ຊື່ຜູ້ອອກແບບ (Designer Name)
- (74) ຊື່ຕົວແທນ (Representative Name)
- (55) ຮູບພາບ (Pictures)

ພາກທີ II
(Part II)
ແບບອຸດສາຫະກຳ
(Industrial Design)

2. ຜົນການຈົດທະບຽນ
(Registration)

ຄຳອະທິບາຍກ່ຽວກັບລະຫັດຫຍໍ້
(Introduction of Codes)

- (11) ເລກທີ ຈົດທະບຽນ (Registration Number)
- (15) ວັນທີ ຈົດທະບຽນ (Registration Date)
- (21) ເລກທີ ຍືນຄຳຮ້ອງ (Filing Number)
- (22) ວັນທີ ຍືນຄຳຮ້ອງ (Filing Date)
- (30) ວັນທີ ບຸລິມາສິດ (Priority Date)
- (17) ວັນທີ ໝົດອາຍຸ (Expiration Date)
- (51) ໝວດ (Locarno Classification)
- (54) ຊື່ຂອງແບບອຸດສາຫະກຳ (Title)
- (71) ຊື່ ແລະ ທີ່ຢູ່ ຂອງເຈົ້າຂອງ (Owner Name and Address)
- (72) ຊື່ຜູ້ອອກແບບ (Designer Name)
- (74) ຊື່ຕົວແທນ (Representative Name)
- (55) ຮູບພາບ (Pictures)

ພາກທີ II
(Part II)
ແບບອຸດສາຫະກຳ
(Industrial Design)

3. ການປ່ຽນແປງ
(Changes)

ພາກທີ II

(Part II)

ແບບອຸດສາຫະກຳ

(Industrial Design)

4. ການດັດແກ້

(Amendments)

ພາກທີ III
(Part III)
ເຄື່ອງໝາຍການຄ້າ
Trademarks

1. ຄໍາຮ້ອງ
(Applications)

ຄໍາອະທິບາຍກ່ຽວກັບລະຫັດຫຍໍ້
(Introduction of Codes)

- (540) ເຄື່ອງໝາຍການຄ້າ (Trademark)
- (511) ໝວດ (Nice Classification)
- (210) ເລກທີ ຄໍາຮ້ອງ (Number of the application)
- (220) ວັນທີ ຄໍາຮ້ອງ (Date of filing of the application)
- (732) ຊື່ ແລະ ທີ່ຢູ່ ຂອງຜູ້ຍື່ນຄໍາຮ້ອງ (Name and Address of applicant)

ພາກທີ III

(Part III)

ເຄື່ອງໝາຍການຄ້າ

Trademarks

2. ຜົນການຈົດທະບຽນ

(Registration)

ຄຳອະທິບາຍກ່ຽວກັບລະຫັດຫຍໍ້

(Introduction of Codes)

- (540) ເຄື່ອງໝາຍການຄ້າ (Trademark)
- (511) ໝວດ (Nice Classification)
- (210) ເລກທີ ຄຳຮ້ອງ (Number of the application)
- (220) ວັນທີ ຄຳຮ້ອງ (Date of filing of the application)
- (732) ຊື່ ແລະ ທີ່ຢູ່ ຂອງຜູ້ຍື່ນຄຳຮ້ອງ (Name and Address of applicant)
- (111) ເລກທີ ການຈົດທະບຽນເຄື່ອງໝາຍການຄ້າ (Number of the registration)
- (180) ວັນໝົດອາຍຸຂອງການຈົດທະບຽນ (Expiration date of the registration)

(540)



(511) 01

(210) No. 46773

(220) 03/03/2022

(732) BROOK FOODS (THAILAND) CO., LTD.

No. 50, Romklao Road, Klong Sam Pravet
sub-district, Lat Krabang district, Bangkok,
Thailand

(111) No. 55417

(180) 03/03/2032

(540)



(511) 29

(210) No. 46774

(220) 03/03/2022

(732) BROOK FOODS (THAILAND) CO., LTD.

No. 50, Romklao Road, Klong Sam Pravet
sub-district, Lat Krabang district, Bangkok,
Thailand

(111) No. 55418

(180) 03/03/2032

(540)



(511) 30

(210) No. 46775

(220) 03/03/2022

(732) BROOK FOODS (THAILAND) CO., LTD.
No. 50, Romklao Road, Klong Sam Pravet
sub-district, Lat Krabang district, Bangkok,
Thailand

(111) No. 55419

(180) 03/03/2032

(540)



(511) 32

(210) No. 46776

(220) 03/03/2022

(732) BROOK FOODS (THAILAND) CO., LTD.
No. 50, Romkja Road, Klong Sam Pravet
sub-district, Lat Krabang district, Bangkok,
Thailand

(111) No. 55420

(180) 03/03/2032

(540)

GENIO

(511) 09 and 42

(210) No. 46778

(220) 04/03/2022

(732) OPTEX CO., LTD.

5-8-12, Ogoto, Otsu-shi, Shiga, 520-0101,
Japan

(111) No. 55421

(180) 04/03/2032

(540)

Cassenger

(511) 09

(210) No. 46781

(220) 04/03/2022

(732) Chun Lam Group (International) Limited

8 Zhen Yuan Road, Caiwu, Wusha, Chang
An, Dongguan City, Guangdong., China

(111) No. 55422

(180) 04/03/2032

(540)



(511) 30

(210) No. 46784

(220) 04/03/2022

(732) PARIS CROISSANT CO., LTD.

18, Sagimakgol-ro 31beon-gil, Jungwon-gu,
Seongnam-si, Gyeonggi-do, Republic of
Korea

(111) No. 55423

(180) 04/03/2032

(540)



(511) 43

(210) No. 46785

(220) 04/03/2022

(732) PARIS CROISSANT CO., LTD.

18, Sagimakgol-ro 31beon-gil, Jungwon-gu,
Seongnam-si, Gyeonggi-do,
Republic of Korea

(111) No. 55424

(180) 04/03/2032

(540)



(511) 30

(210) No. 46786

(220) 04/03/2022

(732) PARIS CROISSANT CO., LTD.

18, Sagimakgol-ro 31beon-gil, Jungwon-gu,
Seongnam-si, Gyeonggi-do,
Republic of Korea

(111) No. 55425

(180) 04/03/2032

(540)



(511) 43

(210) No. 46787

(220) 04/03/2022

(732) PARIS CROISSANT CO., LTD.

18, Sagimakgol-ro 31beon-gil, Jungwon-gu,
Seongnam-si, Gyeonggi-do,
Republic of Korea

(111) No. 55426

(180) 04/03/2032

(540)

The history of Whoo

(511) 03

(210) No. 46788

(220) 07/03/2022

(732) LG HOUSEHOLD & HEALTH CARE
LTD.

58, Saemunan-ro, Jongno-gu, Seoul,
Republic of Korea

(111) No. 55427

(180) 07/03/2032

(540)

ICON

(511) 25

(210) No. 46789

(220) 09/03/2022

(732) ZHENPING COUNTY EREDIKE TRADING
CO., LTD.

NO.73, LONGYUAN COMMUNITY,
LIUQUANPU TOWNSHIP, ZHENPING
COUNTY, NANYANG CITY, HENAN
PROVINCE, CHINA

(111) No. 55428

(180) 09/03/2032

(540)

BAJAJ

(511) 07, 09, 11 and 21

(210) No. 46790

(220) 09/03/2022

(732) BAJAJ ELECTRICALS LIMITED

45/47, VEER NARIMAN ROAD, FORT,
MUMBAI-400001 INDIA

(111) No. 55429

(180) 09/03/2032

(540)

LES JOLIES

(511) 03

(210) No. 46791

(220) 09/03/2022

(732) MORAL FALCON LIMITED

FLAT/RM 901, YIP FUNG BUILDING 2-12
D' AGUILAR STREET CENTRAL,
HONG KONG

(111) No. 55430

(180) 09/03/2032

(540)

GLOW TAPE

(511) 03

(210) No. 46795

(220) 11/03/2022

(732) Tarte, Inc.

1375 Broadway, Suite 800, New York, New
York 10018, United States of America

(111) No. 55431

(180) 11/03/2032

(540)

CELEBRATIONS

(511) 30

(210) No. 46799

(220) 14/03/2022

(732) Mars, Incorporated

6885 Elm Street, Mclean, Virginia 22101,
United States of America

(111) No. 55432

(180) 14/03/2032

(540)

NOMEX

(511) 22 and 24

(210) No. 46800

(220) 14/03/2022

(732) DUPONT SAFETY & CONSTRUCTION,
INC.

974 Centre Road, Wilmington, Delaware
19805, United States Of America

(111) No. 55433

(180) 14/03/2032

(540)

TNVI

(511) 09

(210) No. 46801

(220) 14/03/2022

(732) CHANGSHA TNVI TECHNOLOGY CO.,
LTD.

BLK. J, 3RD FL., BLDG. 2, KAIYUAN
XINGE, KAIYUAN ROAD COMMUNITY,
XINGSHA STREET, CHANGSHA,
HUNAN, CHINA

(111) No. 55434

(180) 14/03/2032

(540)

PRETTYCARE

(511) 07

(210) No. 46802

(220) 15/03/2022

(732) Shenzhen Wanhai Shuntuo Technology
Co.,Ltd.

Rm 303, 3/F, Bldg 2, Yunlizhinengyuan,
No. 3, Changfa Middle Road, Yangmei
Community, Bantian Street, Longgang
District, Shenzhen, Guangdong, China

(111) No. 55435

(180) 15/03/2032

(540)

**SEAGRAM'S
COOLER**

(511) 33

(210) No. 46803

(220) 16/03/2022

(732) PERNOD RICARD USA, LLC

250 Park Avenue, 17th Floor, New York,
NY 10177, United States of America,

(111) No. 55436

(180) 16/03/2032

(540)



(511) 09

(210) No. 46804

(220) 16/03/2022

(732) Shenzhen YONGNUO Electrical
Equipment Co., Ltd.

West 2C508, Building 2, Saige Keji Yuan,
120 Zhenxing Road, Licun Community,
Huaqiang North Street, Futian District,
Shenzhen, Guangdong, China

(111) No. 55437

(180) 16/03/2032

(540)



(511) 03

(210) No. 46806

(220) 16/03/2022

(732) ZHEJIANG RIFESHOW COSMETICS
CO., LTD.

N0.67 DASID ROAD, FOTANG TOWN,
YIWU CITY, ZHEJIANG, CHINA

(111) No. 55438

(180) 16/03/2032

(540)



(511) 30

(210) No. 46807

(220) 16/03/2022

(732) CHOMPOONUICH SIRISAENGTAKSIN
101/72, MU 20, KHLONG NUENG SUB-
DISTRICT, KHLONG LUANG
DISTRICT, PATHUM THANI PROVINCE
12120 THAILAND

(111) No. 55439

(180) 16/03/2032

(540)



(511) 30

(210) No. 46808

(220) 16/03/2022

(732) CHOMPOONUICH SIRISAENGTAKSIN
101/72, MU 20, KHLONG NUENG SUB-
DISTRICT, KHLONG LUANG
DISTRICT, PATRUM TRANI PROVINCE
12120 THAILAND

(111) No. 55440

(180) 16/03/2032

(540)



(511) 43

(210) No. 46809

(220) 16/03/2022

(732) CHOMPOONUCH SIRISAENGT AKSIN
101/72, MU 20, KHLONG NUENG SUB-
DISTRICT, KHLONG LUANG
DISTRICT, PATHUM THANI PROVINCE
12120 THAILAND

(111) No. 55441

(180) 16/03/2032

(540)



(511) 30

(210) No. 46770

(220) 02/03/2022

(732) ບໍລິສັດ ຜະລິດຕະພັນອາຫານຮຸ່ງເຮືອງວຽງຈັນ
ບ້ານໜອງປາໃນ, ເມືອງສີໂຄດຕະບອງ,
ນະຄອນຫຼວງວຽງຈັນ, ສປປ ລາວ

(111) No. 55442

(180) 02/03/2032

(540)



(511) 35

(210) No. 46771

(220) 02/03/2022

(732) ບໍລິສັດ ເຄ ອອລ ເອັມ ຂາເຂົ້າ-ຂາອອກ ຈຳກັດຜູ້ດຽວ
ຖະໜົນ ເຕ 2, ບ້ານ ອຸບມຸງ, ເມືອງ ສີໂຄດຕະບອງ,
ນະຄອນຫຼວງວຽງຈັນ, ສປປ ລາວ

(111) No. 55443

(180) 02/03/2032

(540)



(511) 35

(210) No. 46772

(220) 02/03/2022

(732) ບໍລິສັດ ເຄ ແອວດີ ຄອມພິວເຕີ ຈຳກັດ
ຖະໜົນ ດົງປາລານ, ບ້ານໜອງຈັນ,
ເມືອງສີສັດຕະນາກ, ນະຄອນຫຼວງວຽງຈັນ, ສປປ ລາວ

(111) No. 55444

(180) 02/03/2032

(540)



(511) 03

(210) No. 46777

(220) 03/03/2022

(732) ບໍລິສັດ ແອງເຈື້ອ ແອ່ງນິຄຸມ ຂາເຂົ້າ-ຂາອອກ

ຈຳກັດຜູ້ດຽວ (ທ່ານ ແອ່ງເຈື້ອ ແອ່ງນິຄຸມ)

ບ້ານ ໜອງບົວ, ເມືອງສິງ, ແຂວງຫຼວງນໍ້າທາ,

ສປປ ລາວ

(111) No. 55445

(180) 03/03/2032

ພາກທີ III
(Part III)
ເຄື່ອງໝາຍການຄ້າ
Trademarks

3. ການຕໍ່ອາຍຸ
(Renewal)

ຄຳອະທິບາຍກ່ຽວກັບລະຫັດຫຍໍ້
(Introduction of Codes)

- (540) ເຄື່ອງໝາຍການຄ້າ (Trademark)
- (511) ໝວດ (Nice Classification)
- (210) ເລກທີ ຄຳຮ້ອງ (Number of the application)
- (220) ວັນທີ ຄຳຮ້ອງ (Date of filing of the application)
- (732) ຊື່ ແລະ ທີ່ຢູ່ ຂອງຜູ້ຍື່ນຄຳຮ້ອງ (Name and Address of applicant)
- (111) ເລກທີການຈັດທະບຽນເຄື່ອງໝາຍການຄ້າ (Number of the registration)
- (180) ການຕໍ່ອາຍຸການຈັດທະບຽນ (Expiration date of the renewal)

ພາກທີ III

(Part III)

ເຄື່ອງໝາຍການຄ້າ

Trademarks

4. ການປ່ຽນແປງ

(Changes)

ພາກທີ III
(Part III)
ເຄື່ອງໝາຍການຄ້າ
Trademarks

5. ການດັດແກ້
(Amendments)

ພາກທີ IV

(Part IV)

ເຄື່ອງໝາຍການຄ້າຜ່ານລະບົບມາດຣິດ

Trademarks via Madrid Protocol

1. ຄໍາຮ້ອງ

(Applications)

ຄໍາອະທິບາຍກ່ຽວກັບລະຫັດຫຍໍ້ (Introduction of Codes)

- (540) ເຄື່ອງໝາຍການຄ້າ (Trademark)
- (511) ໝວດ (Nice Classification)
- (210) ເລກທີ ຄໍາຮ້ອງ (Number of the application)
- (220) ວັນທີ ຄໍາຮ້ອງ (Date of filing of the application)
- (732) ຊື່ ແລະ ທີ່ຢູ່ ຂອງຜູ້ຍື່ນຄໍາຮ້ອງ (Name and Address of applicant)

(540)

SeaCell

(511) 17, 22, 23, 24 and 25

(210) No. M/0747061

(220) 22/09/2022

(732) smartfiber AG

Breitscheidstr. 154 07407 Rudolstadt, Germany

(540)

MEMO

(511) 03, 14 and 25

(210) No. M/0927327

(220) 20/06/2022

(732) Memo International SA

Rue du Lac 12 CH-1207 Genève, Switzerland

(540)

TOSTEM

(511) 06 and 19

(210) No. M/0988678

(220) 29/09/2022

(732) LIXIL Corporation

2-1-1 Ojima, Koto-ku Tokyo 136-8535, Japan

(540)

THOMSON

(511) 07, 08, 09, 10 and 11

(210) No. M/1235015

(220) 04/10/2022

(732) Talisman Brands, Inc.

1013 Centre Road Suite 403-B Wilmington
DE 19805, United States of America

(540)

Impact Partners

(511) 36

(210) No. M/1237685

(220) 05/10/2022

(732) Impact Partners

22 rue de la Pépinière F-75008 PARIS, France

(540)

宏运杰

(511) 06

(210) No. M/1691650

(220) 13/09/2022

(732) Hebei Yonghongyuan Technology Co., Ltd.

No. 88, Middle Chemical Road, Qiutou

Town, Shijiazhuang Circular Chemical

Industry Park Hebei Province, China

(540)

东鹏饮料

(511) 32

(210) No. M/1691659

(220) 24/08/2022

(732) Eastroc Beverage Group Co., Ltd.

1st Floor, Block 3, Zhong Guan Honghualing
Industrial West Zone, No. 142 Zhuguang
North Road, Taoyuan Street, Nanshan
District, Shenzhen Guangdong Province,
China

(540)

GOKIA

(511) 25

(210) No. M/1691705

(220) 08/08/2022

(732) Jiangsu Weite Electronic Commerce Co., Ltd

No. 77, Cherry Garden Road, Economic and
Technological Development Zone, Huaian
District, Huaian City 213002 Jiangsu
Province, China

(540)

CLARIS GO

(511) 09

(210) No. M/1691758

(220) 26/09/2022

(732) Claris International Inc.

One Apple Park Way Cupertino CA 95014,
United States of America

(540)

GREFORCE

(511) 12

(210) No. M/1691831

(220) 16/08/2022

(732) SHANDONG KAIXUAN RUBBER CO.,
LTD.

North of Yalujiang Road & East of
Wutaishan Road, Caoxian Economic
Development Zone, Heze City 274000
Shandong, China

(540)

Rhynormloc

(511) 05

(210) No. M/1691845

(220) 05/09/2022

(732) Shijiazhuang Yiling Pharmaceutical Co., Ltd.
238, Tianshan Street, Hi-Tech Area,
Shijiazhuang 100022 Hebei Province, China

(540)

BIONTECH

(511) 01, 05, 09, 10, 35, 42 and 44

(210) No. M/1691876

(220) 28/12/2021

(732) BioNTech SE

An der Goldgrube 12 55131 Mainz, Germany

(540)

DEEMAX

(511) 12

(210) No. M/1691983

(220) 16/08/2022

(732) Weifang Yuelong Rubber Co., Ltd.

Hetou Village, Taitou Town, Shouguang City
261000 Shandong, China

(540)

BOOK OF REALM
JUNGLES

(511) 09, 28 and 41

(210) No. M/1692015

(220) 16/06/2022

(732) Euro Games Technology Ltd.

"Maritsa" Str. 4, "Vranya-Lozen-Triugulnika"
BG-1151 Sofia, Bulgaria

(540)

EVNIA

(511) 09 and 20

(210) No. M/1692042

(220) 05/10/2022

(732) MMD-Monitors & Displays Nederland B.V.

Prins Bernhardplein 200 NL-1097 JB

Amsterdam, Netherlands

(540)

Coraidloc

(511) 05

(210) No. M/1692116

(220) 24/08/2022

(732) Shijiazhuang Yiling Pharmaceutical Co., Ltd.

238, Tianshan Street, Hi-Tech Area,

Shijiazhuang 100022 Hebei Province, China

(540)

Shilla Monogram

(511) 09, 35 and 43

(210) No. M/1692152

(220) 08/09/2022

(732) Hotel Shilla Co., LTD.

249, Dongho-ro, Jung-gu Seoul 04605,
Republic of Korea

(540)

POKÉTOON

(511) 09, 28 and 41

(210) No. M/1692186

(220) 26/08/2022

(732) Nintendo Co., Ltd.; GAME FREAK inc. and
Creatures Inc.

11-1, Hokotate-cho, Kamitoba, Minami-ku,
Kyoto-shi Kyoto 601-8501, Japan; 7F
KANDA SQUARE, 2-2-1 Kanda-Nishikicho,
Chiyoda-ku Tokyo 101-0054, Japan and
Iidabashi Grand Bloom 23F, 2-10-2 Fujimi,
Chiyoda-ku Tokyo 102-0071, Japan

(540)



(511) 18, 25 and 26

(210) No. M/1692224

(220) 08/07/2022

(732) CLERMON ET ASSOCIES

83 rue de Tocqueville F-75017 Paris, France

(540)



(511) 12

(210) No. M/1692317

(220) 05/08/2022

(732) PRINX CHENGSHAN (SHANDONG) TIRE
COMPANY LTD.

NO.98 NANSHAN ROAD NORTH,
RONGCHENG CITY 264300 SHANDONG
PROVINCE, CHINA

(540)

**ERNEST
RAPENEAU**

(511) 33

(210) No. M/1692350

(220) 16/09/2022

(732) CHAMPAGNE G.H. MARTEL ET CIE

69 avenue de Champagne F-51200

EPERNAY, France

(540)

冀石鼎
jishiding

(511) 06

(210) No. M/1692362

(220) 15/06/2022

(732) Shijiazhuang Shuangcheng Aluminum

Co.,Ltd.

Luandou Road, Luancheng District,

Shijiazhuang City Hebei Province, China

(540)



(511) 05 and 10

(210) No. M/1692369

(220) 05/08/2022

(732) HANGZHOU TONGZHOU

BIOTECHNOLOGY CO., LTD.

ROOM 102, 1ST FLOOR, BUILDING 4,

NO. 191, XINTIAN ROAD, YUNHE

STREET, LINPING DISTRICT,

HANGZHOU CITY 310018 ZHEJIANG

PROVINCE, CHINA

(540)



(511) 30

(210) No. M/1692375

(220) 09/08/2022

(732) FERRERO S.P.A.

PIAZZALE PIETRO FERRERO 1 I-12051

ALBA, CUNEO, ITALY

(540)



(511) 09, 28 and 41

(210) No. M/1692494

(220) 16/06/2022

(732) Euro Games Technology Ltd.

“Maritsa” Str. 4, “Vranya-Lozen-Triugulnika”
BG-1151 Sofia, Bulgaria

(540)



(511) 32

(210) No. M/1692506

(220) 24/08/2022

(732) Eastroc Beverage Group Co., Ltd.

1st Floor, Block 3, Zhong Guan Honghualing
Industrial West Zone, No. 142 Zhuguang
North Road, Taoyuan Street, Nanshan
District, Shenzhen Guangdong Province,
China

(540)

TEANAGOO

(511) 30

(210) No. M/1692509

(220) 29/09/2022

(732) DEHUA TIGOO CERAMIC CO., LTD.

No. 179 Lingnan Road, Baomei Industrial
District, Longxun Town, Dehua County,
Quanzhou City Fujian Province, China

(540)

EVNIA

(511) 09 and 20

(210) No. M/1692584

(220) 05/10/2022

(732) MMD-Monitors & Displays Nederland B.V.

Prins Bernhardplein 200 NL-1097 JB
Amsterdam, Netherlands

(540)

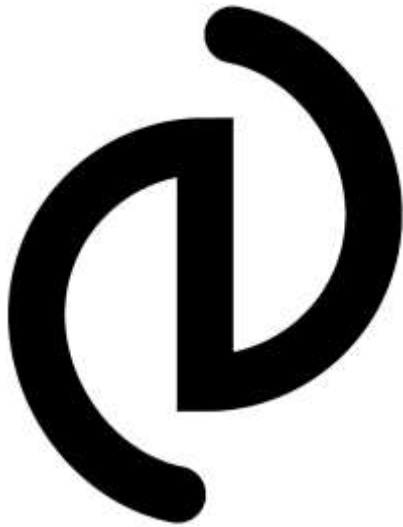

(511) 09 and 20

(210) No. M/1692617

(220) 05/10/2022

(732) MMD-Monitors & Displays Nederland B.V.

Prins Bernhardplein 200 NL-1097 JB

Amsterdam, Netherlands

ພາກທີ IV

(Part IV)

ເຄື່ອງໝາຍການຄ້າຜ່ານລະບົບມາດຣິດ

Trademarks via Madrid Protocol

2. ຜົນການຈົດທະບຽນ

(Registration)

ຄຳອະທິບາຍກ່ຽວກັບລະຫັດຫຍໍ້

(Introduction of Codes)

- (540) ເຄື່ອງໝາຍການຄ້າ (Trademark)
- (511) ໝວດ (Nice Classification)
- (210) ເລກທີ ຄຳຮ້ອງ (Number of the application)
- (220) ວັນທີ ຍື່ນຄຳຮ້ອງ (Date of filing of the application)
- (732) ຊື່ ແລະ ທີ່ຢູ່ ຂອງຜູ້ຍື່ນຄຳຮ້ອງ (Name and Address of applicant)
- (111) ເລກທີການຈົດທະບຽນເຄື່ອງໝາຍການຄ້າ (Number of the registration)
- (180) ວັນໝົດອາຍຸຂອງການຈົດທະບຽນ (Expiration date of the registration)

(540)

LÖWENBRÄU

(511) 32

(210) No. M/0168974

(220) 21/01/2022

(732) LÖWENBRÄU AG

Nymphenburger Strasse 7 80335

MÜNCHEN, Germany

(111) No. M/0168974

(180) 30/05/2023

(540)

PENNOL

(511) 01, 03 and 04

(210) No. M/0599765

(220) 08/02/2022

(732) WOLF OIL CORPORATION N.V.

Georges Gilliotstraat 52 B-2620 Hemiksem,

Belgium

(111) No. M/0599765

(180) 15/03/2023

(540)

NEWAY

(511) 06

(210) No. M/0706282

(220) 24/01/2022

(732) Neway Valve (Suzhou) Co., Ltd.

No. 999 Xiangjiang Road, Suzhou New
District, Suzhou Jiangsu, China

(111) No. M/0706282

(180) 05/01/2029

(540)

NUDIE

(511) 18 and 25

(210) No. M/0840632

(220) 07/02/2022

(732) Nudie Jeans Co AB

Södra Larmgatan 14 Göteborg SE-411 16,
Sweden

(111) No. M/0840632

(180) 01/10/2024

(540)

Sunny Central

(511) 09

(210) No. M/0870806

(220) 02/02/2022

(732) SMA Solar Technology AG

Sonnenallee 1 34266 Niestetal, Germany

(111) No. M/0870806

(180) 03/11/2025

(540)

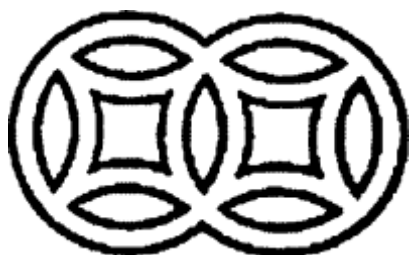

(511) 12

(210) No. M/0908085

(220) 27/01/2022

(732) DOUBLE COIN TYRE GROUP LTD.

No. 2613 Jian Chuan Road SHANGHAI,

China

(111) No. M/0908085

(180) 08/10/2026

(540)

PHARMA LINE

(511) 03

(210) No. M/1468379

(220) 09/02/2022

(732) Juan Antonio Canovas Canovas

Calle Segre, 32 (Pol Industiral Plá d'en Coll)

E-08110 Montcada i Reixac (Barcelona),

Spain

(111) No. M/1468379

(180) 29/03/2029

(540)



(511) 03

(210) No. M/1475501

(220) 09/02/2022

(732) JUAN ANTONIO CÁNOVAS CÁNOVAS

C. Segre, 32. Pol. Ind. Pla d'en Coll E-08110

MONTCADA I REIXAC, SPAIN

(111) No. M/1475501

(180) 20/05/2029

(540)

HUAWEI RTOS

(511) 09 and 42

(210) No. M/1489217

(220) 24/01/2022

(732) HUAWEI TECHNOLOGIES CO., LTD.

Administration Building Huawei

Technologies Co., Ltd., Bantian, Longgang

District Shenzhen, China

(111) No. M/1489217

(180) 01/07/2029

(540)

诗尼曼

(511) 20

(210) No. M/1500990

(220) 19/01/2022

(732) Guangzhou Snimay Furniture Co., Ltd

Fulian Road (main factories and office

buildings), Lianwei Village, Lotus Mountain,

Shilou Town, Panyu District, Guangzhou

511440 Guangdong Province, China

(111) No. M/1500990

(180) 09/09/2029

(540)



(511) 10

(210) No. M/1542164

(220) 24/01/2022

(732) Anhui Deep Blue Medical Technology Co.,
Ltd.

1#, D Zone, Four Floor, Pearl Industrial Park,
106 Innovation Avenue, Hefei Hi-tech
Development Zone 100031 Anhui, China

(111) No. M/1542164

(180) 09/05/2030

(540)



(511) 33

(210) No. M/1543793

(220) 24/01/2022

(732) LES DOMAINES BARONS DE
ROTHSCHILD (LAFITE)

40-50 COURS DU MÉDOC F-33300
BORDEAUX, FRANCE

(111) No. M/1543793

(180) 23/06/2030

(540)



(511) 09

(210) No. M/1593615

(220) 24/01/2022

(732) Beijing Jingheng Tengwei Kejian Trade
Co.,Ltd.

Room 306, Third Floor, 28-09 Nanhuan
Road, Chengbei Street, Changping District
102200 Beijing, China

(111) No. M/1593615

(180) 02/03/2031

(540)



(511) 09

(210) No. M/1599936

(220) 27/01/2022

(732) Jingheng Tengwei (Huizhou) Electronic
Technology Co.,Ltd

Dahetian, Shangnan Village, Yuanzhou
Town, Boluo County, Huizhou City 516123
Guangdong Province, China

(111) No. M/1599936

(180) 06/05/2031

(540)



(511) 03

(210) No. M/1604588

(220) 23/01/2022

(732) ZHEJIANG JINGHUI COSMETICS SHARE
CO., LTD.

NO.8 Anshang Road, Niansanli Street, Yiwu
City 322000 Zhejiang, China

(111) No. M/1604588

(180) 01/07/2031

(540)

V.V.LOVE



(511) 03

(210) No. M/1626283

(220) 23/01/2022

(732) ZHEJIANG JINGHUI COSMETICS SHARE
CO., LTD.

NO.8 Anshang Road, Niansanli Street, Yiwu
City 322000 Zhejiang, China

(111) No. M/1626283

(180) 02/07/2031

(540)

DETRANS

(511) 05

(210) No. M/0436156

(220) 07/12/2021

(732) SUMITOMO CHEMICAL COMPANY,
LIMITED

2-7-1, Nihonbashi, Chuo-ku Tokyo 103-
6020, Japan

(111) No. M/0436156

(180) 10/03/2028

(540)

BACK NUMBER

(511) 18, 25 and 26

(210) No. M/0857551

(220) 24/12/2021

(732) RIGHT-ON CO., LTD.

11-1, Azuma 1-chome, Tsukuba-shi Ibaraki-
ken 305-8503, Japan

(111) No. M/0857551

(180) 20/01/2025

(540)

Salt and Pepper

(511) 25

(210) No. M/0950445

(220) 24/12/2021

(732) RIGHT-ON CO., LTD.

11-1, Azuma 1-chome, Tsukuba-shi Ibaraki-
ken 305-8503, Japan

(111) No. M/0950445

(180) 02/05/2027

(540)



nor sken

(511) 03 and 05

(210) No. M/1573763

(220) 13/01/2022

(732) AKSCCELL PTE. LTD.

50 RAFFLES PLACE, SINGAPORE LAND
TOWER #37-00 048623, Singapore

(111) No. M/1573763

(180) 15/12/2030

(540)



(511) 12

(210) No. M/1642766

(220) 13/12/2021

(732) Ningbo Kaabo Technology CO., LTD

4th Floor, No. 1 Building, 885 Chunhua

Road, Wangchun Industrial Park, Haishu

District, Ningbo Zhejiang, China

(111) No. M/1642766

(180) 13/12/2031

(540)

ANTA I SOLAR

(511) 06

(210) No. M/1642969

(220) 10/01/2022

(732) ANTAI TECHNOLOGY CO.,LTD

Guanshan industrial park, Wu'an Town,

Changtai county, Zhangzhou Fujian Province,

China

(111) No. M/1642969

(180) 10/01/2032

(540)

The logo for MEGAONE, featuring the word "MEGAONE" in a bold, black, sans-serif font. The letters "ONE" are enclosed in a white rectangular box with a black border.

(511) 34

(210) No. M/1643012

(220) 08/12/2021

(732) SHENZHEN IVPS TECHNOLOGY CO.,
LTD.

201, Building 76, Liantang Industrial Zone,
Tangwei Community, Fenghuang Street,
Guangming District, Shenzhen 518132
Guangdong, China

(111) No. M/1643012

(180) 08/12/2031

(540)

The logo for Techderm, featuring the word "Techderm" in a grey, sans-serif font. The letter "d" is stylized with a vertical line through it.

(511) 10

(210) No. M/1643817

(220) 14/12/2021

(732) Hangzhou Techderm Biological Products
Co.,Ltd

Floor 2, East Building 6, No. 88 Jiangling
Road, Binjiang District, Hangzhou Zhejiang
Province, China

(111) No. M/1643817

(180) 14/12/2031

(540)

Hilde

(511) 11

(210) No. M/1643907

(220) 28/12/2021

(732) HUPFARRI ENTERPRISE PTE. LTD.

15 UBI CRESCENT 408575, SINGAPORE

(111) No. M/1643907

(180) 28/12/2031

(540)

A N N *E* B R A

(511) 25

(210) No. M/1644187

(220) 13/12/2021

(732) Wavily Co., Ltd.

131 Naranong Road, Klongtoey 10110

Klongtoey, Bangkok, Thailand

(111) No. M/1644187

(180) 13/12/2031

(540)



(511) 12 and 37

(210) No. M/1644590

(220) 15/12/2021

(732) Chery Automobile Co., Ltd.

8 Changchun Road, Economy & Technology
Development Zone, Wuhu City 241009
Anhui Province, China

(111) No. M/1644590

(180) 15/12/2031

(540)

**WRANGLER
ANGLER**

(511) 25

(210) No. M/1645164

(220) 22/12/2021

(732) Wrangler Apparel Corp.

3411 Silverside Road Wilmington DE 19810,
United States of America

(111) No. M/1645164

(180) 22/12/2031

(540)



(511) 05

(210) No. M/1645316

(220) 06/12/2021

(732) Zhejiang Hongyu Medical Commodity Co.
LTD

No. 668, Chanhua Road, Industrial Functional
Zone, Fotang Town, Yiwu city Zhejiang
Province, China

(111) No. M/1645316

(180) 06/12/2031

(540)



(511) 44

(210) No. M/1645319

(220) 04/01/2022

(732) University of Miami

1320 S. Dixie Highway, Suite 1250 Coral
Gables FL 33146, United States of America

(111) No. M/1645319

(180) 04/01/2032

(540)



(511) 37

(210) No. M/1645337

(220) 09/12/2021

(732) China State Construction Engineering Corporation Ltd.

No. 15 Sanlihe Road, Haidian District
Beijing, China

(111) No. M/1645337

(180) 09/12/2031

(540)



(511) 21, 30, 35 and 43

(210) No. M/1645747

(220) 07/12/2021

(732) BAMA TEA Stock Limited Company

7th Floor, Hua Du Yuan Building, Dongmen
South Road, Nanhu Street, Luohu District,
Shenzhen Guangdong, China

(111) No. M/1645747

(180) 07/12/2031

(540)

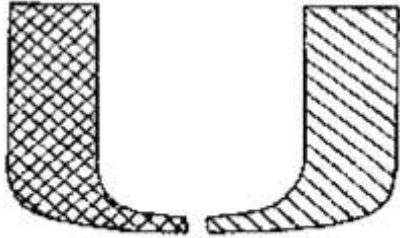

(511) 25

(210) No. M/1645758

(220) 04/01/2022

(732) University of Miami

1320 S. Dixie Highway, Suite 1250 Coral

Gables FL 33146, United States of America

(111) No. M/1645758

(180) 04/01/2032

(540)



(511) 05

(210) No. M/1646005

(220) 15/12/2021

(732) DAEWOONG CO., LTD.

244, Galmachi-ro, Jungwon-gu Seongnam-si

Gyeonggi-do, Republic of Korea

(111) No. M/1646005

(180) 15/12/2031

(540)

GMV

(511) 11

(210) No. M/1646664

(220) 17/12/2021

(732) GREE ELECTRIC APPLIANCES, INC. OF
ZHUHAI

JINJI WEST ROAD, QIANSHAN ZHUHAI
519070 GUANGDONG, CHINA

(111) No. M/1646664

(180) 17/12/2031

(540)



(511) 29

(210) No. M/1646673

(220) 10/12/2021

(732) Fujian Dongshan Haiyuan Aquatic Products
Co., Ltd.

#18 xinghai Rd, Wojiao, Chencheng Town,
Dongshan County, Zhangzhou City Fujian,
China

(111) No. M/1646673

(180) 10/12/2031

(540)

KOMATSU

(511) 08, 09, 14, 16, 18, 21, 24, 25 and 28

(210) No. M/1578230

(220) 16/07/2021

(732) KOMATSU LTD.

3-6, 2-chome Akasaka, Minato-ku Tokyo

107-8414, Japan

(111) No. M/1578230

(180) 11/09/2030

(540)

WEST BIKING

(511)

(210) No. M/1555081

(220) 15/09/2020

(732) Yiwu Ledong Import And Export Co., Ltd.

4F, Unit 1, Buliding 1, Zone 1, Qiaodong,

Jiangdong Street, Yiwu City 322000 Zhejiang

Province, China

(111) No. M/1555081

(180) 15/09/2030

(540)

SOF I YAL

(511) 03, 05 and 10

(210) No. M/1647215

(220) 24/09/2021

(732) Hangzhou Techderm Biological Products Co.,
Ltd.

Floor 2, East Building 6, No. 88 Jiangling
Road, Binjiang District Hangzhou, China

(111) No. M/1647215

(180) 24/09/2031

(540)

RED SHISO

(511) 03

(210) No. M/1647924

(220) 12/10/2021

(732) PT. Bina Karya Prima

Jl. Raya Bekasi Km. 27, Pejuang, Medan
Satria, Bekasi Jawa Barat, Indonesia

(111) No. M/1647924

(180) 12/10/2031

(540)

iFFALCON

(511) 07, 09 and 11

(210) No. M/1648351

(220) 22/09/2021

(732) SHENZHEN TCL NEW TECHNOLOGY
CO., LTD.

9/F, Building D4, International E City, 1001

Zhongshan Park Road, Xili Street, Nanshan

District, 518000 Shenzhen, Guangdong, China

(111) No. M/1648351

(180) 22/09/2031

(540)

Carlsberg

(511) 32 and 33

(210) No. M/1651307

(220) 02/11/2021

(732) Carlsberg A/S

J.C. Jacobsens Gade 1 DK-1799 Copenhagen

V, Denmark

(111) No. M/1651307

(180) 02/11/2031

ພາກທີ IV

(Part IV)

ເຄື່ອງໝາຍການຄ້າຜ່ານລະບົບມາດຣິດ

Trademarks via Madrid Protocol

3. ຜົນການຕໍ່ອາຍຸ

(Renewal)

ຄຳອະທິບາຍກ່ຽວກັບລະຫັດຫຍໍ້

(Introduction of Codes)

- (540) ເຄື່ອງໝາຍການຄ້າ (Trademark)
- (511) ໝວດ (Nice Classification)
- (210) ເລກທີ ຄຳຮ້ອງ (Number of the application)
- (220) ວັນທີ ຍື່ນຄຳຮ້ອງ (Date of filing of the application)
- (732) ຊື່ ແລະ ທີ່ຢູ່ ຂອງຜູ້ຍື່ນຄຳຮ້ອງ (Name and Address of applicant)
- (111) ເລກທີການຈົດທະບຽນເຄື່ອງໝາຍການຄ້າ (Number of the registration)
- (180) ການຕໍ່ອາຍຸຂອງການຈົດທະບຽນ (Expiration date of the renewal)

(540) Renewal



(511) 34

(210) No. 414

(220) 17/03/1992

(732) ANHEUSER-BUSCH, LLC*

One Busch Place, St. Louis, Mo 63118,
United States of America

(111) No. 120

(180) 17/03/2032

(540) Renewal

VAN HOUTEN

(511) 30

(210) No. 787

(220) 27/04/1992

(732) BARRY CALLEBAUT AG.

Hardturmstrasse 181, 8005 Zurich, Switzerland

(111) No. 765

(180) 27/04/2032

(540) Renewal

I B M

(511) 09, 16, 35, 37, 41 and 42

(210) No. 1138

(220) 04/08/1992

(732) International Business Machines Corporation

1 New Orchard Road, Armonk, New York

10504, United States of America

(111) No. 1087

(180) 04/08/2062

(540) Renewal

I B M

(511) 09, 16, 35, 37, 41 and 42

(210) No. 1138

(220) 04/08/1992

(732) International Business Machines Corporation

1 New Orchard Road, Armonk, New York

10504, United States of America

(111) No. 1087

(180) 04/08/2072

(540) Renewal

I B M

(511) 09, 16, 35, 37, 41 and 42

(210) No. 1138

(220) 04/08/1992

(732) International Business Machines Corporation

1 New Orchard Road, Armonk, New York

10504, United States of America

(111) No. 1087

(180) 04/08/2032

(540) Renewal

I B M

(511) 09, 16, 35, 37, 41 and 42

(210) No. 1138

(220) 04/08/1992

(732) International Business Machines Corporation

1 New Orchard Road, Armonk, New York

10504, U.S.A., United States of America

(111) No. 1087

(180) 04/08/2042

(540) Renewal

I B M

(511) 09, 16, 35, 37, 41 and 42

(210) No. 1138

(220) 04/08/1992

(732) International Business Machines Corporation

1 New Orchard Road, Armonk, New York

10504, United States of America

(111) No. 1087

(180) 04/08/2052

(540) Renewal

I B M

(511) 09, 16, 35, 37, 41 and 42

(210) No. 1138

(220) 04/08/1992

(732) International Business Machines Corporation

1 New Orchard Road, Armonk, New York

10504, United States of America

(111) No. 1087

(180) 04/08/2082

(540) Renewal

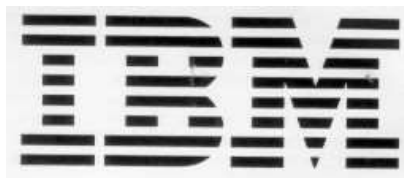

(511) 09, 16, 35, 37, 41 and 42

(210) No. 1139

(220) 05/08/1992

(732) International Business Machines Corporation

1 New Orchard Road, Armonk, New York

10504, United States of America

(111) No. 1088

(180) 05/08/2032

(540) Renewal

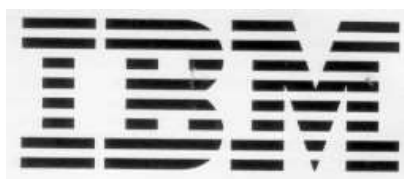

(511) 09, 16, 35, 37, 41 and 42

(210) No. 1139

(220) 05/08/1992

(732) International Business Machines Corporation

1 New Orchard Road, Armonk, New York

10504, United States Of America

(111) No. 1088

(180) 05/08/2082

(540) Renewal

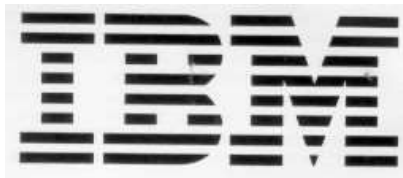

(511) 09, 16, 35, 37, 41 and 42

(210) No. 1139

(220) 05/08/1992

(732) International Business Machines Corporation

1 New Orchard Road, Armonk, New York

10504, United States of America

(111) No. 1088

(180) 05/08/2062

(540) Renewal

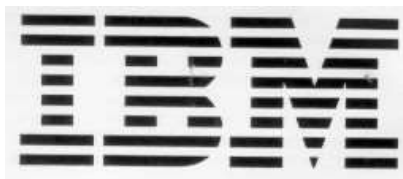

(511) 09, 16, 35, 37, 41 and 42

(210) No. 1139

(220) 05/08/1992

(732) International Business Machines Corporation

1 New Orchard Road, Armonk, New York

10504, United States Of America

(111) No. 1088

(180) 05/08/2042

(540) Renewal

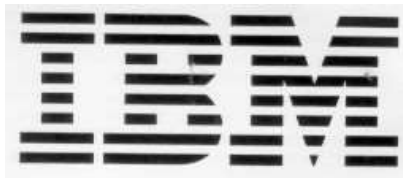

(511) 09, 16, 35, 37, 41 and 42

(210) No. 1139

(220) 05/08/1992

(732) International Business Machines Corporation

1 New Orchard Road, Armonk, New York

10504, United States Of America

(111) No. 1088

(180) 05/08/2072

(540) Renewal

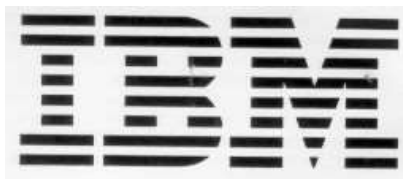

(511) 09, 16, 35, 37, 41 and 42

(210) No. 1139

(220) 05/08/1992

(732) International Business Machines Corporation

1 New Orchard Road, Armonk, New York

10504, United States Of America

(111) No. 1088

(180) 05/08/2052

(540) Renewal

GUESS

(511) 25

(210) No. 1127

(220) 27/07/1992

(732) GMESS, INC

1444 SOUTH ALAMEDA STREET LOS
ANGELES, CALIFORNIA 90021,
UNITED STATES OF AMERICA

(111) No. 1116

(180) 27/07/2032

(540) Renewal

THE PUMP

(511) 18, 25 and 28

(210) No. 1034

(220) 22/06/1992

(732) Reebok International Limited (UK)

4th Floor, 11/12 Pall Mall, London SW 1Y
5LU, The , United Kingdom

(111) No. 1117

(180) 22/06/2042

(540) Renewal

THE PUMP

(511) 18, 25 and 28

(210) No. 1034

(220) 22/06/1992

(732) REEBOX INTERNATIONAL LIMITED (UK)

4th Floor, 11/12 Pall Mall, London, SW1Y

5LU, United Kingdom

(111) No. 1117

(180) 22/06/2032

(540) Renewal

THE PUMP

(511) 18, 25 and 28

(210) No. 1034

(220) 22/06/1992

(732) Reebok International Limited (UK)

4th Floor, 11/12 Pall Mall, London SW 1Y

5LU, United Kingdom

(111) No. 1117

(180) 22/06/2052

(540) Renewal

REEBOK

(511) 18, 25 and 28

(210) No. 1035

(220) 22/06/1992

(732) Reebok International Limited

4th Floor, 11/12 Pall Mall, London SW 1Y

5LU, The, United Kingdom

(111) No. 1118

(180) 22/06/2052

(540) Renewal

REEBOK

(511) 18, 25 and 28

(210) No. 1035

(220) 22/06/1992

(732) Reebok International Limited

4th Floor, 11/12 Pall Mall, London SW 1Y

5LU, United States Of America

(111) No. 1118

(180) 22/06/2032

(540) Renewal

REEBOK

(511) 18, 25 and 28

(210) No. 1035

(220) 22/06/1992

(732) Reebok International Limited

4th Floor, 11/12 Pall Mall, London SW 1Y

5LU, The, United Kingdom

(111) No. 1118

(180) 22/06/2042

(540) Renewal



(511) 30

(210) No. 1411

(220) 01/10/1992

(732) Wm. Wrigley Jr. Company.

1132 West Blackhawk Street, Chicago,

Illinois 60642, United States Of America

(111) No. 1259

(180) 01/10/2032

(540) Renewal



(511) 32

(210) No. 1441

(220) 01/10/1992

(732) ST. PAULI BRAUEREI C.L. WILH.

BRANDT GMBH

Am Deich 18/19, 28199 Bremen, Germany

(111) No. 1290

(180) 01/10/2032

(540) Renewal

PENNER

(511) 07

(210) No. 1398

(220) 25/09/1992

(732) J.H. Fenner & Co. Limited

Campbell Road Stoke-on-Trent, Staffordshire,

England, ST4 4EY, United Kingdom

(111) No. 1526

(180) 25/09/2032

(540) Renewal

LANCÔME

(511) 03, 05 and 21

(210) No. 1399

(220) 25/09/1992

(732) L'OREAL

14 Rue Royale, 75008 Paris, France, France

(111) No. 1527

(180) 25/09/2032

(540) Renewal

SHISEIDO

(511) 03

(210) No. 1667

(220) 18/11/1992

(732) SHISEIDO COMPANY LIMITED

7-5-5 GINZA, CHUO-KU, TOKYO, 104-
0061, Japan

(111) No. 1795

(180) 18/11/2032

(540) Renewal

BUDGET

(511) 39

(210) No. 8984

(220) 20/12/2001

(732) BUDGET RENT A CAR SYSTEM, INC.

6 Sylvan Way, Parsippany, New Jersey 07054,

United States Of America

(111) No. 8696

(180) 20/12/2031

(540) Renewal

GALVALUME

(511) 06

(210) No. 9003

(220) 25/12/2001

(732) BIEC International Inc.

5100 NW 140th Street Vancouver, WA,

98685, United States Of America

(111) No. 8710

(180) 25/12/2031

(540) Renewal

CRUSET

(511) 03

(210) No. 9331

(220) 29/04/2002

(732) THAI-MEKO CO., LTD.

122/3 MOO 7, SOI Thakarm, Rama 2 Rd.,
Samaedam, Bangkhuntien 10150, Thailand

(111) No. 8860

(180) 29/04/2032

(540) Renewal

**MARLBORO
CLASSICS**

(511) 18

(210) No. 9453

(220) 10/06/2002

(732) Philip Morris Global Brands Inc.

9711 Farrar Court, Richmond, Virginia
23236, United States Of America

(111) No. 8983

(180) 01/11/2042

(540) Renewal

**MARLBORO
CLASSICS**

(511) 25

(210) No. 9454

(220) 10/06/2002

(732) Philip Morris Global Brands Inc.

9711 Farrar Court, Richmond, Virginia

23236, United States Of America

(111) No. 8984

(180) 01/11/2042

(540) Renewal

**CONSIDER IT
SOLVED**

(511) 41

(210) No. 9475

(220) 19/06/2002

(732) EMERSON ELECTRIC CO.,

, 8000 West florrisant Avenue, St., Louis,

Missouri 63136, United States Of America

(111) No. 9005

(180) 31/10/2042

(540) Renewal

BLU-RAY DISC

(511) 09

(210) No. 9478

(220) 21/06/2002

(732) Blu-ray Disc Association

855 SW 153RD DRIVE, BEAVERTON,
OREGON 97003, United States Of America

(111) No. 9008

(180) 21/06/2032

(540) Renewal



(511) 30

(210) No. 9488

(220) 21/06/2002

(732) KUI KUI CO., LTD

, No. 48, Tong Yuan Street, Chung Li City,
Tao Yuan Country, Taiwan

(111) No. 9018

(180) 02/11/2042

(540) Renewal



(511) 30

(210) No. 9489

(220) 21/06/2002

(732) KUAI KUAI CO., LTD

, No. 48, Tong Yuan Street, Chung Li City,
Tao Yuan Country, Taiwan

(111) No. 9019

(180) 02/11/2042

(540) Renewal

DAIICHI

(511) 12

(210) No. 9508

(220) 04/07/2002

(732) Innovatia Co., Ltd and Thai Motor Chain Co.
Ltd

12/166-167 Moo7, Lumlookka Road, ladsawai,
Lumlookka, Patumtanee 12150, Thailand and
7/138 Moo 4, Amata City Industrial Estate,
Mabyangporn, Pluakdaeng, Reyong 21140,
Thailand

(111) No. 9037

(180) 04/07/2032

(540) Renewal

DAI

(511)

(210) No. 9509

(220) 04/07/2002

(732) Thai Motor Chain Co., Ltd.

7/138 Moo 4, Amata City Industrial Estate,
Mabyangporn, Pluakdaeng, Rayong 21140, ,
Thailand

(111) No. 9038

(180) 04/07/2032

(540) Renewal



(511) 09

(210) No. 9607

(220) 13/08/2002

(732) GMM Grammy Public Company Limited

50 GMM Grammy Place, Sukhmvit 21 Road
(Asoke) Khlongtoeinuea, Wattana, Bangkok
10110, Thailand

(111) No. 9134

(180) 13/08/2032

(540) Renewal



(511) 41

(210) No. 9608

(220) 13/08/2002

(732) GMM Grammy Public Company Limited
50 GMM Grammy Place, Sukhumvit 21 Road
(Asoke) Khlongtoeinuea, Wattana, Bangkok
10110, Thailand

(111) No. 9135

(180) 04/11/2042

(540) Renewal



(511) 42

(210) No. 9609

(220) 13/08/2002

(732) GMM Grammy Public Company Limited
50 GMM Grammy Place, Sukhumvit 21 Road
(Asoke) Khlongtoeinuea, Bangkok 10110,
Thailand

(111) No. 9136

(180) 04/11/2042

(540) Renewal



(511) 42

(210) No. 9616

(220) 16/08/2002

(732) Consulting and Research Company for
Technology Transfer and Investment (
CONCETTI)

5th Floor, 38 Ba trieu Street, Hang Bai Ward,
Hoan Kiem District, Hanoi City, Vietnam

(111) No. 9143

(180) 16/08/2032

(540) Renewal



(511) 21

(210) No. 9701

(220) 30/09/2002

(732) DUY TAN PLASTICS MANUFACTURING
CORPORATION

298 Ho Hoc Lam, An Lac Ward, Binh Tan
District, Hochiminh City, Vietnam

(111) No. 9230

(180) 31/10/2042

(540) Renewal

LACTA

(511) 29

(210) No. 9702

(220) 30/09/2002

(732) Viriyapattana Company Limited

3534 Sukhumvit Road, Kwang Bangna Tai,

Khet Bangna, Bangkok 10260, Thailand

(111) No. 9231

(180) 31/10/2042

(540) Renewal

MENTOS

(511) 30

(210) No. 9737

(220) 30/10/2002

(732) FERFETTI VAN MELLE BENELUX B.V

Zoete Inval 20, 4815 HK Breda, Netherlands

(111) No. 9263

(180) 04/11/2042

(540) Renewal



(511) 29

(210) No. 9738

(220) 30/10/2002

(732) Perfetti Van Melle Benelux B.V.

Zoete Inval 20, 4815 HK Breda, Netherlands

(111) No. 9264

(180) 04/11/2042

(540) Renewal



(511) 30

(210) No. 9744

(220) 30/10/2002

(732) Thai Fermentation Industry Co., Ltd.

503 Sriyudhaya Road, Thanon Phayathai

Sub-District, Bangkok 10400, Thailand

(111) No. 9270

(180) 31/10/2042

(540) Renewal

TECASAFE

(511) 09

(210) No. 25726

(220) 02/02/2012

(732) Ten Cate Protect B.V.

Campbellweg 30, 7443 PV Nijverdal,
Netherlands

(111) No. 25061

(180) 02/02/2032

(540) Renewal

TECASAFE

(511) 24

(210) No. 25727

(220) 02/02/2012

(732) TEN CATE PROTECT B.V.

CAMPBELLWEG 30, 7443 PV NIJVERDAL,
THE NETHERLANDS

(111) No. 25062

(180) 02/02/2032

(540) Renewal

The logo for Olivoilà features the brand name in a bold, black, serif font. The 'i' in 'voilà' has a distinctive dot that resembles a leaf or a drop.

(511) 29

(210) No. 26206

(220) 18/04/2012

(732) WILMAR INTERNATIONAL LIMITED

56 Neil Road, 088830, Singapore

(111) No. 25507

(180) 09/10/2032

(540) Renewal



(511) 34

(210) No. 26238

(220) 23/04/2012

(732) WHY NOT (B.V.I.) CO., LIMITED

P.O. BOX 957, OFFSHORE

INCORPORATIONS CENTRE, ROAD

TOWN, TORTOLA, UNITED KINGDOM

(111) No. 25523

(180) 09/10/2032

(540) Renewal

BELLATOR

(511) 41

(210) No. 26377

(220) 09/05/2012

(732) BELLATOR SPORT WORLDWIDE LLC

1575 N Gower St, Hollywood, CA 90028,

United States Of America

(111) No. 25685

(180) 14/11/2032

(540) Renewal

BEE

(511) 35

(210) No. 26581

(220) 31/05/2012

(732) BEE LOGISTICS CORPORATION

39B Truong Son, Ward 4, Tan Binh District,

Ho Chi Minh City, Vietnam

(111) No. 25885

(180) 15/11/2032

(540) Renewal

BEE

(511) 36

(210) No. 26582

(220) 31/05/2012

(732) BEE LOGISTICS CORPORATION

39B Truong Son, Ward 4, Tan Binh District,
Ho Chi Minh City, Vietnam

(111) No. 25886

(180) 15/11/2032

(540) Renewal

BEE

(511) 39

(210) No. 26583

(220) 31/05/2012

(732) BEE LOGISTICS CORPORATION

39B Truong Son, Ward 4, Tan Binh District,
Ho Chi Minh City, Vietnam

(111) No. 25887

(180) 15/11/2032

(540) Renewal



(511) 35

(210) No. 26649

(220) 07/06/2012

(732) BEE LOGISTICS CORPORATION

39B Truong Son, Ward 4, Tan Binh District,

Ho Chi Minh City, Vietnam

(111) No. 26514

(180) 08/01/2033

(540) Renewal



(511) 36

(210) No. 26650

(220) 07/06/2012

(732) BEE LOGISTICS CORPORATION

39B Truong Son, Ward 4, Tan Binh District,

Ho Chi Minh City, Vietnam

(111) No. 26515

(180) 08/01/2033

(540) Renewal



(511) 39

(210) No. 26651

(220) 07/06/2012

(732) BEE LOGISTICS CORPORATION

39B Truong Son, Ward 4, Tan Binh District,
Ho Chi Minh City, Vietnam

(111) No. 26516

(180) 08/01/2033

(540) Renewal

PEUGEOT 301

(511) 12

(210) No. 26674

(220) 08/06/2012

(732) AUTOMOBILES PEUGEOT

2-10 Boulevard de l'Europe, 78300 POISSY,
France

(111) No. 26531

(180) 08/01/2033

(540) Renewal

The logo consists of the lowercase letter 'i' followed by the uppercase letters 'ETT' in a bold, sans-serif font.

(511) 26

(210) No. 27021

(220) 24/07/2012

(732) ZHEJIANG WEIXING INDUSTRIAL
DEVELOPMENT CO., LTD

Huayuan Industrial Area, Linhai City,
Zhejiang Province, China

(111) No. 26841

(180) 21/03/2033

(540) Renewal



(511) 16

(210) No. 26985

(220) 16/07/2012

(732) UNION INDUSTRIES CORP., LTD

142 Soi Latphrao 80 (Chantima), Latphrao
Road, Wangthonglang Sub-District,
Wangthonglang District, Bangkok 10310,
Thailand

(111) No. 28135

(180) 01/10/2032

(540) Renewal

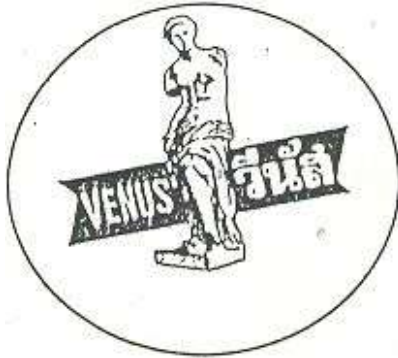

(511) 25

(210) No. 26986

(220) 16/07/2012

(732) UNION INDUSTRIES CORP., LTD

142 Soi Latphrao 80 (Chantima), Latphrao

Road, Wangthonglang Sub-District,

Wangthonglang District, Bangkok 10310,

Thailand

(111) No. 28136

(180) 01/10/2032

ພາກທີ IV

(Part IV)

ເຄື່ອງໝາຍການຄ້າຜ່ານລະບົບມາດຣິດ

Trademarks via Madrid Protocol

4. ການປ່ຽນແປງ

(Changes)

ພາກທີ IV

(Part IV)

ເຄື່ອງໝາຍການຄ້າຜ່ານລະບົບມາດຣິດ

Trademarks via Madrid Protocol

5. ການດັດແກ້

(Amendments)

ພາກທີ V
(Part V)
ຖິ່ນກຳເນີດ
Geographical Indications

1. ຄຳຮ້ອງ
(Applications)

ພາກທີ V
(Part V)
ຖິ່ນກຳເນີດ
Geographical Indications

2. ຜົນການຈົດທະບຽນ
(Registration)

ພາກທີ V

(Part V)

ຖິ່ນກຳເນີດ

Geographical Indications

3. ການປ່ຽນແປງ

(Changes)

ພາກທີ V
(Part V)
ຖິ່ນກຳເນີດ
Geographical Indications

4. ການດັດແກ້
(Amendments)

ພາກທີ VI

(Part VI)

ພັນພືດໃໝ່

New Plant Varieties

1. ຄໍາຮ້ອງ

(Applications)

ພາກທີ VI

(Part VI)

ພັນພືດໃໝ່

New Plant Varieties

2. ຜົນການຈັດທະບຽນ

(Registration)

ພາກທີ VI

(Part VI)

ພັນພືດໃໝ່

New Plant Varieties

3. ການປ່ຽນແປງ

(Changes)

ພາກທີ VI

(Part VI)

ພັນພືດໃໝ່

New Plant Varieties

4. ການດັດແກ້

(Amendments)

ພາກທີ VII

(Part VII)

ລິຂະສິດ ແລະ ສິດກ່ຽວຂ້ອງກັບລິຂະສິດ

Copyrights and Related Rights

1. ການແຈ້ງຂໍ້ມູນ

(Notifications)

ພາກທີ VII

(Part VII)

ລິຂະສິດ ແລະ ສິດກ່ຽວຂ້ອງກັບລິຂະສິດ

Copyrights and Related Rights

2. ການປ່ຽນແປງ

(Changes)

ພາກທີ VIII

(Part VIII)

**ການແກ້ໄຂຂໍ້ຂັດແຍ່ງທາງດ້ານບໍລິຫານກ່ຽວກັບການຈົດທະບຽນຊັບ
ສິນອຸດສາຫະກຳ ແລະ ພັນພືດໃໝ່**

**Administrative Dispute Resolutions on the Registration of
Industrial Property and New Plant Varieties**

1. ຜົນການຄັດຄ້ານຄຳຮ້ອງ

(Result of Oppositions)

ພາກທີ VIII

(Part VIII)

**ການແກ້ໄຂຂໍ້ຂັດແຍ່ງທາງດ້ານບໍລິຫານກ່ຽວກັບການຈົດທະບຽນຊັບ
ສິນອຸດສາຫະກຳ ແລະ ພັນພືດໃໝ່**

**Administrative Dispute Resolutions on the Registration of
Industrial Property and New Plant Varieties**

2. ຜົນການແຈ້ງປະຕິເສດ

(Result of Refusals)

ພາກທີ VIII

(Part VIII)

**ການແກ້ໄຂຂໍ້ຂັດແຍ່ງທາງດ້ານບໍລິຫານກ່ຽວກັບການຈົດທະບຽນຊັບ
ສິນອຸດສາຫະກຳ ແລະ ພັນພືດໃໝ່**

**Administrative Dispute Resolutions on the Registration of
Industrial Property and New Plant Varieties**

**3. ຜົນການຍົກເລີກ ຫຼື ລົບລ້າງ ຂອງການຈົດທະບຽນ
(Result of Cancellation or Invalidation of Registration)**