



ສາທາລະນະລັດ ປະຊາທິປະໄຕ ປະຊາຊົນລາວ
LAO PEOPLE'S DEMOCRATIC REPUBLIC

ກະຊວງ ອຸດສາຫະກຳ ແລະ ການຄ້າ
ກົມຊັບສິນທາງປັນຍາ

MINISTRY OF INDUSTRY AND COMMERCE
DEPARTMENT OF INTELLECTUAL PROPERTY

ຈົດໝາຍເຫດທາງລັດຖະການ
ກ່ຽວກັບ ຊັບສິນທາງປັນຍາ
ຢູ່ ສປປ ລາວ

OFFICIAL GAZETTE ON INTELLECTUAL PROPERTY
IN LAO PDR

ສະບັບທີ (Vol.) 190

ພາກທີ I

(Part I)

ສິດທິບັດ ແລະ ອະນຸສິດທິບັດ (Patent and Petty Patent)

1. ຄໍາຮ້ອງ (Applications)

ຄໍາອະທິບາຍກ່ຽວກັບລະຫັດຫຍໍ້ (Introduction of Codes)

- (21) ເລກທີ ຄໍາຮ້ອງ (Filing Number)
- (22) ວັນທີ ຍືນຄໍາຮ້ອງ (Filing Date)
- (30) ວັນທີ ບຸລິມະສິດ (Priority Date)
- (43) ວັນທີເຜີຍແຜ່ (Publication Date)
- (51) ໝວດ (International Patent Classification)
- (54) ຊື່ຂອງການປະດິດ (Title)
- (57) ບົດຄັດຫຍໍ້ (Abstract)
- (71) ຊື່ ແລະ ທີ່ຢູ່ ເຈົ້າຂອງສິດທິບັດ ແລະ ອະນຸສິດທິບັດ (Owner Name and Address)
- (72) ຊື່ຜູ້ປະດິດ (Inventor Name)
- (74) ຊື່ຕົວແທນ (Representative Name)
- (55) ຮູບພາບ (Pictures)

ພາກທີ I

(Part I)

ສິດທິບັດ ແລະ ອະນຸສິດທິບັດ (Patent and Petty Patent)

2. ຜົນການອອກສິດທິບັດ ແລະ ອະນຸສິດທິບັດ (Grant of Patents and Petty Patents)

ຄຳອະທິບາຍກ່ຽວກັບລະຫັດຫຍໍ້

(Introduction of Codes)

- (11) ເລກທິ (Grant Number)
- (21) ເລກທິ ຄຳຮ້ອງ (Filing Number)
- (22) ວັນທິຍືນຄຳຮ້ອງ (Filing Date)
- (30) ວັນທິ ບຸລິມະສິດ (Priority Date)
- (43) ວັນທິເຜີຍແຜ່ (Publication Date)
- (51) ໝວດ (International Patent Classification)
- (54) ຫົວຂໍ້ການປະດິດ (Title)
- (57) ບົດຄັດຫຍໍ້ (Abstract)
- (71) ຊື່ ແລະ ທີ່ຢູ່ ເຈົ້າຂອງສິດທິບັດ ແລະ ອະນຸສິດທິບັດ (Owner Name and Address)
- (72) ຊື່ຜູ້ປະດິດ (Inventor Name)
- (74) ຊື່ຕົວແທນ (Representative Name)
- (55) ຮູບພາບ (Pictures)

Official Gazette of Industrial Property Vol. 190, 20/01/2023

- (11) No. 446
- (21) PA 446
- (22) 19/10/2016
- (30) MI2014A000766 24/04/2014 IT
- (43)
- (51) Int.Cl. E 02B 3/10, E 02B 3/16, E 02B 3/12
- (54) METHOD AND SYSTEM FOR ANCHORING A WATERPROOFING LINER TO CONCRETE CURBS OF A HYDRAULIC STRUCTURE
- (57) .
- (71) CARPI TECH B.V.
Spoorhaven 88 NL-2651 AV Berkel en Rodenrijs, Netherlands.
- (72) SCUERO ALBERTO MARIA.
- (74) Tilleke & Gibbins Lao Co., Ltd.
- (55)

Official Gazette of Industrial Property Vol. 190, 20/01/2023

- (11) No. 518
- (21) PA 518
- (22) 12/07/2017
- (30) 15/005,289 25/01/2016 US; 62/108,019 26/01/2015 US and PCT/US2016/014810
26/01/2016 US
- (43)
- (51) Int.Cl.H 04L 1/18, H 04L 1/16
- (54) **LOW LATENCY GROUP ACKNOWLEDGEMENTS**
- (57) Certain aspects of the present disclosure provide techniques that may be used for low latency communications. For example, aspects allow a single group acknowledgement to be used to acknowledge a plurality of low latency transmissions. An exemplary method generally includes receiving, from a base station, a plurality of downlink channel transmissions, wherein each of the downlink channel transmissions is sent using a first transmission time interval (TTI) that is reduced relative to a legacy TTI and providing, in a single uplink channel transmission sent using a second TTI that is larger than the first TTI, a group acknowledgement indicating whether or not the downlink channel transmissions were successfully received by a UE.
- (71) **QUALCOMM INCORPORATED**
Attn: International IP Administration 5775 Morehouse Drive San Diego, California 92121-1714 (US), United States of America.
- (72) DAMNJANOVIC, Aleksandar; XU, Hao; Chen, Wanshi; PATEL, Shimman Arvind and GAAL, Peter.
- (74) **CONCETTI-LAO CO., LTD.**
- (55)

Official Gazette of Industrial Property Vol. 190, 20/01/2023

- (11) No. 536
- (21) PA 536
- (22) 28/07/2017
- (30) 15/019,086 09/02/2016 US; 62/114,537 10/02/2015 US and PCT/US2016/017258
10/02/2016 US
- (43)
- (51) Int.Cl.H 04N 19/11, H 04N 19/93, H 04N 19/176, H 04N 19/119
- (54) RESTRICTION ON PALETTE BLOCK SIZE IN VIDEO CODING
- (57) In an example, method of encoding video data may include receiving a block of video data having a size. The method may include determining the size of the block of video data. The method may include disabling palette mode encoding for the block of video data based on the determined size of the block of video data.
- (71) QUALCOMM INCORPORATED
Attn: International IP Administration 5775 Morehouse Drive San Diego, California 92121-1714 (US), United States Of America.
- (72) KARCZEWICZ, Marta; JOSHI, Rajan Laxman and PU, Wei.
- (74) CONCETTI-LAO CO., LTD.
- (55)

Official Gazette of Industrial Property Vol. 190, 20/01/2023

- (11) No. 540
- (21) PA 540
- (22) 01/08/2017
- (30) 14/803,793 20/07/2015 US; 62/114,157 10/02/2015 US; 62/121,326 26/02/2015 US and PCT/US2016/015990 01/02/2016 US
- (43)
- (51) Int.Cl.H 04W 48/12
- (54) ON-DEMAND SYSTEM INFORMATION
- (57) A wireless network may provide system information by either a fixed periodic broadcast or broad-beam transmission or in response to a request by a user equipment (UE). The wireless network may broadcast (or broad-beam transmit) a signal that indicates to the UEs within a cell or zone coverage area that system information is to be transmitted on a fixed periodic schedule or in response to a request sent by one or more UEs.
- (71) QUALCOMM INCORPORATED
Attn: International IP Administration 5775 Morehouse Drive San Diego, California 92121-1714 (US), United States Of America.
- (72) JI, Tingfang; KUBOTA, Keiichi; BHUSHAN, Naga; HORN, Gavin, Bernard; SMEE, John, Edward; SORIAGA, Joseph, Binamira and ZENG, Wei.
- (74) CONCETTI-LAO CO., LTD.
- (55)

Official Gazette of Industrial Property Vol. 190, 20/01/2023

- (11) No. 543
- (21) PA 543
- (22) 04/08/2017
- (30) 15/040,418 10/02/2016 US; 62/115,089 11/02/2015 US and PCT/US2016/017499
11/02/2016 US
- (43)
- (51) Int.Cl.H 04N 21/435, H 04N 21/235
- (54) SIGNALING OF OPERATION POINTS FOR CARRIAGE OF HEVC EXTENSIONS
- (57) A first descriptor describes an operation point. The second descriptor is a hierarchy descriptor or a hierarchy extension descriptor. The second descriptor has a hierarchy layer index value equal to a value of the second syntax element. A first value of a first syntax element in the first descriptor specifies that an elementary stream indicated by a second syntax element in the first descriptor, when not present in an elementary stream list, shall be added into the list, and an elementary stream indicated by an index in the second descriptor, when not present in the list, shall be added to the list. Responsive to determining the first syntax element has a second value different from the first value, adding the elementary stream indicated by the second syntax element, when not present in the list, into the list, but not the elementary stream indicated by the index in the second descriptor.
- (71) QUALCOMM INCORPORATED
Attn: International IP Administration 5775 Morehouse Drive San Diego, CA 92121-1714 ,
United States of America.
- (72) HENDRY, Fnu; WANG, Ye-Kui and CHEN, Ying.
- (74) CONCETTI-LAO CO., LTD.
- (55)

Official Gazette of Industrial Property Vol. 190, 20/01/2023

- (11) No. 635
- (21) PA 635
- (22) 29/01/2019
- (30) 2016903000 29/07/2016 AU; 2016903001 29/07/2016 AU; 2016903055 03/08/2016 AU; 2016903056 03/08/2016 AU; 2016904487 03/11/2016 AU and 2016904488 03/11/2016 AU
- (43)
- (51) Int.Cl. G 01S 13/74(2006.01), G 01S 19/00(2010.01), G 08G 1/00(2006.01)
- (54) SYSTEM, METHOD AND COMPUTER PROGRAM FOR A MONITORING SYSTEM
- (57) Disclosed is a system, method, mobile communication device and one or more computer programs for a monitoring system. In one aspect, the system includes a plurality of transmitters, each transmitter having associated therewith a reflector antenna configured to substantially reflect signal transmission toward a detection area; and a mobile device configured to: receive transmitter signals from at least two transmitters from the plurality of transmitters; and determine that the mobile device is located within the detection area based on received signal strengths of the at least some of the transmitter signals.
- (71) TMA CAPITAL AUSTRALIA PTY LTD
4-6 Straits Avenue South Granville, New South Wales 2142, Australia.
- (72) KARAM, Anthony; LALETIN, Gregori Alexandravich; WALSH, Kevin John and BLAZKIEWICZ, Paul.
- (74) Lao Trademark Agency (LAO IP AGENCY).
- (55)

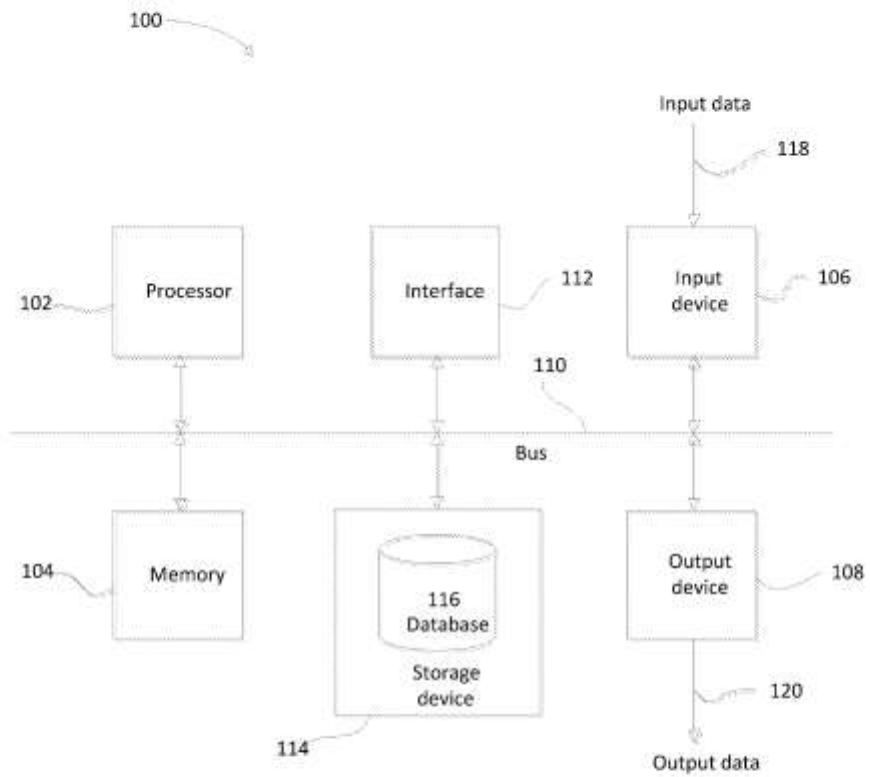

FIGURE 1

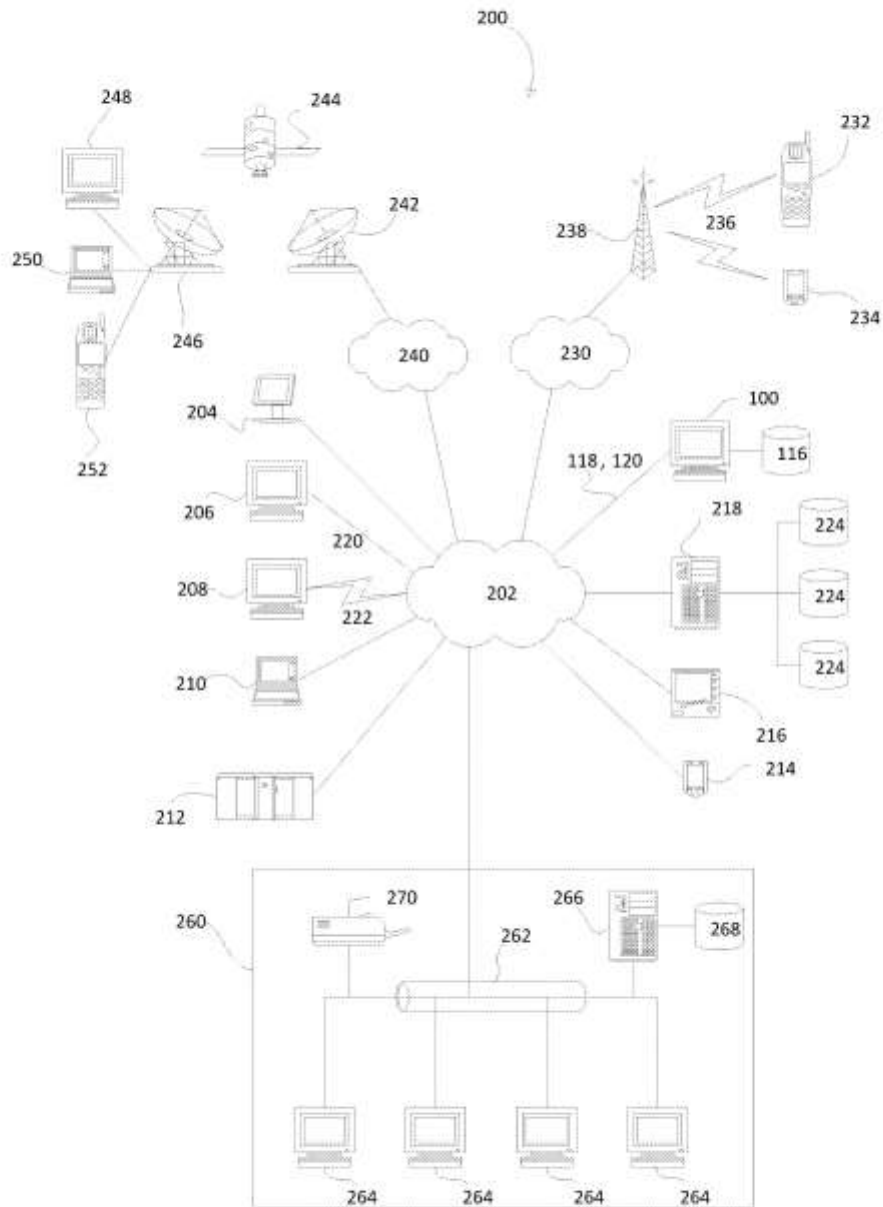

FIGURE 2

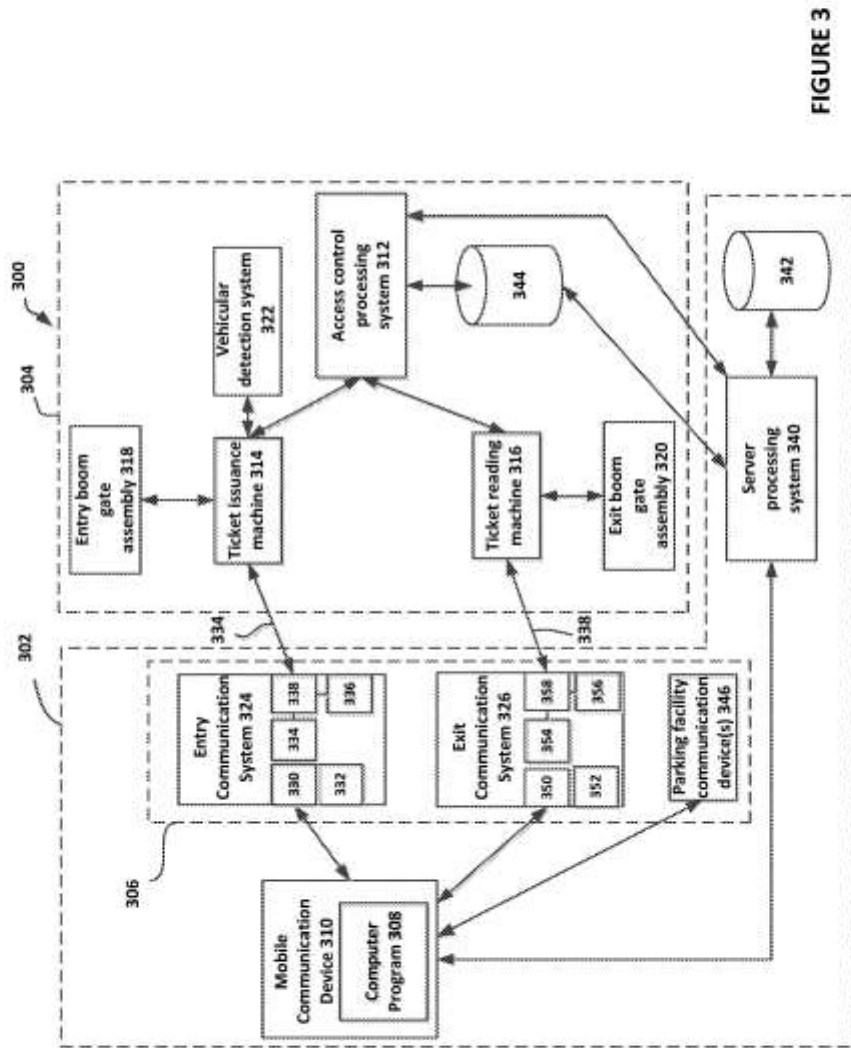

FIGURE 3

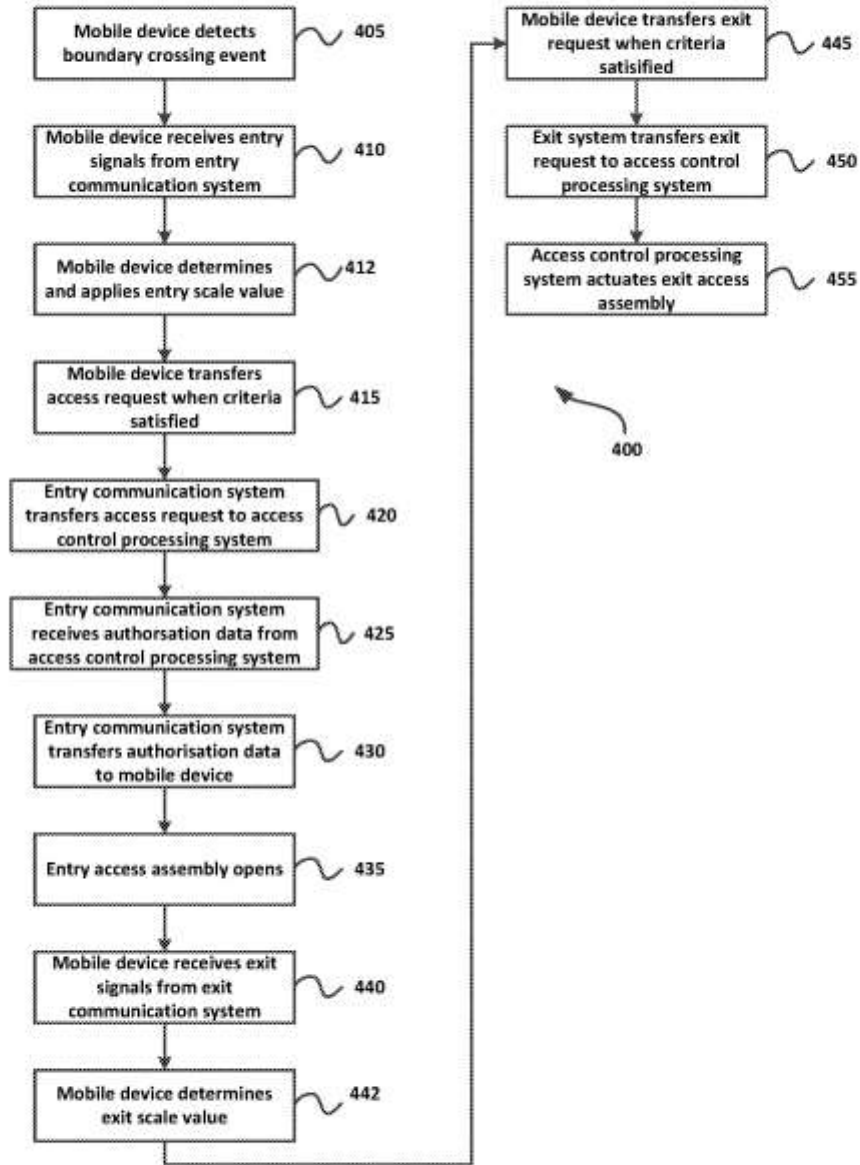

FIGURE 4

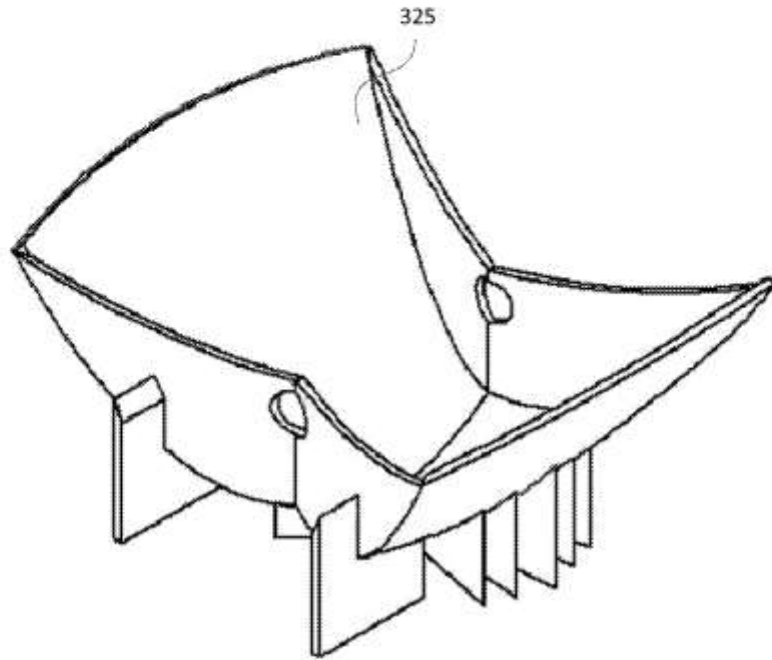

FIGURE 5

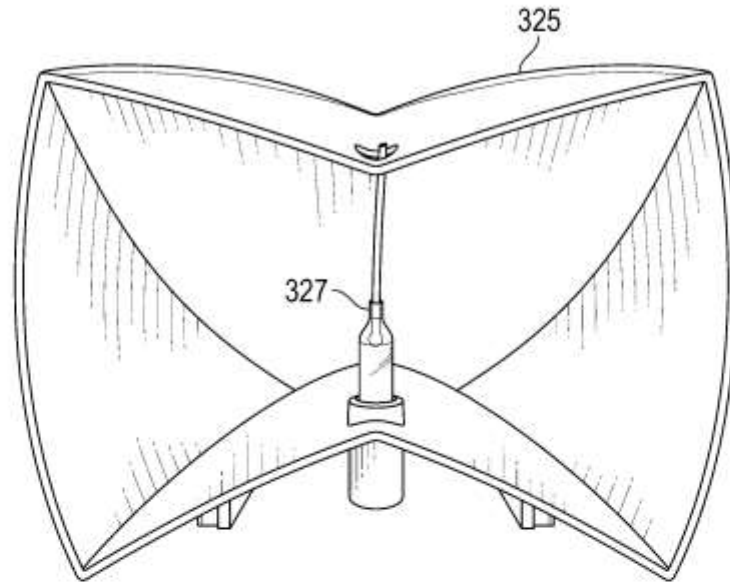

FIG. 6

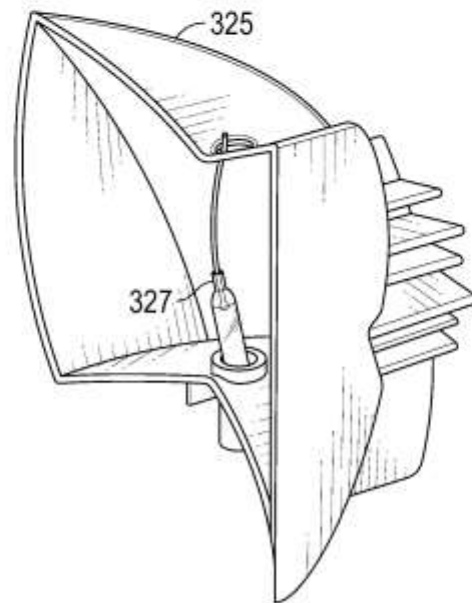

FIG. 7

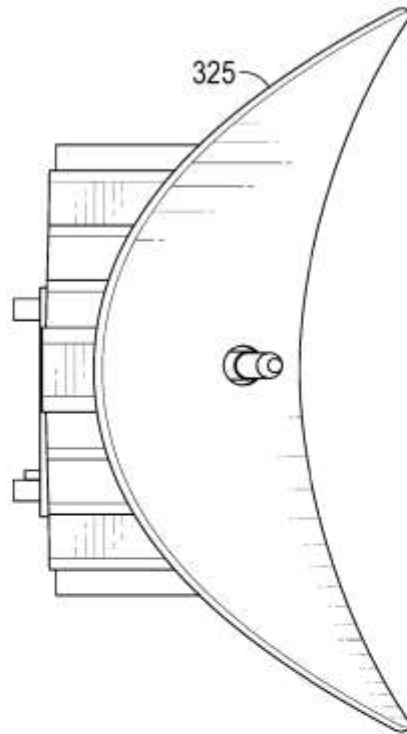

FIG. 8

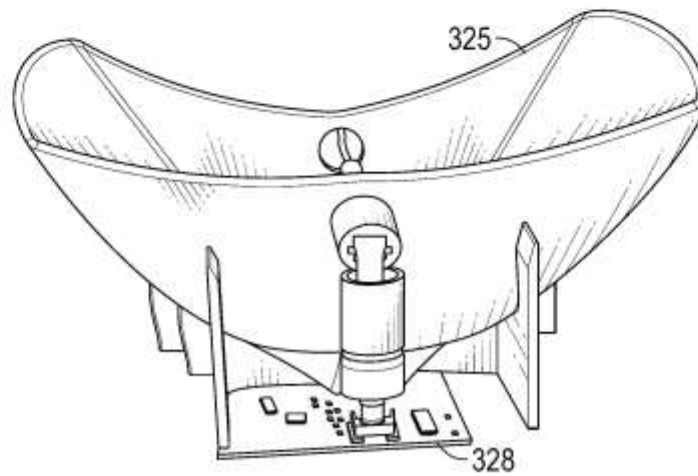

FIG. 9
Substitute Sheet
(Rule 26) RO/AU

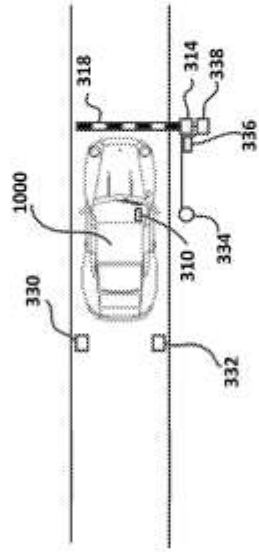

FIGURE 10C

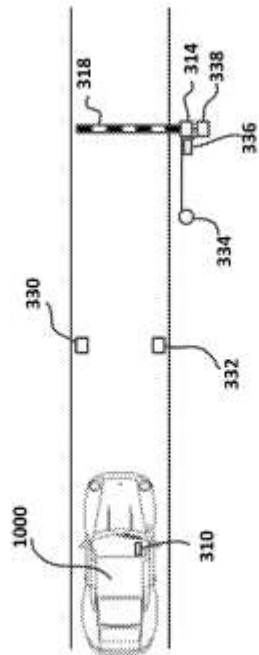

FIGURE 10A

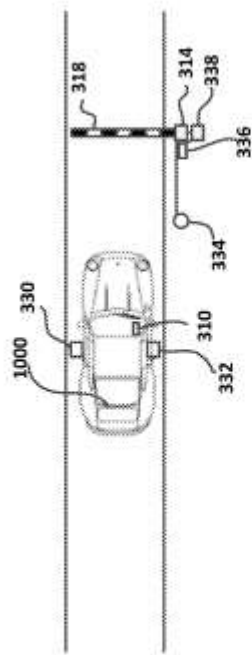

FIGURE 10B

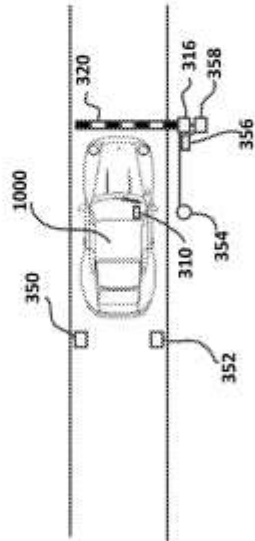

FIGURE 11C

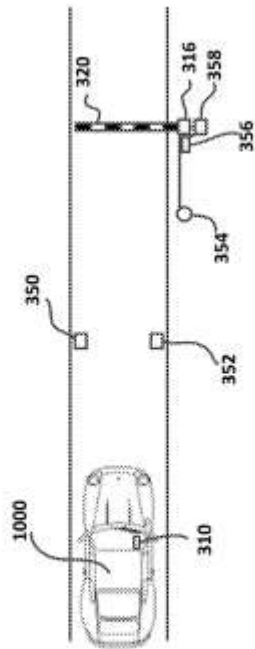

FIGURE 11A

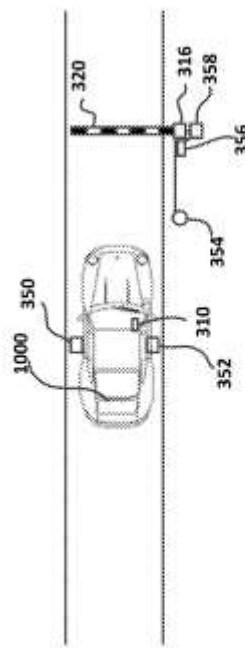

FIGURE 11B

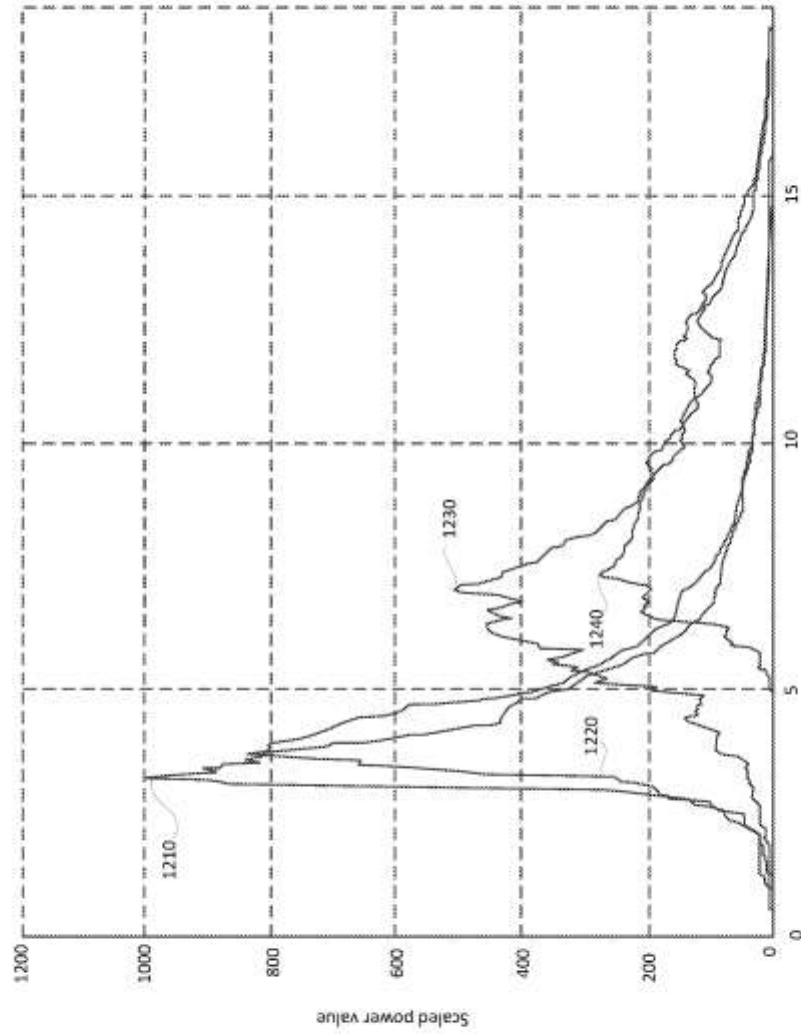

FIGURE 12

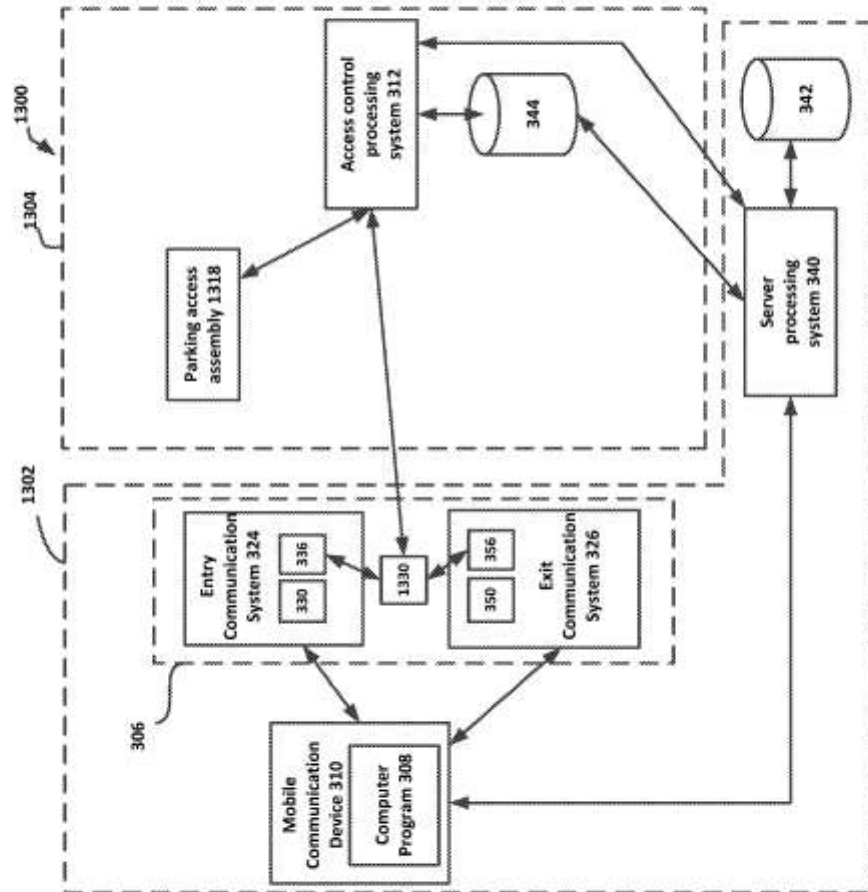

FIGURE 13

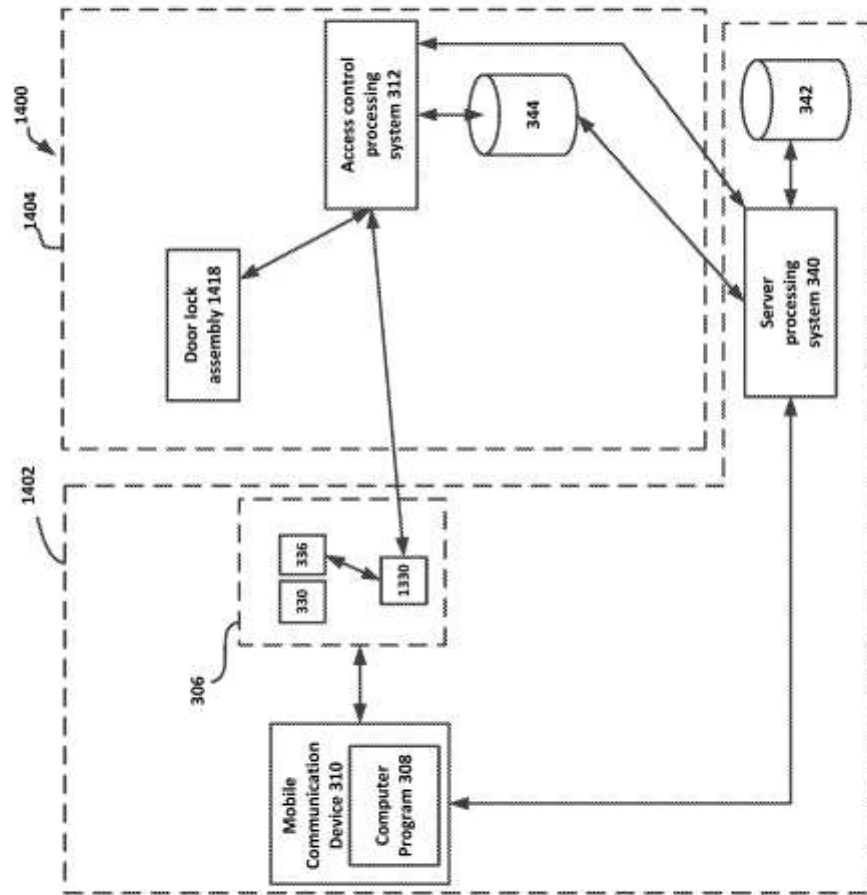

FIGURE 14

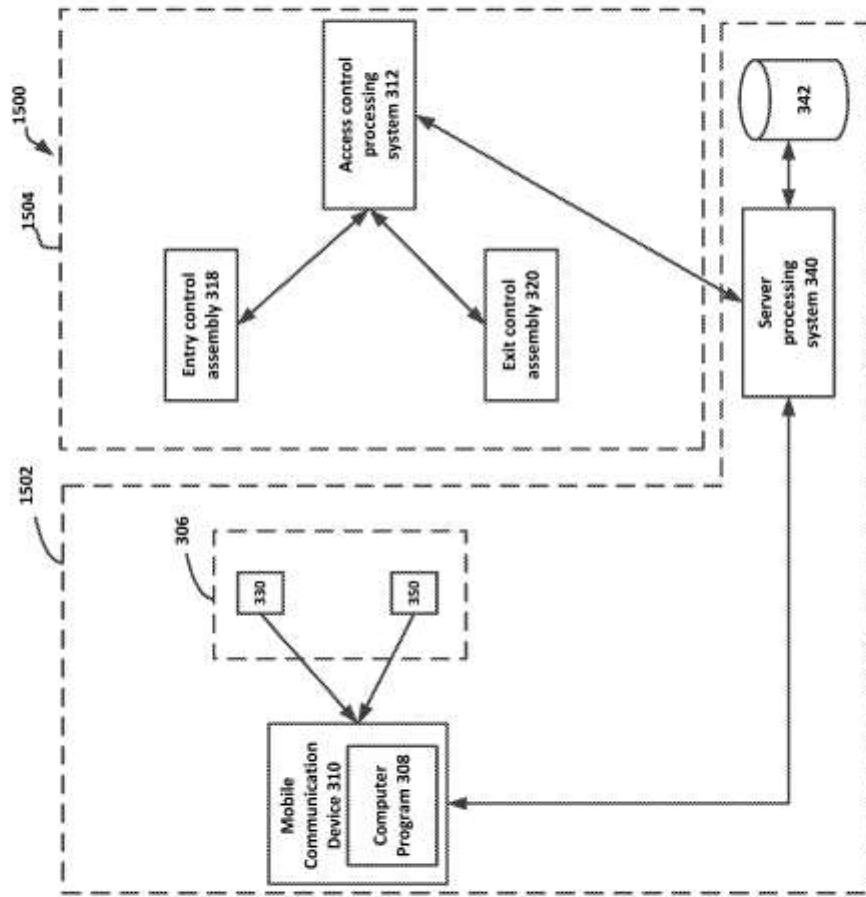

FIGURE 15

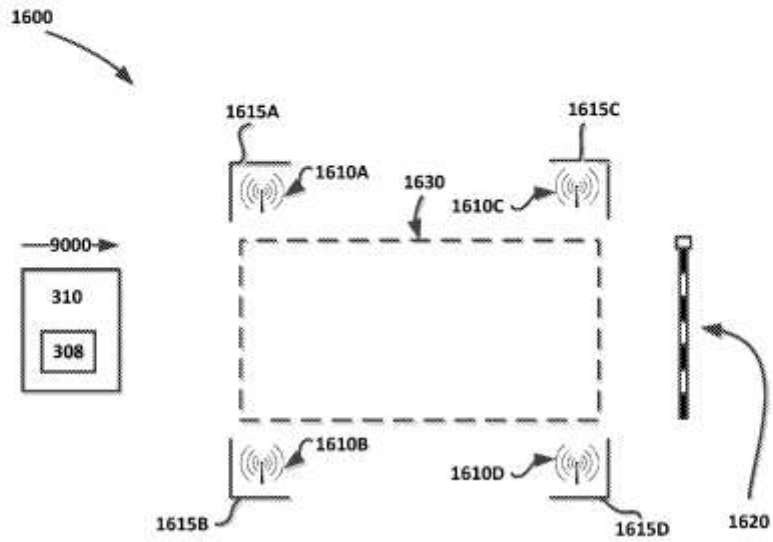

FIGURE 16A

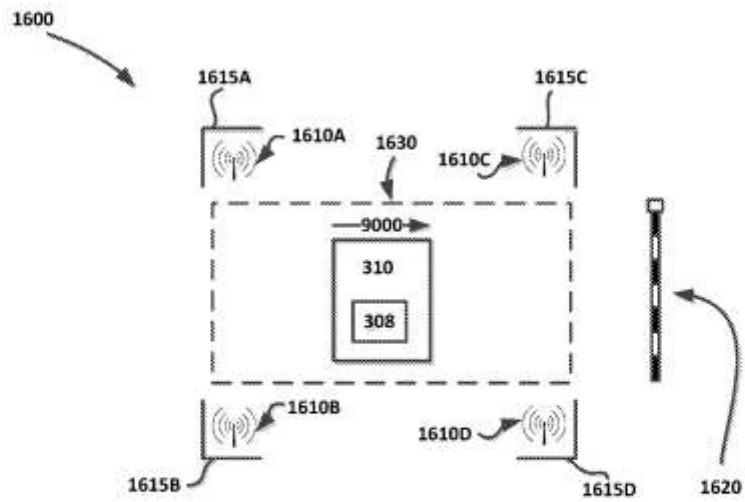

FIGURE 16B

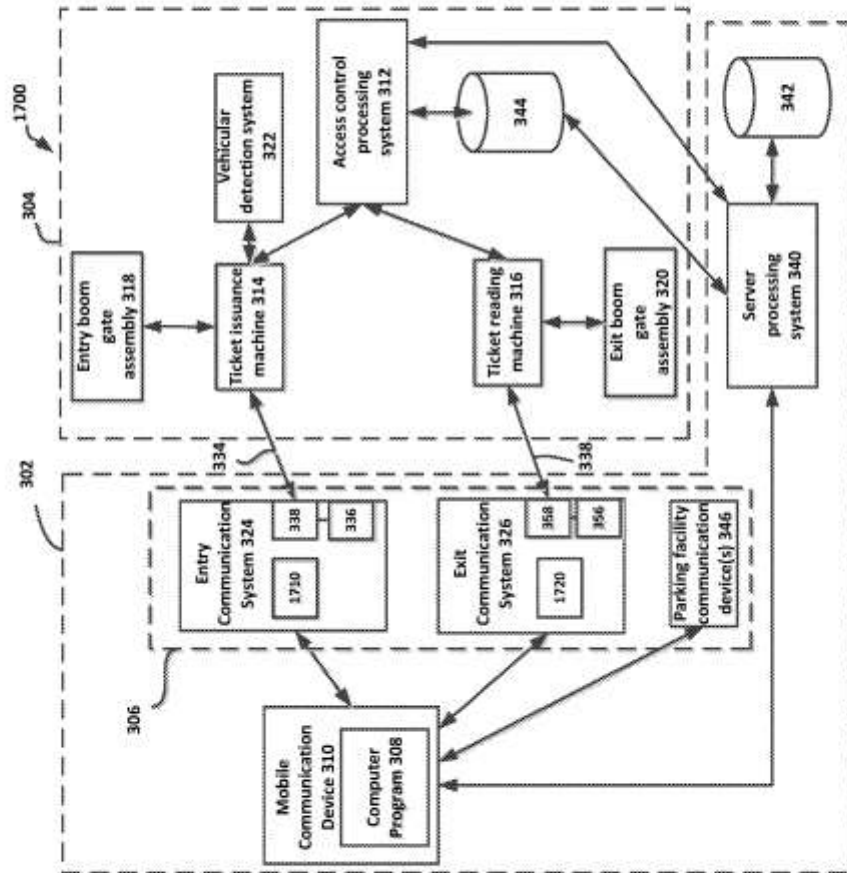

FIGURE 17A

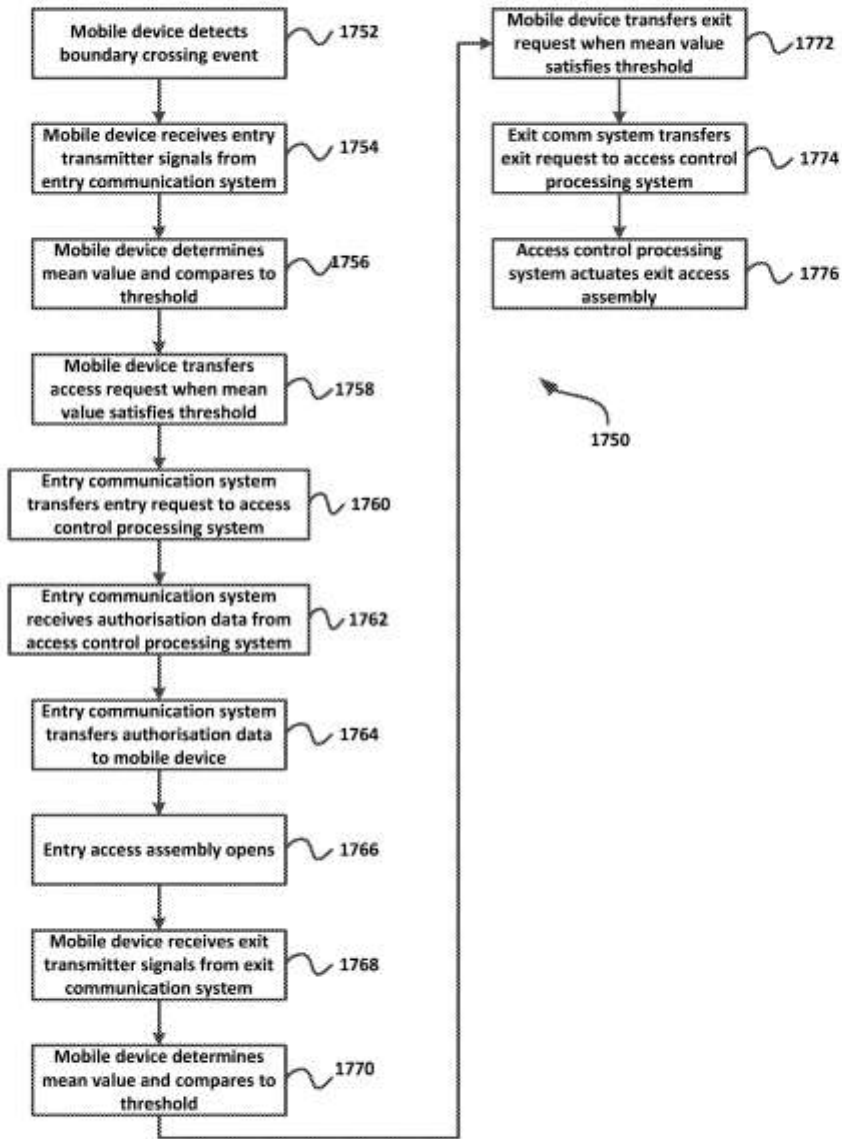

FIGURE 17B

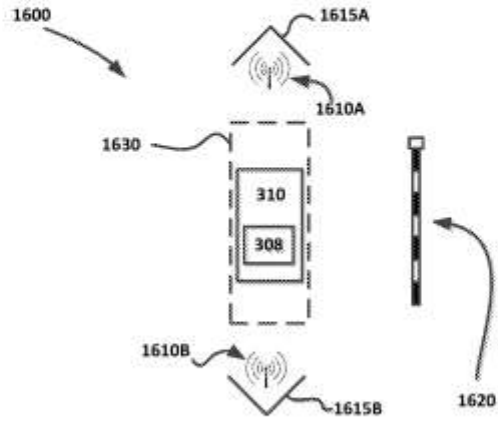

FIGURE 18

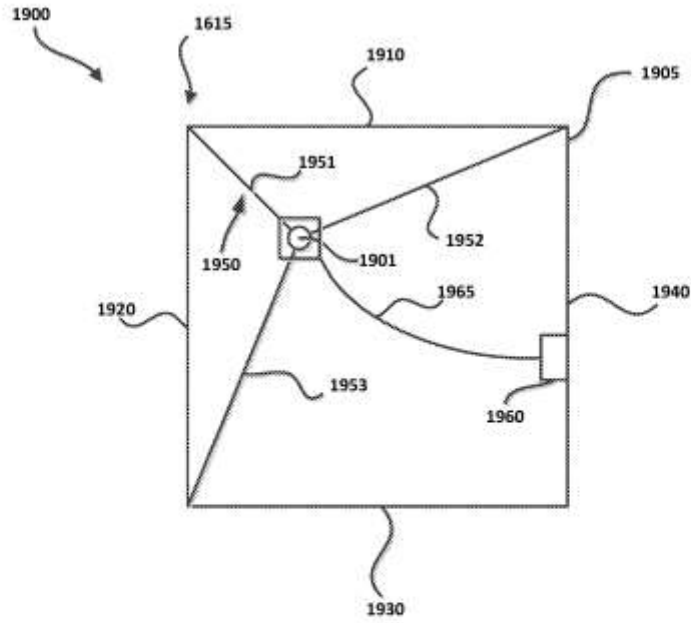

FIGURE 19

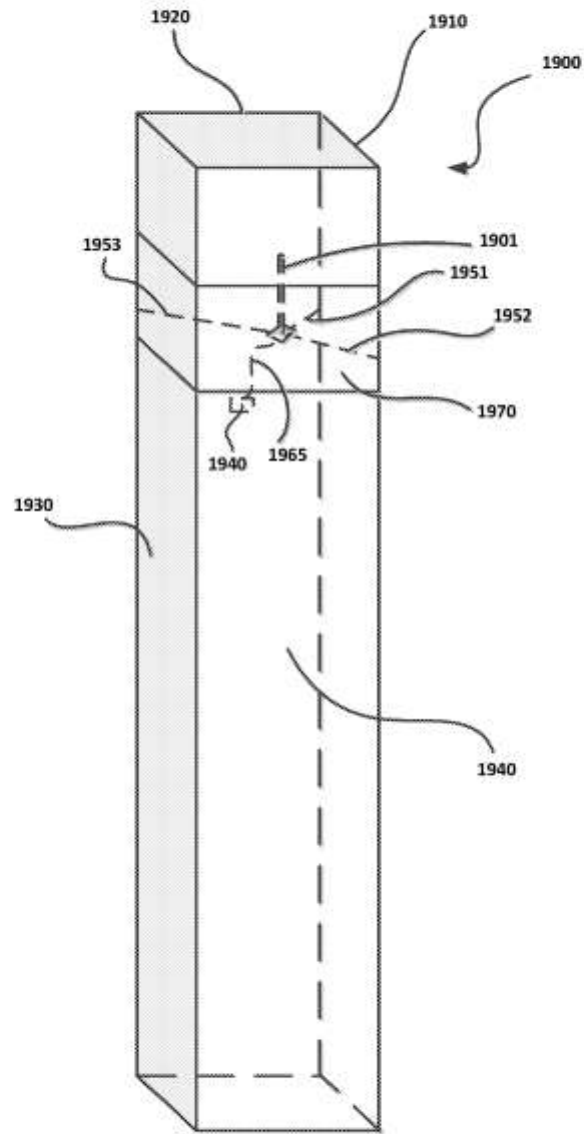

FIGURE 20

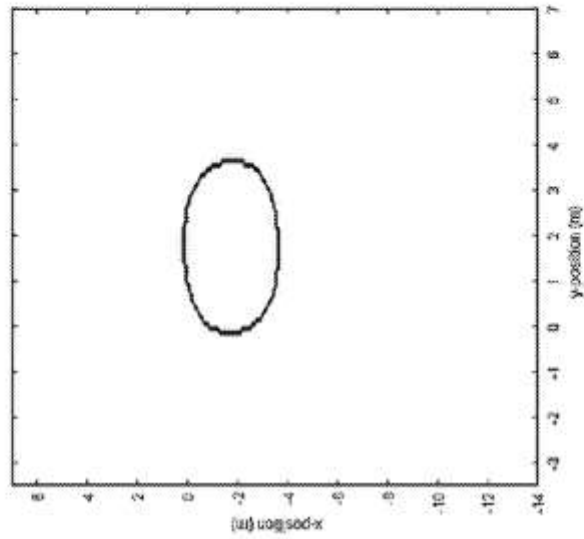

FIGURE 22

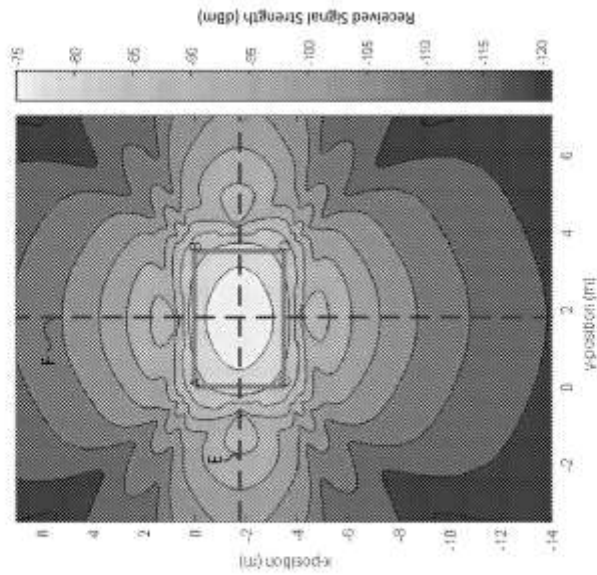

FIGURE 21

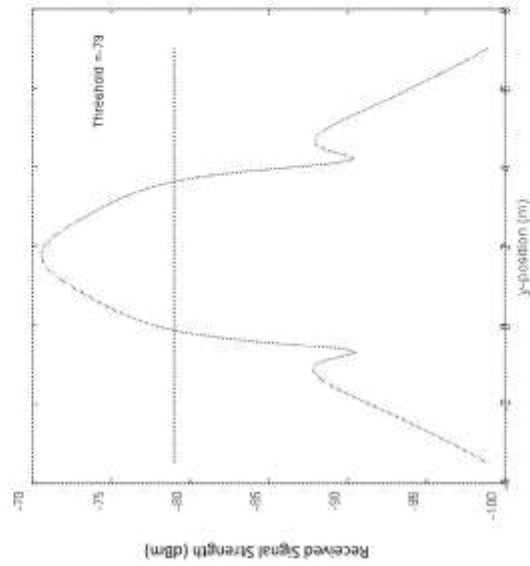

FIGURE 24

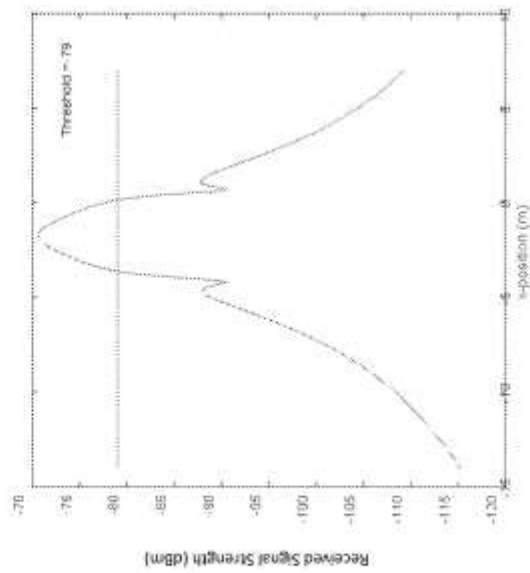

FIGURE 23

ພາກທີ I

(Part I)

**ສິດທິບັດ ແລະ ອະນຸສິດທິບັດ
(Patent and Petty Patent)**

3. ການປ່ຽນແປງ

(Changes)

ພາກທີ I

(Part I)

**ສິດທິບັດ ແລະ ອະນຸສິດທິບັດ
(Patent and Petty Patent)**

4. ການດັດແກ້

(Amendments)

ພາກທີ II
(Part II)
ແບບອຸດສາຫະກຳ
(Industrial Design)

1. ຄຳຮ້ອງ
(Applications)

ຄຳອະທິບາຍກ່ຽວກັບລະຫັດຫຍໍ້
(Introduction of Codes)

- (21) ເລກທີ ຄຳຮ້ອງ (Filing Number)
- (22) ວັນທີ ຄຳຮ້ອງ (Filing Date)
- (30) ວັນທີ ບຸລິມາສິດ (Priority Date)
- (51) ໝວດ (Locarno Classification)
- (54) ຊື່ຂອງແບບອຸດສາຫະກຳ (Title)
- (71) ຊື່ ແລະ ທີ່ຢູ່ ຂອງເຈົ້າຂອງ (Owner Name and Address)
- (72) ຊື່ຜູ້ອອກແບບ (Designer Name)
- (74) ຊື່ຕົວແທນ (Representative Name)
- (55) ຮູບພາບ (Pictures)

ພາກທີ II
(Part II)
ແບບອຸດສາຫະກຳ
(Industrial Design)

2. ຜົນການຈົດທະບຽນ
(Registration)

ຄຳອະທິບາຍກ່ຽວກັບລະຫັດຫຍໍ້
(Introduction of Codes)

- (11) ເລກທີ ຈົດທະບຽນ (Registration Number)
- (15) ວັນທີ ຈົດທະບຽນ (Registration Date)
- (21) ເລກທີ ຍືນຄຳຮ້ອງ (Filing Number)
- (22) ວັນທີ ຍືນຄຳຮ້ອງ (Filing Date)
- (30) ວັນທີ ບຸລິມາສິດ (Priority Date)
- (17) ວັນທີ ໝົດອາຍຸ (Expiration Date)
- (51) ໝວດ (Locarno Classification)
- (54) ຊື່ຂອງແບບອຸດສາຫະກຳ (Title)
- (71) ຊື່ ແລະ ທີ່ຢູ່ ຂອງເຈົ້າຂອງ (Owner Name and Address)
- (72) ຊື່ຜູ້ອອກແບບ (Designer Name)
- (74) ຊື່ຕົວແທນ (Representative Name)
- (55) ຮູບພາບ (Pictures)

ພາກທີ II
(Part II)
ແບບອຸດສາຫະກຳ
(Industrial Design)

3. ການປ່ຽນແປງ
(Changes)

ພາກທີ II

(Part II)

ແບບອຸດສາຫະກຳ

(Industrial Design)

4. ການດັດແກ້

(Amendments)

ພາກທີ III
(Part III)
ເຄື່ອງໝາຍການຄ້າ
Trademarks

1. ຄໍາຮ້ອງ
(Applications)

ຄໍາອະທິບາຍກ່ຽວກັບລະຫັດຫຍໍ້
(Introduction of Codes)

- (540) ເຄື່ອງໝາຍການຄ້າ (Trademark)
- (511) ໝວດ (Nice Classification)
- (210) ເລກທີ ຄໍາຮ້ອງ (Number of the application)
- (220) ວັນທີ ຄໍາຮ້ອງ (Date of filing of the application)
- (732) ຊື່ ແລະ ທີ່ຢູ່ ຂອງຜູ້ຍື່ນຄໍາຮ້ອງ (Name and Address of applicant)

ພາກທີ III

(Part III)

ເຄື່ອງໝາຍການຄ້າ

Trademarks

2. ຜົນການຈົດທະບຽນ

(Registration)

ຄຳອະທິບາຍກ່ຽວກັບລະຫັດຫຍໍ້

(Introduction of Codes)

- (540) ເຄື່ອງໝາຍການຄ້າ (Trademark)
- (511) ໝວດ (Nice Classification)
- (210) ເລກທີ ຄຳຮ້ອງ (Number of the application)
- (220) ວັນທີ ຄຳຮ້ອງ (Date of filing of the application)
- (732) ຊື່ ແລະ ທີ່ຢູ່ ຂອງຜູ້ຍື່ນຄຳຮ້ອງ (Name and Address of applicant)
- (111) ເລກທີ ການຈົດທະບຽນເຄື່ອງໝາຍການຄ້າ (Number of the registration)
- (180) ວັນໝົດອາຍຸຂອງການຈົດທະບຽນ (Expiration date of the registration)

(540)



(511) 43

(210) No. 46178

(220) 01/09/2021

(732) ທ່ານ ໄຊສຸລິ ສຸວັນນະຈັກ

ບ້ານ ໜອງຜະຍາ, ເມືອງສີໂຄດຕະບອງ,

ນະຄອນຫຼວງວຽງຈັນ, ສປປ ລາວ

(111) No. 56051

(180) 01/09/2031

ພາກທີ III
(Part III)
ເຄື່ອງໝາຍການຄ້າ
Trademarks

3. ການຕໍ່ອາຍຸ
(Renewal)

ຄຳອະທິບາຍກ່ຽວກັບລະຫັດຫຍໍ້
(Introduction of Codes)

- (540) ເຄື່ອງໝາຍການຄ້າ (Trademark)
- (511) ໝວດ (Nice Classification)
- (210) ເລກທີ ຄຳຮ້ອງ (Number of the application)
- (220) ວັນທີ ຄຳຮ້ອງ (Date of filing of the application)
- (732) ຊື່ ແລະ ທີ່ຢູ່ ຂອງຜູ້ຍື່ນຄຳຮ້ອງ (Name and Address of applicant)
- (111) ເລກທີການຈັດທະບຽນເຄື່ອງໝາຍການຄ້າ (Number of the registration)
- (180) ການຕໍ່ອາຍຸການຈັດທະບຽນ (Expiration date of the renewal)

(540) Renewal

GRIPPER

(511) 26

(210) No. 1119

(220) 21/07/1992

(732) Morito Scovill Americas, LLC

1802 Scovill Drive, Clarkesville, Georgia
30523, United States of America

(111) No. 1070

(180) 21/07/2032

(540) Renewal

SCOVILL

(511) 26

(210) No. 1121

(220) 21/07/1992

(732) Morito Scovill Americas, LLC

1802 Scovill Drive, Clarkesville, Georgia
30523, United States of America

(111) No. 1072

(180) 21/07/2032

ພາກທີ III

(Part III)

ເຄື່ອງໝາຍການຄ້າ

Trademarks

4. ການປ່ຽນແປງ

(Changes)

ພາກທີ III
(Part III)
ເຄື່ອງໝາຍການຄ້າ
Trademarks

5. ການດັດແກ້
(Amendments)

ພາກທີ IV

(Part IV)

ເຄື່ອງໝາຍການຄ້າຜ່ານລະບົບມາດຣິດ

Trademarks via Madrid Protocol

1. ຄໍາຮ້ອງ

(Applications)

ຄໍາອະທິບາຍກ່ຽວກັບລະຫັດຫຍໍ້

(Introduction of Codes)

- (540) ເຄື່ອງໝາຍການຄ້າ (Trademark)
- (511) ໝວດ (Nice Classification)
- (210) ເລກທີ ຄໍາຮ້ອງ (Number of the application)
- (220) ວັນທີ ຄໍາຮ້ອງ (Date of filing of the application)
- (732) ຊື່ ແລະ ທີ່ຢູ່ ຂອງຜູ້ຍື່ນຄໍາຮ້ອງ (Name and Address of applicant)

(540)

SAINT-GOBAIN

(511) 01, 02, 03, 06, 07, 08, 09, 10, 11, 12, 17, 19,
20, 21, 22, 23, 24, 37, 38, 40 and 42

(210) No. M/0740183

(220) 18/11/2022

(732) COMPAGNIE DE SAINT-GOBAIN

Tour SAINT-GOBAIN, 12 place de l'Iris F-
92400 Courbevoie, France

(540)



(511) 05, 29 and 30

(210) No. M/1419172

(220) 18/07/2022

(732) Haya Labs LLC

1120 20th Street NW, South Tower Suite S-
300 Washington DC 20036,
United States of America

(540)

finenolo

(511) 02, 07, 08, 09, 16, 18, 21 and 28

(210) No. M/1645078

(220) 08/12/2022

(732) DELI GROUP CO., LTD.

Deli Industrial Park, Ninghai County, Ningbo
310000 Zhejiang, China

(540)

ITZY

(511) 14

(210) No. M/1706858

(220) 16/12/2022

(732) JYP Entertainment Corporation

JYP Center, 205, Gangdong-daero, Gangdong-
gu Seoul, Republic of Korea

(540)



(511) 31

(210) No. M/1706917

(220) 24/11/2022

(732) SANLLO EXPORT, S.L.

Ctra. Madrid, 48 E-46816 ROTGLA-
CORBERA (VALENCIA), Spain

(540)

BMW ALPINA

(511) 12 and 37

(210) No. M/1706976

(220) 24/08/2022

(732) Bayerische Motoren Werke Aktiengesellschaft

Petuelring 130 80809 München, Germany

(540)



(511) 03, 06, 09, 11, 14, 16, 18, 20, 24, 25, 26, 28, 34, 35, 38, 39, 41, 42 and 43

(210) No. M/1707040

(220) 28/07/2022

(732) The Liverpool Football Club and Athletic
Grounds Limited
Anfield Road Liverpool L4 0TH,
United Kingdom

(540)

LDC.
Louis Dreyfus Company

(511) 05, 09 and 44

(210) No. M/1707155

(220) 25/10/2022

(732) LOUIS DREYFUS TRADEMARKS B.V.
WTC AMSTERDAM, H-25 Zuidplein 208
NL-1077 XV Amsterdam, Netherlands

(540)

Danny Home

(511) 21

(210) No. M/1707411

(220) 15/11/2022

(732) Yiwu Baituan Commodities Co., LTD
Unit 2, Building 32, District B, Xiazhu
Village, Jiangdong Street, Yiwu City 322023
Zhejiang Province, China

(540)



(511) 03, 09, 10, 18, 25 and 43

(210) No. M/1707414

(220) 02/09/2022

(732) Shenzhen Janez Technology Co., Ltd.
Room 1405, HanKing Financial Centre, No.
9968 Shennan Road, Maling Community,
Yuehai Street, Nanshan District 518052
Shenzhen, China

(540)

CASA
MAESTRI



Reserva
de MFM

(511) 33

(210) No. M/1707472

(220) 30/11/2022

(732) Destiladora del Valle de Tequila SA de CV
Carretera Internacional #102 Colonia Santa
Cruz de Los Espinos 46403 Tequila, Jalisco
C.P., Mexico

(540)

Prosperity Legend

(511) 09, 28 and 41

(210) No. M/1707517

(220) 06/10/2022

(732) Euro Games Technology Ltd.
4, "Maritsa" Str. "Vranya-Lozen-Triugulnika"
BG-1151 Sofia, Bulgaria

(540)



(511) 42 and 44

(210) No. M/1707531

(220) 21/10/2022

(732) VISMEDERI HOLDING S.R.L.

UNIPERSONALE

VIA FRANCO FERRINI, 53 - LOC.

TOGNAZZA - SAN MARTINO I-53035

MONTERIGGIONI (SI), ITALY

(540)



Gong cha

(511) 30, 32, 35 and 43

(210) No. M/1707563

(220) 17/11/2022

(732) Gong cha Global Ltd

Unit 34a Waterside, 44-48 Wharf Road

London N1 7UX, United Kingdom

(540)

The logo for UFCS, consisting of the letters 'UFCS' in a bold, italicized, sans-serif font.

(511) 09

(210) No. M/1707566

(220) 10/10/2022

(732) Fast Charging Alliance

Room 305, 3F, Building Y4, Creative Park,
No. 5 Yayuan Road, Nankeng Community,
Bantian Jiedao, Longgang District, Shenzhen
518100 Guangdong Province, China

(540)

The logo for AVP, consisting of the letters 'AVP' in a bold, italicized, sans-serif font.

(511) 34

(210) No. M/1707635

(220) 03/11/2022

(732) SHENZHEN IVPS TECHNOLOGY
CO.,LTD.

Room 101, Building B8, No.2, Cengyao
Industrial Zone, Yulv Community, Yutang
Street, Guangming District, Shenzhen 518132
Guangdong, China

(540)

Nord

(511) 12

(210) No. M/1707644

(220) 29/11/2022

(732) OnePlus Technology (Shenzhen) Co., Ltd.

18C02, 18C03, 18C04, and 18C05, Shum Yip

Terra Building, Binhe Avenue North, Futian

District, Shenzhen Guangdong, China

(540)

mavic

(511) 34

(210) No. M/1707663

(220) 07/11/2022

(732) SHENZHEN IVPS TECHNOLOGY CO.,LTD.

Room 101, Building B8, No.2, Cengyao

Industrial Zone, Yulv Community, Yutang

Street, Guangming District, Shenzhen 518132

Guangdong, China

(540)

艾十二

(511) 05

(210) No. M/1707724

(220) 05/07/2022

(732) Bozhou Aikeshu Medical Technology Co.,
Ltd

Building 10, Detong Food Industrial Park,
Lixin County, Bozhou City Anhui, China

(540)



(511) 09, 28 and 41

(210) No. M/1707753

(220) 05/10/2022

(732) Euro Games Technology Ltd.

"Maritsa" Str. 4, "Vranya-Lozen-Triugulnika"
BG-1151 Sofia, Bulgaria

(540)



(511) 07, 12 and 35

(210) No. M/1707792

(220) 01/11/2022

(732) GUANGDONG MANCANDO
INFORMATION TECHNOLOGY CO.,
LTD.

Floor 22 (Whole Floor), Vanke Sanyuanli
Center, No. 31, Airport Road, Baiyun District,
Guangzhou City 510080 Guangdong
Province, China

(540)

LINEARTHINKING

(511) 41

(210) No. M/1707800

(220) 14/10/2022

(732) LE DINH LUC

74A Nguyen Trai, Yen Do Ward, Pleiku
City Gia Lai Province, Vietnam

(540)

MiPEN

(511) 34

(210) No. M/1707801

(220) 04/11/2022

(732) SHENZHEN IVPS TECHNOLOGY CO.
LTD.

101, Building B8, No. 2, Cengyao Industrial
Area, Yulv Community, Yutang Subdistrict,
Guangming District, Shenzhen 518000
Guangdong, China

ພາກທີ IV

(Part IV)

ເຄື່ອງໝາຍການຄ້າຜ່ານລະບົບມາດຣິດ

Trademarks via Madrid Protocol

2. ຜົນການຈົດທະບຽນ

(Registration)

ຄຳອະທິບາຍກ່ຽວກັບລະຫັດຫຍໍ້

(Introduction of Codes)

- (540) ເຄື່ອງໝາຍການຄ້າ (Trademark)
- (511) ໝວດ (Nice Classification)
- (210) ເລກທີ ຄຳຮ້ອງ (Number of the application)
- (220) ວັນທີ ຍື່ນຄຳຮ້ອງ (Date of filing of the application)
- (732) ຊື່ ແລະ ທີ່ຢູ່ ຂອງຜູ້ຍື່ນຄຳຮ້ອງ (Name and Address of applicant)
- (111) ເລກທີການຈົດທະບຽນເຄື່ອງໝາຍການຄ້າ (Number of the registration)
- (180) ວັນໝົດອາຍຸຂອງການຈົດທະບຽນ (Expiration date of the registration)

(540)

SETIC

(511) 07 and 42

(210) No. M/1628010

(220) 28/03/2022

(732) SETIC

126 rue de Mâtel, Zone Industrielle de Mâtel F-
42300 Roanne, France

(111) No. M/1628010

(180) 14/09/2031

(540)

SENROG

(511) 08 and 23

(210) No. M/1661088

(220) 30/03/2022

(732) Ningbo Senrog Tools Co., Ltd.

Room 1104, No. 158 Taian Middle Road,
Shounan Sub-District, Yinzhou District,
Ningbo City 315000 Zhejiang, China

(111) No. M/1661088

(180) 30/03/2032

ພາກທີ IV

(Part IV)

ເຄື່ອງໝາຍການຄ້າຜ່ານລະບົບມາດຣິດ

Trademarks via Madrid Protocol

3. ຜົນການຕໍ່ອາຍຸ

(Renewal)

ຄຳອະທິບາຍກ່ຽວກັບລະຫັດຫຍໍ້

(Introduction of Codes)

- (540) ເຄື່ອງໝາຍການຄ້າ (Trademark)
- (511) ໝວດ (Nice Classification)
- (210) ເລກທີ ຄຳຮ້ອງ (Number of the application)
- (220) ວັນທີ ຍື່ນຄຳຮ້ອງ (Date of filing of the application)
- (732) ຊື່ ແລະ ທີ່ຢູ່ ຂອງຜູ້ຍື່ນຄຳຮ້ອງ (Name and Address of applicant)
- (111) ເລກທີການຈົດທະບຽນເຄື່ອງໝາຍການຄ້າ (Number of the registration)
- (180) ການຕໍ່ອາຍຸຂອງການຈົດທະບຽນ (Expiration date of the renewal)

ພາກທີ IV

(Part IV)

ເຄື່ອງໝາຍການຄ້າຜ່ານລະບົບມາດຣິດ

Trademarks via Madrid Protocol

4. ການປ່ຽນແປງ

(Changes)

ພາກທີ IV

(Part IV)

ເຄື່ອງໝາຍການຄ້າຜ່ານລະບົບມາດຣິດ

Trademarks via Madrid Protocol

5. ການດັດແກ້

(Amendments)

ພາກທີ V
(Part V)
ຖິ່ນກຳເນີດ
Geographical Indications

1. ຄຳຮ້ອງ
(Applications)

ພາກທີ V
(Part V)
ຖິ່ນກຳເນີດ
Geographical Indications

2. ຜົນການຈົດທະບຽນ
(Registration)

ພາກທີ V

(Part V)

ຖິ່ນກຳເນີດ

Geographical Indications

3. ການປ່ຽນແປງ

(Changes)

ພາກທີ V
(Part V)
ຖິ່ນກຳເນີດ
Geographical Indications

4. ການດັດແກ້
(Amendments)

ພາກທີ VI

(Part VI)

ພັນພືດໃໝ່

New Plant Varieties

1. ຄໍາຮ້ອງ

(Applications)

ພາກທີ VI

(Part VI)

ພັນພືດໃໝ່

New Plant Varieties

2. ຜົນການຈັດທະບຽນ

(Registration)

ພາກທີ VI
(Part VI)

ພັນພືດໃໝ່
New Plant Varieties

3. ການປ່ຽນແປງ
(Changes)

ພາກທີ VI

(Part VI)

ພັນພືດໃໝ່

New Plant Varieties

4. ການດັດແກ້

(Amendments)

ພາກທີ VII

(Part VII)

ລິຂະສິດ ແລະ ສິດກ່ຽວຂ້ອງກັບລິຂະສິດ

Copyrights and Related Rights

1. ການແຈ້ງຂໍ້ມູນ

(Notifications)

ພາກທີ VII

(Part VII)

ລິຂະສິດ ແລະ ສິດກ່ຽວຂ້ອງກັບລິຂະສິດ

Copyrights and Related Rights

2. ການປ່ຽນແປງ

(Changes)

ພາກທີ VIII

(Part VIII)

ການແກ້ໄຂຂໍ້ຂັດແຍ່ງທາງດ້ານບໍລິຫານກ່ຽວກັບການຈົດທະບຽນຊັບ

ສິນອຸດສາຫະກຳ ແລະ ພັນພືດໃໝ່

**Administrative Dispute Resolutions on the Registration of
Industrial Property and New Plant Varieties**

1. ຜົນການຄັດຄ້ານຄຳຮ້ອງ

(Result of Oppositions)

ພາກທີ VIII

(Part VIII)

**ການແກ້ໄຂຂໍ້ຂັດແຍ່ງທາງດ້ານບໍລິຫານກ່ຽວກັບການຈົດທະບຽນຊັບ
ສິນອຸດສາຫະກຳ ແລະ ພັນພືດໃໝ່**

**Administrative Dispute Resolutions on the Registration of
Industrial Property and New Plant Varieties**

2. ຜົນການແຈ້ງປະຕິເສດ

(Result of Refusals)

ພາກທີ VIII

(Part VIII)

**ການແກ້ໄຂຂໍ້ຂັດແຍ່ງທາງດ້ານບໍລິຫານກ່ຽວກັບການຈົດທະບຽນຊັບ
ສິນອຸດສາຫະກຳ ແລະ ພັນພືດໃໝ່**

**Administrative Dispute Resolutions on the Registration of
Industrial Property and New Plant Varieties**

**3. ຜົນການຍົກເລີກ ຫຼື ລົບລ້າງ ຂອງການຈົດທະບຽນ
(Result of Cancellation or Invalidation of Registration)**