



**ສາທາລະນາລັດ ປະຊາທິປະໄຕ ປະຊາຊົນລາວ**  
**LAO PEOPLE'S DEMOCRATIC REPUBLIC**

**ກະຊວງ ອຸດສາຫະກຳ ແລະ ການຄ້າ**  
**ກົມຊັບສິນທາງປັນຍາ**

**MINISTRY OF INDUSTRY AND COMMERCE**  
**DEPARTMENT OF INTELLECTUAL PROPERTY**

**ຈົດໝາຍເຫດທາງລັດຖະການ**  
**ກ່ຽວກັບ ຊັບສິນທາງປັນຍາ**  
**ຢູ່ ສປປ ລາວ**

**OFFICIAL GAZETTE ON INTELLECTUAL PROPERTY**  
**IN LAO PDR**

ສະບັບທີ (Vol.) 199

# ພາກທີ I (Part I)

## ສິດທິບັດ ແລະ ອະນຸສິດທິບັດ (Patent and Petty Patent)

### 1. ຄໍາຮ້ອງ (Applications)

#### ຄໍາອະທິບາຍກ່ຽວກັບລະຫັດຫຍໍ້ (Introduction of Codes)

- (21) ເລກທີ ຄໍາຮ້ອງ (Filing Number)
- (22) ວັນທີ ຍືນຄໍາຮ້ອງ (Filing Date)
- (30) ວັນທີ ບ ລິມະສິດ (Priority Date)
- (43) ວັນທີເຜີຍແຜ່ (Publication Date)
- (51) ໝວດ (International Patent Classification)
- (54) ຊື່ຂອງການປະດິດ (Title)
- (57) ບົດຄັດຫຍໍ້ (Abstract)
- (71) ຊື່ ແລະ ທີ່ຢ ບໍ ເຈົ້າຂອງສິດທິບັດ ແລະ ອະນ ສິດທິບັດ (Owner Name and Address)
- (72) ຊື່ຜູ້ປະດິດ (Inventor Name)
- (74) ຊື່ຕົວແທນ (Representative Name)
- (55) ຮ ບພາບ (Pictures)

# ພາກທີ I (Part I)

## ສິດທິບັດ ແລະ ອະນຸສິດທິບັດ (Patent and Petty Patent)

### 2. ຜົນການອອກສິດທິບັດ ແລະ ອະນຸສິດທິບັດ (Grant of Patents and Petty Patents)

#### ຄໍາອະທິບາຍກ່ຽວກັບລະຫັດຫຍໍ້ (Introduction of Codes)

- (11) ເລກທີ (Grant Number)
- (21) ເລກທີ ຄໍາຮ້ອງ (Filing Number)
- (22) ວັນທີຍືນຄໍາຮ້ອງ (Filing Date)
- (30) ວັນທີ ບ ລິມະສິດ (Priority Date)
- (43) ວັນທີເຜີຍແຜ່ (Publication Date)
- (51) ໝວດ (International Patent Classification)
- (54) ຫົວຂໍ້ ການປະດິດ (Title)
- (57) ບົດຄັດຫຍໍ້ (Abstract)
- (71) ຊື່ ແລະ ທີ່ຢ ບໍ ເຈົ້າຂອງສິດທິບັດ ແລະ ອະນ ສິດທິບັດ (Owner Name and Address)
- (72) ຊື່ຜູ້ປະດິດ (Inventor Name)
- (74) ຊື່ຕົວແທນ (Representative Name)
- (55) ຮ ບພາບ (Pictures)

Official Gazette of Industrial Property Vol. 199, 24/03/2023

- (11) No. 162
- (21) PA 162
- (22) 27/10/2011
- (30)
- (43)
- (51) Int.Cl.H 04S 3/00, G 10L 19/00
- (54) AUDIO DECODER AND DECODING METHOD USING EFFICIENT DOWNMIXING
- (57) A method, an apparatus, a computer readable storage medium configured with instructions for carrying out a method, and logic encoded in one or more computer readable tangible medium to carry out actions. The method is to decode audio data that includes N.n channels, including unpacking metadata and unpacking and decoding frequency domain exponent and mantissa data; determining transform coefficients from the unpacked and decoded frequency domain exponent and mantissa data; inverse transforming the frequency domain data; and in the case M.
- (71) DOLBY LABORATORIES LICENSING CORPORATION  
1275 Market Street, San Francisco, California 94103, United States Of America  
DOLBY INTERNATIONAL AB  
Mr. Treublaan 7 1097DP Amsterdam, Netherlands.
- (72) THESING, Robin; SILVA, James M and ANDERSEN, Robert L.
- (74) ACTIP (LAO) IP CO., LTD.
- (55)

Official Gazette of Industrial Property Vol. 199, 24/03/2023

- (11) No. 200
- (21) PA 200
- (22) 29/06/2012
- (30) 2010-000194 04/01/2010 JP
- (43)
- (51) Int.C1.8A 01N 55/00, A 01N 43/42, A 01P 3/00, C 07D 215/38, C 07D 221/04, C 07D 401/12, C 07D 471/04, C 07D 491/048, C 07D 495/04, C 07D 215/18, C 07D 215/14, C 07D 215/20
- (54) NITROGEN-CONTAINING HETEROCYCLIC COMPOUND AND AGRICULTURAL FUNGICIDE
- (57) Provided is an agricultural fungicide that contains at least one selected from the group consisting of a novel nitrogen-containing heterocyclic compound represented by Formula (I), a salt thereof, or an N-oxide compound thereof. In Formula (I), R represents a group represented by CR<sub>1</sub>R<sub>2</sub>R<sub>3</sub> or a cyano group. R<sub>1</sub> to R<sub>3</sub> each independently represents a hydrogen atom, an unsubstituted or substituted C<sub>1</sub>-8 alkyl group, an unsubstituted or substituted hydroxyl group, or the like. R<sub>4</sub> or R<sub>5</sub> represents a halogeno group or the like. Y or Z represents a carbon atom or the like, and A or D represents a benzene ring or the like. X represents an oxygen atom or a nitrogen atom or the like.
- (71) NIPPON SODA CO., LTD.  
2-1, Ohtemachi 2-chome Chiyoda-ku, Tokyo 100-8165, Japan.
- (72) SHIBAYAMA Kotaro; INAGAKI Jun; SAIKI Yuto; MITANI Akira; KUWAHARA Raito; SATO Motoaki; NISHIMURA Satoshi and KUBOKI Mami.
- (74) Lao Trademark Agency.
- (55)

Official Gazette of Industrial Property Vol. 199, 24/03/2023

- (11) No. 239
- (21) PA 239
- (22) 19/02/2013
- (30)
- (43)
- (51) Int.C1.8A 61K 21/00, A 61K 31/7088, A 61K 47/02, A 61K 31/7125, A 61K 31/713, A 61K 31/712
- (54) OLIGONUCLEOTIDE CHELATE COMPLEXES
- (57) The present disclosure describes the broadly active chelation of divalent 2+ metal cations by any oligonucleotide(ON), re-gardless of size or modifiانتion. This chelation effect is specific to cations which are divalent (or of higher valency) and results in the formation of oligonucleotide chelate complexes which do not behave like salts. It is described herein a novel composition of an ON chelate complex prepared using any ON and a divalent metal cation and methods for the suppression of anti-coagulation and or subcutaneous injection site reactions and or improved tolerability with oligonucleotides by the use of ON chelate complexes during oligonucleotide administration.
- (71) REPLICOR INC.  
6100 Royalmount Avenue, Suite D-101, Montreal, Quebec H4P 2R2, Canada.
- (72) Andrew VAILLANT and Michel BAZINET.
- (74) Lao Trademark Agency.
- (55)

- (11) No. 293
- (21) PA 293
- (22) 12/12/2013
- (30)
- (43)
- (51) Int.C1.8C 10G 3/00
- (54) A METHOD FOR PREPARING FUEL BY USING BIOLOGICAL OILS AND FATS
- (57) A new method of producing fuel from biological oils and fats is provided, which comprises following steps: (a) proceeding with a catalytic cracking-deoxygenation reaction for the biological oils and fats under heating in the presence of a cracking-deoxygenation catalyst; (b) mixing the product of step (a) with hydrogen gas; and (c) proceeding with a catalytic hydrodeoxygenation reaction for the mixture from step (b) under heating in the presence of a hydrodeoxygenation catalyst. By means of the method of the present invention, clean fuel produced by using biological oils and fats as raw materials is compatible to the fuel composition produced from crude oil refining.
- (71) 1. ECO ENVIRONMENT ENERGY RESEARCH INSTITUTE LIMITED  
23/F, 363 Java Road, North Point, Hong Kong  
2. DALIAN UNIVERSITY OF TECHNOLOGY  
No. 2 Linggong Road, Ganjongzi District, Dalian City, Liaoning Province, people Republic of China.
- (72) LIANG, Changhai; XU, Bin; SIU, Philip; WANG, Lei; CHEN, Xiao; SHAO, Zhengfeng and XIAO, Zihui.
- (74) LAO INTERCONSULT CO., LTD.
- (55)

Official Gazette of Industrial Property Vol. 199, 24/03/2023

- (11) No. 324
- (21) PA 324
- (22) 12/08/2014
- (30)
- (43)
- (51) Int.C1.8A 61M 15/00
- (54) IMPROVEMENTS RELATING TO MEDICAMENT DELIVERY DEVICES
- (57) A medicament delivery device (I) comprises a metering member (25) mounted for rotation adjacent to a reservoir (22) containing a bulk quantity of medicament. The metering member (25) is adapted when at a filling position to volumetrically meter a desired dose of medicament from the reservoir (22). By rotation of the metering member (25) in the first sense said dose is transferred to a dispensing position at which the dose can be dispensed from the device (1). The metering member (25) and/or a component (90) to which the metering member (25) is operably linked is provided with formations (95) effective to prevent reverse rotation of the metering member (25) from the filling position.
- (71) INNOVATA BIOMED LIMITED  
2nd Floor North, Saltire Court 20 Castle Terrace, Edinburgh EH1 2EN, United Kingdom.
- (72) PARKES, Philip Carl.
- (74) LAO TRADEMARK AGENCY (LAO IP AGENCY).
- (55)



Official Gazette of Industrial Property Vol. 199, 24/03/2023

- (11) No. 349
- (21) PA 349
- (22) 11/02/2015
- (30)
- (43)
- (51) Int.C1.6A 61K 31/712, A 61K 31/519, A 61K 31/7088, A 61K 31/7115, A 61K 47/48, A 61K 31/713, A 61K 38/17, A 61K 38/21, A 61P 31/14
- (54) METHODS FOR THE TREATMENT OF HEPATITIS B AND HEPATITIS D INFECTIONS
- (57)
- (71) REPLICOR INC  
Suite D-101, 6100 Royalmount Avenue, Nontreal, Quebec H4p 2R2 (CA), Canada.
- (72) BAZINET, Michel and VAILLANT, Andrew.
- (74) CONCETTI-LAO CO., LTD.
- (55)

- (11) No. 367
- (21) PA 367
- (22) 18/05/2015
- (30)
- (43)
- (51) Int.CI.8G 07C 15/00
- (54) BALL WHIRLING DEVICE FOR RECREATIONAL GAMES OF CHANCE
- (57) The invention consists in eliminating the central inner shaft of the drum in order to allow a more homogeneous mixing of the balls such that the chances of the ball being a winning ball are not dependent on the position that they may occupy before the drum is rotated. To that end, the ball-mixing blades (9) are integrally attached to the inner face of the structure of the drum. Not only does this structure allow mixing the balls better, but it also simplifies maintenance work on the device, in that it includes respective outer shafts (3) that are easily accessible without having to disassemble the drum in the event that the pin that links it with the mechanism for driving the rotation of the drum breaks.
- (71) PROINDUMAR, S.L  
Plaza de Cronos 4, 28037 Madrid , SPAIN, Spain  
Jesus Franco Munoz  
Plaza de Cronos 4, 28037 Madrid,SPAIN, Spain.
- (72) Jesus Franco Munoz.
- (74) Lao Trademark Agency.
- (55)

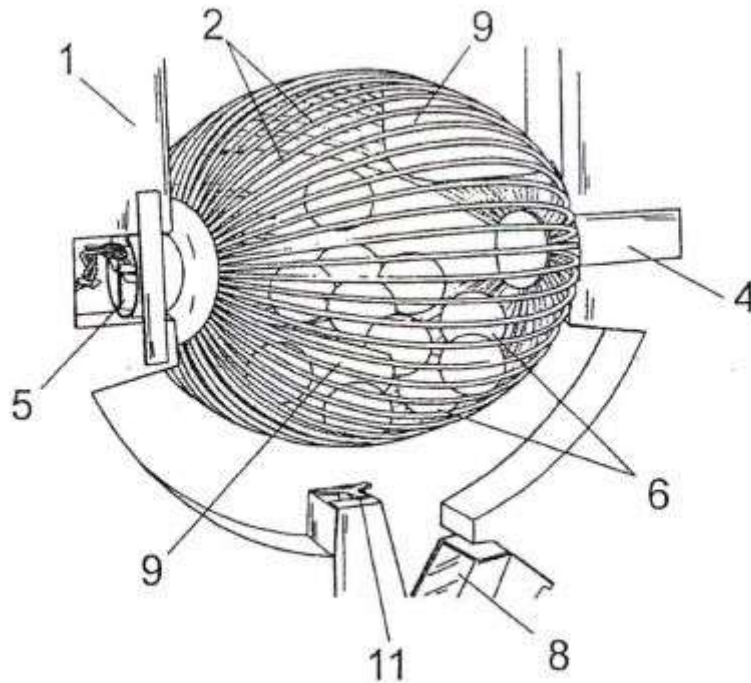
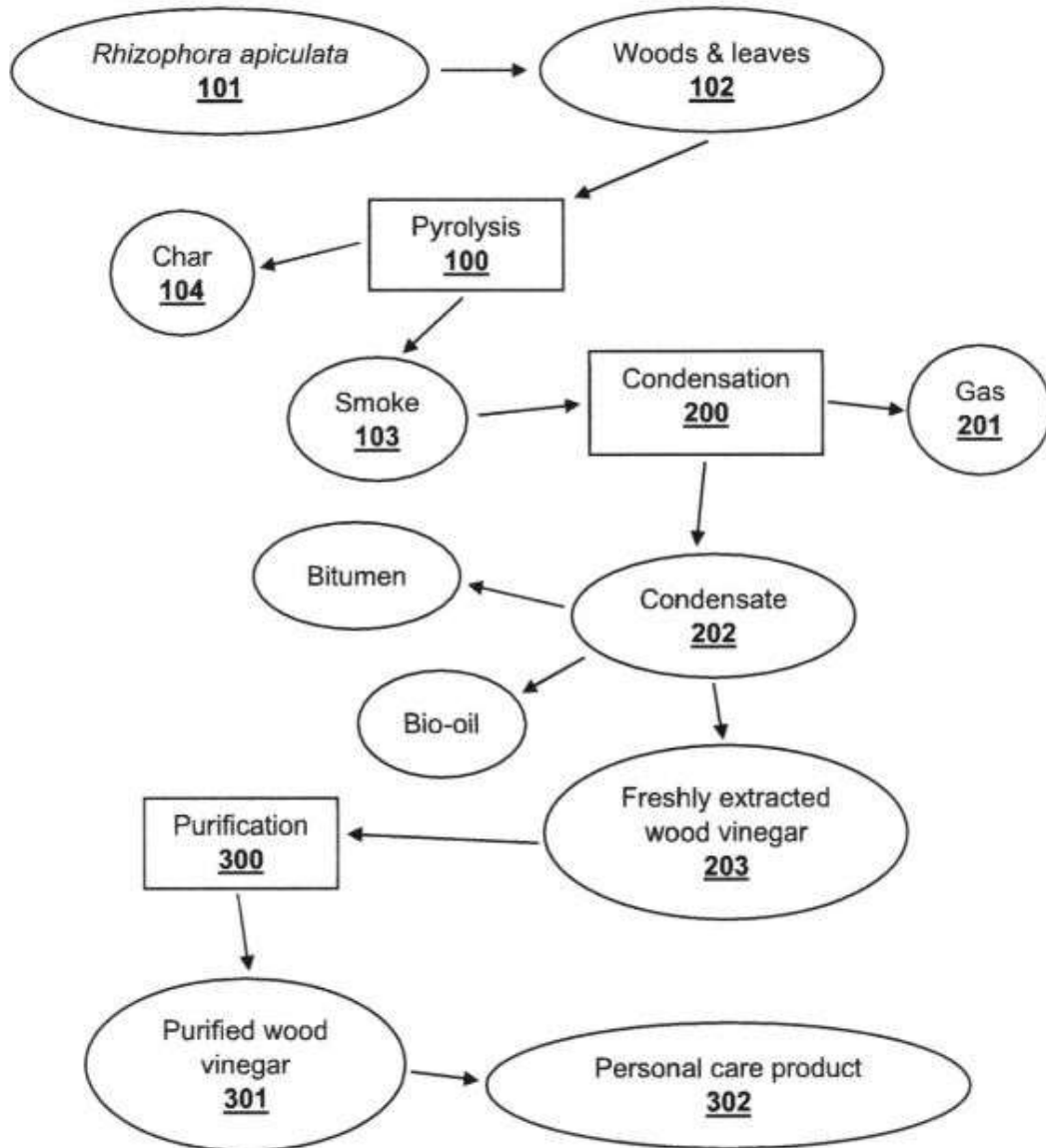

FIG. 1

Official Gazette of Industrial Property Vol. 199, 24/03/2023

- (11) No. 741
- (21) PA 741
- (22) 10/11/2020
- (30)
- (43)
- (51) Int.Cl. A 61K 36/00(2006.01), A 61P 31/02(2006.01), A 61Q 13/00(2006.01), A 61Q 5/00(2006.01), A 61Q 1/00(2006.01)
- (54) HYGIENE WASH
- (57) The present invention provides a method for preparing a personal care product (302), comprising steps of obtaining a wood vinegar (203, 301) and adding the wood vinegar (203, 301) into the personal care product (302) so that the purified wood vinegar (301) makes up 18–22% of the total weight or volume of the personal care product. The wood vinegar (203, 301) is obtained by pyrolysis (100) of woods and leaves (102) from *Rhizophora apiculata* (101), wherein the wood vinegar (301) inactivates or kills microorganisms that cause skin and urinary tract infections but retains a substantial amount of beneficial microorganisms. The wood vinegar (203, 301) is obtained without having guaiacol.
- (71) DIAMOND STAR GLOBAL SDN. BHD  
Lot 3734, Tupai Light Industrial Area, Taiping, Perak, 34000, Malaysia, Malaysia.
- (72) CHONG KWIK, Chuah and SHIN SIONG, Loh.
- (74) Agless Lao Sole Co. Ltd.
- (55)



រូបរាង 1

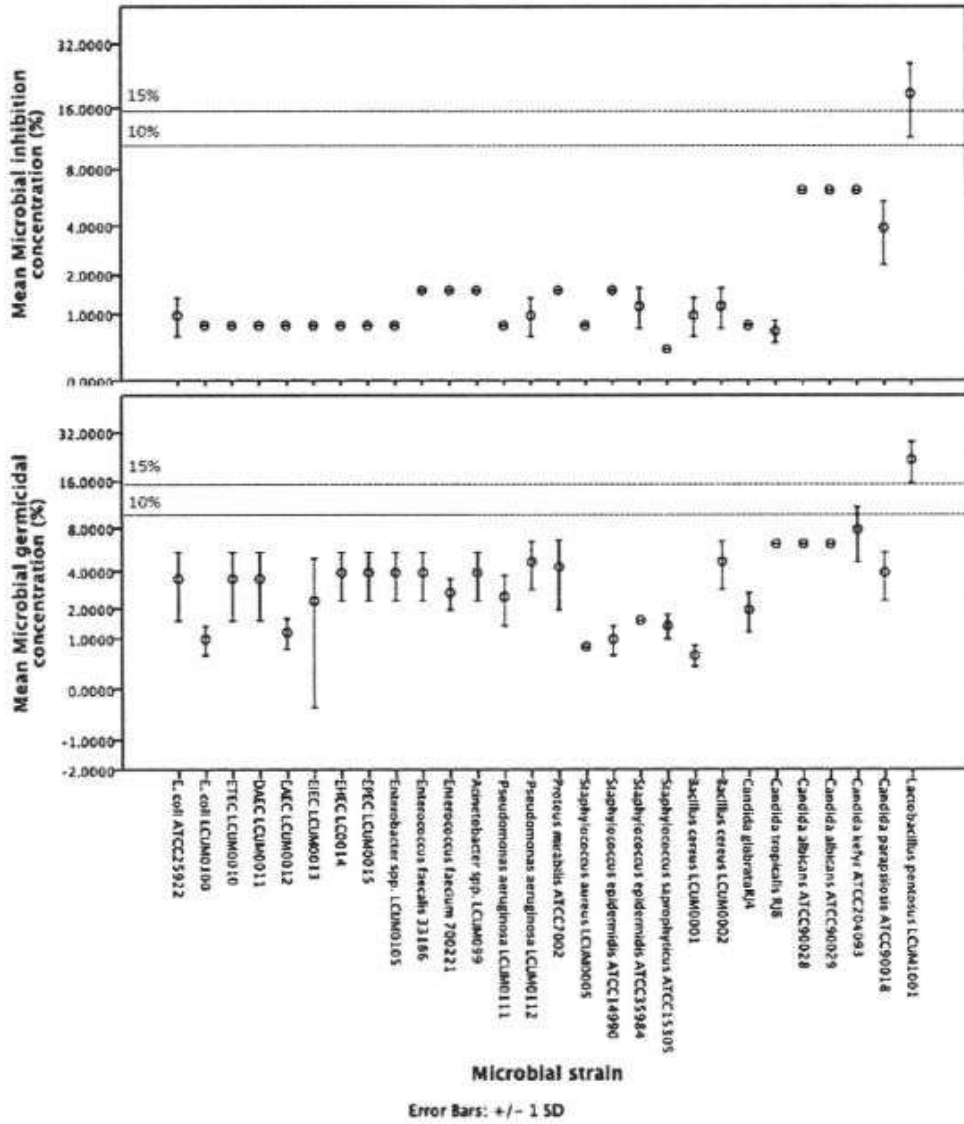

រូបພាບທີ 2

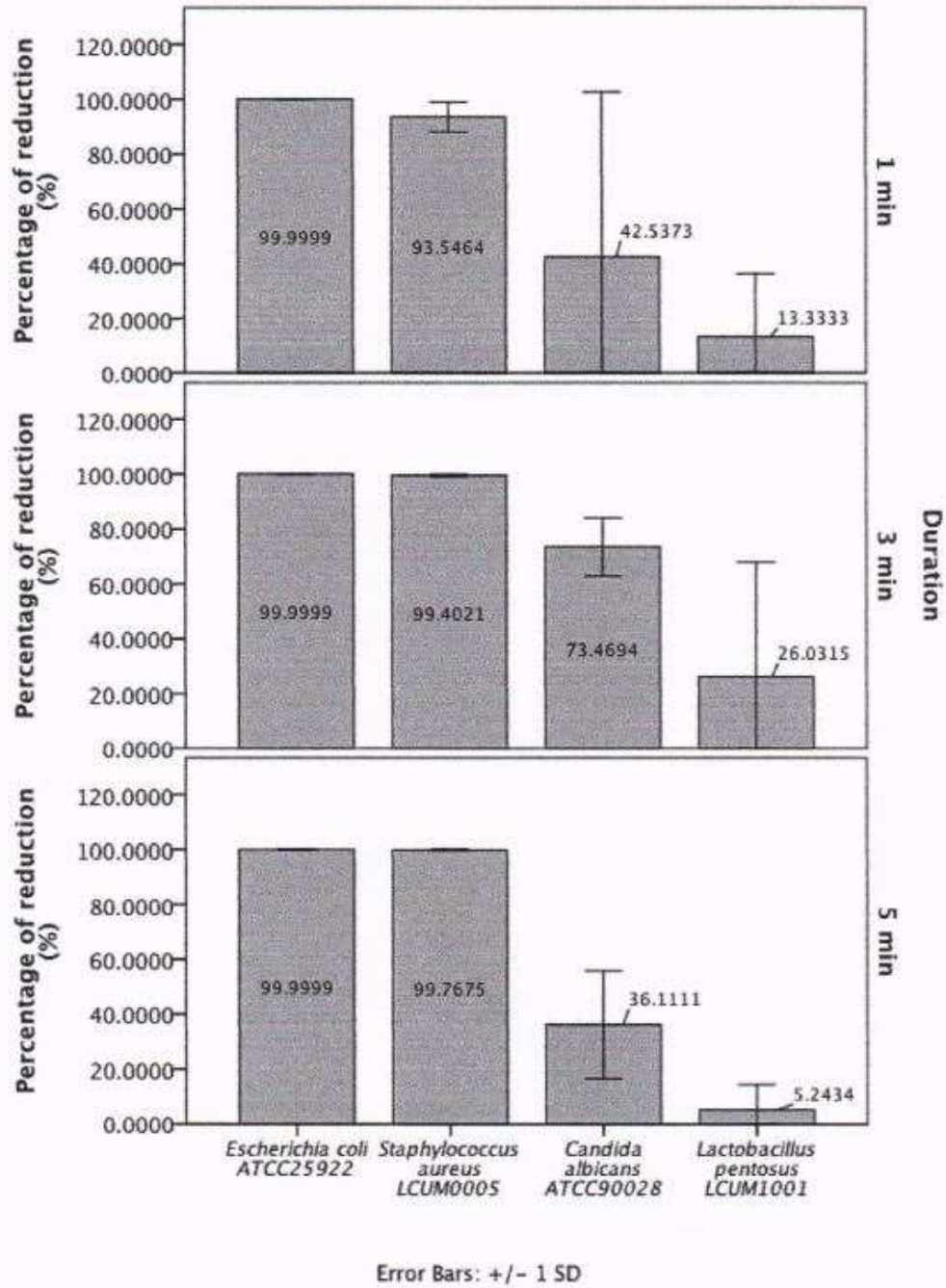

ຮູບພາບທີ 3

**ພາກທີ I**

**(Part I)**

**ສິດທິຂັດ ແລະ ອະນຸສິດທິຂັດ**

**(Patent and Petty Patent)**

**3. ການປ່ຽນແປງ**

**(Changes)**

**ພາກທີ I**

**(Part I)**

**ສິດທິບັດ ແລະ ອະນຸສິດທິບັດ**

**(Patent and Petty Patent)**

**4. ການດັດແກ້**

**(Amendments)**



**ພາກທີ II**  
**(Part II)**  
**ແບບອຸດສາຫະກຳ**  
**(Industrial Design)**

**1. ຄຳຮ້ອງ**  
**(Applications)**

**ຄຳອະທິບາຍກ່ຽວກັບລະຫັດຫຍໍ້**  
**(Introduction of Codes)**

- (21) ເລກທີ ຄຳຮ້ອງ (Filing Number)
- (22) ວັນທີ ຄຳຮ້ອງ (Filing Date)
- (30) ວັນທີ ບ ລິມາສິດ (Priority Date)
- (51) ໝວດ (Locarno Classification)
- (54) ຊື່ຂອງແບບອ ດສາຫະກຳ (Title)
- (71) ຊື່ ແລະ ທີ່ຢ ບໍ ຂອງເຈົ້າຂອງ (Owner Name and Address)
- (72) ຊື່ຜູ້ອອກແບບ (Designer Name)
- (74) ຊື່ຕົວແທນ (Representative Name)
- (55) ຮ ບພາບ (Pictures)

## ພາກທີ II

### (Part II)

## ແບບອຸດສາຫະກຳ (Industrial Design)

### 2. ຜົນການຈົດທະບຽນ (Registration)

#### ຄຳອະທິບາຍກ່ຽວກັບລະຫັດຫຍໍ້ (Introduction of Codes)

- (11) ເລກທີ ຈົດທະບຽນ (Registration Number)
- (15) ວັນທີ ຈົດທະບຽນ (Registration Date)
- (21) ເລກທີ ຍືນຄຳຮ້ອງ (Filing Number)
- (22) ວັນທີ ຍືນຄຳຮ້ອງ (Filing Date)
- (30) ວັນທີ ບ ລິມາສິດ (Priority Date)
- (17) ວັນທີ ໝົດອາຍ (Expiration Date)
- (51) ໝວດ (Locarno Classification)
- (54) ຊື່ຂອງແບບອ ຸດສາຫະກຳ (Title)
- (71) ຊື່ ແລະ ທີ່ຢ ບໍ ຂອງເຈົ້າຂອງ (Owner Name and Address)
- (72) ຊື່ຜ ັອອກແບບ (Designer Name)
- (74) ຊື່ຕົວແທນ (Representative Name)
- (55) ຮ ບພາບ (Pictures)

**ພາກທີ II**

**(Part II)**

**ແບບອຸດສາຫະກຳ  
(Industrial Design)**

**3. ການປ່ຽນແປງ**

**(Changes)**

**ພາກທີ II**  
**(Part II)**

**ແບບອຸດສາຫະກຳ**  
**(Industrial Design)**

**4. ການດັດແກ້**  
**(Amendments)**

## ພາກທີ III

### (Part III)

## ເຄື່ອງໝາຍການຄ້າ

### Trademarks

#### 1. ຄໍາຮ້ອງ

#### (Applications)

#### ຄໍາອະທິບາຍກ່ຽວກັບລະຫັດຫຍໍ້

#### (Introduction of Codes)

- (540) ເຄື່ອງໝາຍການຄ້າ (Trademark)
- (511) ໝວດ (Nice Classification)
- (210) ເລກທີ ຄໍາຮ້ອງ (Number of the application)
- (220) ວັນທີ ຄໍາຮ້ອງ (Date of filing of the application)
- (732) ຊື່ ແລະ ທີ່ຢ ບໍ ຂອງຜູ້ຍື່ນຄໍາຮ້ອງ (Name and Address of applicant)

( 540 )



(511) 09

(210) No. 47513

(220) 12/10/2022

(732) TIANCHANG ZHIYUN E-COMMERCE  
CO., LTD.

LULONG VILLAGE STREET, LULONG  
TOWNSHIP, TIANCHANG CITY, 239300  
CHINA.

( 540 )

The logo is the text 'inphic' in a lowercase, serif font. The letters are black and have a classic, slightly condensed appearance.

(511) 09

(210) No. 47595

(220) 02/11/2022

(732) Shenzhen Yingfei Ke Electronics Co., Ltd.

Room 2405, 24th Floor, Jinhua Building,  
Longfeng 3rd Road, Dalang Street, Longhua  
District Shenzhen, China.

( 540 )



(511) 31

(210) No. 47607

(220) 02/11/2022

(732) Pet Protect Food Co., Ltd.

2/1 Phaholyothin Road, Phaholyothin 29,  
Chatuchak, Bangkok, Thailand.

( 540 )



(511) 09, 35, 38, 39, 42 and 43

(210) No. 47631

(220) 11/11/2022

(732) ບໍລິສັດ ອີ-ເກັສ ( ລາວ ) ເທັກໂນໂລຊີ ຈຳກັດ

ບ້ານ: ນາຄຳ, ເມືອງ: ສີໂຄດຕະບອງ,  
ນະຄອນຫຼວງວຽງຈັນ, ສປປ ລາວ

( 540 )

STING LIFE SWITCHED ON

(511) 32

(210) No. 47635

(220) 14/11/2022

(732) PepsiCo, Inc.

700 Anderson Hill Road, Purchase, New  
York 10577, United States of America.

( 540 )



(511) 07

(210) No. 47638

(220) 15/11/2022

(732) ZHEJIANG ZHIGAO MACHINERY CO.,  
LTD

No.15 Bailing North Avenue Qujiang  
Economic Development Zone, Quzhou City  
Zhengjiang Provice, China.



( 540 )

**Mum-Mum**

(511) 30

(210) No. 47639

(220) 15/11/2022

(732) I LAN FOODS IND. CO., LTD.

No.13, Xincheng Rd., Su'ao Township, Yilan  
County, Taiwan (R.O.C.)

( 540 )

**QQ  
GUMMI**

(511) 30

(210) No. 47640

(220) 15/11/2022

(732) I LAN FOODS IND. CO., LTD.

No.13, Xincheng Rd., Su'ao Township, Yilan  
County, Taiwan (R.O.C.).

( 540 )



(511) 12 and 35

(210) No. 47643

(220) 16/11/2022

(732) ບໍລິສັດ ຊວນອີ້ ຈຳກັດ

ບ້ານ ຄຳຮຸ່ງ, ເມືອງໄຊທານີ, ນະຄອນຫຼວງວຽງຈັນ,  
ສປປ ລາວ

( 540 )



(511) 32

(210) No. 47689

(220) 28/11/2022

(732) Eastroc Beverage Group Co., Ltd.

1 floor, Block 3, Zhong Guan Honghualing  
Industrial West Zone, No. 142 Zhuguang  
North Road, Taoyuan Street, Nanshan  
District, Shenzhen, Guangdong Province,  
China.

( 540 )

**Panasahlc**

(511) 09

(210) No. 47701

(220) 05/12/2022

(732) ZHEJIANG AOMA PUMP INDUSTRIAL  
CO., LTD.

Injection Molding Park of Daxi

Town, Wenling City, 317500, China.

( 540 )

**TSOLOT**

(511) 07

(210) No. 47702

(220) 05/12/2022

(732) ZHEJIANG AOMA PUMP INDUSTRIAL  
CO., LTD.

Injection Molding Park of Daxi Town,

Wenling City, 317500, China.

( 540 )

The logo for VaySunic features the word "VaySunic" in a bold, black, sans-serif font. The letter "V" is enclosed within a circular graphic element that resembles a stylized eye or a lens.

(511) 09

(210) No. 47716

(220) 08/12/2022

(732) WUXI VAYSUNIC NEW ENERGY  
TECHNOLOGY CO., LTD

No. 28, Jianhong Road, Xinwu District, Wuxi  
City, China.

( 540 )



(511) 34 and 35

(210) No. 47722

(220) 08/12/2022

(732) SSKP LOGISTICS COMPANY LIMITED  
AND RAINBOW STAR COMPANY  
LIMITED

No.999/16-17, Mu 15 Bang Sao Thong Sub-  
district, Bang Sao Thong District, Samut  
Prakan Province Thailand and No. 184, Mu 1,  
Chehe Sub-district, Tak Bai District,  
Narathiwat Province, Thailand.

( 540 )



(511) 34 and 35

(210) No. 47723

(220) 08/12/2022

(732) SSKP LOGISTICS COMPANY LIMITED  
AND RAINBOW STAR COMPANY  
LIMITED

No.999/16-17, Mu 15, Bang Sao Thong Sub-  
district, Bang Sao Thong District, Samut  
Prakan Province Thailand and No. 184, Mu 1,  
Chehe Sub-district, Tak Bai District,  
Narathiwat Province, Thailand.

( 540 )

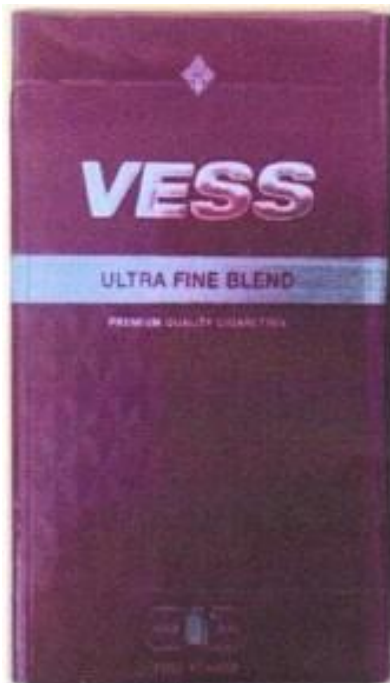

(511) 34 and 35

(210) No. 47724

(220) 08/12/2022

(732) SSKP LOGISTICS COMPANY LIMITED  
AND RAINBOW STAR COMPANY  
LIMITED

No. 999/16-17, Mu 15, Bang Sao Thong Sub-  
district, Bang Sao Thong District, Samut  
Prakan Province Thailand and No. 184, Mu 1,  
Chehe Sub-district, Tak Bai District,  
Narathiwat Province, Thailand.

( 540 )

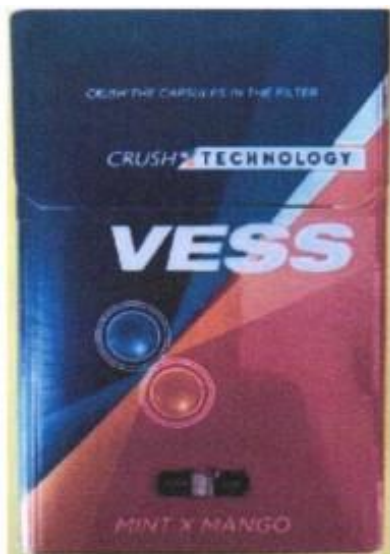

(511) 34 and 35

(210) No. 47725

(220) 08/12/2022

(732) SSKP LOGISTICS COMPANY LIMITED  
AND RAINBOW STAR COMPANY  
LIMITED

No, 999/16-17, Mu 15 Bang Sao Thong Sub-  
district, Bang Sao Thong District, Samut  
Prakan Province Thailand and No. 184, Mu 1,  
Chehe Sub-district, Tak Bai District,  
Narathiwat Province, Thailand.

( 540 )



(511) 01 and 17

(210) No. 47741

(220) 15/12/2022

(732) SEALEX CHEMICAL Co., Ltd.

22/8, Moo No. 7, Khlong Si Sub-district,  
Khlong Luang District, Pathum Thani  
Province, 12120, Thailand.

( 540 )



(511) 29

(210) No. 47758

(220) 21/12/2022

(732) Guangzhou Dongchen International Trade Co., Ltd.

Room 103, 1st Floor, No. 348, Longjiao Road, Shijing Avenue, Baiyun Lake Street, Baiyun District, Guangzhou, China.

( 540 )



(511) 30

(210) No. 47759

(220) 21/12/2022

(732) Guangzhou Dongchen International Trade Co., Ltd.

Room 103, 1st Floor, No. 348, Longjiao Road, Shijing Avenue, Baiyun Lake Street, Baiyun District, Guangzhou, China.

( 540 )



(511) 32

(210) No. 47760

(220) 21/12/2022

(732) Guangzhou Dongchen International Trade Co., Ltd.

Room 103, 1st Floor, No. 348, Longjiao Road, Shijing Avenue, Baiyun Lake Street, Baiyun District, Guangzhou, China.

( 540 )



(511) 35

(210) No. 47761

(220) 21/12/2022

(732) Guangzhou Dongchen International Trade Co., Ltd.

Room 103, 1st Floor, No. 348, Longjiao Road, Shijing Avenue, Baiyun Lake Street, Baiyun District, Guangzhou, China.



( 540 )



(511) 43

(210) No. 47762

(220) 21/12/2022

(732) Guangzhou Dongchen International Trade Co., Ltd.

Room 103, 1st Floor, No. 348, Longjiao Road, Shijing Avenue, Baiyun Lake Street, Baiyun District, Guangzhou, China.

( 540 )



(511) 34 and 35

(210) No. 47772

(220) 27/12/2022

(732) SSKP LOGISTICS COMPANY LIMITED AND RAINBOW STAR COMPANY LIMITED

No. 999/16-17, Mu 15, Bang Sao Thong Sub-district, Bang Sao Thong District, SamutPrakan Province Thailand and No, 184, Mu 1, Chehe Sub-district, Tak Bai District, Narathiwat Province, Thailand.

( 540 )



(511) 34 and 35

(210) No. 47773

(220) 27/12/2022

(732) SSKP LOGISTICS COMPANY LIMITED  
AND RAINBOW STAR COMPANY  
LIMITED

No. 999/16-17, Mu 15, Bang Sao Thong Sub-  
district, Bang Sao Thong District,  
SamutPrakan Province Thailand and No. 184,  
Mu 1, Chehe Sub-district, Tak Bai District,  
Narathiwat Province, Thailand.

## ພາກທີ III

### (Part III)

## ເຄື່ອງໝາຍການຄ້າ

### Trademarks

#### 2. ຜົນການຈົດທະບຽນ

##### (Registration)

##### ຄຳອະທິບາຍກ່ຽວກັບລະຫັດຫຍໍ້

##### (Introduction of Codes)

- (540) ເຄື່ອງໝາຍການຄ້າ (Trademark)
- (511) ໝວດ (Nice Classification)
- (210) ເລກທີ ຄຳຮ້ອງ (Number of the application)
- (220) ວັນທີ ຄຳຮ້ອງ (Date of filing of the application)
- (732) ຊື່ ແລະ ທີ່ຢ ບໍ ຂອງຜູ້ຍື່ນຄຳຮ້ອງ (Name and Address of applicant)
- (111) ເລກທີ ການຈົດທະບຽນເຄື່ອງໝາຍການຄ້າ (Number of the registration)
- (180) ວັນໝົດອາຍ ຂອງການຈົດທະບຽນ (Expiration date of the registration)

( 540 )



(511) 16

(210) No. 44878

(220) 24/08/2020

(732) BEERCO LIMITED

438 Alexandra Road, #05-01 Alexandra  
Point, 119958, Singapore

(111) No. 56573

(180) 24/08/2030

( 540 )



(511) 32

(210) No. 44879

(220) 24/08/2020

(732) BEERCO LIMITED

438 Alexandra Road, #05-01 Alexandra  
Point, 119958, Singapore

(111) No. 56574

(180) 24/08/2030

( 540 )



(511) 35

(210) No. 44880

(220) 24/08/2020

(732) BEERCO LIMITED

438 Alexandra Road, #05-01 Alexandra  
Point, 119958, Singapore

(111) No. 56575

(180) 24/08/2030

( 540 )



(511) 36

(210) No. 44881

(220) 24/08/2020

(732) BEERCO LIMITED

438 Alexandra Road, #05-01 Alexandra  
Point, 119958, Singapore

(111) No. 56576

(180) 24/08/2030

( 540 )



(511) 30

(210) No. 44713

(220) 06/07/2020

(732) SAMYANG FOOD CO., LTD.

104, Opaesan-ro 3-gil, Seongbuk-gu, Seoul,  
Republic Of Korea

(111) No. 56577

(180) 06/07/2030

( 540 )



(511) 35 and 37

(210) No. 46367

(220) 02/11/2021

(732) SCG Ceramics Public Company Limited

1 Siam Cement Road, Bangsue Sub-district,  
Bangsue District, Bangkok 10800, Thailand

(111) No. 56580

(180) 02/11/2031

( 540 )



(511) 35 and 37

(210) No. 46368

(220) 02/11/2021

(732) SCG Ceramics Public Company Limited  
1 Siam Cement Road, Bangsue Sub-district,  
Bangsue District, Bangkok 10800, Thailand

(111) No. 56581

(180) 02/11/2031

( 540 )



(511) 35 and 37

(210) No. 46369

(220) 02/11/2021

(732) SCG Ceramics Public Company Limited  
1 Siam Cement Road, Bangsue Sub-district,  
Bangsue District, Bangkok 10800, Thailand

(111) No. 56582

(180) 02/11/2031

( 540 )

**APPO**

(511) 09 and 11

(210) No. 46448

(220) 23/11/2021

(732) Appotronics Corporation Limited.

20F-22F, High-Tech Zone Union Torver,

No.63 Xuefu Road, Nanshan District,

Shenzhen, Guangdong, China

(111) No. 56583

(180) 23/11/2031

( 540 )



(511) 30

(210) No. 47247

(220) 02/08/2022

(732) S.B. FOOD COMPANY LIMITED

No. 139, Mu 6, Ban Bueng-Klaeng Road,

Wang Chan Sub-district, Wang Chan District,

Rayong Province, Thailand

(111) No. 56602

(180) 02/08/2032



( 540 )



(511) 30

(210) No. 47248

(220) 02/08/2022

(732) S.B. FOOD COMPANY LIMITED

No. 139, Mu 6, Ban Bueng-Klaeng Road,  
Wang Chan Sub-district, Wang Chan District,  
Rayong Province, Thailand

(111) No. 56603

(180) 02/08/2032

( 540 )

**Comfrey**

(511) 05

(210) No. 47250

(220) 02/08/2022

(732) HANGZHOU HAOYUE PERSONAL CARE  
CO., LTD.

NO.655 HONGFENG ROAD, YUHANG  
ECONOMIC AND TECHNOLOGICAL  
DEVELOPMENT ZONE, HANGZHOU  
CITY, ZHEJIANG PROVINCE, CHINA

(111) No. 56604

(180) 02/08/2032

( 540 )



(511) 09

(210) No. 47251

(220) 02/08/2022

(732) Hozon New Energy Automobile Co., Ltd.  
No. 988, Tongren Road, Wutong Street,  
Tongxiang City, Jiaxing City, Zhejiang  
Province, China

(111) No. 56605

(180) 02/08/2032

( 540 )



(511) 12

(210) No. 47252

(220) 02/08/2022

(732) Hozon New Energy Automobile Co., Ltd.  
No. 988, Tongren Road, Wutong Street,  
Tongxiang City, Jiaxing City, Zhejiang  
Province, China

(111) No. 56606

(180) 02/08/2032

( 540 )



(511) 30

(210) No. 47315

(220) 04/08/2022

(732) INTERNATIONAL FOODSTUFFS CO.  
LLC

AL-WAHDA STREET, INDUSTRIAL  
AREA NO. 1, P.O. BOX 4115, SHARJAH,  
UNITED ARAB EMIRATES

(111) No. 56607

(180) 04/08/2032

( 540 )



(511) 35

(210) No. 47253

(220) 02/08/2022

(732) Hozon New Energy Automobile Co., Ltd.  
No. 988, Tongren Road, Wutong Street,  
Tongxiang City, Jiaxing City, Zhejiang  
Province, China

(111) No. 56608

(180) 02/08/2032

( 540 )

NETA

(511) 09

(210) No. 47254

(220) 02/08/2022

(732) Hozon New Energy Automobile Co., Ltd.  
No. 988, ongren Road, Wutong Street,  
Tongxiang City, Jiaxing City, Zhejiang  
Province, China

(111) No. 56609

(180) 02/08/2032

( 540 )

NETA

(511) 12

(210) No. 47255

(220) 02/08/2022

(732) Hozon New Energy Automobile Co., Ltd.  
No. 988, Tongren Road, Wutong Street,  
Tongxiang City, Jiaxing City, Zhejiang  
Province, China

(111) No. 56610

(180) 02/08/2032

( 540 )

The logo consists of the word "NETA" in a bold, black, sans-serif font. The letters are widely spaced and have a slightly irregular, hand-drawn appearance.

(511) 35

(210) No. 47256

(220) 02/08/2022

(732) Hozon New Energy Automobile Co., Ltd.  
No. 988, Tongren Road, Wutong Street,  
Tongxiang City, Jiaxing City, Zhejiang  
Province, China

(111) No. 56611

(180) 02/08/2032

( 540 )



(511) 34

(210) No. 47257

(220) 02/08/2022

(732) Jilin Tobacco Industry Co., Ltd.  
No. 795, Tianchi Road, Yanji City, Jilin,  
China

(111) No. 56612

(180) 02/08/2032

( 540 )



(511) 34

(210) No. 47258

(220) 02/08/2022

(732) Jilin Tobacco Industry Co. Ltd.

No. 795, Tianchi Road, Yanji City, Jilin,  
China

(111) No. 56613

(180) 02/08/2032

( 540 )



(511) 20

(210) No. 47261

(220) 03/08/2022

(732) HOME PRODUCT CENTER PUBLIC  
COMPANY LIMITED

31 PRACHACHUENNONTHABURI ROAD,  
BANG KHEN SUB-DISTRICT, MUANG  
NONTHABURI DISTRICT, NONTHABURI  
PROVINCE, THAILAND

(111) No. 56614

(180) 03/08/2032

( 540 )



(511) 24

(210) No. 47262

(220) 03/08/2022

(732) HOME PRODUCT CENTER PUBLIC  
COMPANY LIMITED  
31 PRACHACHUENNONTHABURI ROAD,  
BANG KHEN SUB-DISTRICT, MUANG  
NONTHABURI DISTRICT, NONTHABURI  
PROVINCE, THAILAND

(111) No. 56615

(180) 03/08/2032

( 540 )



(511) 27

(210) No. 47263

(220) 03/08/2022

(732) HOME PRODUCT CENTER PUBLIC  
COMPANY LIMITED  
31 PRACHACHUENNONTHABURI ROAD,  
BANG KHEN SUB-DISTRICT, MUANG  
NONTHABURI DISTRICT, NONTHABURI  
PROVINCE, THAILAND

(111) No. 56616

(180) 03/08/2032

( 540 )

The logo for Furdini, featuring the word "Furdini" in a bold, white, serif font, set against a solid black rectangular background.

(511) 20

(210) No. 47264

(220) 03/08/2022

(732) HOME PRODUCT CENTER PUBLIC  
COMPANY LIMITED

31 PRACHACHUENNONTHABURI ROAD,  
BANG KHEN SUB-DISTRICT, MUANG  
NONTHABURI DISTRICT, NONTHABURI  
PROVINCE, THAILAND

(111) No. 56617

(180) 03/08/2032

( 540 )

The logo for Spring, featuring the word "Spring" in a black, serif font. A small green sprout with two leaves is positioned above the letter 'i'.

(511) 11

(210) No. 47268

(220) 03/08/2022

(732) HOME PRODUCT CENTER PUBLIC  
COMPANY LIMITED

31 PRACHACHUENNONTHABURI ROAD,  
BANG KHEN SUB-DISTRICT, MUANG  
NONTHABURI DISTRICT, NONTHABURI  
PROVINCE, THAILAND

(111) No. 56618

(180) 03/08/2032



( 540 )

The logo for 'Spring' features the word 'Spring' in a serif font. A stylized green leaf with three smaller leaves branching from it is positioned above the letter 'i'.

(511) 18

(210) No. 47269

(220) 03/08/2022

(732) HOME PRODUCT CENTER PUBLIC

COMPANY LIMITED

31 PRACHACHUENNONTHABURI ROAD,

BANG KHEN SUB-DISTRICT, MUANG

NONTHABURI DISTRICT, NONTHABURI

PROVINCE, THAILAND

(111) No. 56619

(180) 03/08/2032

( 540 )

The logo for 'Spring' features the word 'Spring' in a serif font. A stylized green leaf with three smaller leaves branching from it is positioned above the letter 'i'.

(511) 20

(210) No. 47270

(220) 03/08/2022

(732) HOME PRODUCT CENTER PUBLIC

COMPANY LIMITED

31 PRACHACHUENNONTHABURI ROAD,

BANG KHEN SUB-DISTRICT, MUANG

NONTHABURI DISTRICT, NONTHABURI

PROVINCE, THAILAND

(111) No. 56620

(180) 03/08/2032

( 540 )

**MATALI** 

(511) 06

(210) No. 47271

(220) 03/08/2022

(732) HOME PRODUCT CENTER PUBLIC  
COMPANY LIMITED

31 PRACHACHUENNONTHABURI ROAD,  
BANG KHEN SUB-DISTRICT, MUANG  
NONTHABURI DISTRICT, NONTHABURI  
PROVINCE, THAILAND

(111) No. 56621

(180) 03/08/2032

( 540 )

**MATALI** 

(511) 07

(210) No. 47272

(220) 03/08/2022

(732) HOME PRODUCT CENTER PUBLIC  
COMPANY LIMITED

31 PRACHACHUENNONTHABURI ROAD,  
BANG KHEN SUB-DISTRICT, MUANG  
NONTHABURI DISTRICT, NONTHABURI  
PROVINCE, THAILAND

(111) No. 56622

(180) 03/08/2032

( 540 )

**MATALI** 

(511) 08

(210) No. 47273

(220) 03/08/2022

(732) HOME, PRODUCT CENTER PUBLIC  
COMPANY LIMITED

31 PRACHACHUENNONTHABURI ROAD,  
BANG KHEN SUB-DISTRICT, MUANG  
NONTHABURI DISTRICT, NONTHABURI  
PROVINCE, THAILAND

(111) No. 56623

(180) 03/08/2032

( 540 )

**MATALI** 

(511) 12

(210) No. 47274

(220) 03/08/2022

(732) HOME PRODUCT CENTER PUBLIC  
COMPANY LIMITED

31 PRACHACHUENNONTHABURI ROAD,  
BANG KHEN SUB-DISTRICT, MUANG  
NONTHABURI DISTRICT, NONTHABURI  
PROVINCE, THAILAND

(111) No. 56624

(180) 03/08/2032

( 540 )

The logo for MATAL consists of the word "MATAL" in a bold, sans-serif font, followed by a square icon containing a stylized, geometric shape.

(511) 20

(210) No. 47275

(220) 03/08/2022

(732) HOME PRODUCT CENTER PUBLIC  
COMPANY LIMITED

31 PRACHACHUENNONTHABURI ROAD,  
BANG KHEN SUB-DISTRICT, MUANG  
NONTHABURI DISTRICT, NONTHABURI  
PROVINCE, THAILAND

(111) No. 56625

(180) 03/08/2032

( 540 )

The logo for ELECTA features a stylized letter 'E' inside a dark, rounded square shape. Below the graphic, the word "ELECTA" is written in a bold, sans-serif font.

(511) 11

(210) No. 47276

(220) 03/08/2022

(732) HOME PRODUCT CENTER PUBLIC  
COMPANY LIMITED

31 PRACHACHUENNONTHABURI ROAD,  
BANG KHEN SUB-DISTRICT, MUANG  
NONTHABURI DISTRICT, NONTHABURI  
PROVINCE, THAILAND

(111) No. 56626

(180) 03/08/2032

( 540 )

**Stack** 

(511) 20

(210) No. 47278

(220) 03/08/2022

(732) HOME PRODUCT CENTER PUBLIC  
COMPANY LIMITED

31 PRACHACHUENNONTHABURI ROAD,  
BANG KHEN SUB-DISTRICT, MUANG  
NONTHABURI DISTRICT, NONTHABURI  
PROVINCE, THAILAND

(111) No. 56627

(180) 03/08/2032

( 540 )

**EABIN** 

(511) 06

(210) No. 47279

(220) 03/08/2022

(732) HOME PRODUCT CENTER PUBLIC  
COMPANY LIMITED

31 PRACHACHUENNONTHABURI ROAD,  
BANG KHEN SUB-DISTRICT, MUANG  
NONTHABURI DISTRICT, NONTHABURI  
PROVINCE, THAILAND

(111) No. 56628

(180) 03/08/2032

( 540 )

The logo for EABIN, featuring the word "EABIN" in a bold, sans-serif font. The letter "E" is stylized with a 3D effect, appearing as a block with a top surface and a right side, giving it a three-dimensional appearance.

(511) 11

(210) No. 47280

(220) 03/08/2022

(732) HOME PRODUCT CENTER PUBLIC

COMPANY LIMITED

31 PRACHACHUENNONTHABURI ROAD,

BANG KHEN SUB-DISTRICT, MUANG

NONTHAB URI DISTRICT, NONTHAB

URI PROVINCE, THAILAND

(111) No. 56629

(180) 03/08/2032

( 540 )

The logo for EABIN, featuring the word "EABIN" in a bold, sans-serif font. The letter "E" is stylized with a 3D effect, appearing as a block with a top surface and a right side, giving it a three-dimensional appearance.

(511) 20

(210) No. 47281

(220) 03/08/2022

(732) HOME PRODUCT CENTER PUBLIC

COMPANY LIMITED

31 PRACHACHUENNONTHABURI ROAD,

BANG KHEN SUB-DISTRICT, MUANG

NONTHABURI DISTRICT, NONTHABURI

PROVINCE, THAILAND

(111) No. 56630

(180) 03/08/2032

( 540 )

**asle**

(511) 06

(210) No. 47282

(220) 03/08/2022

(732) HOME PRODUCT CENTER PUBLIC

COMPANY LIMITED

31 PRACHACHUENNONTHABURI ROAD,

BANG KHEN SUB-DISTRICT, MUANG

NONTHABURI DISTRICT, NONTHABURI

PROVINCE, THAILAND

(111) No. 56631

(180) 03/08/2032

( 540 )

**asle**

(511) 19

(210) No. 47283

(220) 03/08/2022

(732) HOME PRODUCT CENTER PUBLIC

COMPANY LIMITED

31 PRACHACHUENNONTHABURI ROAD,

BANG KHEN SUB-DISTRICT, MUANG

NONTHABURI DISTRICT, NONTHABURI

PROVINCE, THAILAND

(111) No. 56632

(180) 03/08/2032

( 540 )

The logo for ASLE, featuring the letters 'ASLE' in a bold, black, sans-serif font. The 'A' and 'S' are connected, and the 'L' and 'E' are also connected.

(511) 20

(210) No. 47284

(220) 03/08/2022

(732) HOME PRODUCT CENTER PUBLIC  
COMPANY LIMITED

31 PRACHACHUENNONTHABURI ROAD,  
BANG KHEN SUB-DISTRICT, MUANG  
NONTHABURI DISTRICT, NONTHABURI  
PROVINCE, THAILAND

(111) No. 56633

(180) 03/08/2032

( 540 )

The logo for PARNO, featuring a stylized icon of three dots in a triangle to the left of the word 'PARNO' in a bold, black, sans-serif font.

(511) 06

(210) No. 47285

(220) 03/08/2022

(732) HOME PRODUCT CENTER PUBLIC  
COMPANY LIMITED

31 PRACHACHUENNONTHABURI ROAD,  
BANG KHEN SUB-DISTRICT, MUANG  
NONTHABURI DISTRICT, NONTHABURI  
PROVINCE, THAILAND

(111) No. 56634

(180) 03/08/2032



( 540 )

The logo for PARNO, featuring a stylized icon of four dots in a 2x2 grid to the left of the word "PARNO" in a bold, sans-serif font.

(511) 11

(210) No. 47286

(220) 03/08/2022

(732) HOME PRODUCT CENTER PUBLIC  
COMPANY LIMITED

31 PRACHACHUENNONTHABURI ROAD,  
BANG KHEN SUB-DISTRICT, MUANG  
NONTHABURI DISTRICT, NONTHABURI  
PROVINCE, THAILAND

(111) No. 56635

(180) 03/08/2032

( 540 )

The logo for PARNO, featuring a stylized icon of four dots in a 2x2 grid to the left of the word "PARNO" in a bold, sans-serif font.

(511) 17

(210) No. 47287

(220) 03/08/2022

(732) HOME PRODUCT CENTER PUBLIC  
COMPANY LIMITED

31 PRACHACHUENNONTHABURI ROAD,  
BANG KHEN SUB-DISTRICT, MUANG  
NONTHABURI DISTRICT, NONTHABURI  
PROVINCE, THAILAND

(111) No. 56636

(180) 03/08/2032

( 540 )

The logo for PARNO, featuring a stylized icon of four dots in a 2x2 grid to the left of the word "PARNO" in a bold, sans-serif font.

(511) 19

(210) No. 47288

(220) 03/08/2022

(732) HOME PRODUCT CENTER PUBLIC

COMPANY LIMITED

31 PRACHACHUENNONTHABURI ROAD,

BANG KHEN SUB-DISTRICT, MUANG

NONTHABURI DISTRICT, NONTHABURI

PROVINCE, THAILAND

(111) No. 56637

(180) 03/08/2032

( 540 )

The logo for PARNO, featuring a stylized icon of four dots in a 2x2 grid to the left of the word "PARNO" in a bold, sans-serif font.

(511) 20

(210) No. 47289

(220) 03/08/2022

(732) HOME PRODUCT CENTER PUBLIC

COMPANY LIMITED

31 PRACHACHUENNONTHABURI ROAD,

BANG KHEN SUB-DISTRICT, MUANG

NONTHABURI DISTRICT, NONTHABURI

PROVINCE, THAILAND

(111) No. 56638

(180) 03/08/2032

( 540 )



(511) 21

(210) No. 47290

(220) 03/08/2022

(732) HOME PRODUCT CENTER PUBLIC

COMPANY LIMITED

31 PRACHACHUENNONTHABURI ROAD,

BANG KHEN SUB-DISTRICT, MUANG

NONTHABURI DISTRICT, NONTHABURI

PROVINCE, THAILAND

(111) No. 56639

(180) 03/08/2032

( 540 )



(511) 07

(210) No. 47291

(220) 03/08/2022

(732) HOME PRODUCT CENTER PUBLIC

COMPANY LIMITED

31 PRACHACHUENNONTHABURI ROAD,

BANG KHEN SUB-DISTRICT, MUANG

NONTHABURI DISTRICT, NONTHABURI

PROVINCE, THAILAND

(111) No. 56640

(180) 03/08/2032

( 540 )

**MAZDOX**

(511) 08

(210) No. 47292

(220) 03/08/2022

(732) HOME PRODUCT CENTER PUBLIC  
COMPANY LIMITED

31 PRACHACHUENNONTHABURI ROAD,  
BANG KHEN SUB-DISTRICT, MUANG  
NONTHABURI DISTRICT, NONTHABURI  
PROVINCE, THAILAND

(111) No. 56641

(180) 03/08/2032

( 540 )

**BEAR POWER**

(511) 30

(210) No. 47296

(220) 04/08/2022

(732) INTERNATIONAL FOODSTUFFS CO.  
LLC

AL-WAHDA STREET, INDUSTRIAL  
AREA NO. 1, P.O. BOX 4115, SHARJAH,  
UNITED ARAB EMIRATES

(111) No. 56642

(180) 04/08/2032

( 540 )

**BARE POWER**

(511) 30

(210) No. 47297

(220) 04/08/2022

(732) INTERNATIONAL FOODSTUFFS CO.  
LLC

AL-WAHDA STREET, INDUSTRIAL  
AREA NO. 1, P.O. BOX 4115, SHARJAH,  
UNITED ARAB EMIRATES

(111) No. 56643

(180) 04/08/2032

( 540 )

**SWEET SULTAN**

(511) 30

(210) No. 47298

(220) 04/08/2022

(732) INTERNATIONAL FOODSTUFFS CO.  
LLC

AL-WAHDA STREET, INDUSTRIAL  
AREA NO. 1, P.O. BOX 4115, SHARJAH,  
UNITED ARAB EMIRATES

(111) No. 56644

(180) 04/08/2032

( 540 )

**ACE**

(511) 30

(210) No. 47299

(220) 04/08/2022

(732) INTERNATIONAL FOODSTUFFS CO.  
LLC

AL-WAHDA STREET, INDUSTRIAL  
AREA NO. 1, P.O. BOX 4115, SHARJAH,  
UNITED ARAB EMIRATES

(111) No. 56645

(180) 04/08/2032

( 540 )

**BETTONI**

(511) 30

(210) No. 47300

(220) 04/08/2022

(732) INTERNATIONAL FOODSTUFFS CO.  
LLC

AL-WAHDA STREET, INDUSTRIAL  
AREA NO. 1, P.O. BOX 4115, SHARJAH,  
UNITED ARAB EMIRATES

(111) No. 56646

(180) 04/08/2032

( 540 )

TOFFIX

(511) 30

(210) No. 47301

(220) 04/08/2022

(732) INTERNATIONAL FOODSTUFFS CO.  
LLC

AL-WAHDA STREET, INDUSTRIAL  
AREA NO. 1, P.O. BOX 4115, SHARJAH,  
UNITED ARAB EMIRATES

(111) No. 56647

(180) 04/08/2032

( 540 )

WONDERFUEL

(511) 30

(210) No. 47302

(220) 04/08/2022

(732) INTERNATIONAL FOODSTUFFS CO.  
LLC

AL-WAHDA STREET, INDUSTRIAL  
AREA NO. 1, P.O. BOX 4115, SHARJAH,  
UNITED ARAB EMIRATES

(111) No. 56648

(180) 04/08/2032

( 540 )

**POWERFUEL**

(511) 30

(210) No. 47303

(220) 04/08/2022

(732) INTERNATIONAL FOODSTUFFS CO.  
LLC

AL-WAHDA STREET, INDUSTRIAL  
AREA NO. 1, P.O. BOX 4115, SHARJAH,  
UNITED ARAB EMIRATES

(111) No. 56649

(180) 04/08/2032

( 540 )

**BEAUTIFUEL**

(511) 30

(210) No. 47304

(220) 04/08/2022

(732) INTERNATIONAL FOODSTUFFS CO.  
LLC

AL-WAHDA STREET, INDUSTRIAL  
AREA NO. 1, P.O. BOX 4115, SHARJAH,  
UNITED ARAB EMIRATES

(111) No. 56650

(180) 04/08/2032



( 540 )

**PARADISE**

(511) 30

(210) No. 47305

(220) 04/08/2022

(732) INTERNATIONAL FOODSTUFFS CO.  
LLC

AL-WAHDA STREET, INDUSTRIAL  
AREA NO. 1, P.O. BOX 4115, SHARJAH,  
UNITED ARAB EMIRATES

(111) No. 56651

(180) 04/08/2032

( 540 )

**NUT TREE**

(511) 30

(210) No. 47306

(220) 04/08/2022

(732) INTERNATIONAL FOODSTUFFS CO.  
LLC

AL-WAHDA STREET, INDUSTRIAL  
AREA NO. 1, P.O. BOX 4115, SHARJAH,  
UNITED ARAB EMIRATES

(111) No. 56652

(180) 04/08/2032

( 540 )

LOTTO

(511) 30

(210) No. 47307

(220) 04/08/2022

(732) INTERNATIONAL FOODSTUFFS CO.  
LLC

AL-WAHDA STREET, INDUSTRIAL  
AREA NO. 1, P.O. BOX 4115, SHARJAH,  
UNITED ARAB EMIRATES

(111) No. 56653

(180) 04/08/2032

( 540 )

FIELD DAY

(511) 30

(210) No. 47308

(220) 04/08/2022

(732) INTERNATIONAL FOODSTUFFS CO.  
LLC

AL-WAHDA STREET, INDUSTRIAL  
AREA NO. 1, P.O, BOX 4115, SHARJAH,  
UNITED ARAB EMIRATES

(111) No. 56654

(180) 04/08/2032

( 540 )

**ALPHABITES**

(511) 30

(210) No. 47309

(220) 04/08/2022

(732) INTERNATIONAL FOODSTUFFS CO.  
LLC

AL-WAHDA STREET, INDUSTRIAL  
AREA NO. 1, P.O. BOX 4115, SHARJAH,  
UNITED ARAB EMIRATES

(111) No. 56655

(180) 04/08/2032

( 540 )

**SWICH CREAM UP**

(511) 30

(210) No. 47310

(220) 04/08/2022

(732) INTERNATIONAL FOODSTUFFS CO.  
LLC

AL-WAHDA STREET, INDUSTRIAL  
AREA NO. 1, P.O. BOX 4115, SHARJAH,  
UNITED ARAB EMIRATES

(111) No. 56656

(180) 04/08/2032

( 540 )



(511) 30

(210) No. 47311

(220) 04/08/2022

(732) INTERNATIONAL FOODSTUFFS CO.  
LLC

AL-WAHDA STREET, INDUSTRIAL  
AREA NO. 1, P.O. BOX 4115, SHARJAH,  
UNITED ARAB EMIRATES

(111) No. 56657

(180) 04/08/2032

( 540 )



(511) 30

(210) No. 47312

(220) 04/08/2022

(732) INTERNATIONAL FOODSTUFFS CO.  
LLC

AL-WAHDA STREET, INDUSTRIAL  
AREA NO. 1, P.O. BOX 4115, SHARJAH,  
UNITED ARAB EMIRATES

(111) No. 56658

(180) 04/08/2032

( 540 )



(511) 30

(210) No. 47313

(220) 04/08/2022

(732) INTERNATIONAL FOODSTUFFS CO.  
LLC

AL-WAHDA STREET, INDUSTRIAL  
AREA NO. 1, P.O. BOX 4115, SHARJAH,  
UNITED ARAB EMIRATES

(111) No. 56659

(180) 04/08/2032

( 540 )



(511) 30

(210) No. 47314

(220) 04/08/2022

(732) INTERNATIONAL FOODSTUFFS CO.  
LLC

AL-WAHDA STREET, INDUSTRIAL  
AREA NO. 1, P.O. BOX 4115, SHARJAH,  
UNITED ARAB EMIRATES

(111) No. 56660

(180) 04/08/2032

( 540 )



(511) 12

(210) No. 47243

(220) 01/08/2022

(732) ບໍລິສັດ ໂຮດາ ການຄ້າ ຈຳກັດຜູ້ດຽວ

ບ້ານ ໂພນໄຊ, ເມືອງໂພນໂຮງ, ແຂວງວຽງຈັນ,

ສປປ ລາວ

(111) No. 56661

(180) 01/08/2032

( 540 )



(511) 12

(210) No. 47244

(220) 01/08/2022

(732) ບໍລິສັດ ໂຮດາ ການຄ້າ ຈຳກັດຜູ້ດຽວ

ບ້ານ ໂພນໄຊ, ເມືອງໂພນໂຮງ, ແຂວງວຽງຈັນ,

ສປປ ລາວ

(111) No. 56662

(180) 01/08/2032

( 540 )

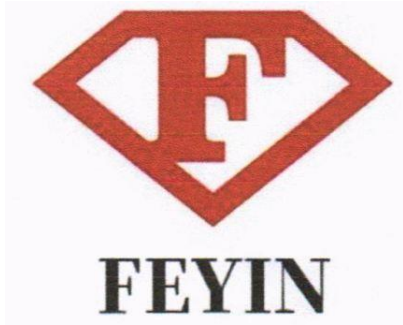

(511) 12

(210) No. 47245

(220) 01/08/2022

(732) ບໍລິສັດ ໂຮດາ ການຄ້າ ຈຳກັດຜູ້ດຽວ

ບ້ານ ໂພນໄຊ, ເມືອງໂພນໂຮງ, ແຂວງວຽງຈັນ,

ສປປ ລາວ

(111) No. 56663

(180) 01/08/2032

( 540 )



(511) 39

(210) No. 47259

(220) 02/08/2022

(732) ບໍລິສັດ ໄຊພະຈັນ ໂລຊິດສະຕິກ ຈຳກັດຜູ້ດຽວ

ບ້ານ ສີສະຫວາດ ເມືອງ ຈັນທະບູລີ,

ນະຄອນຫຼວງວຽງຈັນ, ສປປ ລາວ

(111) No. 56664

(180) 02/08/2032

( 540 )



(511) 05

(210) No. 47295

(220) 03/08/2022

(732) ບໍລິສັດ ລຸຊິວ ຝາມາຊີທິໂກ (ລາວ) ຈຳກັດ

ບ້ານ ທົ່ງມັງ, ເມືອງ ໄຊທານີ, ນະຄອນຫຼວງວຽງຈັນ,

ສປປ ລາວ

(111) No. 56665

(180) 03/08/2032

( 540 )



(511) 05

(210) No. 47318

(220) 04/08/2022

(732) ທ່ານ ລິດອານິນ ປະທຸມມະວັນ

ບ້ານ ໄຮ່ຄຳ, ເມືອງ ໄຊເສດຖາ, ນະຄອນຫຼວງວຽງຈັນ,

ສປປ ລາວ

(111) No. 56666

(180) 04/08/2032



( 540 )

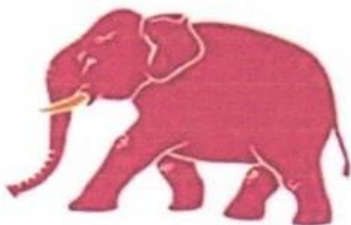

RED ELEPHANT

(511) 30

(210) No. 47331

(220) 09/08/2022

(732) ທ້າວ ຫງວຽນ ວັນຫວຽດ

ບ້ານ ແສງສະຫວ່າງ, ເມືອງ ໄຊເສດຖາ,

ນະຄອນຫຼວງວຽງຈັນ, ສປປ ລາວ

(111) No. 56667

(180) 09/08/2032

( 540 )



(511) 05

(210) No. 47342

(220) 12/08/2022

(732) ບໍລິສັດ ເທບທິດາ ການຄ້າ ຈຳກັດຜູ້ດຽວ

ຖະໜົນ ມິດຕະພາບລາວ-ໄທ, ບ້ານ ທົ່ງກາງ, ເມືອງ

ສີສັດຕະນາກ, ນະຄອນຫຼວງວຽງຈັນ, ສປປ ລາວ

(111) No. 56668

(180) 12/08/2032

( 540 )



(511) 35

(210) No. 47345

(220) 15/08/2022

(732) ບໍລິສັດ ແອວທິ ການຄ້າ ຂາອອກ-ຂາເຂົ້າ ຈຳກັດຜູ້ດຽວ  
ບ້ານ ທ່າຫຼວງ, ນະຄອນປາກເຊ, ສປປ ລາວ

(111) No. 56669

(180) 15/08/2032

( 540 )



(511) 30

(210) No. 47351

(220) 17/08/2022

(732) ໂຮງງານປຸງແຕ່ງຊາ ແສງຄຳ ລາວລີ  
ບ້ານ ວັດແກ້ວ, ເມືອງຜົ້ງສາລີ, ແຂວງ ຜົ້ງສາລີ,  
ສປປ ລາວ

(111) No. 56670

(180) 17/08/2032

( 540 )



The logo consists of the letters 'NR' in a large, bold, dark brown font, with the word 'NAREE' in a smaller, dark brown font directly below it.

(511) 22 and 35

(210) No. 47352

(220) 17/08/2022

(732) ຮ້ານ ນາຣີ ກະເປົາລາວປະຍຸກ

ບ້ານ ໜອງບອນ ເມືອງ ໄຊເສດຖາ,

ນະຄອນຫຼວງວຽງຈັນ, ສປປ ລາວ

(111) No. 56671

(180) 17/08/2032

( 540 )



A stylized logo featuring two characters, 'ບ' and 'ສ', in a decorative, calligraphic font.

(511) 22 and 35

(210) No. 47353

(220) 17/08/2022

(732) ຮ້ານ ນາຣີ ກະເປົາລາວປະຍຸກ

ບ້ານ.ໜອງບອນ ເມືອງ. ໄຊເສດຖາ,

ນະຄອນຫຼວງວຽງຈັນ, ສປປ ລາວ

(111) No. 56672

(180) 17/08/2032



A stylized logo featuring a butterfly-like shape with four wings, formed by a central vertical line and two curved lines extending outwards and upwards.

( 540 )



(511) 30

(210) No. 47361

(220) 19/08/2022

(732) ໂຮງງານປຸງແຕ່ງຊາ ສົມນົກ ລາວຖັງ

ບ້ານ ວັດແກ້ວ, ເມືອງຜົ້ງສາລີ, ແຂວງຜົ້ງສາລີ,

ສປປ ລາວ

(111) No. 56673

(180) 19/08/2032

( 540 )

SANÉ

(511) 25

(210) No. 47365

(220) 19/08/2022

(732) ທ້າວ ຮອນດ້າ ຫລວງພິທັກ

ບ້ານ ນາສ້ຽວ ເມືອງ ນາຊາຍທອງ,

ນະຄອນຫຼວງວຽງຈັນ, ສປປ ລາວ

(111) No. 56674

(180) 19/08/2032

( 540 )



(511) 35

(210) No. 47369

(220) 23/08/2022

(732) ບໍລິສັດ ເຄອິນ ການຄ້າສາກົນ ຈຳກັດຜູ້ດຽວ

ບ້ານ ເມືອງນ້ອຍ ເມືອງ ໄຊເສດຖາ,

ນະຄອນຫຼວງວຽງຈັນ, ສປປ ລາວ

(111) No. 56675

(180) 23/08/2032

( 540 )

ອາລາເສິນຕິງ 阿拉神丁

(511) 05

(210) No. 47373

(220) 24/08/2022

(732) ບໍລິສັດ ດີເອັຈອີເອ ຕິງກາ ຈຳກັດຜູ້ດຽວ

ບ້ານທາດຫຼວງເໜືອ, ເມືອງໄຊເສດຖາ,

ນະຄອນຫຼວງວຽງຈັນ, ສປປ ລາວ

(111) No. 56676

(180) 24/08/2032

( 540 )

**SPARKLE**

(511) 03 and 21  
(210) No. 47319  
(220) 04/08/2022  
(732) KURON CORPORATION LIMITED  
34 Keharomklao Road, Ratpattana,  
Saphansung, Thailand  
(111) No. 56682  
(180) 04/08/2032

( 540 )

**SPARKLE**

(511) 03 and 21  
(210) No. 47320  
(220) 04/08/2022  
(732) KURON CORPORATION LIMITED  
34 Keharomklao Road, Ratpattana"  
Saphansung, Bangkok 10240, Thailand  
(111) No. 56683  
(180) 04/08/2032

( 540 )

A stylized logo consisting of Thai characters in a bold, black, sans-serif font. The characters are arranged in a slightly curved, upward-sloping manner. The first character is 'ปี' (Pee), the second is 'ซ่า' (Saa), and the third is 'ซ่า' (Saa). The logo is positioned on the left side of the first entry box.

(511) 32

(210) No. 47321

(220) 04/08/2022

(732) PepsiCo, Inc.

700 Anderson Hill Road, Purchase, New  
York 10577, United States of America

(111) No. 56684

(180) 04/08/2032

( 540 )

The logo for the brand 'Champion', featuring the word 'Champion' in a black, cursive script font. The 'C' is stylized with a vertical bar through it. The logo is positioned on the left side of the second entry box.

(511) 18 and 25

(210) No. 47322

(220) 04/08/2022

(732) HBI Branded Apparel Enterprises, LLC

1000 East Hanes Mill Road, Winston-Salem,  
North Carolina 27105,  
United States of America

(111) No. 56685

(180) 04/08/2032

( 540 )



(511) 18 and 25

(210) No. 47323

(220) 04/08/2022

(732) HBI Branded Apparel Enterprises, LLC

1000 East Hanes Mill Road, Winston-Salem,  
North Carolina 27105,

United States of America

(111) No. 56686

(180) 04/08/2032

( 540 )

**REELS**

(511) 09, 38, 41 and 45

(210) No. 47324

(220) 05/08/2022

(732) Meta Platforms, Inc.

1601 Willow Road, Menlo Park, California  
94025, United States of America

(111) No. 56687

(180) 05/08/2032



( 540 )

**SAMYANG TANGLE**

(511) 30

(210) No. 47325

(220) 05/08/2022

(732) SAMYANG FOODS CO., LTD.

104, OPAESAN-RO 3-GIL, SEONGBUK-  
GU, SEOUL, REPUBLIC OF KOREA

(111) No. 56688

(180) 05/08/2032

( 540 )

**OPTYMAX**

(511) 01, 05 and 31

(210) No. 47326

(220) 05/08/2022

(732) Apical (Malaysia) Sdn. Bhd.

Level 6, Wisma Averis (Tower 2), Avenue 5,  
Bangsar South City,  
No. 8 Jalan Kerinchi, 59200 Kuala Lumpur,  
Malaysia

(111) No. 56689

(180) 05/08/2032

( 540 )



(511) 10

(210) No. 47333

(220) 09/08/2022

(732) DAIO PAPER CORPORATION  
2-60, MISHIMA-KAMIYA-CHO,  
SHIKOKUCHUO-SHI, EHIME-KEN,  
JAPAN

(111) No. 56690

(180) 09/08/2032

( 540 )



(511) 05

(210) No. 47334

(220) 09/08/2022

(732) DAIO PAPER CORPORATION  
2-60, MISHIMA-KAMIYA-CHO,  
SHIKOKUCHUO-SHI, EHIME-KEN,  
JAPAN

(111) No. 56691

(180) 09/08/2032

( 540 )

**PUANA**

(511) 16

(210) No. 47335

(220) 09/08/2022

(732) DAIO PAPER CORPORATION  
2-60, MISHIMA-KAMIYA-CHO,  
SHIKOKUCHUO-SHI, EHIME-KEN,  
JAPAN

(111) No. 56692

(180) 09/08/2032

( 540 )

**Rich Vision**

(511) 09

(210) No. 47336

(220) 09/08/2022

(732) Shenzhen Shengse Technology Co., Ltd.  
Room 601, No. 3, Jinshunyuan Factory  
(Phase II), Furong South Road,  
Tantou Community, Songgang Street, Baoan  
District, Shenzhen, China

(111) No. 56693

(180) 09/08/2032

( 540 )

**iQOO**

(511) 12

(210) No. 47337

(220) 09/08/2022

(732) VIVO MOBILE COMMUNICATION CO.,  
LTD.

No. 1, vivo Road, Chang'an, Dongguan,  
Guangdong, China

(111) No. 56694

(180) 09/08/2032

( 540 )

**MONSTER ENERGY**

(511) 32

(210) No. 47338

(220) 10/08/2022

(732) Monster Energy Company  
1 Monster Way, Corona, California 92879,  
United States of America

(111) No. 56695

(180) 10/08/2032

( 540 )

MONSTER

(511) 32

(210) No. 47339

(220) 10/08/2022

(732) Monster Energy Company

1 Monster Way, Corona, California 92879,  
United States of America

(111) No. 56696

(180) 10/08/2032

( 540 )



(511) 30 and 32

(210) No. 47340

(220) 10/08/2022

(732) Monster Energy Company

1 Monster Way, Corona, California 92879,  
United States of America

(111) No. 56697

(180) 10/08/2032

( 540 )

小花腰

(511) 30

(210) No. 47343

(220) 12/08/2022

(732) YUNNAN YUXI HUAZHUANG FROZEN  
FOOD CO., LTD.

TUANSHAN, TAIBEI ROAD, HONGTA  
DISTRICT, YUXI CITY, YUNNAN  
PROVINCE, CHINA

(111) No. 56698

(180) 12/08/2032

( 540 )

MY MILLENNIUM PRESTIGE

(511) 35 and 43

(210) No. 47344

(220) 15/08/2022

(732) Millennium & Copthorne International  
Limited

9 Raffles Place, #12-01 Republic Plaza,  
Singapore

(111) No. 56699

(180) 15/08/2032

( 540 )



(511) 09

(210) No. 47346

(220) 16/08/2022

(732) SHENZHEN TCL NEW TECHNOLOGY  
CO., LTD.

9/F, Building D4, International E City, 1001  
Zhongshan Park Road, Xili Street, Nanshan  
District, Shenzhen, 518000 Guangdong  
, China

(111) No. 56700

(180) 16/08/2032

( 540 )



(511) 10

(210) No. 47347

(220) 16/08/2022

(732) DAIO PAPER CORPORATION  
2-60, MISHIMA-KAMIYA-CHO,  
SHIKOKUCHUO-SHI, EHIME-KEN,  
JAPAN

(111) No. 56701

(180) 16/08/2032

( 540 )



(511) 09 and 42

(210) No. 47348

(220) 16/08/2022

(732) SU ZHONGQUN

NO. 33, XINZHUANG VILLAGE, LINGXI  
TOWN, CANGNAN COUNTY, ZHEJIANG  
PROVINCE, CHINA

(111) No. 56702

(180) 16/08/2032

( 540 )

Imtoken

(511) 09 and 42

(210) No. 47349

(220) 16/08/2022

(732) SU ZHONGQUN

NO. 33, XINZHUANG VILLAGE, LINGXI  
TOWN, CANGNAN COUNTY,  
ZHEJIANG PROVINCE, CHINA

(111) No. 56703

(180) 16/08/2032



( 540 )

toocki

(511) 09

(210) No. 47350

(220) 16/08/2022

(732) SHENZHEN TOOCKI NETWORK  
TECHNOLOGY CO., LTD.

5th Floor, Room 522, Building C2, Zhonghao  
Industrial Area, Xiangjiaotang Community,  
Bantian Street, Longgang District, Shenzhen,  
Guangdong, China

(111) No. 56704

(180) 16/08/2032

( 540 )



(511) 30

(210) No. 47354

(220) 17/08/2022

(732) THIEN CHEONG SDN. BHD.

11, 11A, 15,16,17 & 23 JALAN  
PERUSAHAAN RINGAN 1, KAWASAN  
INDUSTRI RINGAN MAK MANDIN,  
13400 BUTTERWORTH, PENANG,  
MALAYSIA

(111) No. 56705

(180) 17/08/2032

( 540 )



(511) 29

(210) No. 47355

(220) 17/08/2022

(732) THIEN CHEONG SDN. BHD.

11, 11A, 15,16,17 & 23 JALAN  
PERUSAHAAN RINGAN 1, KAWASAN  
INDUSTRI RINGAN MAK MANDIN,  
13400 BUTTERWORTH, PENANG,  
MALAYSIA

(111) No. 56706

(180) 17/08/2032

( 540 )



(511) 28

(210) No. 47356

(220) 17/08/2022

(732) WEIHAI SHENG CARLIN OUTDOOR  
CO.,LTD.

No. 66-5 Xinghai Road, Yangting town,  
Huancui district, Weihai city, Shandong  
Province, China

(111) No. 56707

(180) 17/08/2032

( 540 )

**DARK WONDER**

(511) 30

(210) No. 47357

(220) 18/08/2022

(732) Elite Gold Ltd.

Portcullis TrustNet Chambers, P.O. Box  
3444, Road Town, Tortola, British Virgin  
, Islands

(111) No. 56708

(180) 18/08/2032

( 540 )

**FED**

(511) 28

(210) No. 47358

(220) 18/08/2022

(732) Zhejiang Feier Intelligent Technology Co.,  
Ltd.

6-602, No.501, No.2 Street, Baiyang Street,  
Qiantang New District, Hangzhou City,  
Zhejiang Province CHINA 310000, China

(111) No. 56709

(180) 18/08/2032

( 540 )

SOKANY

(511) 08

(210) No. 47359

(220) 18/08/2022

(732) Yiwu Mingge Electric Appliance Co., Ltd.  
Room 15A07, International Chamber of  
Commerce Building, Building 2, Zhongfu  
Plaza, No. 799 Chengbei Road, Yiwu City,  
Zhejiang Province, China

(111) No. 56710

(180) 18/08/2032

( 540 )



(511) 05 and 10

(210) No. 47360

(220) 18/08/2022

(732) SANOFI

54, rue La Boetie, 75008 PARIS, France

(111) No. 56711

(180) 18/08/2032

( 540 )



(511) 29

(210) No. 47362

(220) 19/08/2022

(732) Rod Dee Ded (Thailand) Company Limited

118/25 Sai Mai Road, Sai Mai, Sai Mai

District, Bangkok 10220, Thailand

(111) No. 56712

(180) 19/08/2032

( 540 )



(511) 30

(210) No. 47363

(220) 19/08/2022

(732) Rod Dee Ded (Thailand) Company Limited

118/25 Sai Mai Road, Sai Mai, Sai Mai

District, Bangkok 10220, Thailand

(111) No. 56713

(180) 19/08/2032

( 540 )



(511) 43

(210) No. 47364

(220) 19/08/2022

(732) Rod Dee Ded (thailand) Company Limited  
118/25 Sai Mai Road, Sai Mai, Sai Mai  
District, Bangkok 10220, Thailand

(111) No. 56714

(180) 19/08/2032

( 540 )



(511) 16

(210) No. 47366

(220) 22/08/2022

(732) DAIO PAPER CORPORATION  
2-60, MISHIMA-KAMTYA-CHO,  
SHIKOKUCHUO-SHI, EHIME-KEN,  
JAPAN

(111) No. 56715

(180) 22/08/2032

( 540 )



(511) 35 and 39

(210) No. 47367

(220) 22/08/2022

(732) Kerry Logistics Network Limited

16/F Kerry Cargo Centre, 55 Wing Kei Road,  
Kwai Chung, New Territories, Hong Kong

(111) No. 56716

(180) 22/08/2032

( 540 )



(511) 35 and 39

(210) No. 47368

(220) 22/08/2022

(732) Kerry Logistics Network Limited

16/F Kerry Cargo Centre, 55 Wing Kei Road,  
Kwai Chung, New Territories, Hong Kong

(111) No. 56717

(180) 22/08/2032

( 540 )

**MΦNSTER**  
ENERGY

(511) 32

(210) No. 47370

(220) 24/08/2022

(732) Monster Energy Company

1 Monster Way, Corona, California 92879,  
United States of America

(111) No. 56718

(180) 24/08/2032

( 540 )

**แอนมัม**

(511) 05

(210) No. 47371

(220) 24/08/2022

(732) FONTERRA BRANDS (SINGAPORE) PTE  
LIMITED

182 Cecil Street, #15-01 Frasers Tower,  
Singapore 069547

(111) No. 56719

(180) 24/08/2032



( 540 )

**แอนด์**

(511) 29

(210) No. 47372

(220) 24/08/2022

(732) FONTERRA BRANDS (SINGAPORE) PTE  
LIMITED

182 Cecil Street, #15-01 Frasers Tower,  
06954, Singapore

(111) No. 56720

(180) 24/08/2032

( 540 )

**vvild**

(511) 34 and 35

(210) No. 47374

(220) 24/08/2022

(732) Shenzhen VVILD Technology Co., Ltd  
605 Building A Yuanzhengchuangyedasha,  
No. 19 Langshan Road,  
Songpingshanshequ, Xili Street, Nanshan  
District, Shenzhen, Guangdong, China

(111) No. 56721

(180) 24/08/2032

( 540 )

**VIMIZI**

(511) 34 and 35

(210) No. 47375

(220) 24/08/2022

(732) Shenzhen VVILD Technology Co., Ltd  
605 Building A Yuanzhengchuangyedasha,  
No. 19 Langshan Road,  
Songpingshanshequ, Xili Street, Nanshan  
District, Shenzhen, Guangdong  
, China

(111) No. 56722

(180) 24/08/2032

( 540 )

**SNP**

(511) 36 and 39

(210) No. 47376

(220) 25/08/2022

(732) Saigon Newport One Member Limited  
Liability Corporation  
722 Dien Bien Phu Street, Ward 22, Bitlh  
Thanh District. Ho Chi Minh City, Vietnam

(111) No. 56723

(180) 25/08/2032

( 540 )

**SNP Logistics**

(511) 36 and 39  
(210) No. 47377  
(220) 25/08/2022  
(732) Saigon Newport One Member Limited  
Liability Corporation  
722 Dien Bien Phu Street, Ward 22, Binh  
Thanh District, Ho Chi Minh City, Vietnam  
(111) No. 56724  
(180) 25/08/2032

( 540 )

**Tan Cang**

(511) 36 and 39  
(210) No. 47379  
(220) 25/08/2022  
(732) Saigon Newport One Member Limited  
Liability Corporation  
722 Dien Bien Phu Street, Ward 22, Binh  
Thanh District, Ho Chi Minh City, Vietnam  
(111) No. 56725  
(180) 25/08/2032

( 540 )



(511) 36 and 39

(210) No. 47380

(220) 25/08/2022

(732) Saigon Newport One Member Limited

Liability Corporation

722 Dien Bien Phu Street, Ward 22, Binh

Thanh District, Ho Chi Minh City, Vietnam

(111) No. 56726

(180) 25/08/2032

( 540 )



(511) 33

(210) No. 47381

(220) 25/08/2022

(732) BANGKOK BEER & BEVERAGES CO.,  
LTD.

809 Soi Pattanakarn 30, Suanluang Sub-

district, Suanluang District, Bangkok 10250,

Thailand

(111) No. 56727

(180) 25/08/2032

( 540 )



(511) 38 and 41

(210) No. 47384

(220) 29/08/2022

(732) RCN TELEVISION S.A.

AV. DE LAS AMERICAS NO. 65. 82

BOGOTA D.C, COLOMBIA

(111) No. 56728

(180) 29/08/2032

( 540 )



(511) 38 and 41

(210) No. 47385

(220) 29/08/2022

(732) RCN TELEVISION S.A.

AV. DE LAS AMERICAS NO.65- 82

BOGOTA D.C., COLOMBIA

(111) No. 56729

(180) 29/08/2032

( 540 )



(511) 20, 30, 35 and 43

(210) No. 47386

(220) 29/08/2022

(732) MEKONG YONGZHEN IMPORT-EXPORT  
SOLE CO., LTD

T2 Rd, Wattaynoythong Village,  
Sikhottabong District, Vientiane Cap, Lao  
People's Democratic Republic

(111) No. 56730

(180) 29/08/2032

( 540 )



(511) 04

(210) No. 47388

(220) 30/08/2022

(732) SUNDARAM-CLAYTON LIMITED

"Chaitanya", No.12, Khader Nawaz Khan  
Road, Nungambakkam, Chennai - 600006,  
Tamil Nadu, India

(111) No. 56731

(180) 30/08/2032

( 540 )

**STOM**

(511) 29

(210) No. 47389

(220) 30/08/2022

(732) SAFCOL HOLDINGS (HONG KONG)  
LIMITED

Room 2206, 22nd Floor, Billion Plaza, 8  
Cheung Yue Street, Cheung Sha Wan,  
Kowloon, Hong Kong

(111) No. 56732

(180) 30/08/2032

( 540 )

**STOM**

(511) 31

(210) No. 47390

(220) 30/08/2022

(732) SAFCOL HOLDINGS (HONG KONG)  
LIMITED

Room 2206, 22nd Floor Billion Plaza, 8  
Cheung Yue Street, Cheung Sha Wan,  
Kowloon, Hong Kong

(111) No. 56733

(180) 30/08/2032

( 540 )



(511) 12

(210) No. 47391

(220) 31/08/2022

(732) Jiangsu Jinpeng Group Co., Ltd

East of Tunshidagou Road, West of Tunqing  
Road, Xuzhou Industrial Park, Xuzhou City,  
Jiangsu Province, China

(111) No. 56734

(180) 31/08/2032

( 540 )



(511)

(210) No. 44660

(220) 19/06/2020

(732) ທ່ານ ໄພສະຫວ່າງ ຈໍາສານ

ໜ່ວຍ 02, ບ້ານ ວັດຈັນ, ເມືອງຈັນທະບູລີ,  
ນະຄອນຫຼວງວຽງຈັນ, ສປປ ລາວ

(111) No. 56736

(180) 19/06/2030



( 540 )



(511)

(210) No. 44665

(220) 19/06/2020

(732) ທ່ານ ໂພສະຫວ່າງ ຈຳສານ

ໜ່ວຍ 02, ບ້ານ ວັດຈັນ, ເມືອງຈັນທະບູລີ,

ນະຄອນຫຼວງວຽງຈັນ, ສປປ ລາວ

(111) No. 56739

(180) 19/06/2030

## ພາກທີ III

### (Part III)

## ເຄື່ອງໝາຍການຄ້າ

### Trademarks

## 3. ການຕໍ່ອາຍ

### (Renewal)

#### ຄຳອະທິບາຍກ່ຽວກັບລະຫັດຫຍໍ້

#### (Introduction of Codes)

- (540) ເຄື່ອງໝາຍການຄ້າ (Trademark)
- (511) ໝວດ (Nice Classification)
- (210) ເລກທີ ຄຳຮ້ອງ (Number of the application)
- (220) ວັນທີ ຄຳຮ້ອງ (Date of filing of the application)
- (732) ຊື່ ແລະ ທີ່ຢ ບໍ ຂອງຜູ້ຍື່ນຄຳຮ້ອງ (Name and Address of applicant)
- (111) ເລກທີການຈັດທະບຽນເຄື່ອງໝາຍການຄ້າ (Number of the registration)
- (180) ການຕໍ່ ອາຍ ການຈັດທະບຽນ (Expiration date of the renewal)

**ພາກທີ III**  
**(Part III)**

**ເຄື່ອງໝາຍການຄ້າ**  
**Trademarks**

**4. ການປ່ຽນແປງ**  
**(Changes)**

**ພາກທີ III**

**(Part III)**

**ເຄື່ອງໝາຍການຄ້າ**

**Trademarks**

**5. ການດັດແກ້**

**(Amendments)**

## ພາກທີ IV

### (Part IV)

## ເຄື່ອງໝາຍການຄ້າຜ່ານລະບົບມາດຣິດ

### Trademarks via Madrid Protocol

#### 1. ຄໍາຮ້ອງ

#### (Applications)

##### ຄໍາອະທິບາຍກ່ຽວກັບລະຫັດຫຍໍ້

##### (Introduction of Codes)

- (540) ເຄື່ອງໝາຍການຄ້າ (Trademark)
- (511) ໝວດ (Nice Classification)
- (210) ເລກທີ ຄໍາຮ້ອງ (Number of the application)
- (220) ວັນທີ ຄໍາຮ້ອງ (Date of filing of the application)
- (732) ຊື່ ແລະ ທີ່ຢ ບໍ ຂອງຜູ້ຍື່ນຄໍາຮ້ອງ (Name and Address of applicant)

( 540 )



(511) 12

(210) No. M/1244334

(220) 06/01/2023

(732) JIANGSU GENERAL SCIENCE  
TECHNOLOGY CO., LTD.

Gangxia, Donggang Town, Xishan District,  
Wuxi City 214199 Jiangsu Province, China

( 540 )



(511) 01 and 04

(210) No. M/1260786

(220) 17/02/2023

(732) COMPAÑÍA ESPAÑOLA DE  
PETRÓLEOS, S.A.

Paseo de la Castellana 259 - A E-28046  
MADRID, Spain

( 540 )

**MERIEUX**

(511) 01, 05, 09, 10, 35, 36, 37, 41, 42 and 44

(210) No. M/1303400

(220) 08/12/2022

(732) INSTITUT MERIEUX

17 rue Bourgelat F-69002 LYON, France

( 540 )

**HEI Schools**

(511) 09, 16, 28, 35, 41, 42 and 45

(210) No. M/1413352

(220) 14/02/2023

(732) Helsinki International Schools Group Oy

Kaikukatu 4 B FI-00530 Helsinki, Finland

( 540 )

**RELIFE**

(511) 08

(210) No. M/1464016

(220) 06/02/2023

(732) GUANGZHOU SUNSHINE

ELECTRONICS TECHNOLOGY CO., LTD.

ROOM 303, NO. 61 YANJIANG WEST

RD., LIWAN DIST., GUANGZHOU

GUANGDONG, CHINA

( 540 )

**FBN**

(511) 05

(210) No. M/1467544

(220) 13/02/2023

(732) TAIHO PHARMACEUTICAL CO., LTD.

1-27 Kandnishiki-cho, Chiyoda-ku Tokyo 101-

8444, Japan



( 540 )

h  
e  
i

(511) 09, 16, 28, 35, 41, 42 and 45

(210) No. M/1474139

(220) 14/02/2023

(732) Helsinki International Schools Group Oy  
Kaikukatu 4 B FI-00530 Helsinki, Finland

( 540 )



(511) 34

(210) No. M/1477021

(220) 19/01/2023

(732) CHINA TOBACCO SICHUAN  
INDUSTRIAL CO., LTD.  
NO. 2 LONGQUAN SECTION,  
CHENGLONG AVENUE, NATIONAL  
CHENGDU ECONOMY AND  
TECHNOLOGY DEVELOPMENT AREA,  
LONGQUANYI DISTRICT, CHENGDU  
CITY SICHUAN PROVINCE, CHINA

( 540 )

**RELIFE**

(511) 09

(210) No. M/1533572

(220) 06/02/2023

(732) GuangZhou Sunshine Electronics Technology  
Co., Ltd.

Room303, No.61 Yanjiang West Rd., Liwan  
Dist., GuangZhou GuangDong Province,  
China

( 540 )

**Elant**

(511) 11

(210) No. M/1589321

(220) 12/12/2022

(732) Huizhou Elant Technology Co., Ltd

Plant of No. 24 Community, Jiangbei,  
Huicheng District, Huizhou City Guangdong  
Province, China

( 540 )



(511) 03 and 05

(210) No. M/1591951

(220) 16/01/2023

(732) Jiangxi Kangmei Medical &Health-cares  
Co.,Ltd  
No.6 Gexuan Road, Zhangshu City Jiangxi  
Province, China

( 540 )

**caIMR**

(511) 10

(210) No. M/1636835

(220) 05/01/2023

(732) SUZHOU RAINMED MEDICAL  
TECHNOLOGY CO., LTD.  
Room 502, Building 5, Northwest District,  
Nano City, No.99 Jinjihu Avenue, Suzhou  
Industrial Park Jiangsu Province, China

( 540 )

**caFFR**

(511) 10

(210) No. M/1636836

(220) 05/01/2023

(732) SUZHOU RAINMED MEDICAL  
TECHNOLOGY CO., LTD.

Room 502, Building 5, Northwest District,  
Nano City, No.99 Jinjihu Avenue, Suzhou  
Industrial Park Jiangsu Province, China

( 540 )

**FlashPressure**

(511) 10

(210) No. M/1636839

(220) 05/01/2023

(732) SUZHOU RAINMED MEDICAL  
TECHNOLOGY CO., LTD.

Room 502, Building 5, Northwest District,  
Nano City, No.99 Jinjihu Avenue, Suzhou  
Industrial Park Jiangsu Province, China

( 540 )

**LINVOL**

(511) 07 and 37

(210) No. M/1636895

(220) 13/02/2023

(732) Midea Group Co., Ltd.

B26-28F, Midea Headquarter Building, No. 6  
Midea Avenue, Beijiao, Shunde, Foshan  
Guangdong, China

( 540 )

**RainMed**

(511) 09 and 35

(210) No. M/1637616

(220) 05/01/2023

(732) SUZHOU RAINMED MEDICAL

TECHNOLOGY CO., LTD.

Room 502, Building 5, Northwest District,  
Nano City, No.99 Jinjihu Avenue, Suzhou  
Industrial Park Jiangsu Province, China

( 540 )

**FlashAngio**

(511) 09 and 10

(210) No. M/1641539

(220) 05/01/2023

(732) SUZHOU RAINMED MEDICAL  
TECHNOLOGY CO., LTD.

Room 502, Building 5, Northwest District,  
Nano City, No.99 Jinjihu Avenue, Suzhou  
Industrial Park Jiangsu Province, China

( 540 )

**CELIMO**

(511) 12

(210) No. M/1651941

(220) 10/01/2023

(732) Jiangsu General Science Technology Co.,  
Ltd.

Gangxia, Donggang Town, Xishan District,  
Wuxi City Jiangsu Province, China

( 540 )



(511) 12

(210) No. M/1657295

(220) 06/02/2023

(732) Shanghai Paidian Technology Co., Ltd.  
3rd Floor, Building 1, No. 9138 Beiqing  
Road, Qingpu District 201700 Shanghai,  
China

( 540 )

Topcolor

(511) 03

(210) No. M/1673000

(220) 30/01/2023

(732) YIWU CHENFEI COSMETICS Co., LTD  
No. 98 Xiangyi Road, Yiting Town, Yiwu  
City Zhejiang Province, China

( 540 )

**TALVEY**

(511) 05

(210) No. M/1683262

(220) 01/03/2023

(732) Janssen Pharmaceutica NV

Turnhoutseweg 30 B-2340 Beerse, Belgium

( 540 )

**RECCI**

(511) 09

(210) No. M/1708749

(220) 09/01/2023

(732) Shenzhen Maxco Technology Co., Ltd.

9F906, Bairuida Building, Bantian Street,

Longgang District 518000 Shenzhen, China



( 540 )

**STARLINK**

(511) 09, 38, 39 and 42

(210) No. M/1713437

(220) 17/02/2023

(732) Space Exploration Technologies Corp.

1 Rocket Road Hawthorne CA 90250,

United States of America

( 540 )

**Memorist**

(511) 09, 35, 38, 39 and 42

(210) No. M/1718291

(220) 12/12/2022

(732) ARKHENUM

7 rue Joseph Bonnet F-33100 BORDEAUX,

France

( 540 )

**SELVERT**  
T H E R M A L

(511) 03

(210) No. M/1718638

(220) 04/11/2022

(732) INVESTIGACIÓN Y DESARROLLO DE  
COSMÉTICOS, S.A.

Calle Costa Brava, 30 E-08030 Barcelona,  
Spain

( 540 )



(511) 09, 12, 18, 25 and 35

(210) No. M/1718744

(220) 19/12/2022

(732) O'NEAL Europe GmbH & Co. KG

Erich-Blum-Str. 33 71665 Vaihingen an der  
Enz, Germany

( 540 )

**LuK RepSet**

(511) 07 and 12

(210) No. M/1718862

(220) 28/11/2022

(732) Schaeffler Technologies AG & Co. KG  
Industriestr. 1-3 91074 Herzogenaurach,  
Germany

( 540 )

**CiaoBosi**

(511) 07

(210) No. M/1719003

(220) 24/12/2022

(732) Hong Liwan  
No. 88, Dongsheng Road, Li'ao Street, Ouhai  
District, Wenzhou City Zhejiang Province,  
China

( 540 )

The logo consists of the letters 'MKGO' in a bold, black, sans-serif font. The letters are closely spaced and have a uniform thickness.

(511) 14

(210) No. M/1719100

(220) 11/01/2023

(732) PENG, Gengwen

Room 1804, No.636, Yuncheng East Road,  
Baiyun District, Guangzhou City Guangdong  
Province, China

( 540 )

The logo features the letters 'KAIYI' in a stylized, black, sans-serif font. The letters are bold and have a modern, geometric appearance with some internal cutouts.

(511) 37

(210) No. M/1719103

(220) 08/12/2022

(732) Yibin Kaiyi Automobile Co., Ltd.

Room 328, Enterprise Service Center, No.17  
Lingang Avenue, Yibin Lingang Economic  
and Technological Development Zone, Yibin  
City 644000 Sichuan Province, China

( 540 )

**SVMY**

(511) 03 and 21

(210) No. M/1719104

(220) 10/02/2023

(732) Zhang Yan

Elevator 1, Plant No. 20, Baoshang Road,  
Niansanli, Yiwu City Zhejiang Province,  
China

( 540 )

**OPPO Life**

(511) 21

(210) No. M/1719125

(220) 07/12/2022

(732) GUANGDONG OPPO MOBILE

TELECOMMUNICATIONS CORP., LTD.

No. 18 Haibin Road, Wusha, Chang'an,

Dongguan Guangdong, China

( 540 )



(511) 21

(210) No. M/1719150

(220) 01/02/2023

(732) Sichuan Hongshengzhien Food Company Ltd

No. 1, 2nd Floor, Building 8, No. 1288,  
Xingle North Road, Xindu Street, Xindu  
District, Chengdu City 610500 Sichuan  
Province, China

( 540 )

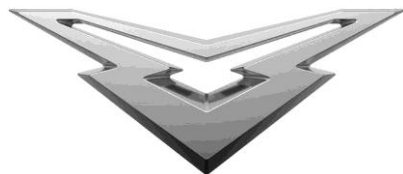

(511) 12 and 37

(210) No. M/1719300

(220) 08/12/2022

(732) Yibin Kaiyi Automobile Co., Ltd.

Room 328, Enterprise Service Center, No. 17  
Lingang Avenue, Yibin Lingang Economic  
and Technological Development Zone, Yibin  
City 644000 Sichuan Province, China

( 540 )



(511) 09, 25, 30, 35, 38, 41 and 42

(210) No. M/1719341

(220) 09/12/2022

(732) Huanxiu Technology (Shanghai) Co., Ltd.  
16th Floor, No. 129 Yan'an West Road,  
Jing'an District 200040 Shanghai City, China

( 540 )

***TTFAR***

(511) 07, 09 and 12

(210) No. M/1719375

(220) 03/01/2023

(732) YADEA TECHNOLOGY GROUP CO.,  
LTD.  
DONGSHENG ROAD, DACHENG  
INDUSTRIAL ZONE, ANZHEN TOWN,  
XISHAN DISTRICT, WUXI CITY 214000  
JIANGSU PROVINCE, CHINA

( 540 )

**uMC**

(511) 10

(210) No. M/1719393

(220) 20/12/2022

(732) Shanghai United Imaging Healthcare Co., Ltd.

No. 2258 Chengbei Rd., Jiading District

Shanghai, China

( 540 )

**Li Mind**

(511) 09 and 12

(210) No. M/1719398

(220) 10/02/2023

(732) Beijing Chj Information Technology Co., Ltd.

Room 101, Building 1, No. 4 Hengxing Road,

Gaoliying, Shunyi District 101300 Beijing

(Technological Innovation Industry

Functional Zone), China



( 540 )

**VIGCOM**

(511) 09

(210) No. M/1719431

(220) 24/11/2022

(732) VICTORY GLASSES COMPANY  
LIMITED

15/46, Doan Nhu Hai Street, Ward 12,  
District 4 Ho Chi Minh City, Vietnam

( 540 )

**TLG**

(511) 12

(210) No. M/1719460

(220) 28/12/2022

(732) TAILG Science and Technology (Jiangsu)  
Inc., Ltd.

No. 3 Dongsheng Road, Anzhen Street,  
Xishan District, Wuxi City 214000 Jiangsu  
Province, China

( 540 )

**Tribit**

(511) 09

(210) No. M/1719463

(220) 07/12/2022

(732) Shenzhen Yunwangtianxia E-commerce  
Co.,Ltd.

Room 201, Building A, No.1 Qianwan Road,  
Qianhai Shenzhen-Hong Kong Cooperation  
Zone, Shenzhen City 518000 Guangdong  
Province, China

( 540 )

**FALLINMISS 非谜**

(511) 18 and 25

(210) No. M/1719493

(220) 04/01/2023

(732) Wenzhou Fallinmiss Fashion Enterprise  
Development Co., Ltd.

Room 2304, Renhui Building, No.995 Ouhai  
Avenue, Ouhai District, Wenzhou City  
Zhejiang Province, China

( 540 )

**Nowwa**

(511) 30, 35 and 43

(210) No. M/1719506

(220) 21/12/2022

(732) Shanghai Lixing Technology Co., Ltd.

Room 2015, 2nd floor, No. 201 Branch

Tianshan Road, Changning District Shanghai,

China

( 540 )

**BEWITH**

(511) 03 and 21

(210) No. M/1719513

(220) 13/01/2023

(732) Zhejiang Chuyi Cosmetics Co., Ltd.

4F, Building 3, No. 170, Haopai Road, Suxi

Town, Yiwu City 322009 Zhejiang Province,

China

( 540 )



(511) 01, 07 and 09

(210) No. M/1719536

(220) 02/12/2022

(732) JIANGSU HANBON SCIENCE &  
TECHNOLOGY CO., LTD.

No. 1-9 Jixian Road and No.10 Xinzhu Road,  
Economic Development Zone, Huai'An  
223010 Jiangsu, China

( 540 )

**QUANXING 铨兴**

(511) 09

(210) No. M/1719540

(220) 06/01/2023

(732) Shenzhen Quanxing Tech Co., Ltd.

3507A Saige Square, No. 1002 Huaqiang  
North Road, Fuqiang Community, Huaqiang  
North Street, Futian District, Shenzhen  
Guangdong, China

( 540 )

**YUANJIA**

(511) 12

(210) No. M/1719546

(220) 13/12/2022

(732) TAIZHOU YUANJIA INDUSTRY CO.,  
LTD.

Houyang Village, Xicheng, Huangyan  
District, Taizhou city Zhejiang Province,  
China

( 540 )



(511) 35, 41 and 45

(210) No. M/1719579

(220) 12/12/2022

(732) Organisation Internationale de la  
Francophonie

19-21 Avenue Bosquet F-75007 Paris, France

## ພາກທີ IV

### (Part IV)

## ເຄື່ອງໝາຍການຄ້າຜ່ານລະບົບມາດຣິດ

### Trademarks via Madrid Protocol

## 2. ຜົນການຈົດທະບຽນ

### (Registration)

#### ຄຳອະທິບາຍກ່ຽວກັບລະຫັດຫຍໍ້

#### (Introduction of Codes)

- (540) ເຄື່ອງໝາຍການຄ້າ (Trademark)
- (511) ໝວດ (Nice Classification)
- (210) ເລກທີ ຄຳຮ້ອງ (Number of the application)
- (220) ວັນທີ ຍື່ນຄຳຮ້ອງ (Date of filing of the application)
- (732) ຊື່ ແລະ ທີ່ຢ ບໍ ຂອງຜູ້ຍື່ນຄຳຮ້ອງ (Name and Address of applicant)
- (111) ເລກທີການຈົດທະບຽນເຄື່ອງໝາຍການຄ້າ (Number of the registration)
- (180) ວັນໝົດອາຍ ຂອງການຈົດທະບຽນ (Expiration date of the registration)

( 540 )

**EKSELENCE**

(511) 29, 30 and 32

(210) No. M/0996874

(220) 02/06/2022

(732) RĪGAS PIENA KOMBINĀTS, A/S

Bauskas Iela 180 LV-1004 Rīga, Latvia

(111) No. M/0996874

(180) 07/10/2028

( 540 )

**morfose**

(511) 03

(210) No. M/1473213

(220) 19/01/2022

(732) MORFOSE KİŞİSEL BAKIM VE

KOZMETİK ÜRÜNLERİ SANAYİ

TİCARET ANONİM ŞİRKETİ

Barbaros Hayrettin Paşa Mahallesi, 1992

Sokak, No: 16 Kat:12 Daire:249 Esenyurt

İstanbul, Turkey

(111) No. M/1473213

(180) 10/04/2029

( 540 )



(511) 25 and 35

(210) No. M/1490402

(220) 01/03/2022

(732) RENWAR FASHION MANUFACTURING  
& MARKETING (1993) LTD.

13 Arie Shenkar st. Rishon Le'zion, Israel

(111) No. M/1490402

(180) 19/06/2029

( 540 )



(511) 01 and 17

(210) No. M/1667536

(220) 08/08/2022

(732) VERSALIS S.P.A.

PIAZZA BOLDRINI 1, SAN DONATO

MILANESE I-20097 MILANO, ITALY

(111) No. M/1667536

(180) 11/03/2032



( 540 )

**AGON**

(511) 01 and 17

(210) No. M/1667609

(220) 08/08/2022

(732) VERSALIS S.P.A.

PIAZZA BOLDRINI 1, SAN DONATO

MILANESE I-20097 MILANO, ITALY

(111) No. M/1667609

(180) 11/03/2032

( 540 )

 **顺丰同城**

(511) 35, 39 and 42

(210) No. M/1670389

(220) 17/05/2022

(732) SF (IP) LIMITED

12/F, San Toi Building, 137-139 Connaught

Road Central Hong Kong, China

(111) No. M/1670389

(180) 17/05/2032

( 540 )

**BYHERZYN**

(511) 05

(210) No. M/1670942

(220) 26/07/2022

(732) Zymeworks Inc.

Suite 800 - 114 East 4th Avenue Vancouver

BC V5T 1G4, Canada

(111) No. M/1670942

(180) 09/06/2032

( 540 )

**ZIHERA**

(511) 05

(210) No. M/1671312

(220) 26/07/2022

(732) Zymeworks Inc.

Suite 800 - 114 East 4th Avenue Vancouver

BC V5T 1G4, Canada

(111) No. M/1671312

(180) 09/06/2032

( 540 )

**SPARKOO**

(511) 09 and 42

(210) No. M/1675414

(220) 13/06/2022

(732) Huawei Cloud Computing Technologies Co.,  
Ltd.

Huawei Cloud Data Center, Jiaoxinggong  
Road, Qianzhong Avenue, Gui'an New  
District 550025 Guizhou, China

(111) No. M/1675414

(180) 13/06/2032

( 540 )

**ZEUS ARTIFACTS**

(511) 09, 28 and 41

(210) No. M/1675521

(220) 07/04/2022

(732) Euro Games Technology Ltd.

4, "Maritsa" Str. "Vranya-Lozen-Triugulnika"  
BG-1151 Sofia, Bulgaria

(111) No. M/1675521

(180) 07/04/2032

( 540 )

**HONOR X04**

(511) 09

(210) No. M/1675605

(220) 24/03/2022

(732) Honor Device Co., Ltd.

Suite 3401, Unit A, Building 6, Shum Yip  
Sky Park, No. 8089, Hongli West Road,  
Xiangmihu Street, Futian District, Shenzhen  
518040 Guangdong, China

(111) No. M/1675605

(180) 24/03/2032

( 540 )



(511) 12

(210) No. M/1675653

(220) 30/05/2022

(732) CHINA NATIONAL HEAVY DUTY

TRUCK GROUP CO., LTD.

Sinotruk Tower, No. 777 Hua'ao Road,

Innovation Zone, Jinan Shandong, China

(111) No. M/1675653

(180) 30/05/2032

( 540 )



(511) 29, 30 and 32

(210) No. M/1675709

(220) 22/02/2022

(732) Kraft Foods Schweiz Holding GmbH

Chollerstrasse 4 CH-6300 Zug, Switzerland

(111) No. M/1675709

(180) 22/02/2032

( 540 )



(511) 12

(210) No. M/1675932

(220) 26/04/2022

(732) NSK OTOMOTİV SANAYİ VE TİCARET

ANONİM ŞİRKETİ

TAVŞANLI MAH. 412 SK. NSK 1 -4 1

KARACABEY BURSA, TURKEY

(111) No. M/1675932

(180) 26/04/2032

( 540 )

**SINO BAND**

(511) 09

(210) No. M/1675960

(220) 07/05/2022

(732) Shenzhen Sinoband Electric Co., Ltd

1305 Room, Solar Silicon Valley, Yunfeng

Road, Gaofeng District, Dalang Street Baoan,

Shenzhen, China

(111) No. M/1675960

(180) 07/05/2032

( 540 )

**BURNING  
DIAMONDS**

(511) 09, 28 and 41

(210) No. M/1676047

(220) 11/03/2022

(732) Euro Games Technology Ltd.

"Maritsa" Str. 4, "Vranya-Lozen-Triugulnika"

BG-1151 Sofia, Bulgaria

(111) No. M/1676047

(180) 11/03/2032

( 540 )



(511) 33

(210) No. M/1676084

(220) 04/07/2022

(732) Lark Distillery Pty Ltd

Level 1, 91-93 Macquarie Street HOBART

TAS 7000, Australia

(111) No. M/1676084

(180) 04/07/2032

( 540 )

**Magic Ultimate**

(511) 09

(210) No. M/1676193

(220) 28/04/2022

(732) Honor Device Co., Ltd.

Suite 3401, Unit A, Building 6, Shum Yip

Sky Park, No. 8089, Hongli West Road,

Xiangmihu Street, Futian District, Shenzhen

518040 Guangdong, China

(111) No. M/1676193

(180) 28/04/2032

( 540 )



(511) 07

(210) No. M/1676206

(220) 16/05/2022

(732) SUZHOU CAI MACHINE GROUP CO.,  
LTD.

No. 8 SHITIAN ROAD, YANGCHENGHU  
TOWN, XIANGCHENG DISTRICT,  
SUZHOU CITY 215138 JIANGSU, CHINA

(111) No. M/1676206

(180) 16/05/2032

( 540 )



(511) 02

(210) No. M/1676309

(220) 16/05/2022

(732) Fumin Kungang Jiahe Decoration Materials  
Co., Ltd

Daying hardware and building materials  
Industrial Park, Fumin County Industrial  
Park, Kunming City 650000 Yunnan  
Province, China

(111) No. M/1676309

(180) 16/05/2032



( 540 )

**Jackery**

(511) 07 and 11

(210) No. M/1676333

(220) 15/06/2022

(732) JACKERY INC.

48531 Warm Springs Blvd 408 Fremont CA

94539-7793, United States of America

(111) No. M/1676333

(180) 15/06/2032

( 540 )

**SUN EIGHT**

(511) 18

(210) No. M/1676335

(220) 18/05/2022

(732) HUNAN SUNSHINE LUGGAGE CO., LTD.

South of Qingsong Road and North of

Minwang Road, Sanxing Community

Ecological Industrial Park, Liangshitang

Street, Shaodong City, Shaoyang City Hunan

Province, China

(111) No. M/1676335

(180) 18/05/2032

( 540 )



(511) 07 and 21

(210) No. M/1676448

(220) 13/05/2022

(732) QINGDAO TEMU MACHINERY

EQUIPMENT CO.,LTD.

4-2-402, NO. 29 DONGHAI MIDDLE

ROAD, SHINAN DISTRICT, QINGDAO

266000 SHANDONG, CHINA

(111) No. M/1676448

(180) 13/05/2032

( 540 )

**BARBARABANG**

(511) 09, 38, 41 and 42

(210) No. M/1676552

(220) 18/03/2022

(732) Stropus Ltd.

7-9 Riga Fereou, Lizantia Court, office 310,

Agioi Omologites CY-1087 Nicosia, Cyprus

(111) No. M/1676552

(180) 18/03/2032

( 540 )

**Schaeffler DuraWave**

(511) 07 and 09

(210) No. M/1676634

(220) 16/02/2022

(732) Schaeffler Technologies AG & Co. KG

Industriestr. 1-3 91074 Herzogenaurach,  
Germany

(111) No. M/1676634

(180) 16/02/2032

( 540 )

**SKYWORTH**

(511) 09 and 10

(210) No. M/1676655

(220) 02/03/2022

(732) SKYWORTH GROUP CO., LTD.

22-24/F, Skyworth Semiconductor Design  
Bldg, 18 High-Tech Sout 4th Rd, Nanshan  
Dist 518057 Shenzhen, China

(111) No. M/1676655

(180) 02/03/2032

( 540 )

VIMERLEA'S SPRING

(511) 25

(210) No. M/1676760

(220) 17/05/2022

(732) Weng Yibing

No. 10, Eleventh Lane, Yizai District,  
Dongming, Gurao Town, Chaoyang District,  
Shantou City 515000 Guangdong Province,  
China

(111) No. M/1676760

(180) 17/05/2032

( 540 )

NEWTIMES

(511) 26

(210) No. M/1676787

(220) 18/05/2022

(732) Lordhair (Qingdao) Co., Ltd

B-807, Lubang Plaza, No.177, Shandong  
Road, Shibe District, Qingdao City  
Shandong Province, China

(111) No. M/1676787

(180) 18/05/2032

( 540 )



(511) 09, 12, 14, 16, 17, 18, 25, 28, 35, 37, 41 and  
42

(210) No. M/1676855

(220) 10/12/2021

(732) PIRELLI & C. S.p.A.

Viale Piero e Alberto Pirelli 25 I-20126

MILANO, Italy

(111) No. M/1676855

(180) 10/12/2031

( 540 )

**DAREU**

(511) 28

(210) No. M/1676903

(220) 16/05/2022

(732) Dongguan Dareu Electronics Audio Co., Ltd

Room 301, building 3, Yuhua Rd 3, Juzhou,

Shijie Town, Dongguan City 523000

Guangdong, China

(111) No. M/1676903

(180) 16/05/2032

( 540 )

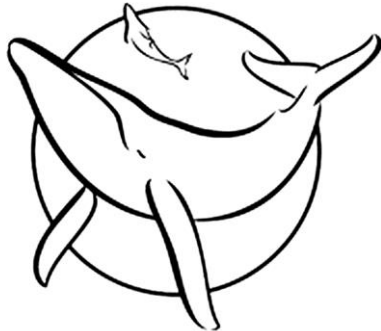

**SEA SHEPHERD**

(511) 16, 25, 35, 41 and 42

(210) No. M/1677168

(220) 08/03/2022

(732) Sea Shepherd Conservation Society

209 E. Alameda Ave. #205 Burbank CA

91502, United States of America

(111) No. M/1677168

(180) 08/03/2032

( 540 )

**NET ZERO**

(511) 22

(210) No. M/1677189

(220) 21/03/2022

(732) AmSafe Bridport Limited

The Court, West Street Bridport, Dorset DT6

3QU, United Kingdom

(111) No. M/1677189

(180) 21/03/2032

( 540 )



(511) 33

(210) No. M/1677373

(220) 04/07/2022

(732) Lark Distillery Pty Ltd

Level 1, 30 Argyle Street HOBART TAS

7000, Australia

(111) No. M/1677373

(180) 04/07/2032

( 540 )

(511) 09, 35, 41 and 42

(210) No. M/1677430

(220) 21/02/2022

(732) KUMON INSTITUTE OF EDUCATION

CO., LTD.

5-6-6 Nishinakajima, Yodogawa-ku, Osaka-

shi Osaka 532-8511, Japan

(111) No. M/1677430

(180) 21/02/2032

( 540 )

**Doosan Enerbility**

(511) 06, 07, 09, 11, 35, 36, 37, 39, 40 and 42

(210) No. M/1677567

(220) 10/02/2022

(732) DOOSAN CORPORATION

275, Jangchungdan-ro, Jung-gu Seoul,

Republic of Korea

(111) No. M/1677567

(180) 10/02/2032

( 540 )

**YASWARA**

(511) 03

(210) No. M/1677599

(220) 24/02/2022

(732) JETHARAM NEMARAM GEHLOT

101, Shree White Heights Apartment,

saraswati Nagar, Hirawadi Road, Panchavati,

Nashik Maharashtra 422003, India

(111) No. M/1677599

(180) 24/02/2032



( 540 )



(511) 01, 04, 07, 08, 11, 36, 38, 39 and 40

(210) No. M/1677668

(220) 29/11/2021

(732) PIRELLI & C. S.p.A.

Viale Piero e Alberto Pirelli 25 I-20126

Milano, Italy

(111) No. M/1677668

(180) 29/11/2031

( 540 )



(511) 09, 28 and 41

(210) No. M/1677678

(220) 12/01/2022

(732) Euro Games Technology Ltd.

4, "Maritsa" Str., "Vranya-Lozen-

Triugulnika" BG-1151 Sofia, Bulgaria

(111) No. M/1677678

(180) 12/01/2032

( 540 )

**BYRYZN**

(511) 03, 05 and 10

(210) No. M/1677746

(220) 27/04/2022

(732) HUGEL INC.

61-20, Sinbuk-ro, Sinbuk-eup, Chuncheon-si

Gangwon-do, Republic of Korea

(111) No. M/1677746

(180) 27/04/2032

( 540 )

**MACOS VENTURA**

(511) 09

(210) No. M/1677892

(220) 11/07/2022

(732) Apple Inc.

One Apple Park Way Cupertino CA 95014,

United States of America

(111) No. M/1677892

(180) 11/07/2032

( 540 )

*Tobler*

(511) 29, 30 and 32

(210) No. M/1678029

(220) 17/02/2022

(732) Kraft Foods Schweiz Holding GmbH

Chollerstrasse 4 CH-6300 Zug, Switzerland

(111) No. M/1678029

(180) 17/02/2032

( 540 )

**HL Mando**

(511) 35, 36, 37, 39, 40, 41 and 42

(210) No. M/1678033

(220) 04/07/2022

(732) Halla Holdings Corporation

46, Giheungdanji-ro, Giheung-gu, Yongin-si

Gyeonggi-do, Republic of Korea

(111) No. M/1678033

(180) 04/07/2032

( 540 )



(511) 09

(210) No. M/1678066

(220) 12/05/2022

(732) Guangzhou Sanjing Electric Co.,Ltd.

SAJ Innovation Park, No.9, Lizhishan Road,

Science City, Guangzhou High-tech Zone,

Guangzhou Guangdong, China

(111) No. M/1678066

(180) 12/05/2032

( 540 )



(511) 33

(210) No. M/1678069

(220) 08/06/2022

(732) AMB SARL

1 Rue Jean Jaurès F-74000 Annecy, France

(111) No. M/1678069

(180) 08/06/2032

( 540 )



(511) 09, 11, 12, 25, 35, 38, 41 and 42

(210) No. M/1678138

(220) 18/02/2022

(732) International Business Machines Corporation

New Orchard Road Armonk NY 10504,

United States of America

(111) No. M/1678138

(180) 18/02/2032

( 540 )



(511) 07

(210) No. M/1678215

(220) 03/03/2022

(732) G.LOONG Elevator Co., Ltd

697-698 Shengli Rd., Nanxun District,

Huzhou City 313000 Zhejiang Province,

China

(111) No. M/1678215

(180) 03/03/2032

( 540 )

**AWOX** 

(511) 07, 08, 09, 10, 11, 21, 34 and 35

(210) No. M/1678248

(220) 30/12/2021

(732) TECTONE TEKNOLOJI SANAYI VE

TICARET ANONİM ŞİRKETİ

Organize Sanayi Bölgesi Atatürk, Caddesi 8.

Sokak No: 8, Karaagac Koyu Kapaklı

Tekirdağ, Turkey

(111) No. M/1678248

(180) 30/12/2031

( 540 )

**Microclean filter**

(511) 11

(210) No. M/1678408

(220) 17/12/2021

(732) ARÇELİK ANONİM ŞİRKETİ

SÜTLÜCE MAH. KARAAĞAÇ CAD. NO:6

Beyoğlu İstanbul, Turkey

(111) No. M/1678408

(180) 17/12/2031

( 540 )

**LOONG**

(511) 07

(210) No. M/1678460

(220) 03/03/2022

(732) G.LOONG Elevator Co.,Ltd

697-698 Shengli Rd. Nanxun District,

Huzhou city 313000 Zhejiang Province,

China

(111) No. M/1678460

(180) 03/03/2032

( 540 )

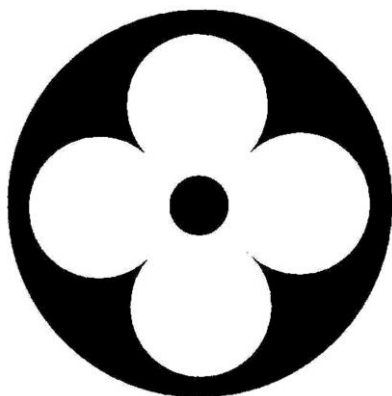

(511) 03, 09, 14, 16, 18, 24, 25, 30, 34 and 43

(210) No. M/1678502

(220) 31/12/2021

(732) LOUIS VUITTON MALLETIER

2 rue du Pont Neuf F-75001 Paris, France

(111) No. M/1678502

(180) 31/12/2031

( 540 )

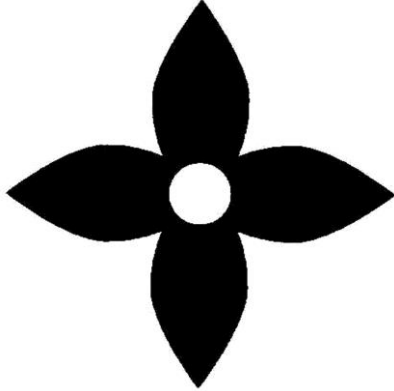

(511) 03, 09, 14, 16, 18, 24, 25, 30, 34 and 43

(210) No. M/1678503

(220) 31/12/2021

(732) LOUIS VUITTON MALLETIER

2 rue du Pont Neuf F-75001 Paris, France

(111) No. M/1678503

(180) 31/12/2031

( 540 )

The word "AION" is written in a bold, black, sans-serif font. The letters are thick and closely spaced, with a modern, geometric feel.

(511) 07, 09, 12, 35 and 37

(210) No. M/1678584

(220) 11/05/2022

(732) GAC AION NEW ENERGY AUTOMOBILE  
CO.,LTD.

No.36, Longying Road, Panyu District,

Guangzhou 511400 Guangdong, China

(111) No. M/1678584

(180) 11/05/2032



( 540 )

**FAENZA**

(511) 06, 20 and 21

(210) No. M/1678628

(220) 11/01/2022

(732) FOSHAN CITY FAENZA SANITARY

WARE CO., LTD

Sanzhou Park, East Zone, Cangjiang Ind.

Zone, Gaoming District, Foshan City 528511

Guangdong Province, China

(111) No. M/1678628

(180) 11/01/2032

( 540 )

**HONOR RAM Turbo**

(511) 09

(210) No. M/1678639

(220) 20/04/2022

(732) Honor Device Co., Ltd.

Suite 3401, Unit A, Building 6, Shum Yip

Sky Park, No. 8089, Hongli West Road,

Xiangmihu Street, Futian District, Shenzhen

518040 Guangdong, China

(111) No. M/1678639

(180) 20/04/2032

( 540 )

**Flaming Heart**

(511) 09, 28 and 41

(210) No. M/1678774

(220) 28/04/2022

(732) Euro Games Technology Ltd.

4, "Maritsa" Str., "Vranya-Lozen-Triugulnika"

BG-1151 Sofia, Bulgaria

(111) No. M/1678774

(180) 28/04/2032

( 540 )

**衡昌烧坊**  
HENGCHANGSHAOFANG

(511) 33 and 35

(210) No. M/1678801

(220) 18/04/2022

(732) Guizhou Province Renhuai City Maotai Town

Hengchang Shaofang Brewery Co., Ltd.

Tutanba Group, Chunshu Village, Maotai

Town, Renhuai City, Zunyi City Guizhou

Province, China

(111) No. M/1678801

(180) 18/04/2032

( 540 )

**WENOVUS**

(511) 07

(210) No. M/1678826

(220) 01/06/2022

(732) WEIMA AGRICULTURAL MACHINERY  
CO., LTD.

Luohuang Industrial Park Area B, Jiangjin  
Chongqing, China

(111) No. M/1678826

(180) 01/06/2032

( 540 )



(511) 33

(210) No. M/1678870

(220) 19/07/2022

(732) Chivas Holdings (IP) Limited

Kilmalid Stirling Road, Dumbarton

Renfrewshire G82 2SS, United Kingdom

(111) No. M/1678870

(180) 19/07/2032

( 540 )

**DAREX**

(511) 01, 02 and 17

(210) No. M/1678899

(220) 12/05/2022

(732) Henkel IP & Holding GmbH

Henkelstrasse 67 40589 Düsseldorf, Germany

(111) No. M/1678899

(180) 12/05/2032

( 540 )

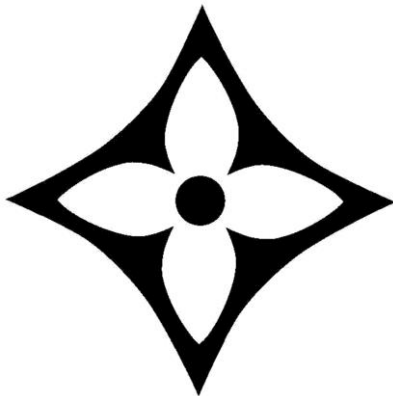

(511) 03, 09, 14, 16, 18, 24, 25, 30, 34 and 43

(210) No. M/1678959

(220) 31/12/2021

(732) LOUIS VUITTON MALLETIER

2 rue du Pont Neuf F-75001 Paris, France

(111) No. M/1678959

(180) 31/12/2031

( 540 )



(511) 12 and 35

(210) No. M/1679022

(220) 18/02/2022

(732) TOYOTA JIDOSHA KABUSHIKI KAISHA

(also trading as TOYOTA MOTOR  
CORPORATION)

1, Toyota-cho, Toyota-shi Aichi-ken 471-  
8571, Japan

(111) No. M/1679022

(180) 18/02/2032

( 540 )



(511) 09, 28 and 41

(210) No. M/1679026

(220) 27/04/2022

(732) Euro Games Technology Ltd.

4, "Maritsa" Str., "Vranya-Lozen-  
Triugulnika" BG-1151 Sofia, Bulgaria

(111) No. M/1679026

(180) 27/04/2032

( 540 )

HONOR Magic Live

(511) 09

(210) No. M/1679131

(220) 20/04/2022

(732) Honor Device Co., Ltd.

Suite 3401, Unit A, Building 6, Shum Yip  
Sky Park, No. 8089, Hongli West Road,  
Xiangmihu Street, Futian District, Shenzhen  
518040 Guangdong, China

(111) No. M/1679131

(180) 20/04/2032

( 540 )



(511) 09 and 14

(210) No. M/1679134

(220) 07/06/2022

(732) Swatch AG (Swatch SA) (Swatch Ltd.)

Nicolas G. Hayek Strasse 1 CH-2502  
Biel/Bienne, Switzerland

(111) No. M/1679134

(180) 07/06/2032

( 540 )

## Flaming Wish

(511) 09, 28 and 41

(210) No. M/1679153

(220) 28/04/2022

(732) Euro Games Technology Ltd.

4, "Maritsa" Str., "Vranya-Lozen-Triugulnika"

BG-1151 Sofia, Bulgaria

(111) No. M/1679153

(180) 28/04/2032

( 540 )

## The Eye of Muse

(511) 09

(210) No. M/1679154

(220) 21/03/2022

(732) Honor Device Co., Ltd.

Suite 3401, Unit A, Building 6, Shum Yip

Sky Park, No. 8089, Hongli West Road,

Xiangmihu Street, Futian District, Shenzhen

518040 Guangdong, China

(111) No. M/1679154

(180) 21/03/2032

( 540 )



(511) 12

(210) No. M/1679236

(220) 29/03/2022

(732) Wenzhou Dongqi Auto Parts Manufacture  
Co., LTD.

No.485 Yanshan Road, Bei'ao Street,

Dongtou District, Wenzhou Zhejiang, China

(111) No. M/1679236

(180) 29/03/2032

( 540 )

**BONDERITE**

(511) 01, 02, 03, 04 and 17

(210) No. M/1679463

(220) 13/05/2022

(732) Henkel AG & Co. KGaA

Henkelstrasse 67 40589 Düsseldorf, Germany

(111) No. M/1679463

(180) 13/05/2032



( 540 )

## **Flaming Crystal**

(511) 09, 28 and 41

(210) No. M/1679657

(220) 28/04/2022

(732) Euro Games Technology Ltd.

4, "Maritsa" Str., "Vranya-Lozen-Triugulnika"

BG-1151 Sofia, Bulgaria

(111) No. M/1679657

(180) 28/04/2032

( 540 )

## **FLAVYREN**

(511) 03, 05, 30 and 34

(210) No. M/1679675

(220) 11/04/2022

(732) AFYREN

9-11 Rue Gutenberg F-63000 CLERMONT

FERRAND, France

(111) No. M/1679675

(180) 11/04/2032

( 540 )

**JADEVER**

(511) 06, 07, 08, 09, 11 and 35

(210) No. M/1679696

(220) 20/01/2022

(732) CHONGQING AMITY MACHINERY CO.,  
LTD.

28-5# No. 200 Zhongshan 2 Road, Yuzhong  
District 400014 Chongqing, China

(111) No. M/1679696

(180) 20/01/2032

( 540 )

**KYB**

(511) 09 and 12

(210) No. M/1679707

(220) 17/03/2022

(732) KYB Corporation

4-1, Hamamatsu-cho 2-chome, Minato-ku  
Tokyo 105-5128, Japan

(111) No. M/1679707

(180) 17/03/2032

( 540 )

**GROOVE**

(511) 10

(210) No. M/1679877

(220) 08/07/2022

(732) OKAMOTO INDUSTRIES, INC.

27-12, Hongo 3-chome, Bunkyo-ku Tokyo

113-0033, Japan

(111) No. M/1679877

(180) 08/07/2032

( 540 )



(511)

(210) No. M/1073421

(220) 10/02/2020

(732) Czech Blades s.r.o.

Brněnská 559 CZ-569 43 Jevíčko,

Czech Republic

(111) No. M/1073421

(180) 04/02/2031

( 540 )

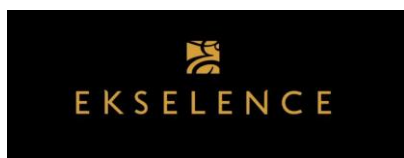

(511) 30

(210) No. M/1262177

(220) 02/06/2022

(732) RĪGAS PIENA KOMBINĀTS, A/S

Bauskas Iela 180 LV-1004 Rīga, Latvia

(111) No. M/1262177

(180) 24/04/2025

( 540 )

**OATLY**

(511) 05, 09, 14, 18, 21, 25, 29, 30, 32, 35, 39, 41  
and 43

(210) No. M/1393445

(220) 24/05/2022

(732) Oatly AB

Box 588 SE-201 25 Malmö, Sweden

(111) No. M/1393445

(180) 13/07/2027

( 540 )

**GYPLINE**

(511)

(210) No. M/1441177

(220) 31/03/2020

(732) SAINT-GOBAIN PLACO

Tour Saint-Gobain, 12 Place de l'Iris F-92400

COURBEVOIE, France

(111) No. M/1441177

(180) 14/11/2028

( 540 )

**BOLT**

(511)

(210) No. M/1554607

(220) 19/05/2020

(732) Bolt Support KE Limited

2nd Floor, Azure Towers, Lantana Road,

Westlands Nairobi, Kenya

(111) No. M/1554607

(180) 19/05/2030

( 540 )



(511)

(210) No. M/1607855

(220) 22/06/2021

(732) Grimaldi Industri AB

Hovslagargatan 5B, 2nd fl. SE-111 48

Stockholm, Sweden

(111) No. M/1607855

(180) 22/06/2031

( 540 )



(511)

(210) No. M/1608846

(220) 22/06/2021

(732) Grimaldi Industri AB

Hovslagargatan 5B, 2nd fl. SE-111 48

Stockholm, Sweden

(111) No. M/1608846

(180) 22/06/2031

( 540 )

**OFFSET Nutrition**

(511) 05, 09, 25, 29, 32 and 35

(210) No. M/1676323

(220) 07/06/2022

(732) Famous Brands GmbH

Erfstraße 15-17 50672 Köln, Germany

(111) No. M/1676323

(180) 07/06/2032

( 540 )



(511) 03

(210) No. M/1676352

(220) 07/06/2022

(732) Fucheng, ZHAO

Room 302, Building 3, No.7 of Shuyuan

Street, Remin North Road, Luohu District,

Shenzhen City 510000 Guangdong Province,

China

(111) No. M/1676352

(180) 07/06/2032

( 540 )

極樂湯

(511) 43 and 44

(210) No. M/1676409

(220) 10/06/2022

(732) GOKURAKUYU HOLDINGS CO., LTD.

Kojimachi Tsuruya Hachiman BLDG 6F, 4,

Kojimachi 2-chome, Chiyoda-ku Tokyo 102-

0083, Japan

(111) No. M/1676409

(180) 10/06/2032

( 540 )

ELESSY

(511) 03 and 21

(210) No. M/1676451

(220) 06/06/2022

(732) Guangzhou Yashen Trading Co., Ltd.

(Part: Shop 201) Room 201, Building 3, No.

2, Wanggang Road, Huadu District,

Guangzhou City Guangdong Province, China

(111) No. M/1676451

(180) 06/06/2032



( 540 )



(511) 29 and 30

(210) No. M/1676757

(220) 20/05/2022

(732) Henan Shuanghui Investment & Development  
Co., Ltd.

No. 1, Shuanghui Road, Luohe City 462000

Henan Province, China

(111) No. M/1676757

(180) 20/05/2032

( 540 )



(511) 09

(210) No. M/1676824

(220) 26/05/2022

(732) Dux Ducis Technology Co., Ltd.

Room 901, Block 18, Zhonghaixin

Innovation Industrial Park, Jihua, Longgang,

Shenzhen 518000 Guangdong, China

(111) No. M/1676824

(180) 26/05/2032

( 540 )

**维希儿**  
**WEIXIER**

(511) 18

(210) No. M/1676936

(220) 31/05/2022

(732) Baoding Qingmu Leather Manufacturing Co.,  
Ltd.

Alley No. 5, North of Renhe Middle Rd.,  
Baigou New Town, Baoding 071000 Hebei,  
China

(111) No. M/1676936

(180) 31/05/2032

( 540 )

**uBioEXPLORER**

(511) 09 and 10

(210) No. M/1677472

(220) 31/05/2022

(732) Shanghai United Imaging Healthcare Co.,  
Ltd.

No. 2258 Chengbei Rd., Jiading District  
Shanghai, China

(111) No. M/1677472

(180) 31/05/2032

( 540 )

**uExphas**

(511) 09

(210) No. M/1678079

(220) 09/06/2022

(732) WuHan United Imaging Life Science

Instrument Co.,Ltd

(Free Trade Zone Wuhan Area), Room G2-

103, Institute of New Energy Building, 999

Gaoxin Avenue, Donghu Hi-tech Development

Zone, Wuhan Hubei Province, China

(111) No. M/1678079

(180) 09/06/2032

( 540 )

**mibro**

(511) 09 and 14

(210) No. M/1678589

(220) 24/05/2022

(732) Zhenshi Information Technology (Shanghai)

Company Limited

Room 4015, Building 2, No. 588 Zixing

Road, Minhang District 201100 Shanghai

City, China

(111) No. M/1678589

(180) 24/05/2032

( 540 )



(511) 12

(210) No. M/1678856

(220) 27/06/2022

(732) SHANGHAI JIDU AUTOMOBILE CO.,  
LTD.

Building 2, No. 1688 Yecheng Road, Jiading  
District 200000 Shanghai, China

(111) No. M/1678856

(180) 27/06/2032

( 540 )



**luckin coffee**

(511) 11, 30, 35 and 43

(210) No. M/1679061

(220) 10/06/2022

(732) Luckin Coffee Group Co., Ltd.

28th Floor, Building T3, Haixi Jingu Plaza, 1  
- 3 Taibei Road, Siming District, Xiamen  
City 100020 Fujian Province, China

(111) No. M/1679061

(180) 10/06/2032

( 540 )



(511) 34

(210) No. M/1679265

(220) 08/06/2022

(732) FLUMGIO TECHNOLOGY INC.

14748 NELSON AVE UNIT C CITY OF  
INDUSTRY CA 91744,

UNITED STATES OF AMERICA

(111) No. M/1679265

(180) 08/06/2032

( 540 )

**Mornwell**

(511) 21

(210) No. M/1676907

(220) 14/06/2022

(732) Shenzhen Risun Technology Co., Ltd.

Room 101, Building A, Xinmusheng Low  
Carbon Industrial Park, No. 6 Xinmu Avenue,  
Xinmu Community, Pinghu Street, Longgang  
District, Shenzhen City Guangdong Province,  
China

(111) No. M/1676907

(180) 14/06/2032

( 540 )

KUKIRIN

(511) 12

(210) No. M/1679165

(220) 16/06/2022

(732) Shenzhen City Heng Zhi He Technology Co.  
Ltd

4F4006, Shenzhou computer building,  
Madame Curie Avenue, wankecheng  
community, Bantian street, Longgang  
District, Shenzhen City 518000 Guangdong  
Province, China

(111) No. M/1679165

(180) 16/06/2032

( 540 )



(511) 14

(210) No. M/1679198

(220) 16/06/2022

(732) SEIKO GROUP KABUSHIKI KAISHA

(trading as SEIKO GROUP  
CORPORATION)

5-11, Ginza 4-chome, Chuo-ku Tokyo 104-  
8110, Japan

(111) No. M/1679198

(180) 16/06/2032

( 540 )



The logo for Grand Seiko features a stylized 'GS' monogram above the words 'Grand Seiko' in a classic serif font.

(511) 14

(210) No. M/1679199

(220) 16/06/2022

(732) SEIKO GROUP KABUSHIKI KAISHA

(trading as SEIKO GROUP

CORPORATION)

5-11, Ginza 4-chome, Chuo-ku Tokyo 104-  
8110, Japan

(111) No. M/1679199

(180) 16/06/2032

( 540 )



The logo for BOOST Juice bars features the word 'BOOST' in large, colorful, outlined letters (B: red, O: green, O: yellow, S: red, T: orange) above the words 'Juice bars' in a green, lowercase, sans-serif font.

(511) 32 and 43

(210) No. M/1402621

(220) 28/06/2022

(732) Boost Juice Holdings Pty Ltd ACN 102 379

591

Level 8, M-City Business District 2107-2125

Dandenong Road CLAYTON VIC 3168,

Australia

(111) No. M/1402621

(180) 17/01/2028

( 540 )

The logo for C&S Paper Co., Ltd. features the letters 'C' and 'S' in a bold, sans-serif font, with an ampersand (&) positioned between them. The ampersand is stylized, with its loops extending upwards and downwards, creating a sense of movement and connection between the two letters.

(511) 16

(210) No. M/1540829

(220) 23/06/2022

(732) C&S PAPER CO., LTD.

Tanbeishenglong Village, Dongsheng Town,

528414 Zhongshan City, Guangdong

Province, China

(111) No. M/1540829

(180) 21/04/2030

( 540 )

The logo for Eastern Air Logistics Co., Ltd. consists of the letters 'EAL' in a bold, sans-serif font. The 'E' is the largest and most prominent, with a thick, blocky design. The 'A' and 'L' are slightly smaller and also have a thick, blocky appearance, matching the style of the 'E'.

(511) 39

(210) No. M/1678500

(220) 21/06/2022

(732) Eastern Air Logistics Co., Ltd.

No.66 Jichang Avenue, Pudong International

Airport Shanghai, China

(111) No. M/1678500

(180) 21/06/2032



( 540 )

**呀诺达**

(511) 39, 41, 43 and 44

(210) No. M/1678559

(220) 21/06/2022

(732) Hainan Yanoda Yuanrong Tourism Co.,Ltd.  
Sandao Town, Baoting City Hainan Province,  
China

(111) No. M/1678559

(180) 21/06/2032

( 540 )



(511) 14

(210) No. M/1679592

(220) 27/06/2022

(732) Monjour Watch Group SA (Monjour Watch  
Group AG) (Monjour Watch Group Ltd.)  
Zentralstrasse 46 CH-2502 Biel/Bienne,  
Switzerland

(111) No. M/1679592

(180) 27/06/2032

( 540 )

信遠齋

(511) 32

(210) No. M/1679627

(220) 28/06/2022

(732) BEIJING XINYUANZHAI BEVERAGE

CO., LTD.

Room 701, Block 2, Yuanjia Guoji

Apartment, No.40, Dongzhongjie,

Dongzhimenwai, Dongcheng District Beijing,

China

(111) No. M/1679627

(180) 28/06/2032

## ພາກທີ IV (Part IV)

### ເຄື່ອງໝາຍການຄ້າຜ່ານລະບົບມາດຣິດ Trademarks via Madrid Protocol

#### 3. ຜົນການຕໍ່ອາຍຸ (Renewal)

##### ຄຳອະທິບາຍກ່ຽວກັບລະຫັດຫຍໍ້ (Introduction of Codes)

- (540) ເຄື່ອງໝາຍການຄ້າ (Trademark)
- (511) ໝວດ (Nice Classification)
- (210) ເລກທີ ຄຳຮ້ອງ (Number of the application)
- (220) ວັນທີ ຍື່ນຄຳຮ້ອງ (Date of filing of the application)
- (732) ຊື່ ແລະ ທີ່ຢ ບໍ ຂອງຜູ້ຍື່ນຄຳຮ້ອງ (Name and Address of applicant)
- (111) ເລກທີການຈົດທະບຽນເຄື່ອງໝາຍການຄ້າ (Number of the registration)
- (180) ການຕໍ່ ອາຍ ຂອງການຈົດທະບຽນ (Expiration date of the renewal)

**ພາກທີ IV**

**(Part IV)**

**ເຄື່ອງໝາຍການຄ້າຜ່ານລະບົບມາດຣິດ**

**Trademarks via Madrid Protocol**

**4. ການປ່ຽນແປງ**

**(Changes)**

**ພາກທີ IV**

**(Part IV)**

**ເຄື່ອງໝາຍການຄ້າຜ່ານລະບົບມາດຣິດ**

**Trademarks via Madrid Protocol**

**5. ການດັດແກ້**

**(Amendments)**

**ພາກທີ V**  
**(Part V)**  
**ຖິ່ນກຳເນີດ**  
**Geographical Indications**

**1. ຄຳຮ້ອງ**  
**(Applications)**

**ພາກທີ V**  
**(Part V)**  
**ຖິ່ນກຳເນີດ**  
**Geographical Indications**

**2. ຜົນການຈົດທະບຽນ**  
**(Registration)**

**ພາກທີ V**

**(Part V)**

**ຖິ່ນກຳເນີດ**

**Geographical Indications**

**3. ການປ່ຽນແປງ**

**(Changes)**



**ພາກທີ V**  
**(Part V)**  
**ຖິ່ນກຳເນີດ**  
**Geographical Indications**

**4. ການດັດແກ້**  
**(Amendments)**

**ພາກທີ VI**

**(Part VI)**

**ພັນພືດໃໝ່**

**New Plant Varieties**

**1. ຄໍາຮ້ອງ**

**(Applications)**

**ພາກທີ VI**

**(Part VI)**

**ພັນພືດໃໝ່**

**New Plant Varieties**

**2. ຜົນການຈັດທະບຽນ**

**(Registration)**

**ພາກທີ VI**  
**(Part VI)**

**ພັນພືດໃໝ່**  
**New Plant Varieties**

**3. ການປ່ຽນແປງ**  
**(Changes)**

**ພາກທີ VI**

**(Part VI)**

**ພັນພືດໃໝ່**

**New Plant Varieties**

**4. ການດັດແກ້**

**(Amendments)**

**ພາກທີ VII**

**(Part VII)**

**ລິຂະສິດ ແລະ ສິດກ່ຽວຂ້ອງກັບລິຂະສິດ**

**Copyrights and Related Rights**

**1. ການແຈ້ງຂໍ້ມູນ**

**(Notifications)**

**ພາກທີ VII**

**(Part VII)**

**ລິຂະສິດ ແລະ ສິດກ່ຽວຂ້ອງກັບລິຂະສິດ**

**Copyrights and Related Rights**

**2. ການປ່ຽນແປງ**

**(Changes)**

**ພາກທີ VIII**

**(Part VIII)**

**ການແກ້ໄຂຂໍ້ຂັດແຍ່ງທາງດ້ານບໍລິຫານກ່ຽວກັບການຈົດ**

**ທະບຽນຊັບສິນອຸດສາຫະກຳ ແລະ ພັນພືດໃໝ່**

**Administrative Dispute Resolutions on the Registration of  
Industrial Property and New Plant Varieties**

**1. ຜົນການຄັດຄ້ານຄຳຮ້ອງ**

**(Result of Oppositions)**



## **ພາກທີ VIII**

### **(Part VIII)**

**ການແກ້ໄຂຂໍ້ຂັດແຍ່ງທາງດ້ານບໍລິຫານກ່ຽວກັບການຈົດ**

**ທະບຽນຊັບສິນອຸດສາຫະກຳ ແລະ ພັນພືດໃໝ່**

**Administrative Dispute Resolutions on the Registration of  
Industrial Property and New Plant Varieties**

### **2. ຜົນການແຈ້ງປະຕິເສດ**

**(Result of Refusals)**

**ພາກທີ VIII**

**(Part VIII)**

**ການແກ້ໄຂຂໍ້ຂັດແຍ່ງທາງດ້ານບໍລິຫານກ່ຽວກັບການຈົດ  
ທະບຽນຊັບສິນອຸດສາຫະກຳ ແລະ ພັນພືດໃໝ່**

**Administrative Dispute Resolutions on the Registration of  
Industrial Property and New Plant Varieties**

**3. ຜົນການຍົກເລີກ ຫຼື ລົບລ້າງ ຂອງການຈົດທະບຽນ  
(Result of Cancellation or Invalidation of Registration)**