



ສາທາລະນະລັດ ປະຊາທິປະໄຕ ປະຊາຊົນລາວ  
LAO PEOPLE'S DEMOCRATIC REPUBLIC

ກະຊວງ ອຸດສາຫະກຳ ແລະ ການຄ້າ  
ກົມຊັບສິນທາງປັນຍາ

MINISTRY OF INDUSTRY AND COMMERCE  
DEPARTMENT OF INTELLECTUAL PROPERTY

ຈົດໝາຍເຫດທາງລັດຖະການ  
ກ່ຽວກັບ ຊັບສິນທາງປັນຍາ  
ຢູ່ ສປປ ລາວ

OFFICIAL GAZETTE ON INTELLECTUAL PROPERTY  
IN LAO PDR

# ພາກທີ I

## (Part I)

### ສິດທິບັດ ແລະ ອະນຸສິດທິບັດ

### (Patent and Petty Patent)

## 1. ຄໍາຮ້ອງ

### (Applications)

#### ຄໍາອະທິບາຍກ່ຽວກັບລະຫັດຫຍໍ້

#### (Introduction of Codes)

- (21) ເລກທີ ຄໍາຮ້ອງ (Filing Number)
- (22) ວັນທີ ຍືນຄໍາຮ້ອງ (Filing Date)
- (30) ວັນທີ ບຸລິມະສິດ (Priority Date)
- (43) ວັນທີເຜີຍແຜ່ (Publication Date)
- (51) ໝວດ (International Patent Classification)
- (54) ຊື່ຂອງການປະດິດ (Title)
- (57) ບົດຄັດຫຍໍ້ (Abstract)
- (71) ຊື່ ແລະ ທີ່ຢູ່ ເຈົ້າຂອງສິດທິບັດ ແລະ ອະນຸສິດທິບັດ (Owner Name and Address)
- (72) ຊື່ຜູ້ປະດິດ (Inventor Name)
- (74) ຊື່ຕົວແທນ (Representative Name)
- (55) ຮູບພາບ (Pictures)

# ພາກທີ I

## (Part I)

### ສິດທິບັດ ແລະ ອະນຸສິດທິບັດ

### (Patent and Petty Patent)

## 2. ຜົນການອອກສິດທິບັດ ແລະ ອະນຸສິດທິບັດ

### (Grant of Patents and Petty Patents)

#### ຄໍາອະທິບາຍກ່ຽວກັບລະຫັດຫຍໍ້

#### (Introduction of Codes)

- (11) ເລກທີ (Grant Number)
- (21) ເລກທີ ຄໍາຮ້ອງ (Filing Number)
- (22) ວັນທີຍືນຄໍາຮ້ອງ (Filing Date)
- (30) ວັນທີ ບຸລິມະສິດ (Priority Date)
- (43) ວັນທີເຜີຍແຜ່ (Publication Date)
- (51) ໝວດ (International Patent Classification)
- (54) ຫົວຂໍ້ການປະດິດ (Title)
- (57) ບົດຄັດຫຍໍ້ (Abstract)
- (71) ຊື່ ແລະ ທີ່ຢູ່ ເຈົ້າຂອງສິດທິບັດ ແລະ ອະນຸສິດທິບັດ (Owner Name and Address)
- (72) ຊື່ຜູ້ປະດິດ (Inventor Name)
- (74) ຊື່ຕົວແທນ (Representative Name)
- (55) ຮູບພາບ (Pictures)

## ພາກທີ I

### (Part I)

## ສິດທິຂັດ ແລະ ອະນຸສິດທິຂັດ

### (Patent and Petty Patent)

### 3. ການປ່ຽນແປງ

#### (Changes)

**ພາກທີ I**

**(Part I)**

**ສິດທິບັດ ແລະ ອະນຸສິດທິບັດ**

**(Patent and Petty Patent)**

**4. ການດັດແກ້**

**(Amendments)**

**ພາກທີ II**  
**(Part II)**  
**ແບບອຸດສາຫະກຳ**  
**(Industrial Design)**

**1. ຄຳຮ້ອງ**  
**(Applications)**

**ຄຳອະທິບາຍກ່ຽວກັບລະຫັດຫຍໍ້**  
**(Introduction of Codes)**

- (21) ເລກທີ ຄຳຮ້ອງ (Filing Number)
- (22) ວັນທີ ຄຳຮ້ອງ (Filing Date)
- (30) ວັນທີ ບຸລິມາສິດ (Priority Date)
- (51) ໝວດ (Locarno Classification)
- (54) ຊື່ຂອງແບບອຸດສາຫະກຳ (Title)
- (71) ຊື່ ແລະ ທີ່ຢູ່ ຂອງເຈົ້າຂອງ (Owner Name and Address)
- (72) ຊື່ຜູ້ອອກແບບ (Designer Name)
- (74) ຊື່ຕົວແທນ (Representative Name)
- (55) ຮູບພາບ (Pictures)

## ພາກທີ II

### (Part II)

## ແບບອຸດສາຫະກຳ (Industrial Design)

### 2. ຜົນການຈົດທະບຽນ (Registration)

#### ຄຳອະທິບາຍກ່ຽວກັບລະຫັດຫຍໍ້ (Introduction of Codes)

- (11) ເລກທີ ຈົດທະບຽນ (Registration Number)
- (15) ວັນທີ ຈົດທະບຽນ (Registration Date)
- (21) ເລກທີ ຍືນຄຳຮ້ອງ (Filing Number)
- (22) ວັນທີ ຍືນຄຳຮ້ອງ (Filing Date)
- (30) ວັນທີ ບຸລິມາສິດ (Priority Date)
- (17) ວັນທີ ໝົດອາຍຸ (Expiration Date)
- (51) ໝວດ (Locarno Classification)
- (54) ຊື່ຂອງແບບອຸດສາຫະກຳ (Title)
- (71) ຊື່ ແລະ ທີ່ຢູ່ ຂອງເຈົ້າຂອງ (Owner Name and Address)
- (72) ຊື່ຜູ້ອອກແບບ (Designer Name)
- (74) ຊື່ຕົວແທນ (Representative Name)
- (55) ຮູບພາບ (Pictures)

- |      |  |      |            |
|------|--|------|------------|
| (11) | No. 638  | (21) | ID 638     |
| (15) | 03/04/2024   | (22) | 17/10/2023 |
| (28) |  | (17) | 17/10/2028 |
| (30) | 2302004254 29/09/2023 TH   | (51) | 07-02      |
| (54) | Coffee Machine   |      |            |
| (71) | PEN K Inter Trading Co., Ltd.<br>1000/63-64 P.B. Tower 16th Floor, Sukhumvit 71 Road, Klongton Nua, Wattana, Bangkok<br>10110, Thailand. |      |            |
| (72) | Ms. Dujjan Suensilpong.  |      |            |
| (74) | Lao Trademark Agency (LAO IP AGENCY).  |      |            |
| (55) |  |      |            |





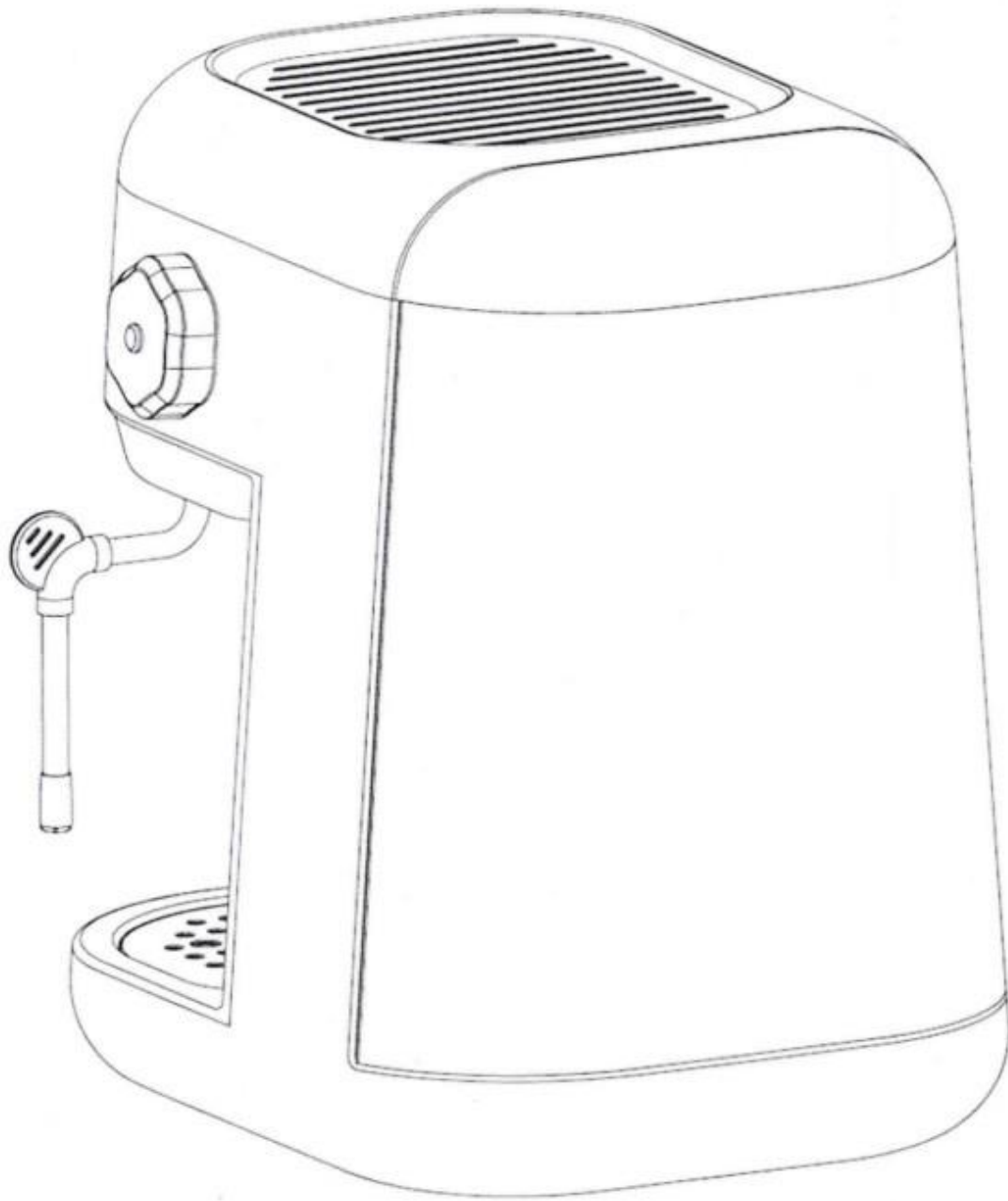

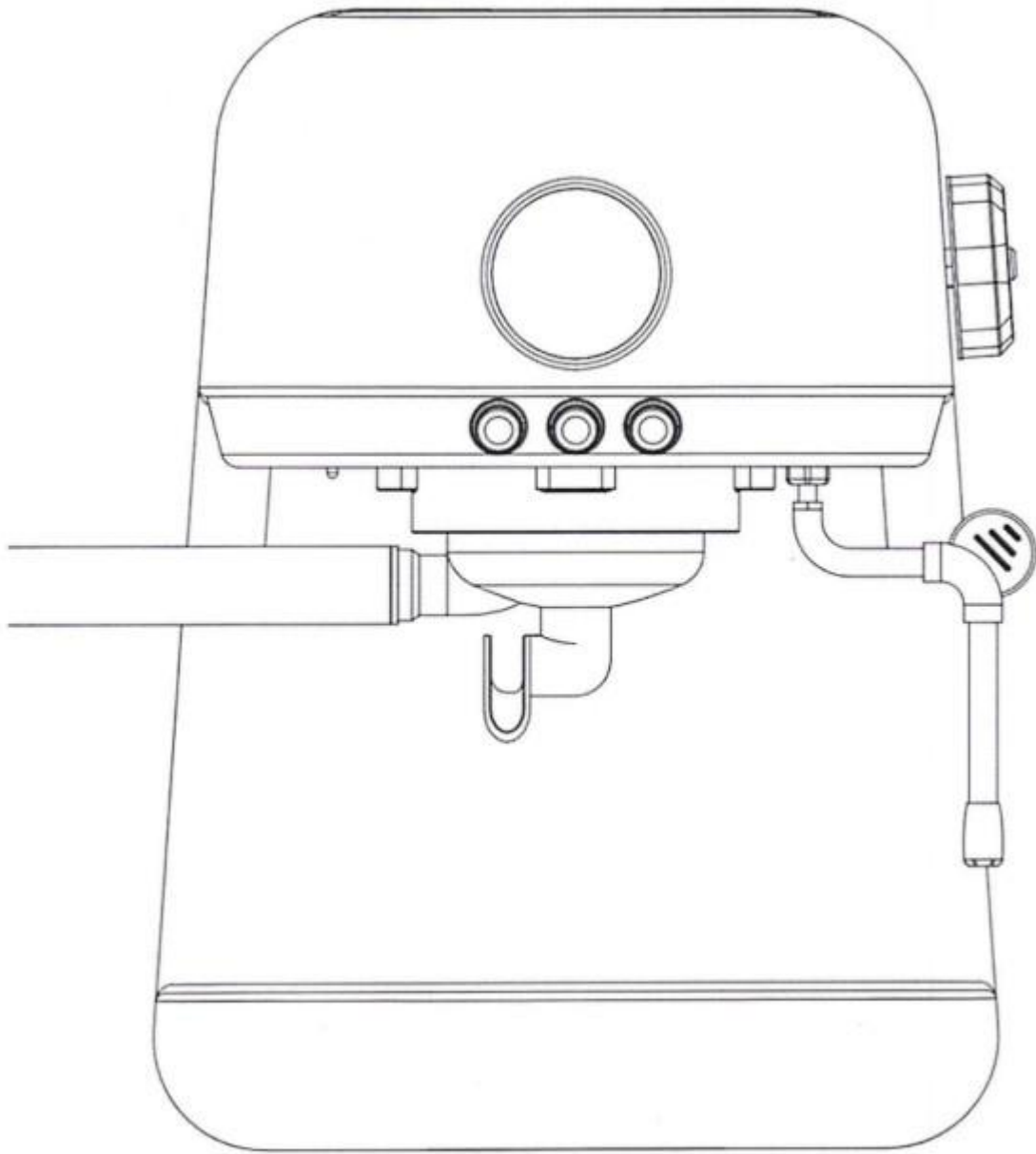

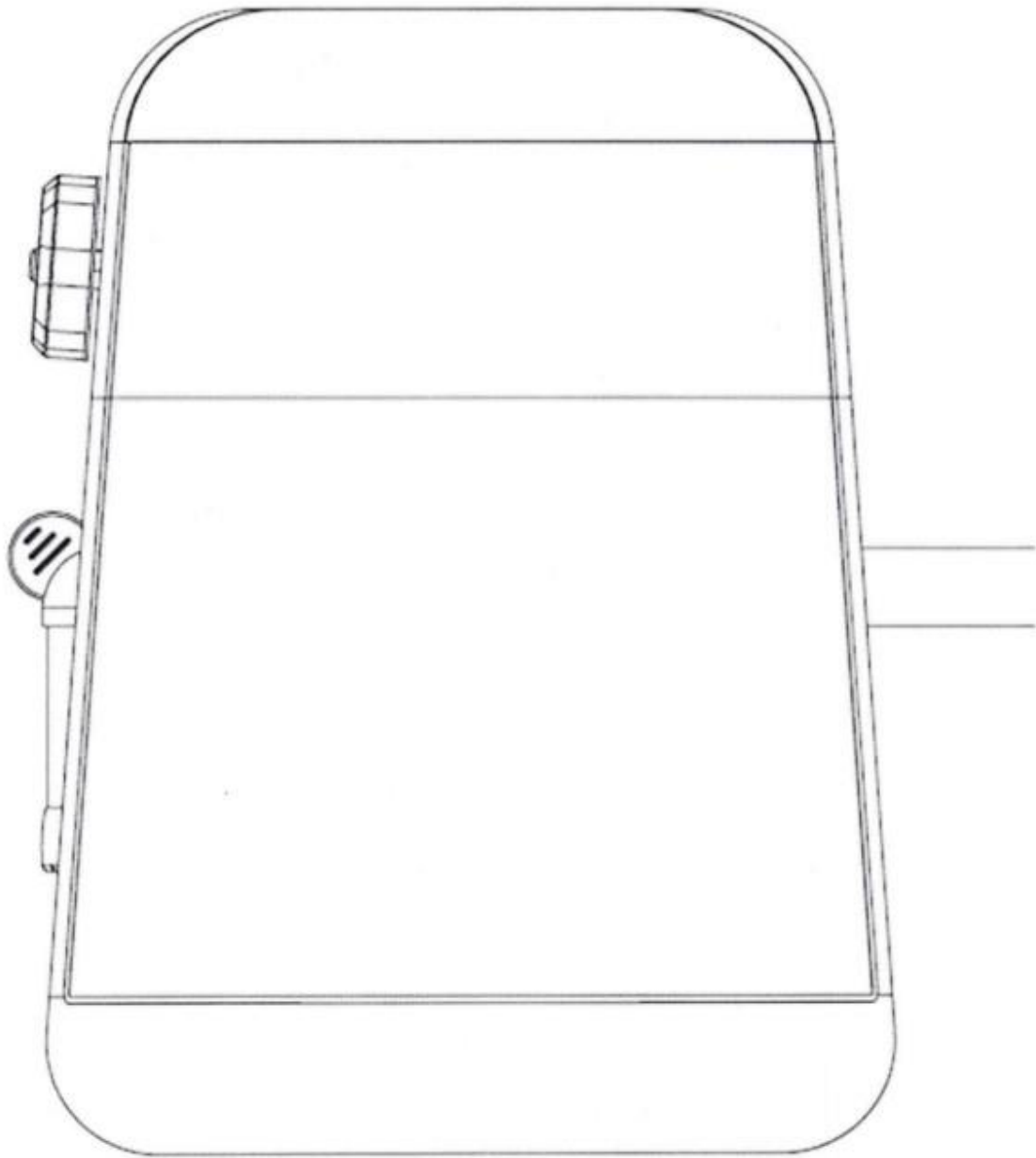

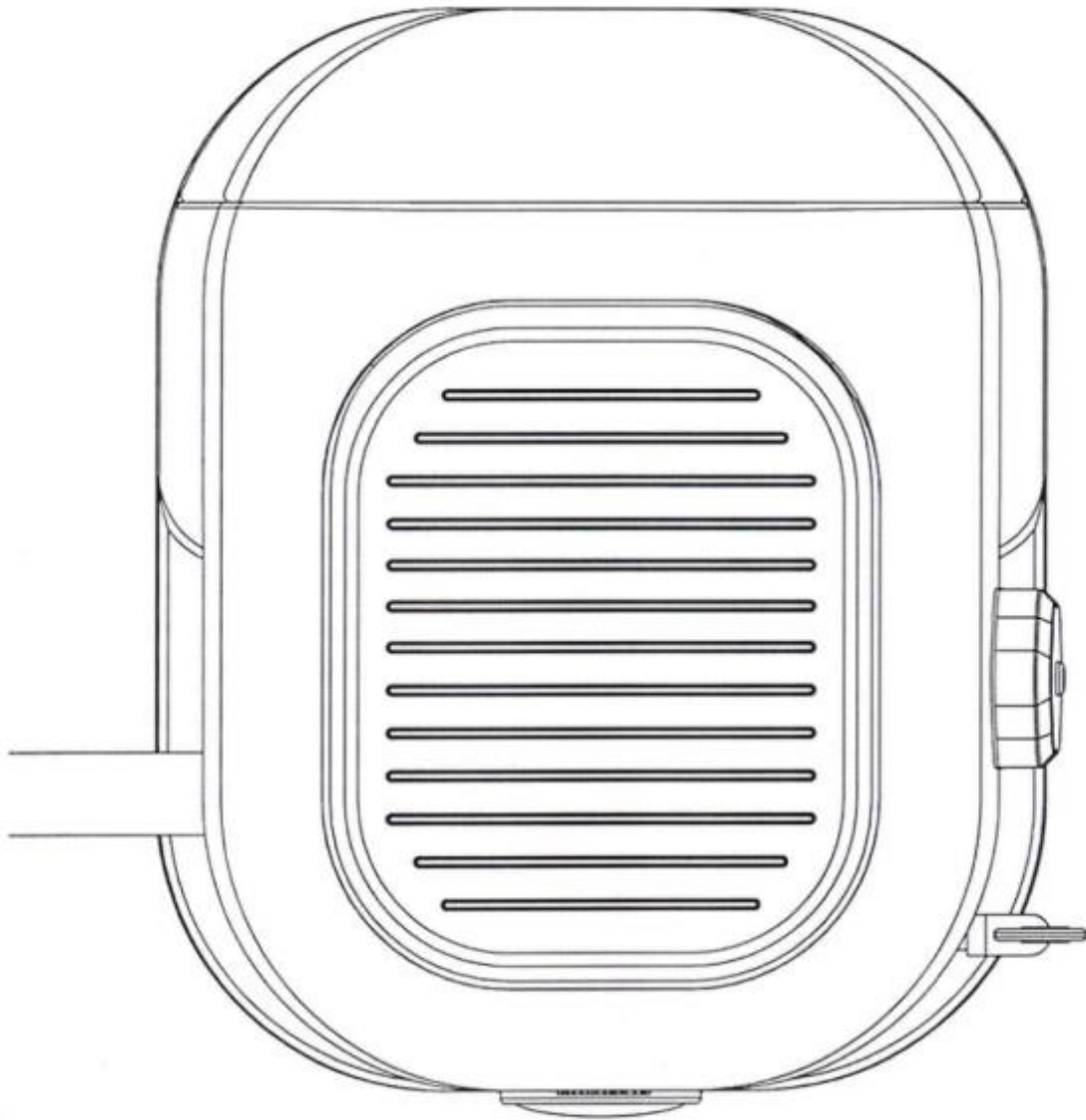

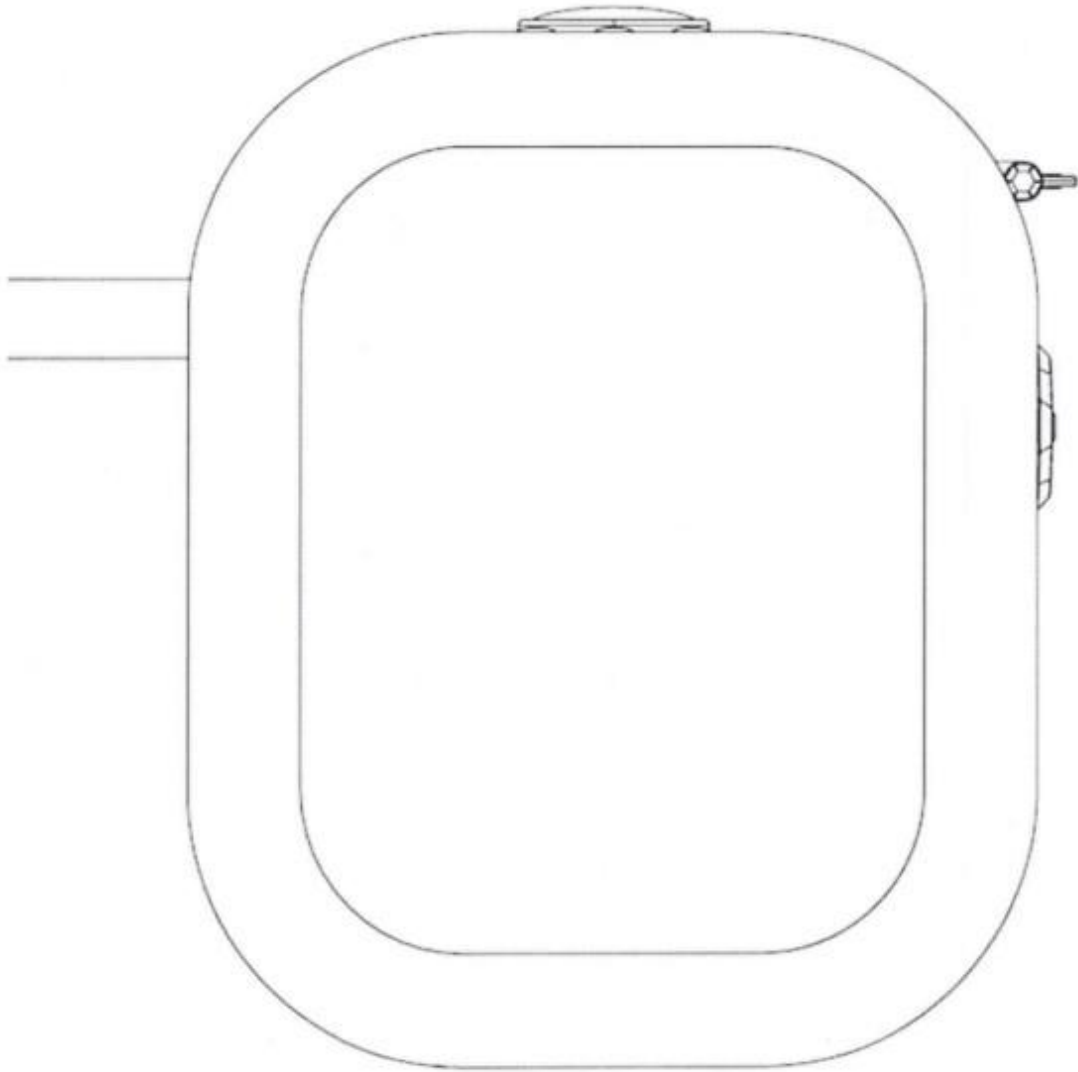

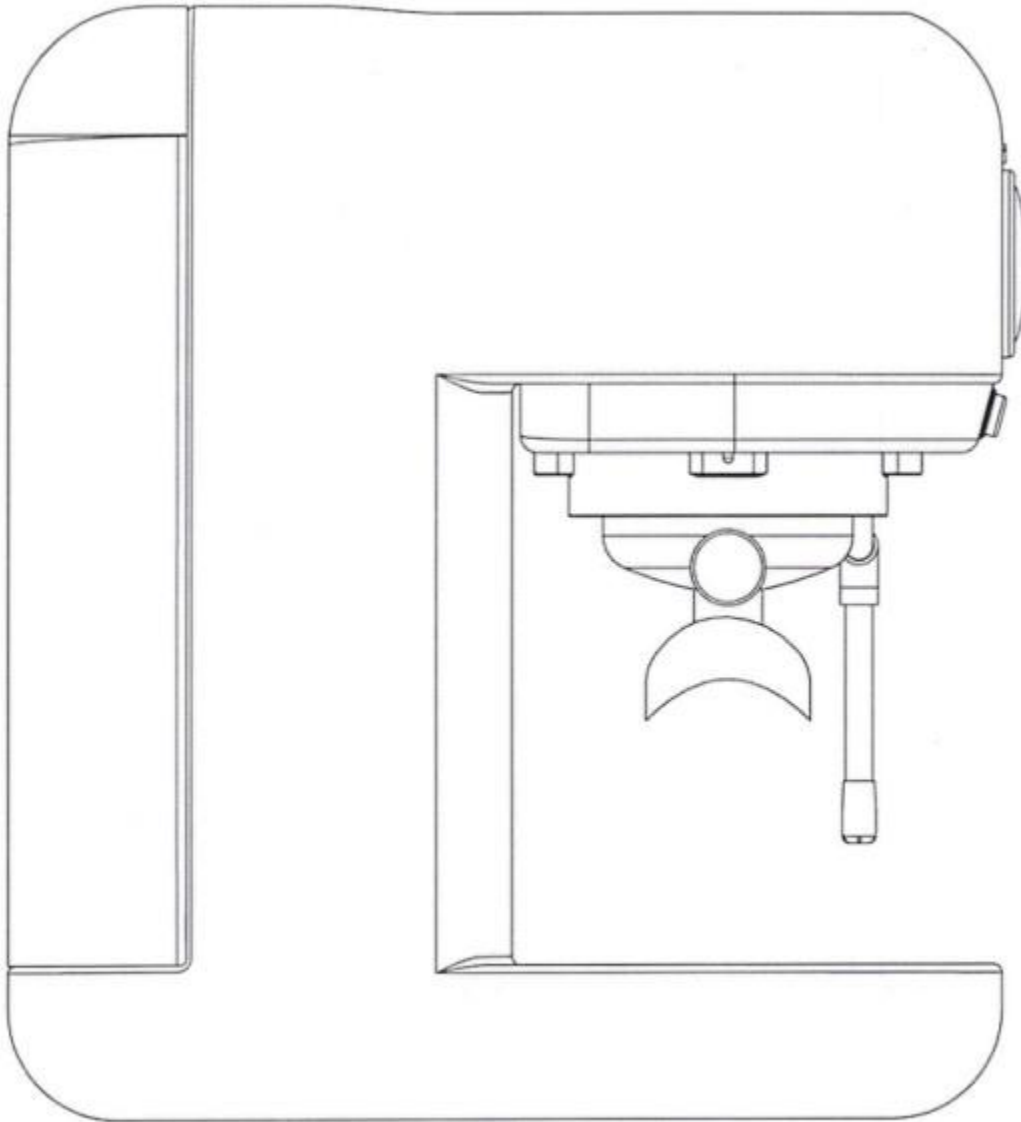

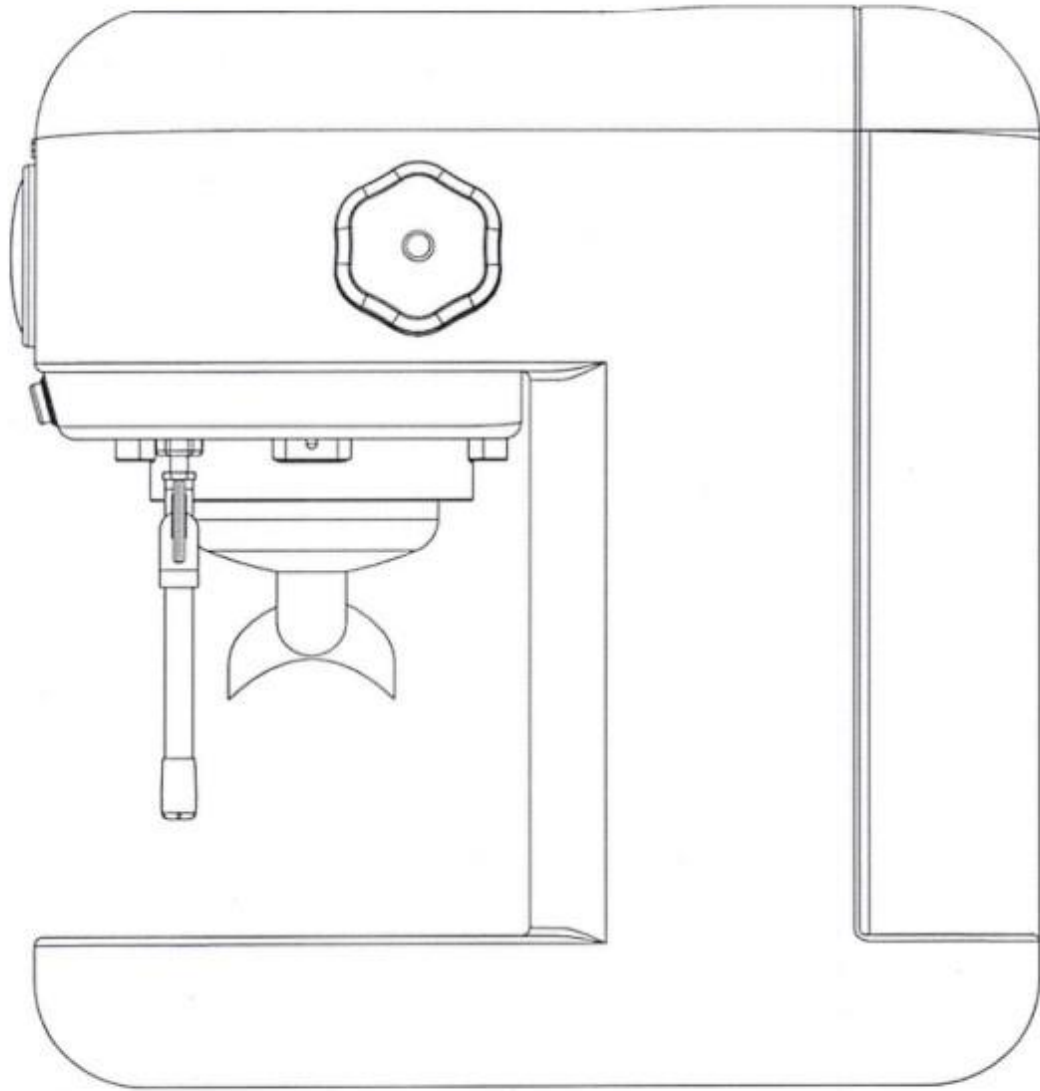

- |      |  |      |            |
|------|--|------|------------|
| (11) | No. 639  | (21) | ID 639     |
| (15) | 03/04/2024   | (22) | 22/11/2023 |
| (28) |  | (17) | 22/11/2028 |
| (30) | 3-2023-01159 26/05/2023 VN   | (51) | 12-08      |
| (54) | AUTOMOBILE   |      |            |
| (71) | Vinfast Trading and Production Joint Stock Company Dinh Vu - Cat Hai Economic Zone, Cat Hai Island, Cat Hai Town, Cat Hai District, Hai Phong City, Vietnam. |      |            |
| (72) | Joao Marcos dc Oliveira Ramos; Jae Hoon Lee; Justin James Thompson and Adam Ty Dean Smith.   |      |            |
| (74) | Lao Trademark Agency (LAO IP AGENCY).  |      |            |
| (55) |  |      |            |

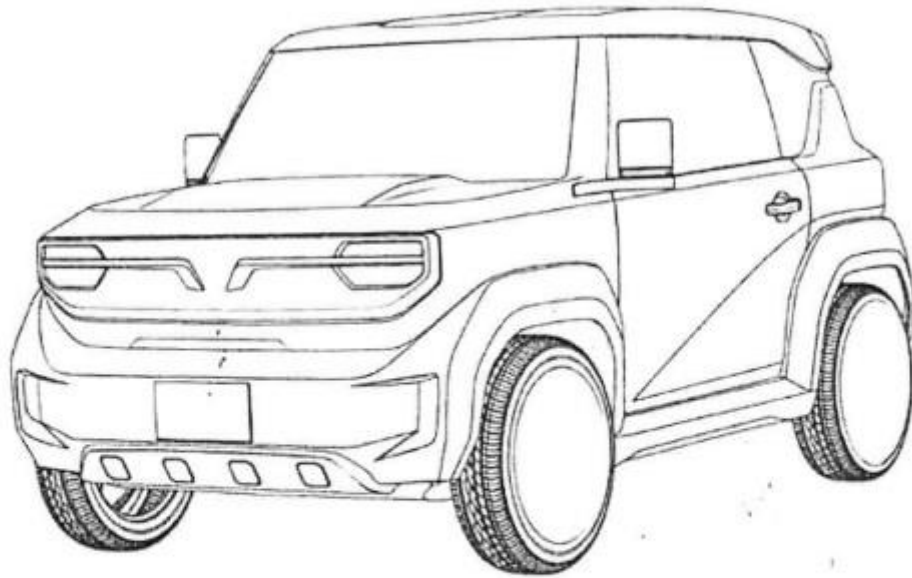

**Fig. 1**



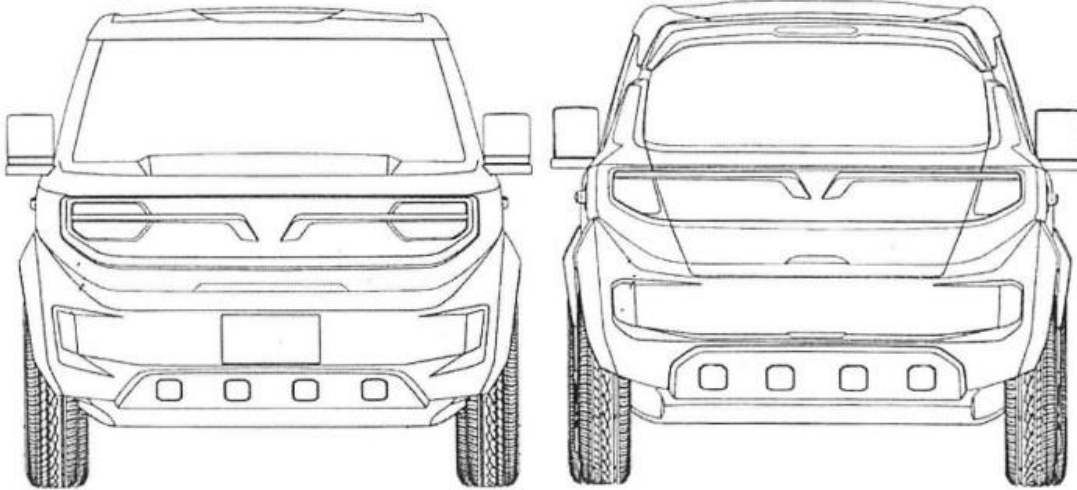

**Fig. 2**

**Fig. 3**

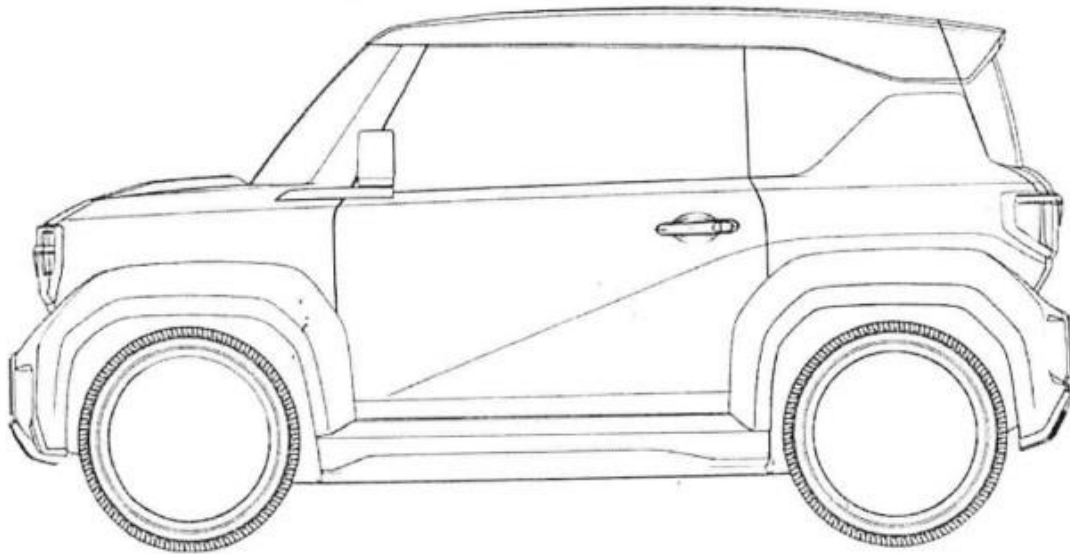

**Fig. 4**

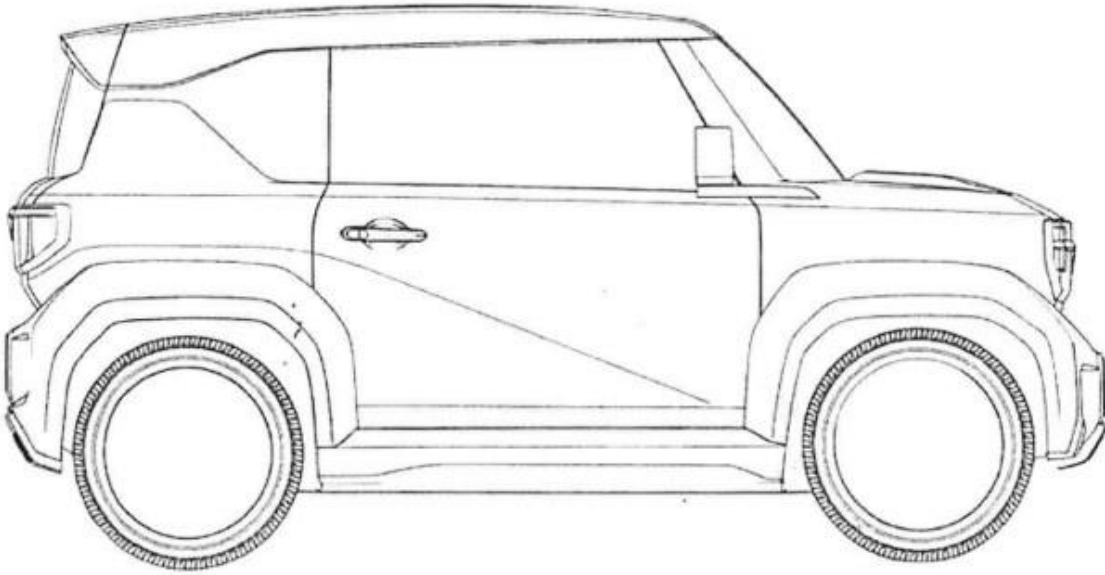

Fig. 5

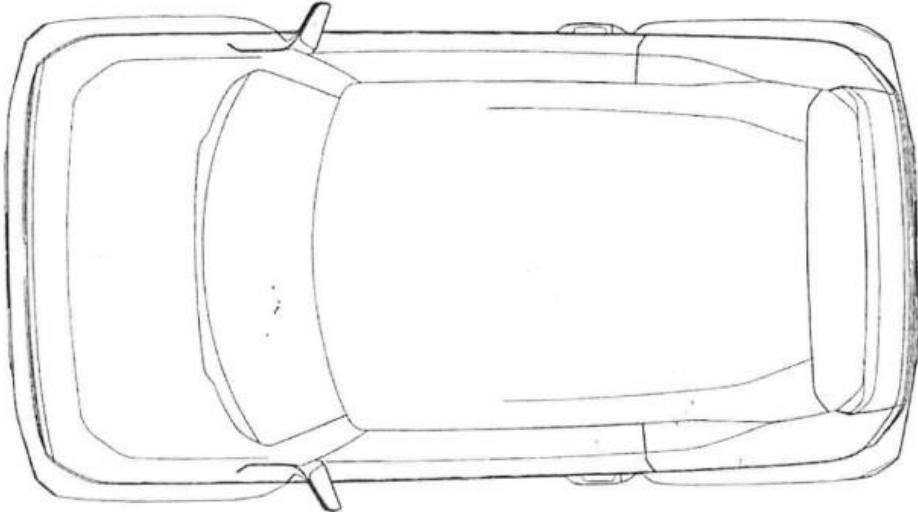

Fig. 6

**ພາກທີ II**

**(Part II)**

**ແບບອຸດສາຫະກຳ**

**(Industrial Design)**

**3. ການປ່ຽນແປງ**

**(Changes)**

**ພາກທີ II**  
**(Part II)**

**ແບບອຸດສາຫະກຳ**  
**(Industrial Design)**

**4. ການດັດແກ້**  
**(Amendments)**

## ພາກທີ III

### (Part III)

## ເຄື່ອງໝາຍການຄ້າ

### Trademarks

#### 1. ຄໍາຮ້ອງ

#### (Applications)

##### ຄໍາອະທິບາຍກ່ຽວກັບລະຫັດຫຍໍ້

##### (Introduction of Codes)

- (540) ເຄື່ອງໝາຍການຄ້າ (Trademark)
- (511) ໝວດ (Nice Classification)
- (210) ເລກທີ ຄໍາຮ້ອງ (Number of the application)
- (220) ວັນທີ ຄໍາຮ້ອງ (Date of filing of the application)
- (732) ຊື່ ແລະ ທີ່ຢູ່ ຂອງຜູ້ຍື່ນຄໍາຮ້ອງ (Name and Address of applicant)

( 540 )

**TIFFANY ASTRO**

(511) 30

(210) No. 46968

(220) 09/05/2022

(732) INTERNATIONAL FOODSTUFFS CO.  
LLC

AL-WAHDA STR-EET, INDTISTRAL  
AREA NO. 1, P.O. BOX 4115, SHARJAH,  
UNITED ARAB EMIRATES.

( 540 )

  
**LUCKYCUP**

(511) 43

(210) No. 48606

(220) 07/07/2023

(732) MIXUEBINGCHENG CO., LTD.

Room 16004, Block A, Hanhaibeijin Business  
Center, North 3rd Ring Wenhua Road, Jinshui  
District, Zhengzhou City, Henan Province,  
China.

( 540 )



(511) 05

(210) No. 48681

(220) 14/07/2023

(732) ບໍລິສັດ ອັກໂຊ ການຢາ ຈຳກັດ

ຖະໜົນ: ໂພນສະຫວ່າງ, ບ້ານ ໂພນສະຫວ່າງ, ເມືອງ

ຈັນທະບູລີ, ນະຄອນຫຼວງວຽງຈັນ, ສປປ ລາວ

( 540 )



(511) 12

(210) No. 48698

(220) 19/07/2023

(732) JIANGSU GUGAO AUTOPARTS CO.,LTD

DEXIANG ROAD, JIEPAI TOWN,

DANYANG, JIANGSU, CHINA 212323.

( 540 )



(511) 03

(210) No. 49027

(220) 02/10/2023

(732) NEO FACTORY COMPANY LIMITED

168 Moo 5 Bueng Kho Hai, Lamlukka,  
Pathumthani 12150, Thailand.

( 540 )



(511) 03

(210) No. 49028

(220) 02/10/2023

(732) NEO FACTORY COMPANY LIMITED

168 Moo 5 Bueng Kho Hai, Lamlukka,  
Pathumthani 12150, Thailand.



( 540 )

The logo for 'Smart' features the word in a blue, sans-serif font. Behind the letters, there is a stylized graphic of a shield or a globe with a white outline and a blue gradient fill.

(511) 03

(210) No. 49029

(220) 02/10/2023

(732) NEO FACTORY COMPANY LIMITED

168 Moo 5 Bueng Kho Hai, Lamlukka,  
Pathumthani 12150, Thailand.

( 540 )

The logo for 'Vivite' features the word in a green, cursive script font. To the right of the word is a stylized green leaf with a white vein.

(511) 03

(210) No. 49030

(220) 02/10/2023

(732) NEO FACTORY COMPANY LIMITED

168 Moo 5 Bueng Kho Hai, Lamlukka,  
Pathumthani 12150, Thailand.

( 540 )

芙龙玉 FULONGYU

(511) 34

(210) No. 49031

(220) 03/10/2023

(732) ບໍລິສັດຢາສຸບລາວທຽນຫຼິງຈຳກັດ

ບ້ານ ບໍ່ປຽດ, ເມືອງ ຫຼວງນ້ຳທາ, ແຂວງ ຫຼວງນ້ຳທາ,  
ສປປ ລາວ

( 540 )



(511) 09 and 35

(210) No. 49032

(220) 04/10/2023

(732) ບໍລິສັດ ຢຸດລ ການຄ້າ ເຄື່ອງໃຊ້ໃນຄົວເຮືອນ

ຈຳກັດຜູ້ດຽວ

ບ້ານນາບຽນ, ເມືອງໄຊເສດຖາ, ນະຄອນຫຼວງວຽງຈັນ,  
ສປປ ລາວ

( 540 )



(511) 35 and 36

(210) No. 49033

(220) 05/10/2023

(732) KASIKORNBANK PUBLIC COMPANY  
LIMITED

No. 400/22 Phahon Yothin Road, Sam Sen  
Nai Sub-District, Phaya Thai District  
Bangkok, Thailand.

( 540 )

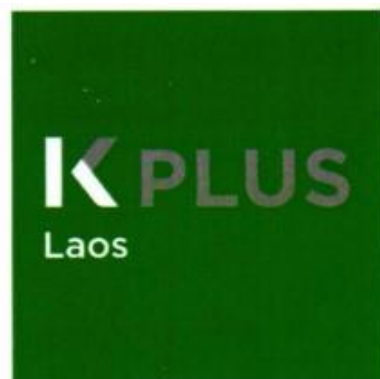

(511) 35 and 36

(210) No. 49034

(220) 05/10/2023

(732) KASIKORNBANK PUBLIC COMPANY  
LIMITED

No. 400/22 Phahon Yothin Road, Sam Sen  
Nai Sub-District, Phaya Thai District  
Bangkok, Thailand.

( 540 )



(511) 35 and 36

(210) No. 49035

(220) 05/10/2023

(732) KASIKORNBANK PUBLIC COMPANY  
LIMITED

No. 400/22 Phahon Yothin Road, Sam Sen  
Nai Sub-District, Phaya Thai District  
Bangkok, Thailand.

( 540 )



(511) 35 and 36

(210) No. 49036

(220) 05/10/2023

(732) KASIKORNBANK PUBLIC COMPANY  
LIMITED

No. 400/22 Phahon Yothin Road, Sam Sen  
Nai Sub-District, Phaya Thai District  
Bangkok, Thailand.

( 540 )



(511) 35 and 36

(210) No. 49037

(220) 05/10/2023

(732) KASIKORNBANK PUBLIC COMPANY  
LIMITED

No. 400/22 Phahon Yothin Road, Sam Sen  
Nai Sub-District, Phaya Thai District  
Bangkok, Thailand.

( 540 )



(511) 35 and 36

(210) No. 49038

(220) 05/10/2023

(732) KASIKORNBANK PUBLIC COMPANY  
LIMITED

No. 400/22 Phahon Yothin Road, Sam Sen  
Nai Sub-District, Phaya Thai District  
Bangkok, Thailand.

( 540 )



(511) 35 and 36

(210) No. 49039

(220) 05/10/2023

(732) KASIKORNBANK PUBLIC COMPANY  
LIMITED

No. 400/22 Phahon Yothin Road, Sam Sen  
Nai Sub-District, Phaya Thai District  
Bangkok, Thailand.

( 540 )



(511) 35 and 36

(210) No. 49040

(220) 05/10/2023

(732) KASIKORNBANK PUBLIC COMPANY  
LIMITED

No. 400/22 Phahon Yothin Road, Sam Sen  
Nai Sub-District, Phaya Thai District  
Bangkok, Thailand.

( 540 )

**K PLUS**  
Laos

(511) 35 and 36

(210) No. 49041

(220) 05/10/2023

(732) KASIKORNBANK PUBLIC COMPANY  
LIMITED

No. 400/22 Phahon Yothin Road, Sam Sen  
Nai Sub-District, Phaya Thai District  
Bangkok, Thailand.

( 540 )

**K PLUS**  
Laos

(511) 35 and 36

(210) No. 49042

(220) 05/10/2023

(732) KASIKORNBANK PUBLIC COMPANY  
LIMITED

No. 400/22 Phahon Yothin Road, Sam Sen  
Nai Sub-District, Phaya Thai District  
Bangkok, Thailand.

( 540 )

The logo for K+Laos, featuring a stylized 'K' followed by a plus sign and the word 'Laos'.

(511) 35 and 36

(210) No. 49043

(220) 05/10/2023

(732) KASIKORNBANK PUBLIC COMPANY  
LIMITED

No. 400/22 Phahon Yothin Road, Sam Sen  
Nai Sub-District, Phaya Thai District  
Bangkok, Thailand.

( 540 )

The logo for K+Laos, featuring a stylized 'K' followed by a plus sign and the word 'Laos'.

(511) 35 and 36

(210) No. 49044

(220) 05/10/2023

(732) KASIKORNBANK PUBLIC COMPANY  
LIMITED

No. 400/22 Phahon Yothin Road, Sam Sen  
Nai Sub-District, Phaya Thai District  
Bangkok, Thailand.



( 540 )



(511) 35 and 36

(210) No. 49045

(220) 05/10/2023

(732) KASIKORNBANK PUBLIC COMPANY  
LIMITED

No. 400/22 Phahon Yothin Road, Sam Sen  
Nai Sub-District, Phaya Thai District  
Bangkok, Thailand.

( 540 )



(511) 35 and 36

(210) No. 49046

(220) 05/10/2023

(732) KASIKORNBANK PUBLIC COMPANY  
LIMITED

No. 400/22 Phahon Yothin Road, Sam Sen  
Nai Sub-District, Phaya Thai District  
Bangkok, Thailand.

( 540 )



(511) 35 and 36

(210) No. 49047

(220) 05/10/2023

(732) KASIKORNBANK PUBLIC COMPANY  
LIMITED

No. 400/22 Phahon Yothin Road, Sam Sen  
Nai Sub-District, Phaya Thai District  
Bangkok, Thailand.

( 540 )



(511) 35 and 36

(210) No. 49048

(220) 05/10/2023

(732) KASIKORNBANK PUBLIC COMPANY  
LIMITED

No. 400/22 Phahon Yothin Road, Sam Sen  
Nai Sub-District, Phaya Thai District  
Bangkok, Thailand.

( 540 )

Pilot Pro

(511) 03

(210) No. 49049

(220) 05/10/2023

(732) ບໍລິສັດ ທີຊີເອັນ ຂາເຂົ້າ-ຂາອອກ ຈຳກັດຜູ້ດຽວ

ບ້ານ ດົງໂພສີ ເມືອງ ຫາດຊາຍຝອງ,

ນະຄອນຫຼວງວຽງຈັນ, ສປປ ລາວ

( 540 )



(511) 03, 16 and 29

(210) No. 49050

(220) 05/10/2023

(732) ບໍລິສັດ ຕະຫຼາດສຸກສິມບຸນ ຈຳກັດຜູ້ດຽວ

ຖະໜົນ 13 ໃຕ້, ບ້ານໜອງບົວຄຳ, ເມືອງທ່າແຂກ,

ແຂວງຄຳມ່ວນ, ສປປ ລາວ

( 540 )

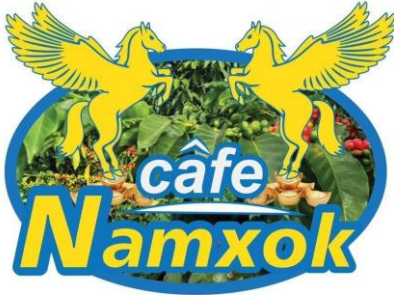

(511) 30

(210) No. 49051

(220) 05/10/2023

(732) ວິສາຫະກິດ ຄາເຟ ນຳໂຊກ ສ່ວນບຸກຄົນ

ບ້ານ ຕົ້ນຜົງ, ເມືອງ ຕົ້ນຜົງ, ແຂວງ ບໍ່ແກ້ວ,  
ສປປ ລາວ

( 540 )



(511) 29

(210) No. 49052

(220) 06/10/2023

(732) All Corporation Limited

No. 119 Tara Sathorn Building, South  
Sathorn Road, Thungmahamek Sathorn,  
Bangkok, Thailand.

( 540 )



(511) 30

(210) No. 49053

(220) 06/10/2023

(732) All Corporation Limited

No. 119 Tara Sathorn Building, South  
Sathorn Road, Thungmahamek Sathorn,  
Bangkok, Thailand.

( 540 )



(511) 29

(210) No. 49054

(220) 06/10/2023

(732) All Corporation Limited

No. 119 Tara Sathorn Building, South  
Sathorn Road, Thungmahamek Sathorn,  
Bangkok, Thailand.

( 540 )



(511) 30

(210) No. 49055

(220) 06/10/2023

(732) All Corporation Limited

No. 119 Tara Sathorn Building, South  
Sathorn Road, Thungmahamek Sathorn,  
Bangkok, Thailand.

( 540 )



(511) 29

(210) No. 49056

(220) 06/10/2023

(732) All Corporation Limited

No. 119 Tara Sathorn Building, South  
Sathorn Road, Thungmahamek Sathorn,  
Bangkok, Thailand.

( 540 )



(511) 30

(210) No. 49057

(220) 06/10/2023

(732) All Corporation Limited

No. 119 Tara Sathorn Building, South  
Sathorn Road, Thungmahamek Sathorn,  
Bangkok, Thailand.

( 540 )



(511) 03

(210) No. 49058

(220) 06/10/2023

(732) All Corporation Limited

No. 119 Tara Sathorn Building, South  
Sathorn Road, Thungmahamek Sathorn,  
Bangkok, Thailand.

( 540 )



(511) 05

(210) No. 49059

(220) 06/10/2023

(732) All Corporation Limited

No. 119 Tara Sathorn Building, South  
Sathorn Road, Thungmahamek Sathorn,  
Bangkok, Thailand.

( 540 )



(511) 08

(210) No. 49060

(220) 06/10/2023

(732) All Corporation Limited

No. 119 Tara Sathorn Building, South  
Sathorn Road, Thungmahamek Sathorn,  
Bangkok, Thailand.



( 540 )



(511) 10

(210) No. 49061

(220) 06/10/2023

(732) All Corporation Limited

No. 119 Tara Sathorn Building, South  
Sathorn Road, Thungmahamek Sathorn,  
Bangkok, Thailand.

( 540 )



(511) 14

(210) No. 49062

(220) 06/10/2023

(732) All Corporation Limited

No. 119 Tara Sathorn Building, South  
Sathorn Road, Thungmahamek Sathorn,  
Bangkok, Thailand.

( 540 )



(511) 16

(210) No. 49063

(220) 06/10/2023

(732) All Corporation Limited

No. 119 Tara Sathorn Building, South  
Sathorn Road, Thungmahamek Sathorn,  
Bangkok, Thailand.

( 540 )



(511) 18

(210) No. 49064

(220) 06/10/2023

(732) All Corporation Limited

No. 119 Tara Sathorn Building, South  
Sathorn Road, Thungmahamek Sathorn,  
Bangkok, Thailand.

( 540 )



(511) 21

(210) No. 49065

(220) 06/10/2023

(732) All Corporation Limited

No. 119 Tara Sathorn Building, South  
Sathorn Road, Thungmahamek Sathorn,  
Bangkok, Thailand.

( 540 )



(511) 25

(210) No. 49066

(220) 06/10/2023

(732) All Corporation Limited

No. 119 Tara Sathorn Building, South  
Sathorn Road, Thungmahamek Sathorn,  
Bangkok, Thailand.

( 540 )



(511) 26

(210) No. 49067

(220) 06/10/2023

(732) All Corporation Limited

No. 119 Tara Sathorn Building, South  
Sathorn Road, Thungmahamek Sathorn,  
Bangkok, Thailand.

( 540 )



(511) 34

(210) No. 49068

(220) 06/10/2023

(732) All Corporation Limited

No. 119 Tara Sathorn Building, South  
Sathorn Road, Thungmahamek Sathorn,  
Bangkok, Thailand.

( 540 )



(511) 34

(210) No. 49069

(220) 05/10/2023

(732) ບໍລິສັດ ເຕັກໂນໂລຊີໃໝ່ ຂາອອກ-ຂາເຂົ້າ

ຈຳກັດຜູ້ດຽວ

ບ້ານ ລ້ອງກູ້, ເມືອງ ວຽງໄຊ, ແຂວງ ຫົວພັນ,

ສປປ ລາວ

( 540 )

**SUMO**

(511) 03

(210) No. 49070

(220) 06/10/2023

(732) CONG TY TNHH SX-TM-DV SUMO

(SUMO SX-TM-DV CO., LTD)

18-20-22 Le Lang Sheet, Phu Tho Hoa Ward,

Tan Phu District, Ho Chi Minh City,

Vietnam.

( 540 )

**FION**

(511) 03

(210) No. 49071

(220) 06/10/2023

(732) CONG TY TNHH SX-TM-DV SUMO

(SUMO SX-TM-DV CO., LTD)

18-20-22 Le Lang Sheet, Phu Tho Hoa Ward,  
Tan Phu District, Ho Chi Minh City,  
Vietnam.

( 540 )

**TEADONG**

(511) 16

(210) No. 49072

(220) 09/10/2023

(732) JIDONG (SHANG HAI) F&B

MANAGEMENT CO., LTD

Room 111, Building 7, No. 429, Quwu Road,  
Minhang District, Shanghai, China.

( 540 )

**TEADONG**

(511) 29

(210) No. 49073

(220) 09/10/2023

(732) JIDONG (SHANG HAI) F&B

MANAGEMENT CO., LTD

Room 111, Building 7, No. 429, Quwu Road,  
Minhang District, Shanghai, China.

( 540 )

**TEADONG**

(511) 30

(210) No. 49074

(220) 09/10/2023

(732) JIDONG (SHANG HAI) F&B

MANAGEMENT CO., LTD

Room 111, Building 7, No. 429, Quwu Road,  
Minhang District, Shanghai, China.

( 540 )

**TEADONG**

(511) 32

(210) No. 49075

(220) 09/10/2023

(732) JIDONG (SHANG HAI) F&B

MANAGEMENT CO., LTD

Room 111, Building 7, No. 429, Quwu Road,  
Minhang District, Shanghai, China.

( 540 )

**TEADONG**

(511) 33

(210) No. 49076

(220) 09/10/2023

(732) JIDONG (SHANG HAI) F&B

MANAGEMENT CO., LTD

Room 111, Building 7, No. 429, Quwu Road,  
Minhang District, Shanghai, China.



( 540 )

**TEADONG**

(511) 35

(210) No. 49077

(220) 09/10/2023

(732) JIDONG (SHANG HAI) F&B

MANAGEMENT CO., LTD

Room 111, Building 7, No. 429, Quwu Road,  
Minhang District, Shanghai, China.

( 540 )

**TEADONG**

(511) 43

(210) No. 49078

(220) 09/10/2023

(732) JIDONG (SHANG HAI) F&B

MANAGEMENT CO., LTD

Room 111, Building 7, No. 429, Quwu Road,  
Minhang District, Shanghai, China.

( 540 )

**HONP-Z**

(511) 18

(210) No. 49079

(220) 09/10/2023

(732) GUANGZHOU SANSHI LEATHER CO.,  
LTD.

707-708. No.4-2, Lvgang 7th St,Greenland  
Airport International Center,Huadu  
Dist,Guangzhou city, Guangdong Province,  
China.

( 540 )

**HONP-Z**

(511) 25

(210) No. 49080

(220) 09/10/2023

(732) GUANGZHOU SANSHI LEATHER CO.,  
LTD.

707-708, No.4-2, Lvgang 7th St,Greenland  
Airport International Center,Huadu  
Dist,Guangzhou city, Guangdong Province,  
China.

( 540 )

REFRIGIWEAR

(511) 25

(210) No. 49081

(220) 09/10/2023

(732) REFRIGIWEAR, LLC

54 Breakstone Drive, Dahlonega, Georgia  
30533, United States of America.

( 540 )



(511) 25

(210) No. 49082

(220) 09/10/2023

(732) REFRIGIWEAR, LLC

54 Breakstone Drive, Dahlonega, Georgia  
30533, United States of America.

( 540 )



(511) 32

(210) No. 49083

(220) 10/10/2023

(732) GRUPO EMBOTELLADOR ATIC, S.A.

Avenida De La Vega, 1 Edificio 2 Planta 5  
CP 28108, Alcobendas, Madrid, Spain.

( 540 )



(511) 32

(210) No. 49084

(220) 10/10/2023

(732) GRUPO EMBOTELLADOR ATIC, S.A.

Avenida De La Vega, 1 Edificio 2 Planta 5  
CP 28108, Alcobendas, Madrid, Spain.

( 540 )

**EESASIA**

(511) 07

(210) No. 49085

(220) 10/10/2023

(732) Weizhong Xu

No. 265, Jiangdong Middle Road, Jianye  
District, Nanjing City, Jiangsu Province,,  
China.

( 540 )

**GOTDYA**

(511) 03

(210) No. 49086

(220) 10/10/2023

(732) Guangzhou Gotdya Fine Chemical Co., Ltd.

Tuanjie No.1 Industrial Park, Datangkou  
Economic Cooperative, Tuanjie Village,  
Xinya Street, Huadu District, Guangzhou,  
510800, P.R, China.

( 540 )

**iNOMA**

(511) 12

(210) No. 49087

(220) 10/10/2023

(732) Mitsubishi Logisnext Co., Ltd.

1-1, 2-Chome, Higashikotari, Nagaokakyo-  
shi, Kyoto, Japan.

( 540 )



(511) 05

(210) No. 49088

(220) 11/10/2023

(732) Kiat Meliana Widya Kusuma

Jl. Golf View No.58, RT. 007/RW. 008,  
Bencongan Indah, Kelapa Dua, Tangerang,  
Banten, Indonesia.

( 540 )



(511) 06, 07 and 11

(210) No. 49089

(220) 11/10/2023

(732) MR ZENG YUNTAO

ບ້ານວັດໂຕນ້ອຍທົ່ງ, ເມືອງ ສີໂຄດຕະບອງ,  
ນະຄອນຫຼວງວຽງຈັນ, ສປປ ລາວ

( 540 )



(511) 06, 07 and 11

(210) No. 49090

(220) 11/10/2023

(732) MR ZENG YUNTAO

ບ້ານວັດໂຕນ້ອຍທົ່ງ, ເມືອງ ສີໂຄດຕະບອງ,  
ນະຄອນຫຼວງວຽງຈັນ, ສປປ ລາວ

( 540 )



(511) 36

(210) No. 49091

(220) 11/10/2023

(732) ບໍລິສັດ ລາດຊະວົງ ພັດທະນາ ຈຳກັດ

ບ້ານ ຈອມມະນີ, ເມືອງ ໄຊເສດຖາ,

ນະຄອນຫຼວງວຽງຈັນ, ສປປ ລາວ

( 540 )

**ORMEO**

(511) 07, 11, 21 and 35

(210) No. 49092

(220) 11/10/2023

(732) Guangdong Huasheng Intelligent Electrical  
Appliance Co., Ltd.

Rm.701, Bldg.11, Ronggui Wei'an Science  
& Innovation Park, NO.16, Guangxing Rd.,  
Hongxing community, Ronggui St., Shunde  
Dist., Foshan City, Guangdong, China.



( 540 )

The logo for HUABAO, featuring the word "HUABAO" in a bold, black, sans-serif font. To the left of the text is a stylized graphic element consisting of three horizontal, slightly curved lines that resemble a wave or a stylized 'H'.

(511) 09

(210) No. 49093

(220) 11/10/2023

(732) SHENZHEN HUABAO VIDEO

TECHNOLOGY CO., LTD

Room 2504, Building A, Building 2, Futong  
City Phase 3, Xingye Road, Fuzhongfu  
Community, Xixiang Street, Baoan District,  
Shenzhen City, China.

( 540 )

The logo for honey pet, featuring the Chinese characters "欢虎仔" (Huān Hǔ zǐ) above the English text "honey pet". The text is in a black, sans-serif font. The English text "honey pet" is underlined with a thin, curved line.

(511) 31

(210) No. 49094

(220) 11/10/2023

(732) GAMBOL PET GROUP CO., LTD.

No. 8 Mudanjiang Rd., Economic and  
Technological Development zone, Liaocheng,  
shandong Province, China.

( 540 )



(511) 31

(210) No. 49095

(220) 11/10/2023

(732) GAMBOL PET GROUP CO., LTD.

No. 8 Mudanjiang Rd., Economic and  
Technological Development zone, Liaocheng,  
shandong Province, China.

( 540 )



(511) 42

(210) No. 49096

(220) 11/10/2023

(732) BYTEBANCO HOLDING LTD.

B-1.22, DATARAN CASCADES, NO.13A,  
JALAN PJU 5/1, KOTA DAMANSARA,  
47810 PETALING JAYA, SELANGOR,  
MALAYSIA.

( 540 )



(511) 01

(210) No. 49097

(220) 12/10/2023

(732) ບໍລິສັດ ອຸດົມໄຊພັດທະນາກະສິກໍາ ຂາອອກ-ຂາເຂົ້າ

ຈຳກັດຜູ້ດຽວ

ບ້ານ ວັງໄຮ, ເມືອງໄຊ, ແຂວງອຸດົມໄຊ,

ສປປ ລາວ

( 540 )



(511) 03

(210) No. 49098

(220) 12/10/2023

(732) ຮ້ານນາງ ເມຂາຍເຄື່ອງສໍາອາງ, ຂາຍສິ່ງ ແລະ ຂາຍຍ່ອຍ

ບ້ານ ດອນໄລ່, ເມືອງໂພນທອງ, ແຂວງຈໍາປາສັກ,

ນະຄອນຫຼວງວຽງຈັນ, ສປປ ລາວ

( 540 )



(511) 09

(210) No. 49099

(220) 12/10/2023

(732) ບໍລິສັດ ຫົວຊີງ ອຸປະກອນເສີມດິຈິຕອນເອເລັກໂຕຣນິກ

ຈຳກັດຜູ້ດຽວ

ບ້ານ ດົງປາລານທ່າ, ເມືອງ ສີສັດຕະນາກ,

ນະຄອນຫຼວງວຽງຈັນ, ສປປ ລາວ

( 540 )



(511) 09

(210) No. 49100

(220) 12/10/2023

(732) ບໍລິສັດ ຫົວຊີງ ອຸປະກອນເສີມດິຈິຕອນເອເລັກໂຕຣນິກ

ຈຳກັດຜູ້ດຽວ

ບ້ານ ດົງປາລານທ່າ, ເມືອງ ສີສັດຕະນາກ,

ນະຄອນຫຼວງວຽງຈັນ, ສປປ ລາວ

( 540 )

The logo for ZEEK, featuring the letters 'Z', 'E', 'E', and 'K' in a bold, stylized, blocky font. The 'Z' and 'E's are connected, and the 'K' is separate.

(511) 12, 35, 37 and 39

(210) No. 49101

(220) 12/10/2023

(732) ATOZED OPTIMA CONSULTING  
PTE.LTD.

8 EU TONG SEN STREET #14-83 THE  
CENTRAL SINGAPORE(059818).

( 540 )

The logo for TOP TOTS, featuring the words 'TOP TOTS' in a bold, sans-serif font.

(511) 28

(210) No. 49103

(220) 13/10/2023

(732) Toys"R"Us (Asia) Limited

8/F, LiFung Tower, 888 Cheung Sha Wan  
Road, Lai Chi Kok, Kowloon, Hong Kong.

( 540 )



(511) 28

(210) No. 49104

(220) 13/10/2023

(732) Toys"R"Us (Asia) Limited

8/F, LiFung Tower, 888 Cheung Sha Wan  
Road, Lai Chi Kok, Kowloon, Hong Kong.

( 540 )



(511) 03, 14, 25, 30, 32, 35, 38, 39 and 43

(210) No. 49105

(220) 13/10/2023

(732) ບໍລິສັດ ມ່ວນໃຈ ການຄ້າ ຂາອອກ-ຂາເຂົ້າ

ຮ່ວມທຶນຈຳກັດ

ບ້ານ ພະໂພ, ເມືອງ ສີສັດຕະນາກ,

ນະຄອນຫຼວງວຽງຈັນ, ສປປ ລາວ

( 540 )



(511) 03, 14, 25, 30, 32, 35, 38, 39 and 43

(210) No. 49106

(220) 13/10/2023

(732) ບໍລິສັດ ມ່ວນໃຈ ການຄ້າ ຂາອອກ-ຂາເຂົ້າ

ຮ່ວມທຶນຈຳກັດ

ບ້ານ ພະໂພ, ເມືອງ ສີສັດຕະນາກ,

ນະຄອນຫຼວງວຽງຈັນ, ສປປ ລາວ

( 540 )



(511) 11

(210) No. 49107

(220) 13/10/2023

(732) IDEAL SANITARY WARE CO., LTD.

No. 204 Hongling Road, Shishan Town,

Nanhai District, Foshan, Guangdong, China.

( 540 )

**ZEEK**

(511) 12, 35, 37 and 39

(210) No. 49108

(220) 16/10/2023

(732) ATOZED OPTIMA CONSULTING  
PTE.LTD.

8 EU TONG SEN STREET #14-83 THE  
CENTRAL SINGAPORE(059818).

( 540 )



(511) 30

(210) No. 49109

(220) 16/10/2023

(732) CHUMAHANLA FOOD (PANZHOU) CO.,  
LTD

3F, Building 6, Xiaolan Industrial Park,  
Lianghe Street, Panzhou, Liupanshui City,  
Guizhou Province 561600, China.



( 540 )



(511) 42

(210) No. 49110

(220) 16/10/2023

(732) Shanghai Sheng Jun Information Technology  
Ltd.

58 Bu Zhen Nan Rd., Bu Zhen, Chong Ming  
Dist., Shanghai, China.

( 540 )



(511) 09

(210) No. 49111

(220) 16/10/2023

(732) Beijing Jingheng Tengwei Kejian Trade Co.,  
Ltd.

Room 306, Third Floor, 28-09 Nanhuan  
Road, Chengbei Street, Changping District,  
Beijing, China.

( 540 )

**NORD**

(511) 09

(210) No. 49112

(220) 16/10/2023

(732) Beijing Fenggu Commercial and Trading  
Co., Ltd.

West Area, 4th Floor, No.11 Zhushikou  
Street, Dongcheng District, Beijing, China.

( 540 )

**NORD**

(511) 38

(210) No. 49113

(220) 16/10/2023

(732) Beijing Fenggu Commercial and Trading  
Co., Ltd.

West Area, 4th Floor, No.11 Zhushikou  
Street, Dongcheng District, Beijing, China.

( 540 )

**NORD**

(511) 42

(210) No. 49114

(220) 16/10/2023

(732) Beijing Fenggu Commercial and Trading  
Co., Ltd.

West Area, 4th Floor, No.11 Zhushikou

Street, Dongcheng District, Beijing, China.

( 540 )



(511) 35

(210) No. 49118

(220) 17/10/2023

(732) Rong Thai International Group Co., Ltd.

88 Moo 8, Rong Thai Tower Tambol

Krathum Lom, Amphur Samphran, Nakhon

Pathom 73220, Thailand.

( 540 )

The logo for BJOJI, featuring the letters 'BJOJI' in a bold, italicized, sans-serif font. The letters are black and have a slight shadow effect.

(511) 35

(210) No. 49119

(220) 17/10/2023

(732) Rong Thai International Group Co., Ltd.

88 Moo 8, Rong Thai Tower Tambol

Krathum Lom, Amphur Samphran, Nakhon

Pathom 73220, Thailand.

( 540 )

Kris Bella

(511) 18

(210) No. 49122

(220) 18/10/2023

(732) Cai Yan

Room 1602, Block 7, District 2, No. 38,

Foshan Avenue North, Chancheng District,

Foshan City, Guangdong Province, China.

( 540 )

**HAOHUA**

(511) 12

(210) No. 49123

(220) 18/10/2023

(732) SHANDONG HAOHUA TIRE CO., LTD.

Dadi Road West, Xinhai Road North,  
Houzhen Industry Zone, Shouguang City,  
Weifang City, Shandong Province, China.

( 540 )

**Hiya**

(511) 05

(210) No. 49124

(220) 18/10/2023

(732) QUANZHOU XINGYUAN SUPPLY

CHAIN MANAGEMENT  
NO.19, QUANYUAN ROAD, ECONOMIC  
DEVELOPMENT ZOIYE (WULI PARK),  
JINJIANG CITY, QUANZHOU CITY,  
FUJIAN PROVINCE, 362000, CHINA.

( 540 )



(511) 35

(210) No. 49126

(220) 19/10/2023

(732) ບໍລິສັດ ເຄເອັມແອວ ການຄ້າ ຈຳກັດຜູ້ດຽວ

ບ້ານ ຫາດຊາຍຂາວ, ເມືອງ ຫາດຊາຍຝອງ,

ນະຄອນຫຼວງວຽງຈັນ, ສປປ ລາວ

( 540 )

**CARNIVAL**

(511) 25

(210) No. 49127

(220) 19/10/2023

(732) Carnival Supply Co., Ltd.

88, 5th Floor, Room No. E503, 504, Active  
Box Building (Stadium One Sport Complex),  
Soi Chulalongkorn 5, Rama 6 Road,  
Wangmai, Pathumwan, Bangkok, 10330,  
Thailand.

( 540 )

**CARNIVAL**

(511) 26

(210) No. 49128

(220) 19/10/2023

(732) Carnival Supply Co., Ltd.

88, 5th Floor, Room No. E503, 504, Active  
Box Building (Stadium One Sport Complex),  
Soi Chulalongkorn 5, Rama 6 Road,  
Wangmai, Pathumwan, Bangkok, 10330,  
Thailand.

( 540 )

**CARNIVAL**

(511) 35

(210) No. 49129

(220) 19/10/2023

(732) Carnival Supply Co., Ltd.

88, 5th Floor, Room No. E503, 504, Active  
Box Building (Stadium One Sport Complex),  
Soi Chulalongkorn 5, Rama 6 Road,  
Wangmai, Pathumwan, Bangkok, 10330,  
Thailand.

( 540 )

**HUNMUI**

(511) 09

(210) No. 49130

(220) 20/10/2023

(732) ELE (GROUP) CO., LTD.

Room 507A, No.519 Shenchang Road,

Minhang District, Shanghai 201107, China.

( 540 )

**BO LIAN**

(511) 35

(210) No. 49131

(220) 20/10/2023

(732) MR CAI QINGFENG

ບ້ານ ວັດໂຕ້ນ້ອຍທົ່ງ, ເມືອງ ສີໂຄດຕະບອງ,

ນະຄອນຫຼວງວຽງຈັນ, ສປປ ລາວ



( 540 )

**HUNMUI**

(511) 03

(210) No. 49132

(220) 20/10/2023

(732) Guangzhou Kaimandi Trading Co., Ltd.  
Room 604-1, Ronghai International Business  
Center, No. 585, Helong 1st Road, Helong  
Street, Baiyun District, Guangzhou City,  
Guangdong Province 510000, China.

( 540 )

**GUGKDD**  
always new

(511) 11

(210) No. 49133

(220) 20/10/2023

(732) Jionghui Chen  
No. 1, Shiyi Hengxiang, Xinfeng Middle  
Road, Chengbei Street, Lianjiang City,  
Guangdong Province, China.

( 540 )



(511) 30

(210) No. 49134

(220) 20/10/2023

(732) MIHAMEX JOINT STOCK COMPANY

Phu Minh Industrial Park, Co Nhue 2 Ward,  
Bac Tu Liem District, Hanoi City, Vietnam.

( 540 )



(511) 07, 09 and 11

(210) No. 49135

(220) 20/10/2023

(732) ITEL TECHNOLOGY LIMITED

Flat N, 16/F, Block B, Universal Industrial  
Centre, 19-25 Shan Mei Street, Fotan, NT,  
Hong Kong, China.

( 540 )



(511) 32

(210) No. 49136

(220) 23/10/2023

(732) ນາງ ມ່ອງ ບົວຄຳດີ

ບ້ານ ໂພນທັນ ເມືອງໄຊເສດຖາ ນະຄອນຫຼວງວຽງຈັນ,  
ສປປ ລາວ

( 540 )



(511) 01

(210) No. 49137

(220) 23/10/2023

(732) ທ່ານ ນາງ ເຂັມຄຳ ລັດທິດາ

ບ້ານ ດົງສະຫວາດ, ເມືອງ ສີສັດຕະນາກ,  
ນະຄອນຫຼວງວຽງຈັນ, ສປປ ລາວ

( 540 )



(511) 16

(210) No. 49138

(220) 23/10/2023

(732) ນາງ ມາລາວິງ ມະນີແສງ

ບ້ານ ນາສາລາ, ເມືອງ ໄຊທານີ, ນະຄອນຫຼວງວຽງຈັນ,  
ສປປ ລາວ

( 540 )

**VONE LAO**

(511) 25

(210) No. 49139

(220) 23/10/2023

(732) ນາງ ດາວອອນ ໄຊຍະບຸນຊຸ

ບ້ານ ພະໂພ, ເມືອງ ສີສັດຕະນາກ, ນະຄອນຫຼວງວຽງຈັນ,  
ສປປ ລາວ

( 540 )



(511) 30

(210) No. 49140

(220) 23/10/2023

(732) ໂຮງງານ ຜະລິດນໍ້າມັນໝາກຜ້າວ ສະກັດເຢັນ ວິລະວິງ

ສ່ວນບຸກຄົນ

ບ້ານ ທ່ານາ, ເມືອງ ຫາດຊາຍຝອງ,

ນະຄອນຫຼວງວຽງຈັນ, ສປປ ລາວ

( 540 )



(511) 05

(210) No. 49141

(220) 23/10/2023

(732) ວິສາຫະກິດສ່ວນບຸກຄົນ ຫ້ອງປຸງແຕ່ງຢາພື້ນເມືອງ

ກາສິງທອງ

ບ້ານ ຊຽງດາ, ເມືອງ ໄຊເສດຖາ,

ນະຄອນຫຼວງວຽງຈັນ, ສປປ ລາວ

( 540 )



(511) 05

(210) No. 49142

(220) 23/10/2023

(732) ວິສາຫະກິດສ່ວນບຸກຄົນ ຫ້ອງປຸງແຕ່ງຢາພື້ນເມືອງ

ກາເສືອ 1 ໂຕ

ບ້ານ ໜອງດ້ວງທົ່ງ, ເມືອງສີໂຄດຕະບອງ,

ນະຄອນຫຼວງວຽງຈັນ, ສປປ ລາວ

( 540 )



(511) 30

(210) No. 49143

(220) 23/10/2023

(732) ຍອດຊຳ ສ່ວນບຸກຄົນ

ບ້ານ ກາງ, ເມືອງ ຊຳເໜືອ, ແຂວງ ຫົວພັນ,

ສປປ ລາວ

( 540 )



(511) 05

(210) No. 49144

(220) 23/10/2023

(732) ວິສາຫະກິດສ່ວນບຸກຄົນ ໂຮງງານ ຢາກາມັງກອນ

ບ້ານ ວຽງສະຫວັນ ເມືອງ ສີໂຄດຕະບອງ

ນະຄອນຫຼວງວຽງຈັນ, ສປປ ລາວ

( 540 )



(511) 30

(210) No. 49145

(220) 23/10/2023

(732) ນາງ ວັນມະນີ ຈັນງາຄຳ

ບ້ານ ໜ່ອງໜຽງ, ເມືອງໄຊທານີ,

ນະຄອນຫຼວງວຽງຈັນ, ສປປ ລາວ

( 540 )

**MIKIREI**

(511) 16

(210) No. 49146

(220) 23/10/2023

(732) LIHONG HE

No. 152, Mixi Village, Suxi Town, Yiwu

City, Jinhua City, Zhejiang Province, China.

( 540 )



(511) 05

(210) No. 49147

(220) 23/10/2023

(732) ບໍລິສັດ ບົວຫິມະພື້ນເມືອງ ການຄ້າ ຈຳກັດຜູ້ດຽວ

ບ້ານ ໜອງໄຮ, ເມືອງ ຫາດຊາຍຝອງ,

ນະຄອນຫຼວງວຽງຈັນ, ສປປ ລາວ



( 540 )



(511) 05

(210) No. 49148

(220) 23/10/2023

(732) ບໍລິສັດ ບົວຫິມະພິນເມືອງ ການຄ້າ ຈຳກັດຜູ້ດຽວ

ບ້ານ ໜອງໄຮ, ເມືອງ ຫາດຊາຍຝອງ,

ນະຄອນຫຼວງວຽງຈັນ, ສປປ ລາວ

( 540 )



(511) 29, 30 and 31

(210) No. 49149

(220) 24/10/2023

(732) ບໍລິສັດດວງດາວສະຫວັນ ຈຳກັດຜູ້ດຽວ

ບ້ານ ນາຫວາຍ, ເມືອງຫີນເຫີບ ແຂວງ ວຽງຈັນ,

ສປປ ລາວ

( 540 )



(511) 16

(210) No. 49154

(220) 24/10/2023

(732) YUNNAN XINGLIANG INDUSTRIAL  
CO.,LTD

No.55 Guanyinsi, Huangtupo Road, Western  
Suburb, Wuhua District, Kunming, Yunnan  
Province, China.

( 540 )



(511) 36

(210) No. 49155

(220) 25/10/2023

(732) ບໍລິສັດ ຮຸ່ງເຮືອງ ບໍລິຫານອະສັງຫາລິມະຊັບ

ຈໍາກັດຜູ້ດຽວ

ບ້ານ ໜອງບອນ, ເມືອງ ໄຊເສດຖາ,

ນະຄອນຫຼວງວຽງຈັນ, ສປປ ລາວ

( 540 )



(511) 35

(210) No. 49156

(220) 25/10/2023

(732) ບໍລິສັດ ກ້ອກ ກ້ອກ ແອວລ໌ ຈຳກັດຜູ້ດຽວ

ບ້ານ ໜອງບອນ, ເມືອງ ໄຊເສດຖາ,

ນະຄອນຫຼວງວຽງຈັນ, ສປປ ລາວ

( 540 )



(511) 36

(210) No. 49157

(220) 25/10/2023

(732) ບໍລິສັດ ຖືຮຸ້ນ ລ້ານຊ້າງ ຈຳກັດຜູ້ດຽວ

ບ້ານ ໜອງບອນ, ເມືອງ ໄຊເສດຖາ,

ນະຄອນຫຼວງວຽງຈັນ, ສປປ ລາວ

( 540 )



(511) 39

(210) No. 49158

(220) 25/10/2023

(732) ບໍລິສັດ ລາວ ສະມາດ ໂມບິລິຕີ ຈຳກັດ

ບ້ານ ໜອງບອນ, ເມືອງ ໄຊເສດຖາ,

ນະຄອນຫຼວງວຽງຈັນ, ສປປ ລາວ

( 540 )



(511) 37

(210) No. 49159

(220) 25/10/2023

(732) ບໍລິສັດ ຮິດຈໍຣີສອດສ໌ ຈຳກັດ

ບ້ານ ໜອງບອນ, ເມືອງ ໄຊເສດຖາ,

ນະຄອນຫຼວງວຽງຈັນ, ສປປ ລາວ

( 540 )



(511) 37

(210) No. 49160

(220) 25/10/2023

(732) ບໍລິສັດ ແຮ່ທາດລາວ ຈຳກັດ

ບ້ານ ໜອງບອນ, ເມືອງ ໄຊເສດຖາ,

ນະຄອນຫຼວງວຽງຈັນ, ສປປ ລາວ

( 540 )

**AIFEN**

(511) 09

(210) No. 49161

(220) 25/10/2023

(732) Foshan Cengon Electronic Intelligent

Equipment Co., Ltd

Rm. 502, Bldg. 4 Shunde Wanyang Crowd

Innovation Park, 8-1 West Area 1st Rd.,

Xiantang Vil., Longjiang Town, Shunde Dist.,

Foshan City, Guangdong Province, China.

( 540 )

**AIFEN**

(511) 11

(210) No. 49162

(220) 25/10/2023

(732) Foshan Cengon Electronic Intelligent

Equipment Co., Ltd

Rm. 502, Bldg. 4 Shunde Wanyang Crowd

Innovation Park,8-1 West Area 1st Rd.,

Xiantang Vil., Longjiang Town, Shunde

Dist., Foshan City , Guangdong Province,

China.

( 540 )

**SUGON**

(511) 09

(210) No. 49163

(220) 25/10/2023

(732) Foshan Cengon Electronic Intelligent

Equipment Co., Ltd

Rm. 502, Bldg. 4 Shunde Wanyang Crowd

Innovation Park,8-1 West Area 1st Rd.,

Xiantang Vil., Longjiang Town, Shunde

Dist., Foshan City , Guangdong Province,

China.

( 540 )

**SUGON**

(511) 11

(210) No. 49164

(220) 25/10/2023

(732) Foshan Cengon Electronic Intelligent

Equipment Co., Ltd

Rm. 502, Bldg. 4 Shunde Wanyang Crowd

Innovation Park,8-1 West Area 1st Rd.,

Xiantang Vil., Longjiang Town, Shunde

Dist., Foshan City, Guangdong Province,

China.

( 540 )



(511) 06 and 19

(210) No. 49168

(220) 25/10/2023

(732) ບໍລິສັດ ທໍ່ນໍ້າລາວ ອຸດສາຫະກໍາ ເທັກໂນໂລຢີ

ຈໍາກັດຜູ້ດຽວ

ບ້ານ ໜອງໜ່ວງ, ເມືອງ ໄຊທານີ,

ນະຄອນຫຼວງວຽງຈັນ, ສປປ ລາວ

( 540 )



(511) 06 and 19

(210) No. 49169

(220) 25/10/2023

(732) ບໍລິສັດ ທ່ນ້າລາວ ອຸດສາຫະກຳ ເທັກໂນໂລຢີ

ຈຳກັດຜູ້ດຽວ

ບ້ານ ໜອງໜຽງ, ເມືອງ ໄຊທານີ,

ນະຄອນຫຼວງວຽງຈັນ, ສປປ ລາວ

( 540 )

**LI'ER**

(511) 05

(210) No. 49170

(220) 25/10/2023

(732) LIER CHEMICAL CO., LTD.

Economic & Technical Development Zone of  
Mianyang City, Sichuan Province,  
P.R. China.



( 540 )

SH-RD

(511) 03

(210) No. 49174

(220) 26/10/2023

(732) SHAAN HONQ INT'L COSMETICS CORP.  
29F., No. 55, Zhongzheng 3rd Rd., Xinxing  
Dist., Kaohsiung City 800307, Taiwan  
(R.O.C.).

( 540 )

 利尔化学  
LIER-Chemical

(511) 05

(210) No. 49175

(220) 26/10/2023

(732) LIER CHEMICAL CO., LTD.  
Economic & Technical Development Zone of  
Mianyang City, Sichuan Province,  
P.R. China.

( 540 )



(511) 01

(210) No. 49176

(220) 26/10/2023

(732) GOLDEN CONCORD HOLDINGS  
LIMITED

Unit 1703B-1706, Level 17, International  
Commerce Centre, 1 Austin Road West,  
Kowloon, Hong Kong.

( 540 )



(511) 09

(210) No. 49177

(220) 26/10/2023

(732) GOLDEN CONCORD HOLDINGS  
LIMITED

unit 1703B-1706, Level 17, International  
commerce Centre, 1 Austin Road west,  
Kowloon, Hong Kong.

( 540 )

The logo for LINGLONG, featuring a stylized 'L' inside a circle followed by the word 'LINGLONG' in a bold, sans-serif font.

(511) 12

(210) No. 49178

(220) 26/10/2023

(732) SHANDONG LINGLONG TYRE CO., LTD.  
777, Jinlong Road, Zhaoyuan City, Shandong  
Province, China.

( 540 )

The logo for CHINA DUTY FREE GROUP CO., LTD., consisting of the lowercase letters 'cdf' in a bold, sans-serif font.

(511) 35

(210) No. 49179

(220) 26/10/2023

(732) CHINA DUTY FREE GROUP CO., LTD.  
Block A, Zhengdong International Building,  
No. 42, Dongzhimenwai Xiaojie, Dongcheng  
District, Beijing, China.

( 540 )



(511) 24

(210) No. 49180

(220) 26/10/2023

(732) ທ້າວ ເມສາ ສັງທອງວິດຈິດຣ໌

ບ້ານ ນາທິມ, ເມືອງ ໄຊທານີ, ນະຄອນຫຼວງວຽງຈັນ,  
ສປປ ລາວ

( 540 )



(511) 30

(210) No. 49181

(220) 26/10/2023

(732) ບໍລິສັດ ບີຊີ ໄບຊວນ ການຄ້າ ຂາອອກ-ຂາເຂົ້າ ຈຳກັດ

ບ້ານ ປາກທ້າງ, ເມືອງ ສີໂຄດຕະບອງ,  
ນະຄອນຫຼວງວຽງຈັນ, ສປປ ລາວ

( 540 )



(511) 24

(210) No. 49182

(220) 26/10/2023

(732) ຮ້ານ ກິນນາລີ ດີຊາຍ ສ່ວນບຸກຄົນ

ບ້ານ ວຽງຈະເລີນ, ເມືອງ ໄຊເສດຖາ,

ນະຄອນຫຼວງວຽງຈັນ, ສປປ ລາວ

( 540 )



(511) 43

(210) No. 49183

(220) 26/10/2023

(732) ວິສາຫະກິດ ສ່ວນບຸກຄົນ ຮ້ານ ປ້ຽງປ້ຽງ ໝາລ້າທ້າງ

ບ້ານ ໜອງດ້ວງໃຕ້, ເມືອງ ສີໂຄດຕະບອງ,

ນະຄອນຫຼວງວຽງຈັນ, ສປປ ລາວ

( 540 )



(511) 43

(210) No. 49184

(220) 26/10/2023

(732) ວິສາຫະກິດ ສ່ວນບຸກຄົນ ຮ້ານ ປ້ຽງປ້ຽງ ຫົວກົວ

ຮ່ອດຜ່ອດ

ບ້ານ ສີບຸນເຮືອງ, ເມືອງ ຈັນທະບູລີ,

ນະຄອນຫຼວງວຽງຈັນ, ສປປ ລາວ

( 540 )



(511) 01

(210) No. 49185

(220) 27/10/2023

(732) ບໍລິສັດ ກ້າວໜ້າ ການກະເສດ ແລະ ອຸດສາຫະກຳ

ການຄ້າ ຂາອອກ-ຂາເຂົ້າ ຈຳກັດ

ຖະໜົນ 13 ໄຕ້, ບ້ານ ບຶງຫົວນາ, ເມືອງເຊບັ້ງໄຟ,

ແຂວງ ຄຳມ່ວນ, ສປປ ລາວ

( 540 )

**NIMOKI**

(511) 12

(210) No. 49187

(220) 27/10/2023

(732) ບໍລິສັດ ເຄອິສະຕາ ນໍາເຂົ້າ ແລະ ສົ່ງອອກ ຈຳກັດຜູ້ດຽວ

ບ້ານ ທາດຫຼວງໃຕ້, ເມືອງ ໄຊເສດຖາ,

ນະຄອນຫຼວງວຽງຈັນ, ສປປ ລາວ

( 540 )

**SUPEKA**

(511) 12

(210) No. 49188

(220) 27/10/2023

(732) ບໍລິສັດ ເຄອິສະຕາ ນໍາເຂົ້າ ແລະ ສົ່ງອອກ ຈຳກັດຜູ້ດຽວ

ບ້ານ ທາດຫຼວງໃຕ້, ເມືອງ ໄຊເສດຖາ,

ນະຄອນຫຼວງວຽງຈັນ, ສປປ ລາວ

( 540 )

**KUBOKI**

(511) 12

(210) No. 49189

(220) 27/10/2023

(732) ບໍລິສັດ ເຄອິສະຕາ ນໍາເຂົ້າ ແລະ ສົ່ງອອກ ຈໍາກັດຜູ້ດຽວ

ບ້ານ ທາດຫຼວງໃຕ້, ເມືອງ ໄຊເສດຖາ,

ນະຄອນຫຼວງວຽງຈັນ, ສປປ ລາວ

( 540 )

**HANABI**

(511) 12

(210) No. 49190

(220) 27/10/2023

(732) ບໍລິສັດ ເຄອິສະຕາ ນໍາເຂົ້າ ແລະ ສົ່ງອອກ ຈໍາກັດຜູ້ດຽວ

ບ້ານ ທາດຫຼວງໃຕ້, ເມືອງ ໄຊເສດຖາ,

ນະຄອນຫຼວງວຽງຈັນ, ສປປ ລາວ



( 540 )

**HANADA**

(511) 12

(210) No. 49191

(220) 27/10/2023

(732) ບໍລິສັດ ເຄອິສະຕາ ນໍາເຂົ້າ ແລະ ສົ່ງອອກ ຈຳກັດຜູ້ດຽວ

ບ້ານ ທາດຫຼວງໃຕ້, ເມືອງ ໄຊເສດຖາ,

ນະຄອນຫຼວງວຽງຈັນ, ສປປ ລາວ

( 540 )

**KONABI**

(511) 12

(210) No. 49192

(220) 27/10/2023

(732) ບໍລິສັດ ເຄອິສະຕາ ນໍາເຂົ້າ ແລະ ສົ່ງອອກ ຈຳກັດຜູ້ດຽວ

ບ້ານ ທາດຫຼວງໃຕ້, ເມືອງ ໄຊເສດຖາ,

ນະຄອນຫຼວງວຽງຈັນ, ສປປ ລາວ

( 540 )

The logo for JSP consists of the letters 'JSP' in a bold, sans-serif font. A small, stylized leaf icon is positioned to the left of the letter 'J'.

(511) 40

(210) No. 49193

(220) 27/10/2023

(732) JSP PHARMACEUTICAL

MANUFACTURING (THAILAID)

PUBLIC COMPANY LIMITED

255, 257 Soi. Sathopradit 58, Bangpongpan,  
Yannawa, Bangkok, Thailand.

( 540 )

The logo for Tribox consists of the word 'Tribox' in a bold, sans-serif font.

(511) 34

(210) No. 49194

(220) 27/10/2023

(732) Shenzhen Kanger Technology Co., Ltd

2/F, Factory building A3, Tongwei

Optoelectronics Factory, No. 8 Gongye 2nd

Road, Shilong Community, Shiyan Street,

Bao'an District, Shenzhen City, Guangdong

Province, China.

( 540 )



(511) 07

(210) No. 49195

(220) 27/10/2023

(732) Zhejiang Yuebei Fan Electromechanical Co.,  
Ltd  
No.6 Fangyan Road, Daxi Town, Wenling  
City, Taizhou City, Zhejiang Province, China.

( 540 )



(511) 05

(210) No. 49196

(220) 30/10/2023

(732) JSP PHARMACEUTICAL  
MANUFACTURING (THAILAID)  
PUBLIC COMPANY LIMITED  
255, 257 Soi. Sathopradit 58, Bangpongpan,  
Yannawa, Bangkok, Thailand.

( 540 )



(511) 30

(210) No. 49431

(220) 07/12/2023

(732) ນາງ ຂັນທະລີ ເດດວິງຜັນ

ບ້ານ ໂນນສະຫວ່າງ, ເມືອງ ວຽງຄໍາ, ແຂວງ ວຽງຈັນ,  
ສປປ ລາວ

## ພາກທີ III

### (Part III)

## ເຄື່ອງໝາຍການຄ້າ

### Trademarks

## 2. ຜົນການຈົດທະບຽນ

### (Registration)

#### ຄໍາອະທິບາຍກ່ຽວກັບລະຫັດຫຍໍ້

#### (Introduction of Codes)

- (540) ເຄື່ອງໝາຍການຄ້າ (Trademark)
- (511) ໝວດ (Nice Classification)
- (210) ເລກທີ ຄໍາຮ້ອງ (Number of the application)
- (220) ວັນທີ ຄໍາຮ້ອງ (Date of filing of the application)
- (732) ຊື່ ແລະ ທີ່ຢູ່ ຂອງຜູ້ຍື່ນຄໍາຮ້ອງ (Name and Address of applicant)
- (111) ເລກທີ ການຈົດທະບຽນເຄື່ອງໝາຍການຄ້າ (Number of the registration)
- (180) ວັນໝົດອາຍຸຂອງການຈົດທະບຽນ (Expiration date of the registration)

( 540 )



(511) 30

(210) No. 44381

(220) 11/03/2020

(732) ນາງ ຄໍາລີ້ ພິລາວິງ

ບ້ານຊຽງຍືນ ເມືອງ ຈັນທະບູລີ ນະຄອນຫຼວງວຽງຈັນ,

ສປປ ລາວ

(111) No. 59544

(180) 11/03/2030

( 540 )



(511) 25, 28 and 35

(210) No. 47610

(220) 03/11/2022

(732) ບໍລິສັດ ອີໂວ ຈໍາກັດ

ບ້ານ ຄໍາຮຸ່ງ, ເມືອງ ໄຊທານີ, ນະຄອນຫຼວງວຽງຈັນ,

ສປປ ລາວ

(111) No. 59545

(180) 03/11/2032

( 540 )



(511) 09

(210) No. 48701

(220) 19/07/2023

(732) TRAN PHU ELECTRIC MECHANICAL  
JOINT STOCK COMPANY

No. 41 Phuong Liet Street, Phuong Liet

Ward, Thanh Xuan District - Hanoi, Vietnam

(111) No. 59546

(180) 19/07/2033

( 540 )

**A K E M I**

(511) 03 and 35

(210) No. 48702

(220) 21/07/2023

(732) Eastern Decorator Sdn Bhd

Lot 55992, Batu 5, Off Jalan Tunku Abdul

Rahman, 31200 Ipoh, Perak, Malaysia

(111) No. 59547

(180) 21/07/2033

( 540 )

**Avanti**

(511) 20

(210) No. 48703

(220) 21/07/2023

(732) Eastern Decorator Sdn Bhd

Lot 55992, Batu 5, Off Jalan Tunku Abdul  
Rahman, 31200 Ipoh, Perak, Malaysia

(111) No. 59548

(180) 21/07/2033

( 540 )

**AimEco**

(511) 20

(210) No. 48704

(220) 21/07/2023

(732) Eastern Decorator Sdn Bhd

Lot 55992, Batu 5, Off Jalan Tunku Abdul  
Rahman, 31200 Ipoh, Perak, Malaysia

(111) No. 59549

(180) 21/07/2033



( 540 )

MITESGARD

(511) 20 and 24

(210) No. 48705

(220) 21/07/2023

(732) Eastern Decorator Sdn Bhd

Lot 55992, Batu 5, Off Jalan Tunku Abdul  
Rahman, 31200 Ipoh, Perak, Malaysia.

(111) No. 59550

(180) 21/07/2033

( 540 )

WINNY

(511) 24

(210) No. 48706

(220) 21/07/2023

(732) Eastern Decorator Sdn Bhd

Lot 55992, Batu 5, Off Jalan Tunku Abdul  
Rahman, 31200 Ipoh, Perak, Malaysia

(111) No. 59551

(180) 21/07/2033

( 540 )



(511) 35

(210) No. 48707

(220) 21/07/2023

(732) ບໍລິສັດ ອີ້ຫຼຽນການຄ້າ ຂາເຂົ້າຂາອອກ ຈຳກັດຜູ້ດຽວ

ບ້ານ ຂົວຫຼວງເໜືອ, ເມືອງຈັນທະບູລີ,

ນະຄອນຫຼວງວຽງຈັນ, ສປປ ລາວ

(111) No. 59552

(180) 21/07/2033

( 540 )



(511) 30

(210) No. 48708

(220) 21/07/2023

(732) ໂຮງງານປຸງແຕ່ງຊາ ສີມຈັນບຸນ ໄຊຍະວິງ ຈຳກັດຜູ້ດຽວ

ບ້ານມົງເຈົ້າ, ເມືອງຜົ້ງສາລີ, ແຂວງຜົ້ງສາລີ, ສປປ ລາວ

(111) No. 59553

(180) 21/07/2033

( 540 )



(511) 32

(210) No. 48710

(220) 21/07/2023

(732) Fraser and Neave, Limited

438 Alexandra Road, #20-00 Alexandra  
Point, Singapore 119958

(111) No. 59555

(180) 21/07/2033

( 540 )

The logo for iQOO features the lowercase letters "iQOO" in a bold, black, sans-serif font. The "i" is smaller and positioned to the left of the "QOO".

(511) 18

(210) No. 48711

(220) 21/07/2023

(732) Vivo Mobile Communication Co., Ltd.

No.1, vivo Road, Chang'an, Dongguan,  
Guangdong, China

(111) No. 59556

(180) 21/07/2033

( 540 )

**iQOO**

(511) 25

(210) No. 48712

(220) 21/07/2023

(732) Vivo Mobile Communication Co., Ltd.  
No.1, vivo Road, Chang'an, Dongguan,  
Guangdong, China

(111) No. 59557

(180) 21/07/2033

( 540 )

**iQOO**

(511) 28

(210) No. 48713

(220) 21/07/2023

(732) Vivo Mobile Communication Co., Ltd,  
No.1, vivo Road, Chang'an, Dongguan,  
Guangdong, China

(111) No. 59558

(180) 21/07/2033

( 540 )



(511) 07 and 12  
(210) No. 48714  
(220) 21/07/2023  
(732) HANGZHOU UNIBEAR INDUSTRIAL  
CO., LTD.  
YIQIAO INDUSTRIAL PARK,  
XIAOSHAN, HANGZHOU, ZHEJIANG,  
CHINA  
(111) No. 59559  
(180) 21/07/2033

( 540 )



(511) 02  
(210) No. 48715  
(220) 21/07/2023  
(732) JORAKAY CORPORATION CO., LTD.  
10 Krungthepkreetha Road, Thapchang,  
Saphansung, Bangkok 10250, Thailand  
(111) No. 59560  
(180) 21/07/2033

( 540 )

**JORAKAY**

(511) 02

(210) No. 48716

(220) 21/07/2023

(732) JORAKAY CORPORATION CO., LTD.

10 Krungthepkreetha Road, Thapchang,  
Saphansung, Bangkok 10250, Thailand

(111) No. 59561

(180) 21/07/2033

( 540 )



(511) 35

(210) No. 48717

(220) 21/07/2023

(732) T.P. DRUG LABORATORIES (1969) CO.,  
LTD.

98 Soi Sukhumvit 62 Yak 1, Phra Khanong  
Tai Sub-district, Phra Khanong District,  
Bangkok 10260 Thailand

(111) No. 59562

(180) 21/07/2033

( 540 )

**MOBOMAKS**

(511) 05

(210) No. 48720

(220) 24/07/2023

(732) ບໍລິສັດ ອັກໂຊ ການຢາ ຈຳກັດ

ຖະໜົນ: ໂພນສະຫວ່າງ, ບ້ານ ໂພນສະຫວ່າງ, ເມືອງ

ຈັນທະບູລີ, ນະຄອນຫຼວງວຽງຈັນ, ສປປ ລາວ

(111) No. 59563

(180) 24/07/2033

( 540 )

**GILTEMAKS**

(511) 05

(210) No. 48721

(220) 24/07/2023

(732) ບໍລິສັດ ອັກໂຊ ການຢາ ຈຳກັດ

ຖະໜົນ: ໂພນສະຫວ່າງ, ບ້ານ ໂພນສະຫວ່າງ, ເມືອງ

ຈັນທະບູລີ, ນະຄອນຫຼວງວຽງຈັນ, ສປປ ລາວ

(111) No. 59564

(180) 24/07/2033

( 540 )

**CRIZOMAKS**

(511) 05

(210) No. 48722

(220) 24/07/2023

(732) ບໍລິສັດ ອັກໂຊ ການຢາ ຈຳກັດ

ຖະໜົນ: ໂພນສະຫວ່າງ, ບ້ານ ໂພນສະຫວ່າງ, ເມືອງ

ຈັນທະບູລີ, ນະຄອນຫຼວງວຽງຈັນ, ສປປ ລາວ

(111) No. 59565

(180) 24/07/2033

( 540 )

**CABOMAKS**

(511) 05

(210) No. 48723

(220) 24/07/2023

(732) ບໍລິສັດ ອັກໂຊ ການຢາ ຈຳກັດ

ຖະໜົນ: ໂພນສະຫວ່າງ, ບ້ານ ໂພນສະຫວ່າງ, ເມືອງ

ຈັນທະບູລີ, ນະຄອນຫຼວງວຽງຈັນ, ສປປ ລາວ

(111) No. 59566

(180) 24/07/2033



( 540 )

SOTORMAKS

(511) 05

(210) No. 48724

(220) 24/07/2023

(732) ບໍລິສັດ ອັກໂຊ ການຢາ ຈຳກັດ

ຖະໜົນ: ໂພນສະຫວ່າງ, ບ້ານ ໂພນສະຫວ່າງ, ເມືອງ

ຈັນທະບູລີ, ນະຄອນຫຼວງວຽງຈັນ, ສປປ ລາວ

(111) No. 59567

(180) 24/07/2033

( 540 )

LENMAKS

(511) 05

(210) No. 48725

(220) 24/07/2023

(732) ບໍລິສັດ ອັກໂຊ ການຢາ ຈຳກັດ

ຖະໜົນ: ໂພນສະຫວ່າງ, ບ້ານ ໂພນສະຫວ່າງ, ເມືອງ

ຈັນທະບູລີ, ນະຄອນຫຼວງວຽງຈັນ, ສປປ ລາວ

(111) No. 59568

(180) 24/07/2033

( 540 )

SELPMAKS

(511) 05

(210) No. 48726

(220) 24/07/2023

(732) ບໍລິສັດ ອັກໂຊ ການຢາ ຈຳກັດ

ຖະໜົນ: ໂພນສະຫວ່າງ, ບ້ານ ໂພນສະຫວ່າງ, ເມືອງ

ຈັນທະບູລີ, ນະຄອນຫຼວງວຽງຈັນ, ສປປ ລາວ

(111) No. 59569

(180) 24/07/2033

( 540 )

DABRAMAKS

(511) 05

(210) No. 48727

(220) 24/07/2023

(732) ບໍລິສັດ ອັກໂຊ ການຢາ ຈຳກັດ

ຖະໜົນ: ໂພນສະຫວ່າງ, ບ້ານ ໂພນສະຫວ່າງ, ເມືອງ

ຈັນທະບູລີ, ນະຄອນຫຼວງວຽງຈັນ, ສປປ ລາວ

(111) No. 59570

(180) 24/07/2033

( 540 )

TRAMAKS

(511) 05

(210) No. 48728

(220) 24/07/2023

(732) ບໍລິສັດ ອັກໂຊ ການຢາ ຈຳກັດ

ຖະໜົນ: ໂພນສະຫວ່າງ, ບ້ານ ໂພນສະຫວ່າງ, ເມືອງ

ຈັນທະບູລີ, ນະຄອນຫຼວງວຽງຈັນ, ສປປ ລາວ

(111) No. 59571

(180) 24/07/2033

( 540 )

OSIMAKS

(511) 05

(210) No. 48729

(220) 24/07/2023

(732) ບໍລິສັດ ອັກໂຊ ການຢາ ຈຳກັດ

ຖະໜົນ: ໂພນສະຫວ່າງ, ບ້ານ ໂພນສະຫວ່າງ, ເມືອງ

ຈັນທະບູລີ, ນະຄອນຫຼວງວຽງຈັນ, ສປປ ລາວ

(111) No. 59572

(180) 24/07/2033

( 540 )

LORLAMAKS

(511) 05

(210) No. 48730

(220) 24/07/2023

(732) ບໍລິສັດ ອັກໂຊ ການຢາ ຈຳກັດ

ຖະໜົນ: ໂພນສະຫວ່າງ, ບ້ານ ໂພນສະຫວ່າງ, ເມືອງ

ຈັນທະບູລີ, ນະຄອນຫຼວງວຽງຈັນ, ສປປ ລາວ

(111) No. 59573

(180) 24/07/2033

( 540 )

CAPMAKS

(511) 05

(210) No. 48731

(220) 24/07/2023

(732) ບໍລິສັດ ອັກໂຊ ການຢາ ຈຳກັດ

ຖະໜົນ: ໂພນສະຫວ່າງ, ບ້ານ ໂພນສະຫວ່າງ, ເມືອງ

ຈັນທະບູລີ, ນະຄອນຫຼວງວຽງຈັນ, ສປປ ລາວ

(111) No. 59574

(180) 24/07/2033

( 540 )



(511) 12

(210) No. 48732

(220) 24/07/2023

(732) ບໍລິສັດ ວຽງຈັນ ບາວຊິນ ການຄ້າ ຂາອອກ-ຂາເຂົ້າ  
ຈຳກັດຜູ້ດຽວ

ບ້ານ ນາຄຳ, ເມືອງ ສີໂຄດຕະບອງ,

ນະຄອນຫຼວງວຽງຈັນ, ສປປ ລາວ

(111) No. 59575

(180) 24/07/2033

( 540 )



(511) 29

(210) No. 48733

(220) 24/07/2023

(732) ບໍລິສັດ ສຸກຈະເລີນຝາມ ຈຳກັດຜູ້ດຽວ

ບ້ານ ໜິ້ນຫຼວງ, ເມືອງ ບາຈຽງ ຈະເລີນສຸກ, ແຂວງ

ຈຳປາສັກ, ສປປ ລາວ

(111) No. 59576

(180) 24/07/2033

( 540 )

**QSC**

(511) 09 and 42

(210) No. 48734

(220) 24/07/2023

(732) QSC, LLC

1675 MacArthur Blvd., Costa Mesa,  
California 92626, United States of America

(111) No. 59577

(180) 24/07/2033

( 540 )

**HALAY**

(511) 12

(210) No. 48735

(220) 24/07/2023

(732) ບໍລິສັດ ໂຮດາ ການຄ້າ ຈຳກັດ ຜູ້ດຽວ

ຖະໜົນ13 ເໜືອ ບ້ານ ໂພນໄຊ, ເມືອງໂພນໂຮງ,  
ແຂວງວຽງຈັນ, ນະຄອນຫຼວງວຽງຈັນ, ສປປ ລາວ

(111) No. 59578

(180) 24/07/2033

( 540 )



(511) 32

(210) No. 48736

(220) 25/07/2023

(732) PepsiCo, Inc.

700 Anderson Hill Road, Purchase, New  
York 10577, United States of America

(111) No. 59579

(180) 25/07/2033

( 540 )



(511) 32

(210) No. 48737

(220) 25/07/2023

(732) PepsiCo, Inc.

700 Anderson Hill Road, Purchase, New  
York 10577, United States of America

(111) No. 59580

(180) 25/07/2033

( 540 )



(511) 31

(210) No. 48738

(220) 25/07/2023

(732) SHANGHAI XUERONG  
BIOTECHNOLOGY CO., LTD.

No. 1487, Huifeng West Road, Fengxian  
District, Shanghai, China

(111) No. 59581

(180) 25/07/2033

( 540 )

DEEPAL

(511) 12

(210) No. 48739

(220) 25/07/2023

(732) CHONGQING CHANGAN AUTOMOBILE  
CO., LTD.

260 Jianxin East Road, Jiangbei District,  
Chongqing, China

(111) No. 59582

(180) 25/07/2033



( 540 )



(511) 12

(210) No. 48740

(220) 25/07/2023

(732) CHONGQING CHANGAN AUTOMOBILE  
CO., LTD.

260 Jianxin East Road, jiangbei District,  
Chongqing, China

(111) No. 59583

(180) 25/07/2033

( 540 )



(511) 01 and 19

(210) No. 48741

(220) 25/07/2023

(732) JORAKAY CORPORATION CO., LTD.

10 KRUNGTHEPKREETHA ROAD,  
THAPCHANG, SAPHANSUNG,  
BANGKOK 10250, THAILAND

(111) No. 59584

(180) 25/07/2033

( 540 )

**JORAKAY**



(511) 01 and 19

(210) No. 48742

(220) 25/07/2023

(732) JORAKAY CORPORATION CO., LTD.

10 KRUNGTHEPKREETHA ROAD,

THAPCHANG, SAPHANSUNG,

BANGKOK 10250, THAILAND

(111) No. 59585

(180) 25/07/2033

( 540 )

**JORAKAY**  
EASY 

(511) 01 and 19

(210) No. 48743

(220) 25/07/2023

(732) JORAKAY CORPORATION CO., LTD.

10 KRUNGTHEPKREETHA ROAD,

THAPCHANG, SAPHANSUNG,

BANGKOK 10250, THAILAND

(111) No. 59586

(180) 25/07/2033

( 540 )

**JORAKAY**

(511) 01 and 19

(210) No. 48744

(220) 25/07/2023

(732) JORAKAY CORPORATION CO., LTD.

10 KRUNGTHEPKREETHA ROAD,

THAPCHANG, SAPHANSUNG,

BANGKOK 10250, THAILAND

(111) No. 59587

(180) 25/07/2033

( 540 )



(511) 42

(210) No. 48745

(220) 25/07/2023

(732) ທ້າວ ວັນນະລິດ ໄຊຍະລາດ

ບ້ານ ຫ້ວຍຫົງ, ໜ່ວຍ 89 ເຮືອນເລກທີ 1364/4,

ເມືອງຈັນທະບູລີ, ນະຄອນຫລວງວຽງຈັນ, ສປປ ລາວ

(111) No. 59588

(180) 25/07/2033

( 540 )

The logo for MYMOL is displayed in a stylized, outlined font.

(511) 05

(210) No. 48746

(220) 25/07/2023

(732) BURAPHA DISPENSARY CO., LTD.

20 Soi Ngamwongwan 6 Yaek 3,

Ngamwongwan Road, Bangkhen, Muang,

Nonthaburi 11000, Thailand

(111) No. 59589

(180) 25/07/2033

( 540 )

The logo for ANS TECHNOLOGY features three colored circles (red, blue, yellow) to the left of the text 'ANS TECHNOLOGY' in a bold, blue font.

(511) 42

(210) No. 48748

(220) 27/07/2023

(732) ANS Technology

ເຮືອນເລກທີ 168, ຖະໜົນ ໄກສອນ ພິມວິຫານ,

ໜ່ວຍ01, ບ້ານ ໂພນໄຊ, ເມືອງ ໄຊເສດຖາ,

ນະຄອນຫຼວງວຽງຈັນ, ສປປ ລາວ

(111) No. 59590

(180) 27/07/2033

( 540 )



(511) 39

(210) No. 48749

(220) 27/07/2023

(732) ບໍລິສັດ ໂລຈິສຕິກ ຈຳກັດ

ເຮືອນເລກທີ 168, ຖະໜົນ ໄກສອນ ພິມວິຫານ,

ໜ່ວຍ 01, ບ້ານໂພນໄຊ, ເມືອງ ໄຊເສດຖາ,

ນະຄອນຫຼວງວຽງຈັນ, ສປປ ລາວ

(111) No. 59591

(180) 27/07/2033

( 540 )



(511) 12

(210) No. 48752

(220) 28/07/2023

(732) ບໍລິສັດເຄຕິພີ ການຄ້າຂາອອກ-ຂາເຂົ້າ ຈຳກັດຜູ້ດຽວ

ບ້ານ ຫ້ວຍນ້ຳເຢັນ ເມືອງ ນາຊາຍທອງ

ນະຄອນຫຼວງວຽງຈັນ, ສປປ ລາວ

(111) No. 59592

(180) 28/07/2033

( 540 )

**ARI**

(511) 34

(210) No. 48754

(220) 28/07/2023

(732) HONG THING GROUP CO., LTD

Building #33, Street 598, Phum Toul Porper,  
Sangkat Toul Sangker 2, Khan Russei Keo,  
Phnom Penh, Cambodia

(111) No. 59593

(180) 28/07/2033

( 540 )

**MECOLZINE**

(511) 05

(210) No. 48755

(220) 31/07/2023

(732) FAES FARMA, S.A.

Avenida Autonomia No. 10 - 48940 Lamiaco  
- Leioa (Bizkaia), Spain

(111) No. 59594

(180) 31/07/2033

( 540 )



(511) 30

(210) No. 48756

(220) 31/07/2023

(732) ວິສາຫະກິດສ່ວນບຸກຄົນ ບົວພອນ ຮັບຊື່ ແລະ

ຈໍາໜ່າຍນໍ້າເຜີ້ງ, ຜະລິດຕະພັນນໍ້າເຜີ້ງແສນລາດ

ບ້ານ ຫ້ວຍຍາງ, ເມືອງຂວາ, ແຂວງຜົ້ງສາລີ, ສປປ ລາວ

(111) No. 59595

(180) 31/07/2033

( 540 )



(511) 29, 30, 32, 35 and 43

(210) No. 48757

(220) 31/07/2023

(732) Shanghai Zhenjing Industrial Co., Ltd.

Room 124, Floor 1, No. 28, Shenpujing

Road, Zhujing Town, Jinshan District,

Shanghai, China

(111) No. 59596

(180) 31/07/2033

( 540 )

U6

(511) 12

(210) No. 48758

(220) 31/07/2023

(732) BYD COMPA.NY LIMITED

No.1, Yan'an Road, Kuichong Street Dapeng  
New District Shenzhen, China

(111) No. 59597

(180) 31/07/2033

( 540 )

U7

(511) 12

(210) No. 48759

(220) 31/07/2023

(732) BYD COMPA|IY LIMITED

No.1, Yan'an Road, Kuichong Street Dapeng  
New District Shenzhen, China

(111) No. 59598

(180) 31/07/2033



( 540 )

U8

(511) 12

(210) No. 48760

(220) 31/07/2023

(732) BYD COMPANY LIMITED

No.1, Yan'an Road, Kuichong Street Dapeng  
New District Shenzhen, China

(111) No. 59599

(180) 31/07/2033

( 540 )

U9

(511) 12

(210) No. 48761

(220) 31/07/2023

(732) BYD COMPANY LIMITED

No.1, Yan'an Road, Kuichong Street Dapeng  
New District, Shenzhen, China

(111) No. 59600

(180) 31/07/2033

## ພາກທີ III

### (Part III)

## ເຄື່ອງໝາຍການຄ້າ

### Trademarks

### 3. ການຕໍ່ອາຍ

#### (Renewal)

#### ຄຳອະທິບາຍກ່ຽວກັບລະຫັດຫຍໍ້

#### (Introduction of Codes)

- (540) ເຄື່ອງໝາຍການຄ້າ (Trademark)
- (511) ໝວດ (Nice Classification)
- (210) ເລກທີ ຄຳຮ້ອງ (Number of the application)
- (220) ວັນທີ ຄຳຮ້ອງ (Date of filing of the application)
- (732) ຊື່ ແລະ ທີ່ຢູ່ ຂອງຜູ້ຍື່ນຄຳຮ້ອງ (Name and Address of applicant)
- (111) ເລກທີການຈັດທະບຽນເຄື່ອງໝາຍການຄ້າ (Number of the registration)
- (180) ການຕໍ່ອາຍການຈັດທະບຽນ (Expiration date of the renewal)

( 540 ) Renewal

**3M**

(511) 01, 03, 05, 09, 10, 16, 17 and 21

(210) No. 2026

(220) 05/04/1993

(732) 3M Company

3M Center, 2501 Hudson Road, St. Paul

Minnesota 55144, United States of America

(111) No. 1873

(180) 05/04/2103

( 540 ) Renewal

**3M**

(511) 01, 03, 05, 09, 10, 16, 17 and 21

(210) No. 2026

(220) 05/04/1993

(732) 3M Company

3M Center, 2501 Hudson Road, St. Paul

Minnesota 55144, United States of America

(111) No. 1873

(180) 05/04/2093

( 540 ) Renewal

**3M**

(511) 01, 03, 05, 09, 10, 16, 17 and 21

(210) No. 2026

(220) 05/04/1993

(732) 3M Company

3M Center, 2501 Hudson Road, St. Paul

Minnesota 55144, United States of America

(111) No. 1873

(180) 05/04/2083

( 540 ) Renewal

**3M**

(511) 01, 03, 05, 09, 10, 16, 17 and 21

(210) No. 2026

(220) 05/04/1993

(732) 3M Company

3M Center, 2501 Hudson Road, St. Paul

Minnesota 55144, United States of America

(111) No. 1873

(180) 05/04/2073

( 540 ) Renewal

**3M**

(511) 01, 03, 05, 09, 10, 16, 17 and 21

(210) No. 2026

(220) 05/04/1993

(732) 3M Company

3M Center, 2501 Hudson Road, St. Paul

Minnesota 55144, United States of America

(111) No. 1873

(180) 05/04/2033

( 540 ) Renewal

**3M**

(511) 01, 03, 05, 09, 10, 16, 17 and 21

(210) No. 2026

(220) 05/04/1993

(732) 3M Company

3M Center, 2501 Hudson Road, St. Paul

Minnesota 55144, United States of America

(111) No. 1873

(180) 05/04/2063

( 540 ) Renewal

**3M**

(511) 01, 03, 05, 09, 10, 16, 17 and 21

(210) No. 2026

(220) 05/04/1993

(732) 3M Company

3M Center, 2501 Hudson Road, St. Paul

Minnesota 55144, United States of America

(111) No. 1873

(180) 05/04/2053

( 540 ) Renewal

**3M**

(511) 01, 03, 05, 09, 10, 16, 17 and 21

(210) No. 2026

(220) 05/04/1993

(732) 3M Company

3M Center, 2501 Hudson Road, St. Paul

Minnesota 55144, United States of America

(111) No. 1873

(180) 05/04/2043

( 540 ) Renewal

**BASKIN-ROBBINS**

(511) 29, 30, 32, 35, 41 and 43

(210) No. 2304

(220) 21/07/1993

(732) BR IP HOLDER LLC

130 Royall Street, Canton, Massachusetts  
02021, United States of America

(111) No. 2165

(180) 21/07/2033

( 540 ) Renewal



(511) 07 and 12

(210) No. 2312

(220) 21/07/1993

(732) CUMMINS INC.,

500 Jackson Steet, Columbus, Indiana,  
United States of America

(111) No. 2173

(180) 21/07/2033

( 540 ) Renewal



(511) 07 and 12

(210) No. 2312

(220) 21/07/1993

(732) CUMMINS INC.,

500 Jackson Steet, Columbus, Indiana,  
United States of America

(111) No. 2173

(180) 21/07/2043

( 540 ) Renewal

**RIKEN**

(511) 06 and 11

(210) No. 2346

(220) 03/08/1993

(732) KABUSHIKI KAISHA RIKEN

8-1, Sanbancho, Chiyoda-ku, Tokyo,  
Japan

(111) No. 2204

(180) 03/08/2043



( 540 ) Renewal



(511) 26

(210) No. 2360

(220) 18/08/1993

(732) ORGAN NEEDLE CO., LTD.

No., 1, Oaza Maeyama, Ueda-shi, Nagano-  
ken, Japan

(111) No. 2210

(180) 18/08/2033

( 540 ) Renewal

**CLEARASIL**

(511) 03

(210) No. 2366

(220) 27/08/1993

(732) RECKITT BENCKISER DEUTSCHLAND

GMBH

Theodor-Heuss-Anlage 12, 68165 Mannheim,  
Germany

(111) No. 2214

(180) 27/08/2033

( 540 ) Renewal

**SOFITEL**

(511) 42

(210) No. 2519

(220) 28/09/1993

(732) SOLUXURY HMC

82 rue Henri Farman, 92130 Issy-les-  
Moulineaux, France

(111) No. 2260

(180) 28/09/2033

( 540 ) Renewal

**TIMKEN**

(511) 12

(210) No. 2561

(220) 14/10/1993

(732) The Timken Company

4500 Mount Pleasant Street NW, North  
Canton, Ohio 44720, United States of America

(111) No. 2402

(180) 14/10/2013

( 540 ) Renewal



(511) 30

(210) No. 10371

(220) 07/07/2003

(732) PHIBOONCHAI MAEPRANOM THAI  
CHILI PASTE CO., LTD.

68/10 Moo 12, Boromrajchonnee Rd.,  
Salathammasop, Taweewattana, Bangkok  
10170, Thailand

(111) No. 9893

(180) 03/04/2044

( 540 ) Renewal



(511) 30

(210) No. 10373

(220) 07/07/2003

(732) PHIBOONCHAI MAEPRANOM THAI  
CHILI PASTE CO., LTD.

68/10 Moo 12, Boromrajchonnee Rd.,  
Salathammasop, Taweewattana, Bangkok  
10170, Thailand

(111) No. 9895

(180) 03/04/2044

( 540 ) Renewal



(511) 37

(210) No. 10411

(220) 04/08/2003

(732) ບໍລິສັດ ໄຟຟ້າ ນໍ້າເທີນ 2 ຈໍາກັດ.

ຖະໜົນສຸພານຸວົງ, ເຮືອນເລກທີ 388, ໜ່ວຍ 23,

ບ້ານ ອາກາດ, ເມືອງ ສີໂຄດຕະບອງ,

ນະຄອນຫຼວງວຽງຈັນ, ສປປ ລາວ

(111) No. 9933

(180) 05/04/2044

( 540 ) Renewal

**NAM THEUN 2**

(511) 37

(210) No. 10412

(220) 04/08/2003

(732) ບໍລິສັດ ໄຟຟ້າ ນໍ້າເທີນ 2 ຈໍາກັດ.

ຊັ້ນ 5 ແລະ 6 ຕຶກວິທະຍາ, ເຮືອນເລກທີ 249, ໜ່ວຍ

15, ຖະໜົນລາວ-ໄທ, ບ້ານ ວັດນາກ,

ເມືອງ ສີສັດຕະນາກ, ນະຄອນຫຼວງວຽງຈັນ, ສປປ ລາວ,

ຕໍ່ໄປສະນີ 5862

(111) No. 9934

(180) 05/04/2044

( 540 ) Renewal



(511) 34

(210) No. 10503

(220) 04/09/2003

(732) Imperial Tobacco Intellectual Property  
Limited

21 Beckett Way, Park West, Nangor Road,  
Dublin 12, Ireland

(111) No. 10024

(180) 03/09/2033

( 540 ) Renewal

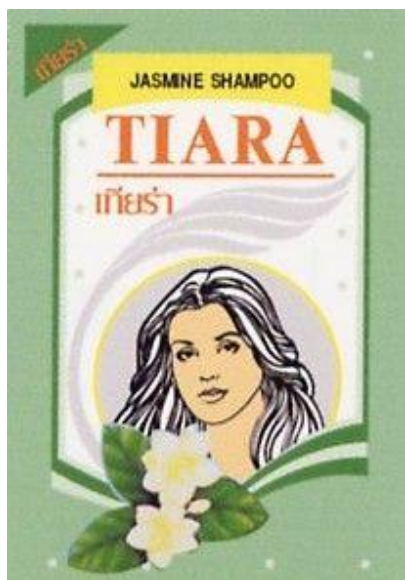

(511) 03

(210) No. 10578

(220) 01/10/2003

(732) NARAK-TIARA CO., LTD

, 1/9 Moo 2, Samut Sakhon Industrial Estate,  
Rama 2 Road, Tambon Tasai, Amphur  
Muang, Samut Sakhon 74000, Thailand

(111) No. 10100

(180) 05/04/2044

( 540 ) Renewal

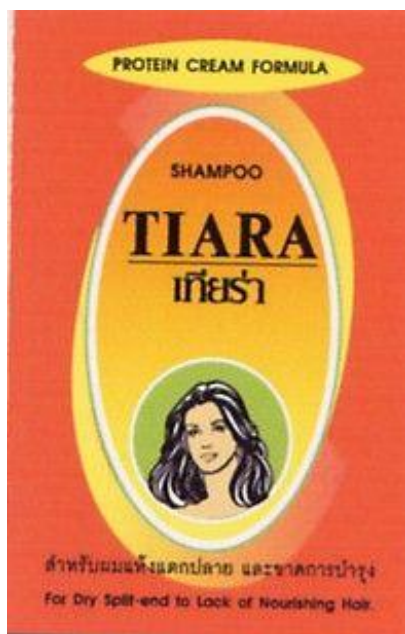

(511) 03

(210) No. 10579

(220) 01/10/2003

(732) NARAK-TIARA CO., LTD

1/9 Moo 2, Samut Sakhon Industrial Estate,  
Rama 2 Road, Tambon Tasai, Amphur  
Muang, Samut Sakhon 74000, Thailand

(111) No. 10101

(180) 05/04/2044

( 540 ) Renewal

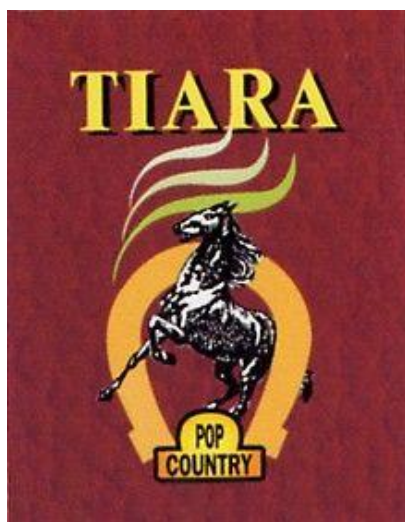

(511) 03

(210) No. 10580

(220) 01/10/2003

(732) NARAK-TIARA CO., LTD

, 1/9 Moo 2, Samut Sakhon Industrial Estate,  
Rama 2 Road, Tambon Tasai, Amphur  
Muang, Samut Sakhon 74000, Thailand

(111) No. 10102

(180) 05/04/2044

( 540 ) Renewal

**NT 2 IN LAO  
CHARACTERS**

(511) 37

(210) No. 10609

(220) 02/10/2003

(732) ບໍລິສັດ ໄຟຟ້າ ນໍ້າເທີນ 2 ຈຳກັດ.

ຊັ້ນ 5 ແລະ 6 ຕຶກວິທະຍາ, ເຮືອນເລກທີ 249, ໜ່ວຍ

15, ຖະໜົນລາວ-ໄທ, ບ້ານ ວັດນາກ, ເມືອງ

ສີສັດຕະນາກ, ນະຄອນຫຼວງວຽງຈັນ, ສປປ ລາວ,

ຕໍາໄປສະນີ 5862

(111) No. 10131

(180) 05/04/2044

( 540 ) Renewal

**NT2**

(511) 37

(210) No. 10610

(220) 02/10/2003

(732) ບໍລິສັດ ໄຟຟ້າ ນໍ້າເທີນ 2 ຈຳກັດ.

ຖະໜົນສຸພານຸວົງ, ເຮືອນເລກທີ 388, ໜ່ວຍ 23,

ບ້ານ ອາກາດ, ເມືອງ ສີໂຄດຕະບອງ,

ນະຄອນຫຼວງວຽງຈັນ, ສປປ ລາວ

(111) No. 10132

(180) 05/04/2044

( 540 ) Renewal

## **NTPC IN LAO CHARACTERS**

(511) 37

(210) No. 10615

(220) 06/10/2003

(732) ບໍລິສັດ ໄຟຟ້າ ນໍ້າເທີນ 2 ຈຳກັດ.

ຖະໜົນສຸພານຸວົງ, ເຮືອນເລກທີ 388, ໜ່ວຍ 23,

ບ້ານ ອາກາດ, ເມືອງ ສີໂຄດຕະບອງ,

ນະຄອນຫຼວງວຽງຈັນ, ສປປ ລາວ

(111) No. 10137

(180) 05/04/2044

( 540 ) Renewal

## **NUMTURN II**

(511) 37

(210) No. 10616

(220) 06/10/2003

(732) ບໍລິສັດ ໄຟຟ້າ ນໍ້າເທີນ 2 ຈຳກັດ.

ຊັ້ນ 5 ແລະ 6 ຕຶກວິທະຍາ, ເຮືອນເລກທີ 249, ໜ່ວຍ

15, ຖະໜົນລາວ-ໄທ, ບ້ານ ວັດນາກ,

ເມືອງ ສີສັດຕະນາກ, ນະຄອນຫຼວງວຽງຈັນ, ສປປ ລາວ,

ຕູ້ໄປສະນີ 5862

(111) No. 10138

(180) 05/04/2044



( 540 ) Renewal

**TIGER AIRWAYS**

(511) 39

(210) No. 10889

(220) 07/01/2004

(732) Tigerair Taiwan Co., Ltd

No. 1, Hangzhan S. Road, Dayuan District,  
Taoyuan City 337041, Taiwan (R.O.C)

(111) No. 10392

(180) 04/04/2044

( 540 ) Renewal

**C & C**

(511) 12

(210) No. 26725

(220) 18/06/2012

(732) C&C TRUCKS CO., LTD

No. 8 Huadian Avenue, Sanshan Area, Wuhu  
city, Anhui Province, P.R. China, 241080

(111) No. 26581

(180) 09/01/2033

( 540 ) Renewal

**C & C**

(511) 37

(210) No. 26726

(220) 18/06/2012

(732) C&C TRUCKS CO., LTD

No. 8 Huadian Avenue, Sanshan Area, Wuhu  
city, Anhui Province, P.R. China, 241080

(111) No. 26582

(180) 09/01/2033

( 540 ) Renewal

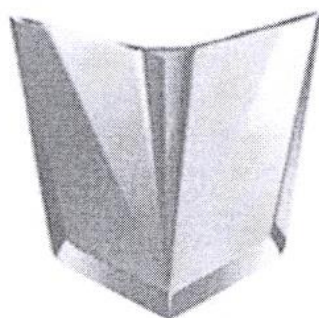

(511) 12

(210) No. 26727

(220) 18/06/2012

(732) C&C TRUCKS CO., LTD

No. 8 Huadian Avenue, Sanshan Area, Wuhu  
city, Anhui Province, P.R. China, 241080

(111) No. 26583

(180) 09/01/2033

( 540 ) Renewal

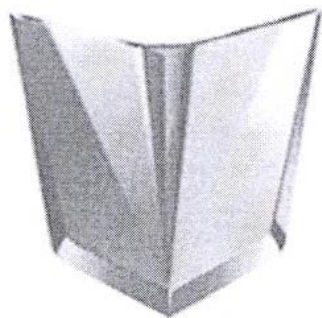

(511) 37

(210) No. 26728

(220) 18/06/2012

(732) C&C TRUCKS CO., LTD

No. 8 Huadian Avenue, Sanshan Area, Wuhu  
city, Anhui Province, P.R. China, 241080

(111) No. 26584

(180) 09/01/2033

( 540 ) Renewal



(511) 29

(210) No. 27035

(220) 27/07/2012

(732) BEL

2, allée de Longchamp, 92150 Suresnes,  
France

(111) No. 26855

(180) 21/03/2033

( 540 ) Renewal

**Hiruscar**

(511) 03

(210) No. 27927

(220) 05/12/2012

(732) MEDINOVA AG

Eggbühlstrasse 28, 8052 Zürich, Switzerland

(111) No. 27677

(180) 26/11/2033

( 540 ) Renewal

**Hiruscar**

(511) 05

(210) No. 27928

(220) 05/12/2012

(732) MEDINOVA AG

Eggbühlstrasse 28, 8052 Zürich, Switzerland

(111) No. 27678

(180) 26/11/2033

( 540 ) Renewal

**PARKER &  
SIMPSON**

(511) 34

(210) No. 28080

(220) 14/12/2012

(732) Imperial Tobacco Intellectual Property Limited  
21 Beckett Way, Park West, Nangor Road,  
Dublin 12, Ireland

(111) No. 27825

(180) 27/11/2033

( 540 ) Renewal

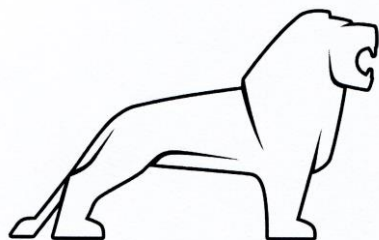

(511) 12

(210) No. 28421

(220) 18/01/2013

(732) MAN TRUCK & BUS AG  
Dachauer Strasse 667 Munchen 80995,  
Germany

(111) No. 28061

(180) 09/12/2033

( 540 ) Renewal

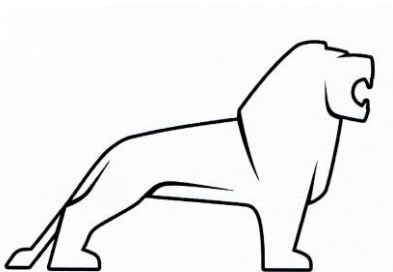

(511) 25

(210) No. 28422

(220) 18/01/2013

(732) MAN Truck & Bus SE

Dachauer StraBe 667,80995 Munchen,  
Germany

(111) No. 28062

(180) 09/12/2033

( 540 ) Renewal

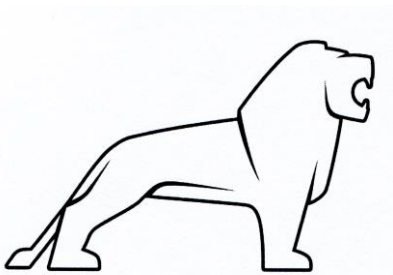

(511) 36

(210) No. 28423

(220) 18/01/2013

(732) MAN Truck & Bus SE

Dachauer StraBe 667,80995 Munchen,  
Germany

(111) No. 28063

(180) 09/12/2033

( 540 ) Renewal

**ilike**

(511) 09

(210) No. 30745

(220) 05/11/2013

(732) GuangDong OPPO Mobile

Telecommunications Corp., Ltd.

No. 18 Haibin Road, Wusha, Chang'an,

Dongguan, Guangdong, China

(111) No. 30470

(180) 17/12/2034

( 540 ) Renewal



(511) 37

(210) No. 31160

(220) 25/12/2013

(732) ບໍລິສັດ ໄຟຟ້າ ນໍ້າເທີນ 2 ຈໍາກັດ

ຖະໜົນສຸພານຸວົງ, ເຮືອນເລກທີ 388, ໜ່ວຍ 23,

ບ້ານ ອາກາດ, ເມືອງ ສີໂຄດຕະບອງ,

ນະຄອນຫຼວງວຽງຈັນ, ສປປ ລາວ

(111) No. 30833

(180) 18/12/2034

( 540 ) Renewal

## Powering the Future

(511) 37

(210) No. 31161

(220) 25/12/2013

(732) ບໍລິສັດ ໄຟຟ້າ ນໍ້າເທີນ 2 ຈຳກັດ

ຊັ້ນ 5 ແລະ 6 ຕຶກວິທະຍາ, ເຮືອນເລກທີ 249, ໜ່ວຍ

15, ຖະໜົນລາວ-ໄທ, ບ້ານ ວັດນາກ,

ເມືອງ ສີສັດຕະນາກ, ນະຄອນຫຼວງວຽງຈັນ, ສປປ ລາວ,

ຕໍາໜ່ວຍ 5862

(111) No. 30834

(180) 18/12/2034

( 540 ) Renewal

## ພະລັງແຫ່ງອະນາຄົດ

(511) 37

(210) No. 31162

(220) 25/12/2013

(732) ບໍລິສັດ ໄຟຟ້າ ນໍ້າເທີນ 2 ຈຳກັດ

ຊັ້ນ 5 ແລະ 6 ຕຶກວິທະຍາ, ເຮືອນເລກທີ 249, ໜ່ວຍ

15, ຖະໜົນລາວ-ໄທ, ບ້ານ ວັດນາກ,

ເມືອງ ສີສັດຕະນາກ, ນະຄອນຫຼວງວຽງຈັນ, ສປປ

ລາວ, ຕໍາໜ່ວຍ 5862

(111) No. 30835

(180) 18/12/2034



**ພາກທີ III**  
**(Part III)**

**ເຄື່ອງໝາຍການຄ້າ**  
**Trademarks**

**4. ການປ່ຽນແປງ**  
**(Changes)**

**ພາກທີ III**

**(Part III)**

**ເຄື່ອງໝາຍການຄ້າ**

**Trademarks**

**5. ການດັດແກ້**

**(Amendments)**

## ພາກທີ IV

### (Part IV)

## ເຄື່ອງໝາຍການຄ້າຜ່ານລະບົບມາດຣິດ

### Trademarks via Madrid Protocol

#### 1. ຄໍາຮ້ອງ

#### (Applications)

##### ຄໍາອະທິບາຍກ່ຽວກັບລະຫັດຫຍໍ້

##### (Introduction of Codes)

- (540) ເຄື່ອງໝາຍການຄ້າ (Trademark)
- (511) ໝວດ (Nice Classification)
- (210) ເລກທີ ຄໍາຮ້ອງ (Number of the application)
- (220) ວັນທີ ຄໍາຮ້ອງ (Date of filing of the application)
- (732) ຊື່ ແລະ ທີ່ຢູ່ ຂອງຜູ້ຍື່ນຄໍາຮ້ອງ (Name and Address of applicant)

( 540 )

**AQUA FUSION**

(511) 03

(210) No. M/0819320

(220) 04/03/2024

(732) L'OREAL

14 rue Royale F-75008 PARIS, France

( 540 )

**INQOVI**

(511) 05

(210) No. M/1523798

(220) 13/03/2024

(732) TAIHO PHARMACEUTICAL CO., LTD.

1-27 Kandanishiki-cho, Chiyoda-ku Tokyo

101-8444, Japan

( 540 )

**TSAR BOMBA**

(511) 14

(210) No. M/1658536

(220) 13/03/2024

(732) GongJue Brand management (Guangzhou)

Co., Ltd

Room 503, No. 3, Yinglong Road, Tianhe

District, Guangzhou 510000 Guangdong

Province, China

( 540 )

**DATVERZO**

(511) 05

(210) No. M/1659335

(220) 06/03/2024

(732) DAIICHI SANKYO COMPANY, LIMITED

3-5-1, Nihonbashi Honcho, Chuo-ku Tokyo

103-8426, Japan

( 540 )

**DATROWAY**

(511) 05

(210) No. M/1659337

(220) 06/03/2024

(732) DAIICHI SANKYO COMPANY, LIMITED

3-5-1, Nihonbashi Honcho, Chuo-ku Tokyo

103-8426, Japan

( 540 )

**JEMLYNK**

(511) 05

(210) No. M/1659338

(220) 06/03/2024

(732) DAIICHI SANKYO COMPANY, LIMITED

3-5-1, Nihonbashi Honcho, Chuo-ku Tokyo

103-8426, Japan

( 540 )

The logo for JEMLYNK features the word "JEMLYNK" in a bold, blue, sans-serif font. The letter "Y" is stylized with a light blue and yellow gradient. To the right of the text is a circular icon composed of overlapping yellow and blue segments.

(511) 05 and 44

(210) No. M/1721543

(220) 06/03/2024

(732) DAIICHI SANKYO COMPANY, LIMITED

3-5-1, Nihonbashi Honcho, Chuo-ku Tokyo

103-8426, Japan

( 540 )

The logo for DATROWAY features the word "DATROWAY" in a bold, blue, sans-serif font. The letter "O" is stylized with a yellow and blue gradient.

(511) 05 and 44

(210) No. M/1721544

(220) 06/03/2024

(732) DAIICHI SANKYO COMPANY, LIMITED

3-5-1, Nihonbashi Honcho, Chuo-ku Tokyo

103-8426, Japan

( 540 )

**carl vinson**

(511) 14

(210) No. M/1781834

(220) 23/10/2023

(732) Shenzhen Dianshi Clock Co., Ltd.

2nd Floor, Building C2, Gushu Industrial  
Zone, Hangkong Road, Sanwei Community,  
Hangcheng Street, Baoan District, Shenzhen  
City Guangdong Province, China

( 540 )

**QPOWER**

(511) 12

(210) No. M/1782043

(220) 26/12/2023

(732) Chery Automobile Co., Ltd.

No.8 Changchun Road, Economy &  
Technology Development Zone, Wuhu City  
241009 Anhui Province, China



( 540 )

**PatchIM**

(511) 16

(210) No. M/1782074

(220) 27/12/2023

(732) Jiangmen Dascom Computer Peripherals Co.,  
Ltd.

No. 399 Jinxing Road, Jianghai District,

Jiangmen City Guangdong Province, China

( 540 )

**EVERSWEET**

(511) 21

(210) No. M/1782079

(220) 28/12/2023

(732) PETKIT Network Technology (Shanghai)  
Co., Ltd.

Room 4139, Building 2, No. 588, Zixing

Road, Minhang District 201100 Shanghai,

China

( 540 )



**PAULO PEDRO**

(511) 25

(210) No. M/1782180

(220) 08/01/2024

(732) Lin Xiaodong

Room 908-909, 9th Floor, Building 8, No.48

Jiuhuan Road, Shangcheng District,

Hangzhou City Zhejiang Province, China

( 540 )

**SKYWORTH**

(511) 12

(210) No. M/1782248

(220) 06/11/2023

(732) Skywell New Energy Vehicles Group Co.,

Ltd.

No. 369 Binhuai Road, Lishui District,

Nanjing Jiangsu, China

( 540 )

**鮑 师 傅**  
**BAO'S PASTRY**

(511) 30 and 43

(210) No. M/1782261

(220) 12/01/2024

(732) BEIJING BAOCAISHENG CATERING  
MANAGEMENT CO., LTD.

Room 3009, Unit 1, 26 F, Building No.99,  
Chaoyang North Road, Chaoyang District  
100000 Beijing, China

( 540 )

  
**MAYSTA**

(511) 01

(210) No. M/1782382

(220) 28/12/2023

(732) Jiangsu Maysta Chemical Co., Ltd.

7/F and 8/F, Building A3, Huizhi Science and  
Technology Park, No. 8 Hengtai Road,  
Nanjing Economic and Technological  
Development Zone, Nanjing City 210046  
Jiangsu, China

( 540 )



(511) 09, 18, 25 and 28

(210) No. M/1782394

(220) 15/09/2023

(732) Wilson Sporting Goods Co.

130 East Randolph Street, Suite 600 Chicago  
IL 60601, United States of America

( 540 )



(511) 08, 11, 21 and 35

(210) No. M/1782625

(220) 04/12/2023

(732) Yiwu Daling Electrical Appliance Co., Ltd.

Room 301, Unit 5, Building 11#, Dayuancun  
Garden, Jiangdong Street, Yiwu Zhejiang,  
China

( 540 )



(511) 06 and 09  
(210) No. M/1782674  
(220) 11/12/2023  
(732) Zhejiang Hongli Locks Co., Ltd.  
No.5 Chengda Road, Shuige Industrial Area,  
Lishui Zhejiang, China

( 540 )

**HOPEWIND**

(511) 07 and 09  
(210) No. M/1782690  
(220) 01/11/2023  
(732) Shenzhen Hopewind Electric Co., Ltd.  
Room 609, West Block, 6th Floor, Tian' an  
Innovation and Technology Plaza (Phase II),  
Intersection of Binhe Road and Xiangmihu  
Road Tian' an Community, China

( 540 )

**NEURIO**

(511) 05, 29, 30 and 35

(210) No. M/1782691

(220) 12/12/2023

(732) Guangzhou Aotea Biological Technology Pte  
Ltd.

B108 is Compiled in 1102, No. 8, Jinsui Road,  
Tianhe District, Guangzhou Guangdong, China

( 540 )

**ADA OVERLAND**

(511) 06, 11 and 20

(210) No. M/1782729

(220) 06/01/2024

(732) Zhejiang Ada Outdoor Products Co.,Ltd.

Floor 1-3, South Factory Building, No. 66,  
Dangui South Road, Xicheng Street,  
Yongkang City, Jinhua City 321300 Zhejiang  
Province, China

( 540 )

**MEMOLEAD**

(511) 01 and 03

(210) No. M/1782732

(220) 14/02/2024

(732) KAO KABUSHIKI KAISHA (also trading as  
Kao Corporation)

14-10, Nihonbashi Kayabacho 1-chome,  
Chuo-ku Tokyo 103-8210, Japan

( 540 )



(511) 41

(210) No. M/1782883

(220) 12/01/2024

(732) Islamic Tourism Centre

Level 13, Ministry Of Tourism, Arts &  
Culture Malaysia, No. 2, Tower 1, Jalan P5/6,  
Precint 5 62200 Wilayah Persekutuan Kuala  
Lumpur, Malaysia

( 540 )



(511) 36 and 41

(210) No. M/1782972

(220) 15/01/2024

(732) Fondation JUNICLAIR

4-6, rue du Fort Rheinsheim L-2419

Luxembourg

( 540 )

**BONO**

(511) 18 and 25

(210) No. M/1783013

(220) 25/01/2024

(732) Shanghai Baoniao Garments Co., Ltd.

No. 631 Jinxi Road, Industrial Zone,

Songjiang District 200000 Shanghai, China



( 540 )

**SINODRILLS**

(511) 07

(210) No. M/1783052

(220) 24/01/2024

(732) Guizhou Sinodrills Equipment Co., Ltd.

No. 7, 16th Floor, Building 1, Xiaweiqing

Road, Yunyan District, Guiyang City 550001

Guizhou Province, China

( 540 )

**森合高科**  
SENHE HIGH TECHNOLOGY

(511) 01

(210) No. M/1783055

(220) 19/01/2024

(732) Guangxi Senhe High-tech Co., Ltd.

West of B-3-1, Mingyang 4th Road,

Mingyang Industrial Zone, Nanning City

530000 Guangxi Zhuang Autonomous

Region, China

( 540 )

**ABYSEA**

(511) 25

(210) No. M/1783056

(220) 29/12/2023

(732) GuangDong PanThink Footwear Co., Ltd  
East Rd. Industry Zone, Litang 2nd Village,  
Caitang Town, Chao'an District, Chaozhou  
515644 Guangdong, China

## ພາກທີ IV

### (Part IV)

## ເຄື່ອງໝາຍການຄ້າຜ່ານລະບົບມາດຣິດ

### Trademarks via Madrid Protocol

## 2. ຜົນການຈົດທະບຽນ

### (Registration)

#### ຄໍາອະທິບາຍກ່ຽວກັບລະຫັດຫຍໍ້

#### (Introduction of Codes)

- (540) ເຄື່ອງໝາຍການຄ້າ (Trademark)
- (511) ໝວດ (Nice Classification)
- (210) ເລກທີ ຄໍາຮ້ອງ (Number of the application)
- (220) ວັນທີ ຍື່ນຄໍາຮ້ອງ (Date of filing of the application)
- (732) ຊື່ ແລະ ທີ່ຢູ່ ຂອງຜູ້ຍື່ນຄໍາຮ້ອງ (Name and Address of applicant)
- (111) ເລກທີການຈົດທະບຽນເຄື່ອງໝາຍການຄ້າ (Number of the registration)
- (180) ວັນໝົດອາຍຸຂອງການຈົດທະບຽນ (Expiration date of the registration)

( 540 )

**RICOTA**

(511) 06, 07, 08, 09, 11 and 35

(210) No. M/1572875

(220) 24/07/2020

(732) CHONGQING AMITY MACHINERY CO.,  
LTD.

No. 200 Zhongshan 2 Road, Yuzhong District  
400014 Chongqing, China

(111) No. M/1572875

(180) 24/07/2030

## ພາກທີ IV

### (Part IV)

## ເຄື່ອງໝາຍການຄ້າຜ່ານລະບົບມາດຣິດ

### Trademarks via Madrid Protocol

#### 3. ຜົນການຕໍ່ອາຍຸ

##### (Renewal)

##### ຄໍາອະທິບາຍກ່ຽວກັບລະຫັດຫຍໍ້

##### (Introduction of Codes)

- (540) ເຄື່ອງໝາຍການຄ້າ (Trademark)
- (511) ໝວດ (Nice Classification)
- (210) ເລກທີ ຄໍາຮ້ອງ (Number of the application)
- (220) ວັນທີ ຍື່ນຄໍາຮ້ອງ (Date of filing of the application)
- (732) ຊື່ ແລະ ທີ່ຢູ່ ຂອງຜູ້ຍື່ນຄໍາຮ້ອງ (Name and Address of applicant)
- (111) ເລກທີການຈົດທະບຽນເຄື່ອງໝາຍການຄ້າ (Number of the registration)
- (180) ການຕໍ່ອາຍຸຂອງການຈົດທະບຽນ (Expiration date of the renewal)

**ພາກທີ IV**

**(Part IV)**

**ເຄື່ອງໝາຍການຄ້າຜ່ານລະບົບມາດຣິດ**

**Trademarks via Madrid Protocol**

**4. ການປ່ຽນແປງ**

**(Changes)**

**ພາກທີ IV**

**(Part IV)**

**ເຄື່ອງໝາຍການຄ້າຜ່ານລະບົບມາດຣິດ**

**Trademarks via Madrid Protocol**

**5. ການດັດແກ້**

**(Amendments)**

**ພາກທີ V**  
**(Part V)**  
**ຖິ່ນກຳເນີດ**  
**Geographical Indications**

**1. ຄຳຮ້ອງ**  
**(Applications)**



ພາກທີ V  
(Part V)  
ຖິ່ນກຳເນີດ  
Geographical Indications

2. ຜົນການຈັດທະບຽນ  
(Registration)

**ພາກທີ V**  
**(Part V)**  
**ຖິ່ນກຳເນີດ**  
**Geographical Indications**

**2.1 ຜົນການຈົດທະບຽນ ຜ່ານລະບົບສາກົນ**  
**(Lisbon Registration)**

**ພາກທີ V**  
**(Part V)**  
**ຖິ່ນກຳເນີດ**  
**Geographical Indications**

**2.2 ຜົນການຈົດທະບຽນ ຊື່ຖິ່ນກຳເນີດສະເພາະ ຜ່ານລະບົບສາກົນ**  
**(Lisbon Appellation of Origin Registration)**

**ພາກທີ V**

**(Part V)**

**ຖິ່ນກຳເນີດ**

**Geographical Indications**

**3. ການປ່ຽນແປງ**

**(Changes)**

**ພາກທີ V**  
**(Part V)**  
**ຖິ່ນກຳເນີດ**  
**Geographical Indications**

**4. ການດັດແກ້**  
**(Amendments)**

**ພາກທີ VI**

**(Part VI)**

**ພັນພືດໃໝ່**

**New Plant Varieties**

**1. ຄໍາຮ້ອງ**

**(Applications)**

**ພາກທີ VI**

**(Part VI)**

**ພັນພືດໃໝ່**

**New Plant Varieties**

**2. ຜົນການຈັດທະບຽນ**

**(Registration)**

**ພາກທີ VI**  
**(Part VI)**

**ພັນພືດໃໝ່**  
**New Plant Varieties**

**3. ການປ່ຽນແປງ**  
**(Changes)**



**ພາກທີ VI**

**(Part VI)**

**ພັນພືດໃໝ່**

**New Plant Varieties**

**4. ການດັດແກ້**

**(Amendments)**

## ພາກທີ VII

### (Part VII)

## ລິຂະສິດ ແລະ ສິດກ່ຽວຂ້ອງກັບລິຂະສິດ

### Copyrights and Related Rights

#### 1. ການແຈ້ງຂໍ້ມູນ

##### (Notifications)

**ພາກທີ VII**

**(Part VII)**

**ລິຂະສິດ ແລະ ສິດກ່ຽວຂ້ອງກັບລິຂະສິດ**

**Copyrights and Related Rights**

**2. ການປ່ຽນແປງ**

**(Changes)**

## ພາກທີ VIII

### (Part VIII)

ການແກ້ໄຂຂໍ້ຂັດແຍ່ງທາງດ້ານບໍລິຫານກ່ຽວກັບການຈົດ

ທະບຽນຊັບສິນອຸດສາຫະກຳ ແລະ ພັນພືດໃໝ່

Administrative Dispute Resolutions on the Registration of  
Industrial Property and New Plant Varieties

#### 1. ຜົນການຄັດຄ້ານຄຳຮ້ອງ

(Result of Oppositions)

## ພາກທີ VIII

### (Part VIII)

ການແກ້ໄຂຂໍ້ຂັດແຍ່ງທາງດ້ານບໍລິຫານກ່ຽວກັບການຈົດ

ທະບຽນຊັບສິນອຸດສາຫະກຳ ແລະ ພັນພືດໃໝ່

Administrative Dispute Resolutions on the Registration of  
Industrial Property and New Plant Varieties

#### 2. ຜົນການແຈ້ງປະຕິເສດ

(Result of Refusals)

## ພາກທີ VIII

### (Part VIII)

ການແກ້ໄຂຂໍ້ຂັດແຍ່ງທາງດ້ານບໍລິຫານກ່ຽວກັບການຈົດ  
ທະບຽນຊັບສິນອຸດສາຫະກຳ ແລະ ພັນພືດໃໝ່

Administrative Dispute Resolutions on the Registration of  
Industrial Property and New Plant Varieties

3. ຜົນການຍົກເລີກ ຫຼື ລົບລ້າງ ຂອງການຈົດທະບຽນ  
(Result of Cancellation or Invalidation of Registration)