



ສາທາລະນະລັດ ປະຊາທິປະໄຕ ປະຊາຊົນລາວ  
LAO PEOPLE'S DEMOCRATIC REPUBLIC

ກະຊວງ ອຸດສາຫະກຳ ແລະ ການຄ້າ  
ກົມຊັບສິນທາງປັນຍາ  
MINISTRY OF INDUSTRY AND COMMERCE  
DEPARTMENT OF INTELLECTUAL PROPERTY

ຈົດໝາຍເຫດທາງລັດຖະການ  
ກ່ຽວກັບ ຊັບສິນທາງປັນຍາ  
ຢູ່ ສປປ ລາວ

OFFICIAL GAZETTE ON INTELLECTUAL PROPERTY  
IN LAO PDR

# ພາກທີ I

## (Part I)

### ສິດທິບັດ ແລະ ອະນຸສິດທິບັດ (Patent and Petty Patent)

#### 1. ຄໍາຮ້ອງ (Applications)

##### ຄໍາອະທິບາຍກ່ຽວກັບລະຫັດຫຍໍ້ (Introduction of Codes)

- (21) ເລກທີ ຄໍາຮ້ອງ (Filing Number)
- (22) ວັນທີ ຍືນຄໍາຮ້ອງ (Filing Date)
- (30) ວັນທີ ບຸລິມະສິດ (Priority Date)
- (43) ວັນທີເຜີຍແຜ່ (Publication Date)
- (51) ໝວດ (International Patent Classification)
- (54) ຊື່ຂອງການປະດິດ (Title)
- (57) ບົດຄັດຫຍໍ້ (Abstract)
- (71) ຊື່ ແລະ ທີ່ຢູ່ ເຈົ້າຂອງສິດທິບັດ ແລະ ອະນຸສິດທິບັດ (Owner Name and Address)
- (72) ຊື່ຜູ້ປະດິດ (Inventor Name)
- (74) ຊື່ຕົວແທນ (Representative Name)
- (55) ຮູບພາບ (Pictures)

# ພາກທີ I

## (Part I)

### ສິດທິບັດ ແລະ ອະນຸສິດທິບັດ (Patent and Petty Patent)

#### 2. ຜົນການອອກສິດທິບັດ ແລະ ອະນຸສິດທິບັດ (Grant of Patents and Petty Patents)

##### ຄຳອະທິບາຍກ່ຽວກັບລະຫັດຫຍໍ້

##### (Introduction of Codes)

- (11) ເລກທີ (Grant Number)
- (21) ເລກທີ ຄຳຮ້ອງ (Filing Number)
- (22) ວັນທີຍືນຄຳຮ້ອງ (Filing Date)
- (30) ວັນທີ ບຸລິມະສິດ (Priority Date)
- (43) ວັນທີເຜີຍແຜ່ (Publication Date)
- (51) ໝວດ (International Patent Classification)
- (54) ຫົວຂໍ້ການປະດິດ (Title)
- (57) ບົດຄັດຫຍໍ້ (Abstract)
- (71) ຊື່ ແລະ ທີ່ຢູ່ ເຈົ້າຂອງສິດທິບັດ ແລະ ອະນຸສິດທິບັດ (Owner Name and Address)
- (72) ຊື່ຜູ້ປະດິດ (Inventor Name)
- (74) ຊື່ຕົວແທນ (Representative Name)
- (55) ຮູບພາບ (Pictures)

- (11) No. 414
- (21) PA 414
- (22) 12/02/2016
- (30)
- (43)
- (51) Int.Cl.8A 01G 31/00
- (54) ລະບົບການເພາະປູກພືດ ແລະວິທີການສຳລັບເພາະປູກພືດ
- (57) ເຕັກໂນໂລຊີຂອງວິຊາການວິທະຍາກ່ອນໜ້ານີ້ ມີປັນຫາເມື່ອພືດຖືກເພາະປູກເປັນໄລຍະເວລາດົນເທິງຝົມເຫຼົ້າໂປລີວິນິລ (PVA) ທີ່ມີຜືນຜິວດ້ານລຸ່ມຂອງມັນມີຕຳແໜ່ງຕິດຕໍ່ກັນຂອງແຫຼວທີ່ເປັນສານອາຫານ, ຮາກພືດທີ່ຖືກສ້າງຂຶ້ນ ຊອດຜ່ານຝົມ. ວິທີທາງເພື່ອແກ້ໄຂບັນຫາ ລະບົບການເພາະປູກພືດ (Plant cultivation system) ໃນທີ່ນັ້ນຝົມ ມີໂດຍທິຝົມ PVA ມີລະດັບສົມດຸນ (equilibrium degree) ຂອງການໄຂ່ບວມ ນຳໃນຂອບເຂດຈາກ 125-250 ເປີເຊັນຕາມການວັດແທກນຳທີ່ມີອຸນຫະພູມ 30 ອົງສາ ແລະ ມີຄ່າມູນຕັ້ງສຳລັບສູນເສຍ (tan ) ໃນຂອບເຂດຈາກ 0,005-0,2 ຕາມການວັດແທກໃນສະພາບໃຄ່ບວມ ສົມດຸນໃນນຳທີ່ 30 ອົງສາ ແລະ ວິທີການສຳລັບການເພາະປູກພືດ ໂດຍການໃຊ້ລະບົບການເພາະປູກພືດການປະຍຸກໃຊ້ທາງອຸດສາຫະກຳ ການເພາະປູກພືດ ສາມາດຖືກກະທຳໄດ້ເປັນໄລຍະເວລາດົນນານໃນຂະນະທີ່ຫຼີກລ້ຽງການຕິດເຊື້ອໂດຍແບັກທີເຣຍ ແລະ ທີ່ຄ້າຍກັນທີ່ເປັນ ສາເຫດຂອງໂລກພືດ. ເພາະສະນັ້ນ, ການປະດິດປະຈຸບັນເປັນປະໂຫຍດໃນດ້ານເຊັ່ນ: ການປູກຝັງ ແລະ ການຜະລິດ ທາງເພສັດຊະກຳ.
- (71) MEBIOL INC.  
1-25-8, Nakahara, Hiratsuka-shi, Kanagawa-ken, 254-0075 JAPAN, Japan.
- (72) Akihiro OKAMOTO; Hiroshi YOSHIOKA; Yuichi MORI; Shigeki MIURA and Tomoyoshi MIZUTANI.
- (74) Tilleke & Gibbins Lao Co., Ltd.
- (55)

- (11) No. 808
- (21) PA 808
- (22) 01/11/2021
- (30) 201911176393.0 26/11/2019 CN
- (43)
- (51) Int.Cl.H 04L 29/06(2006.01), H 04L 9/32(2006.01), H 04L 9/14(2006.01)
- (54) DATA ENCRYPTION AND DECRYPTION METHOD, DEVICE, STORAGE MEDIUM AND ENCRYPTED FILE
- (57) The present application relates to the technical field of data processing, and provided are methods and apparatuses for encrypting and decrypting data, a storage medium, and an encrypted file. The method for encrypting data comprises: acquiring a first key, and performing an obfuscation operation on the first key and data to be encrypted to obtain obfuscation operation result data; acquiring a second key, and obtaining a first signature of the obfuscation operation result data according to the second key; acquiring a third key, and using the third key to encrypt the first key, the data, and the first signature to obtain target ciphertext; acquiring a fourth key, and obtaining a second signature of the target ciphertext according to the fourth key; and generating an encrypted file comprising the target ciphertext and the second signature. The security of data protection may be improved by using the technical solution of the present application..
- (71) CHINA UNIONPAY CO., LTD.  
CUP Tower,36 Hanxiao Rd., Pudong New Area Shanghai 200135, People's Republic of China.
- (72) YANG, Sen; CHEN, Lin and XU, Bin.
- (74) CONCETTI-LAO CO., LTD.
- (55)

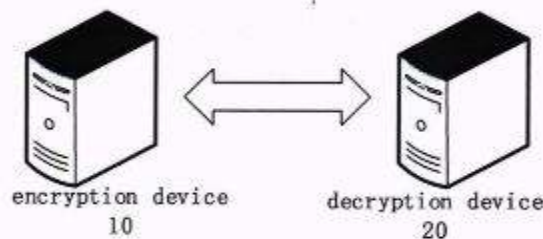

Fig. 1

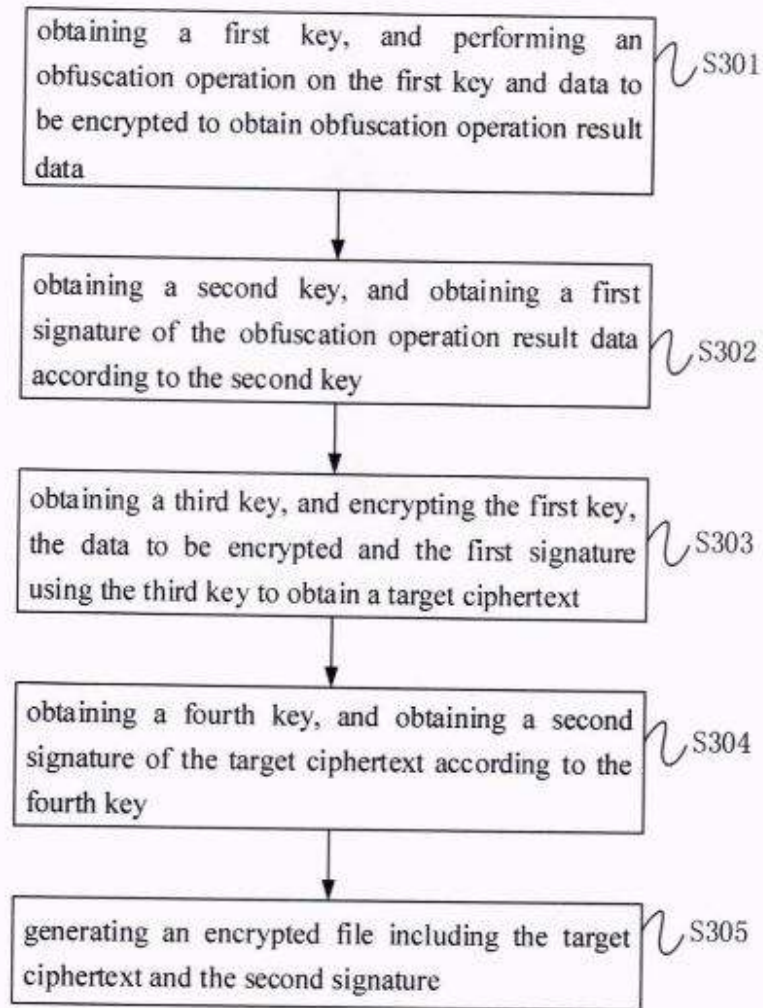

Fig. 2

1	# publicly available data
2	
3	target ciphertext
4	
5	second signature
6	

Fig. 3

1	# publicly available data
2	
3	first key
4	
5	sensitive data 1
6	sensitive data 2
7	sensitive data 3
8	
9	first signature
10	
11	second signature
12	

**Fig. 4**

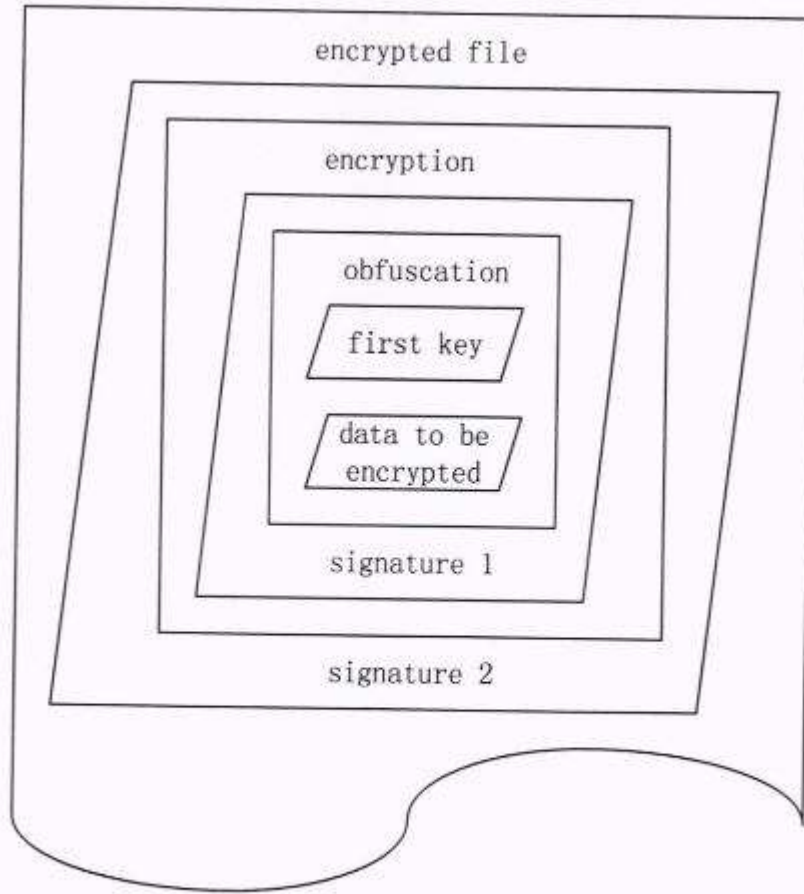

**Fig. 5**



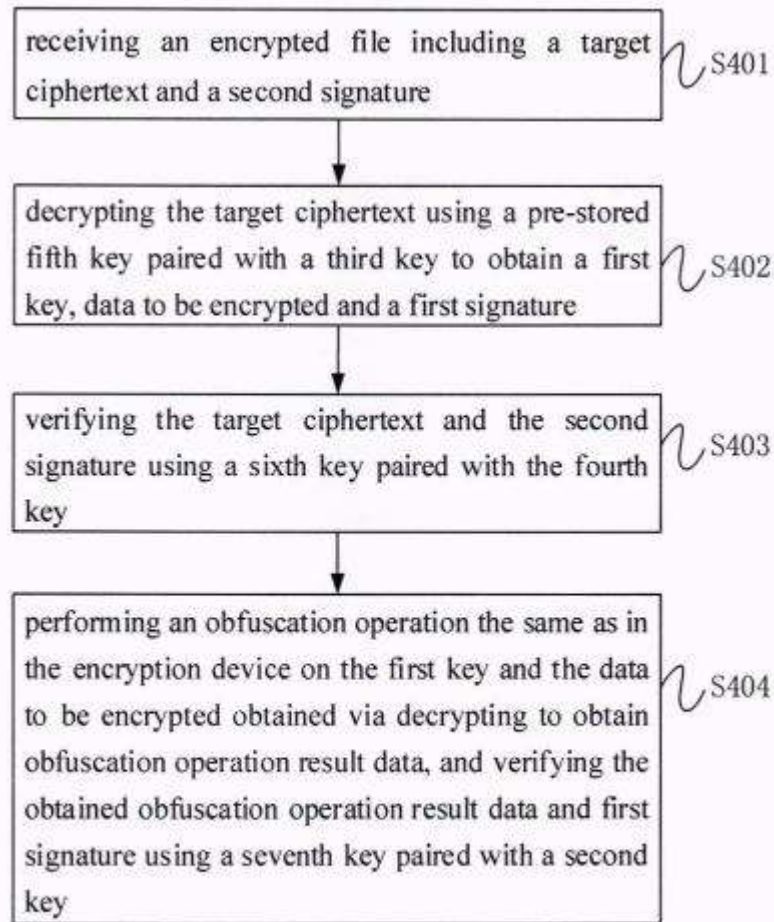

**Fig. 6**

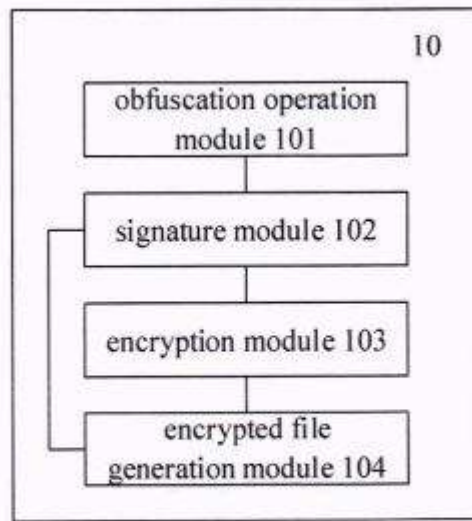

Fig. 7

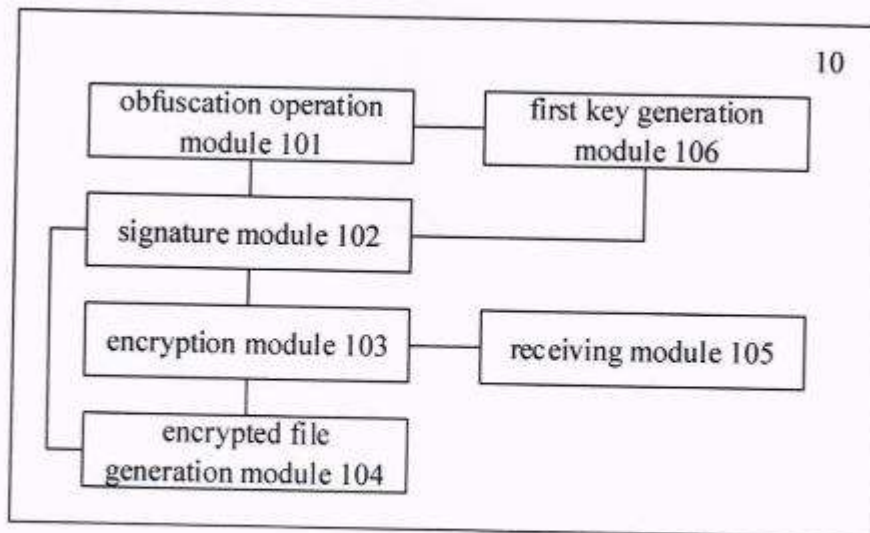

Fig. 8

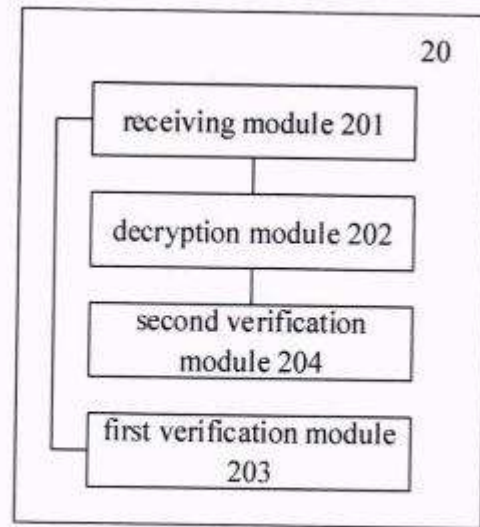

Fig. 9

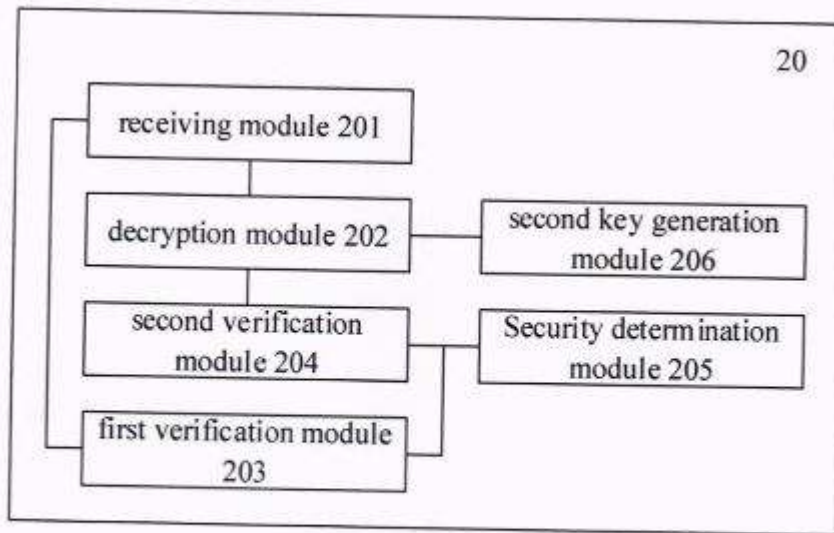

Fig. 10

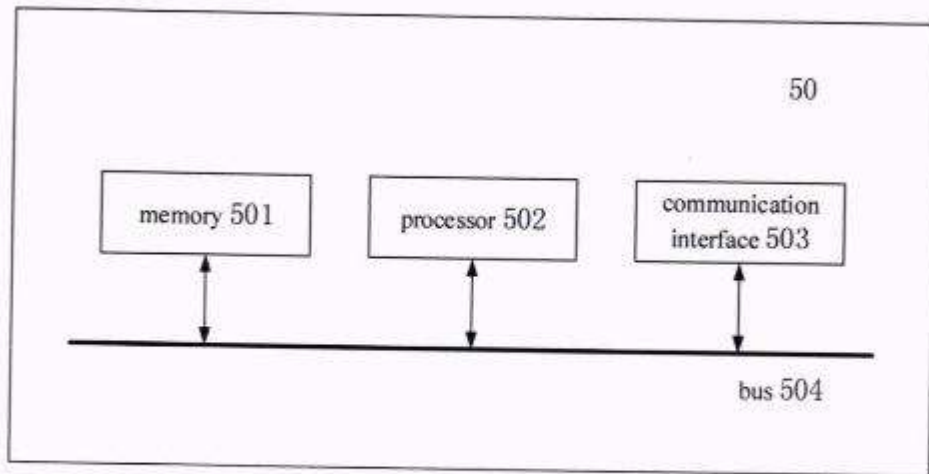

Fig. 11

- (11) No. 873
- (21) PA 873
- (22) 06/12/2022
- (30)
- (43)
- (51) Int.Cl.2018.01C 01D 3/08(2006.01)
- (54) Process and Equipment for Producing Potassium Chloride from Carnallite
- (57) The present invention provides process and equipment for producing potassium chloride using carnallite as the feedstock. The process of the present application comprises the following steps: crushing, washing, grinding, crystallizing, and direct flotation. In the present invention, by optimizing the process parameters and the process flow, industrial million-ton scale continuous production of potassium chloride from carnallite is achieved with high production efficiency, and significantly improved quality of the potassium chloride product, such as purity, whiteness, and crystal grain size.
- (71) Baichun GUO The third floor of the podium of Block C, Wanliu Yicheng Center, No.11 Changchunqiao Road, Haidian District, Beijing 100089 China, China.
- (72) Baichun GUO.
- (74) CONCETTI-LAO CO., LTD.
- (55)

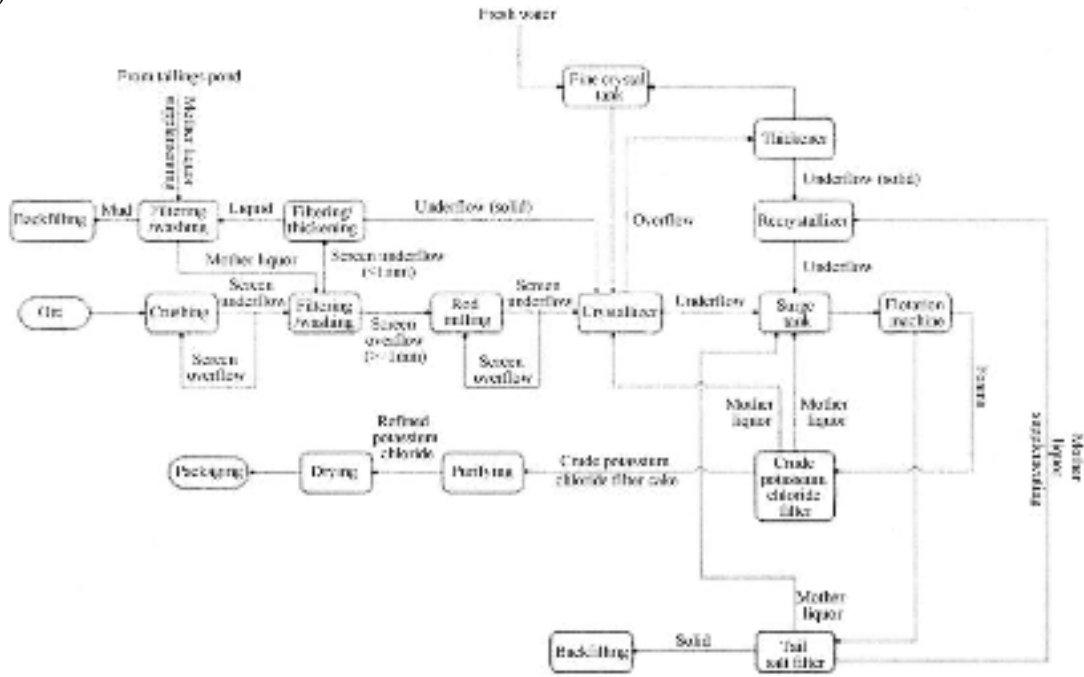

FIG.1

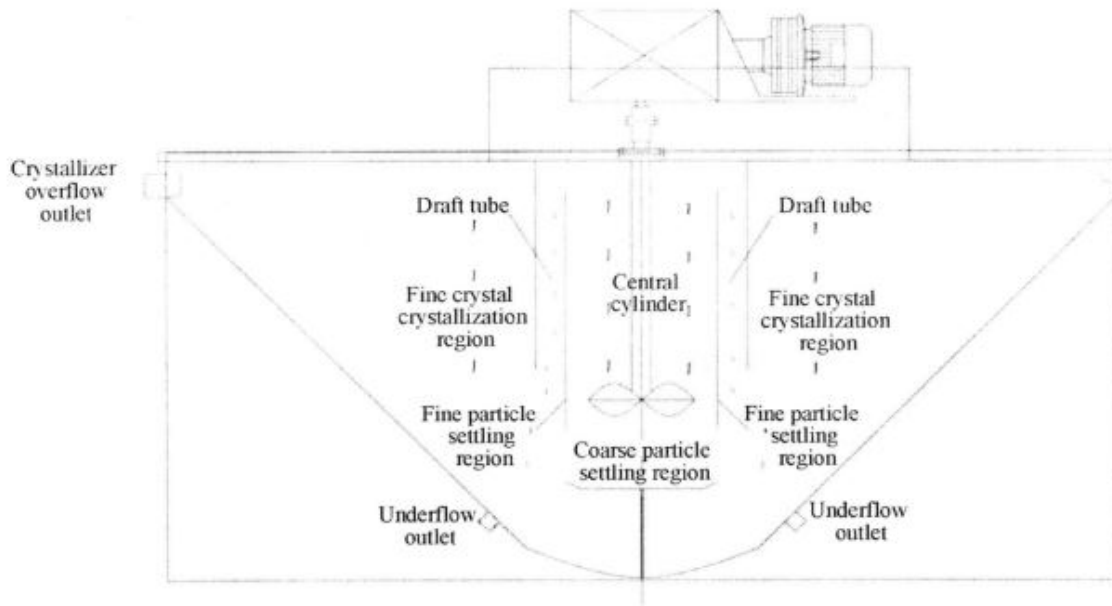

FIG.2

Official Gazette of Industrial Property Vol. 274, 24/10/2024

- (11) No. 874
- (21) PA 874
- (22) 07/12/2022
- (30)
- (43)
- (51) Int.Cl.2018.01G 10L 19/00(2013.01), G 10L 21/038(2013.01), G 10L 19/02(2013.01)
- (54) PROCESSING OF AUDIO SIGNALS DURING HIGH FREQUENCY RECONSTRUCTION
- (57) The application relates to HFR (High Frequency Reconstruction/Regeneration) of audio signals. In particular, the application relates to a method and system for performing HFR of audio signals having large variations in energy level across the low frequency range which is used to reconstruct the high frequencies of the audio signal. A system configured to generate a plurality of high frequency subband signals covering a high frequency interval from a plurality of low frequency subband signals is described. The system comprises means for receiving the plurality of low frequency subband signals; means for receiving a set of target energies, each target energy covering a different target interval within the high frequency interval and being indicative of the desired energy of one or more high frequency subband signals lying within the target interval; means for generating the plurality of high frequency subband signals from the plurality of low frequency subband signals and from a plurality of spectral gain coefficients associated with the plurality of low frequency subband signals, respectively; and means for adjusting the energy of the plurality of high frequency subband signals using the set of target energies.
- (71) Dolby International AB Mr. Treublaan 7 1097DP Amsterdam The Netherlands, The Netherlands.
- (72) KkJöRLING, Kristofer - Swedish.
- (74) ACTIP (LAO) IP CO., LTD.
- (55)

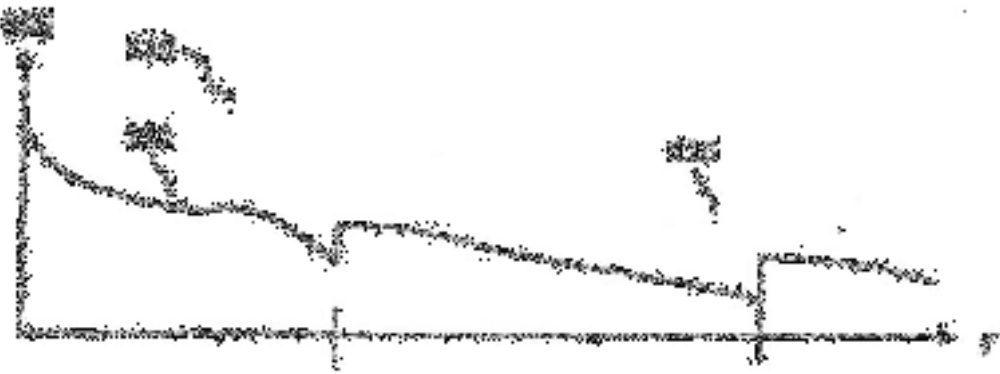
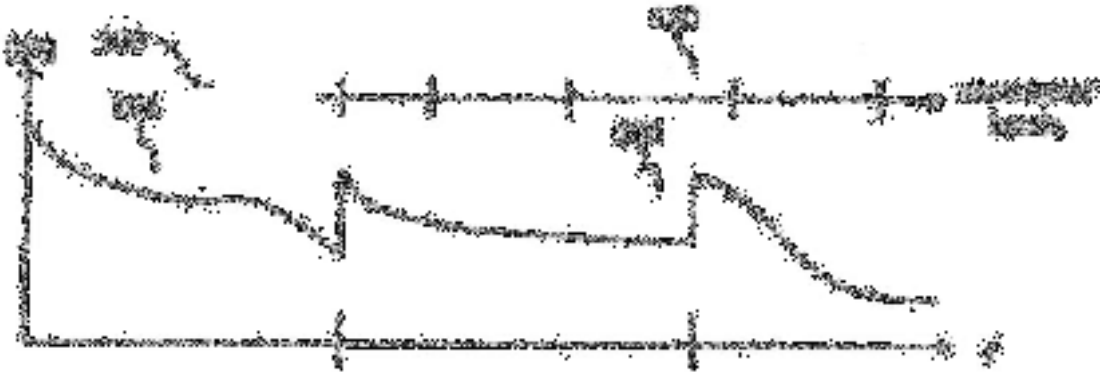

Fig. 1a



Fig. 1b



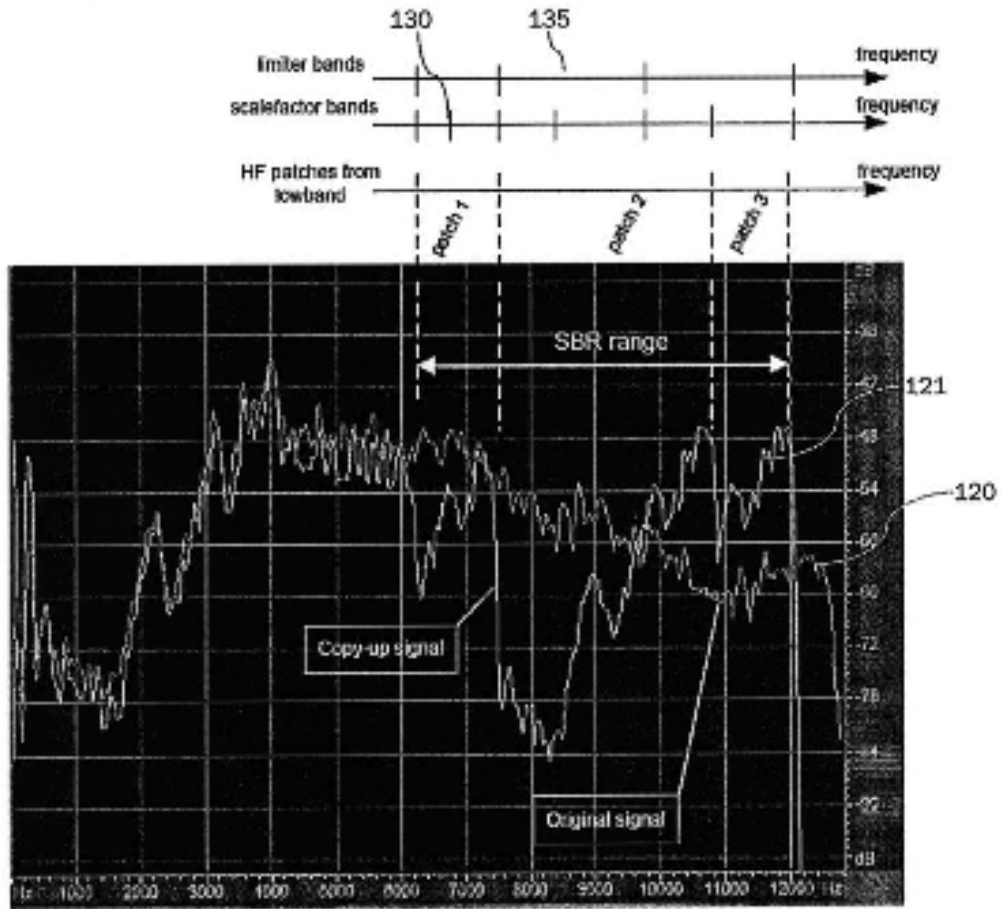
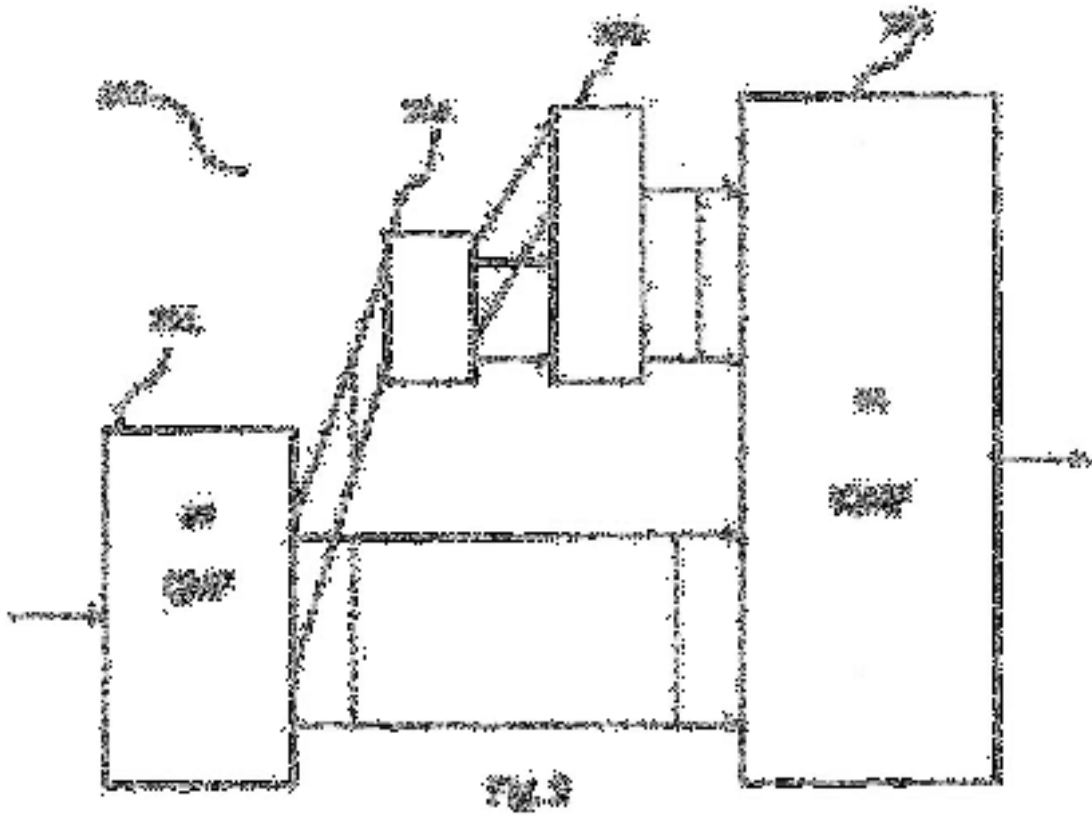

Fig. 1c



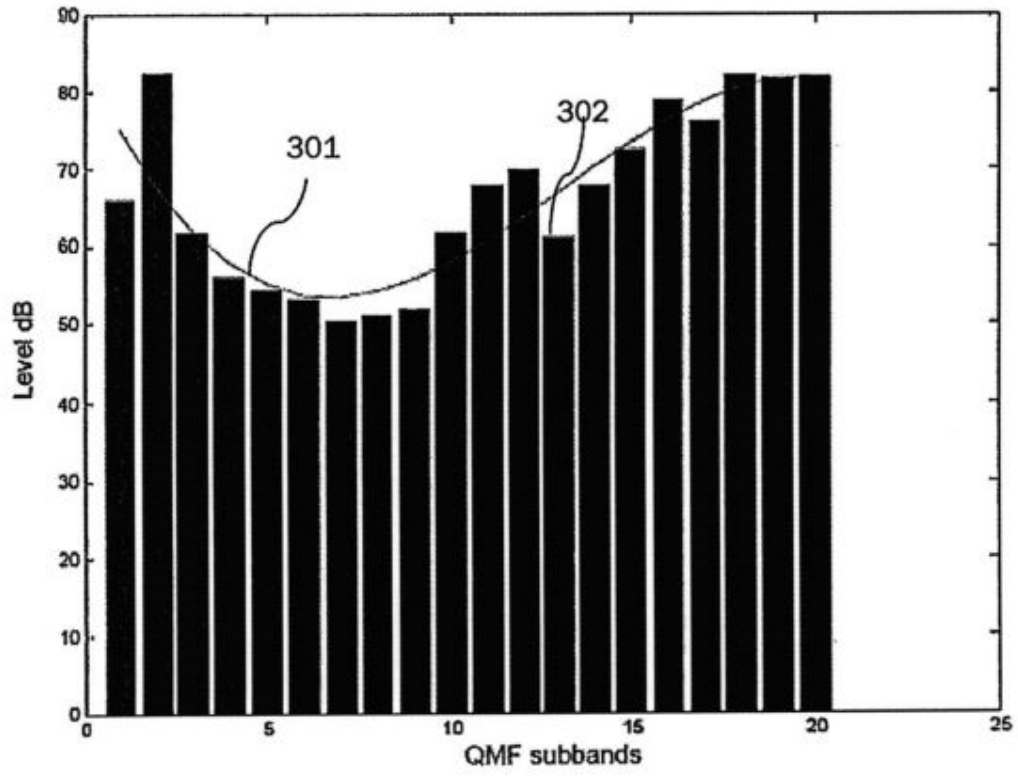

Fig. 3

3 / 8

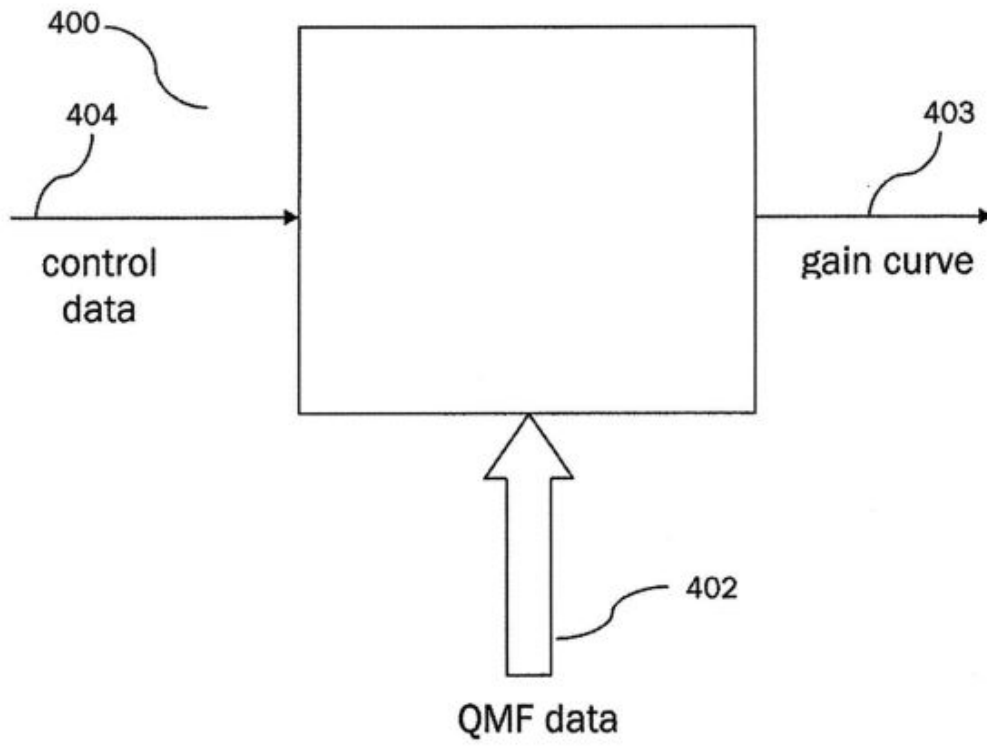

Fig. 4

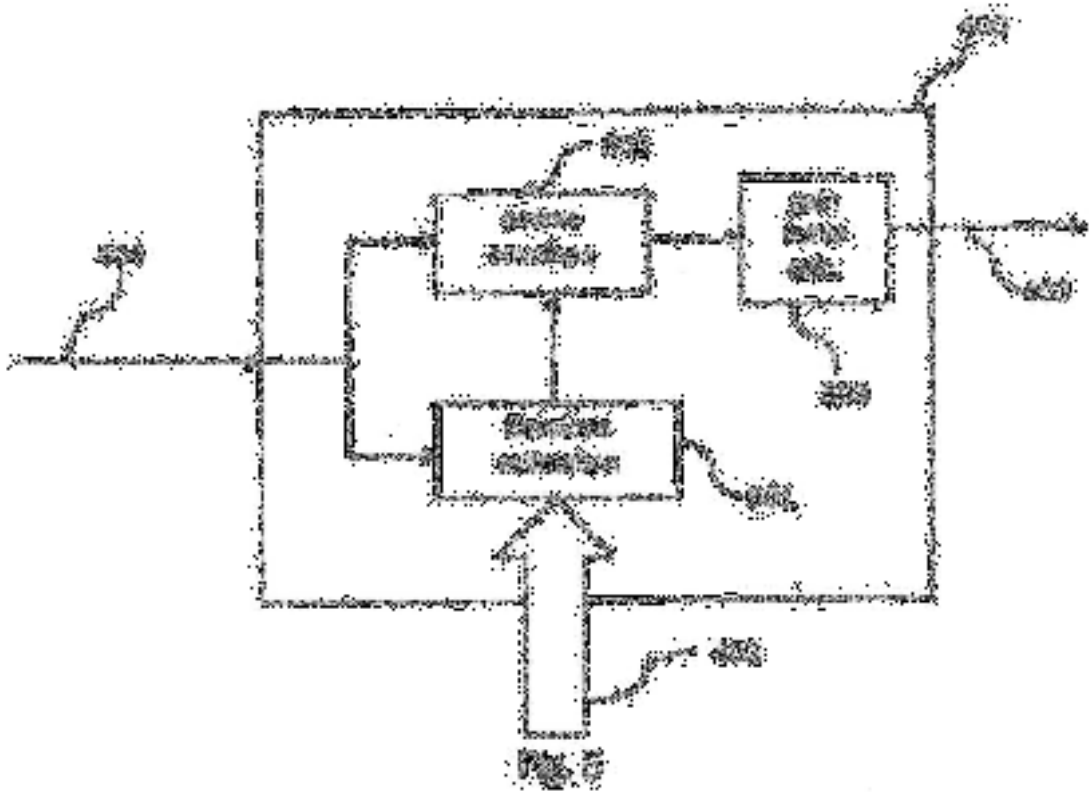

FIG. 3



FIG. 4

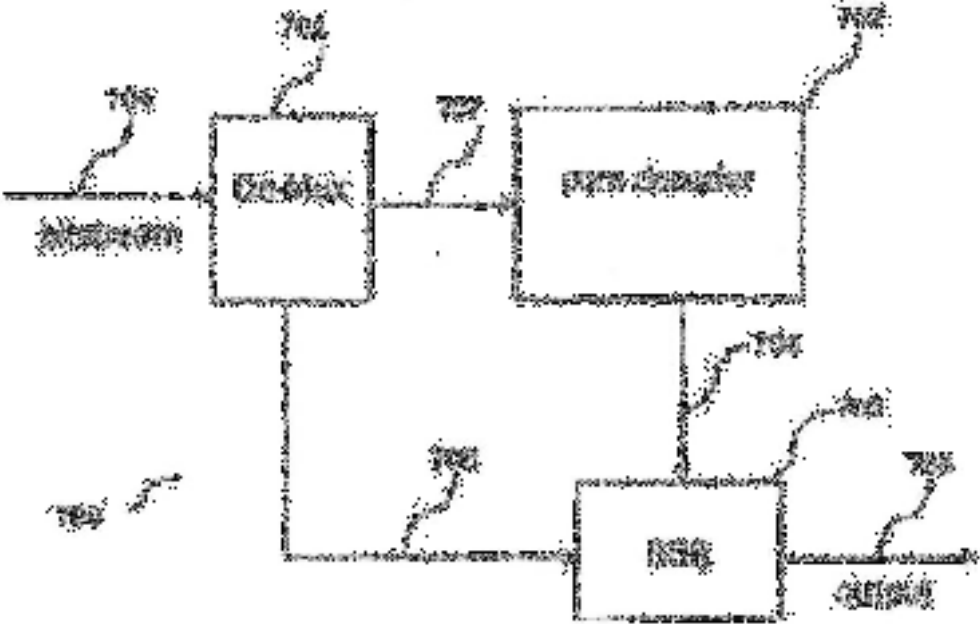

FIG. 7

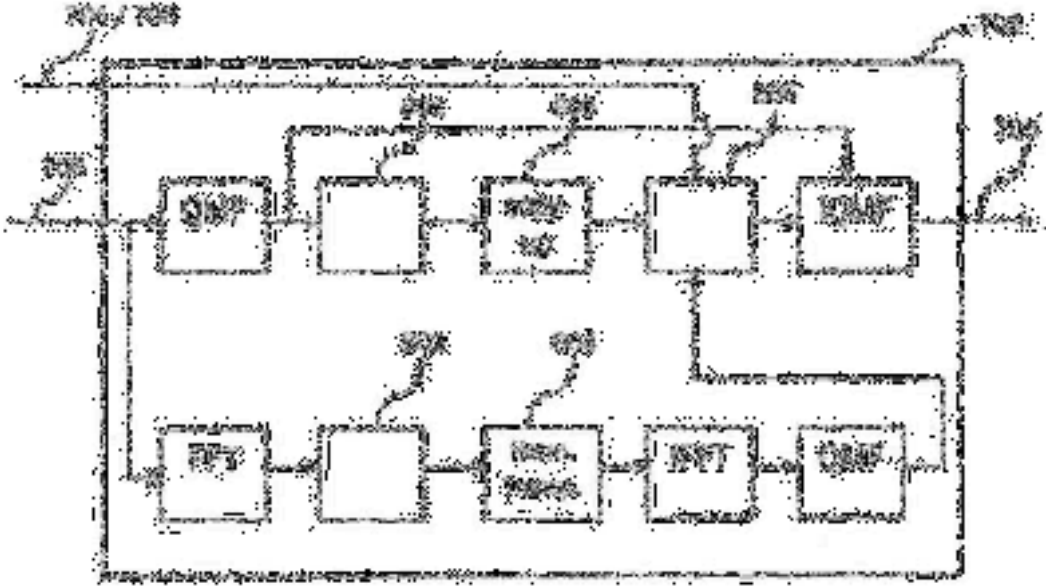

FIG. 8

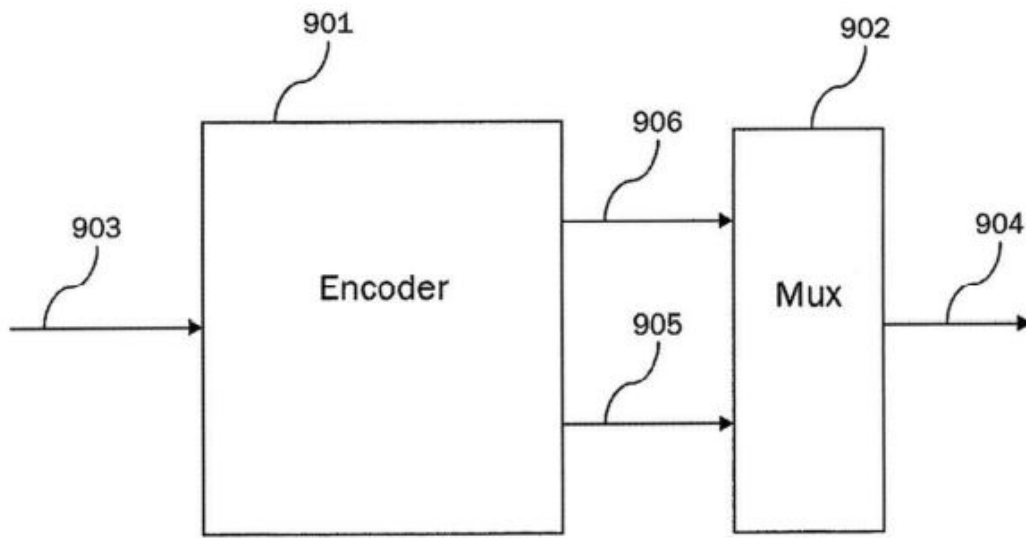

Fig. 9

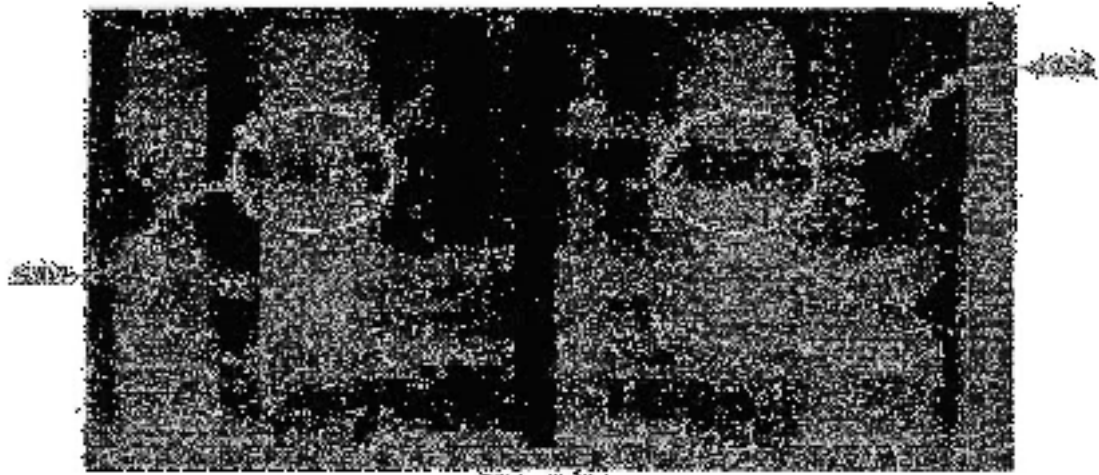

Fig. 10

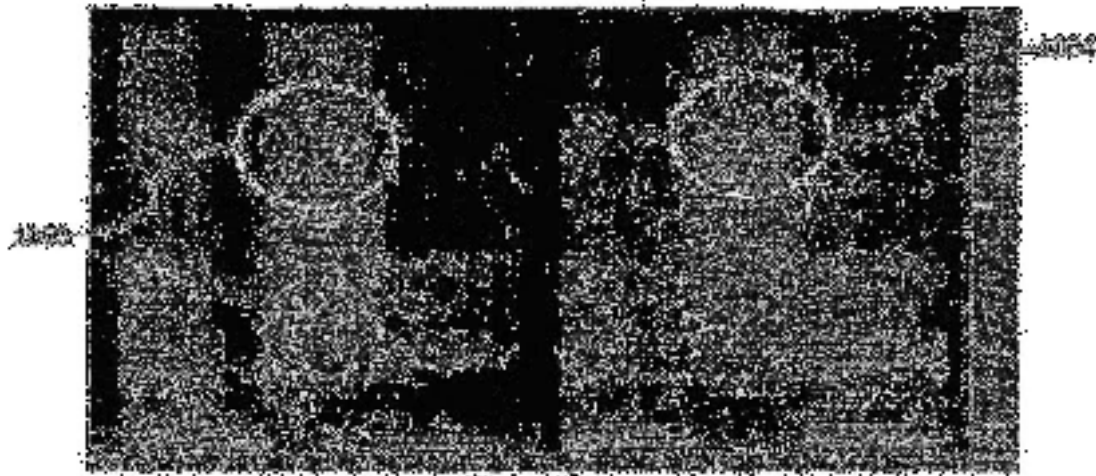

Fig. 11



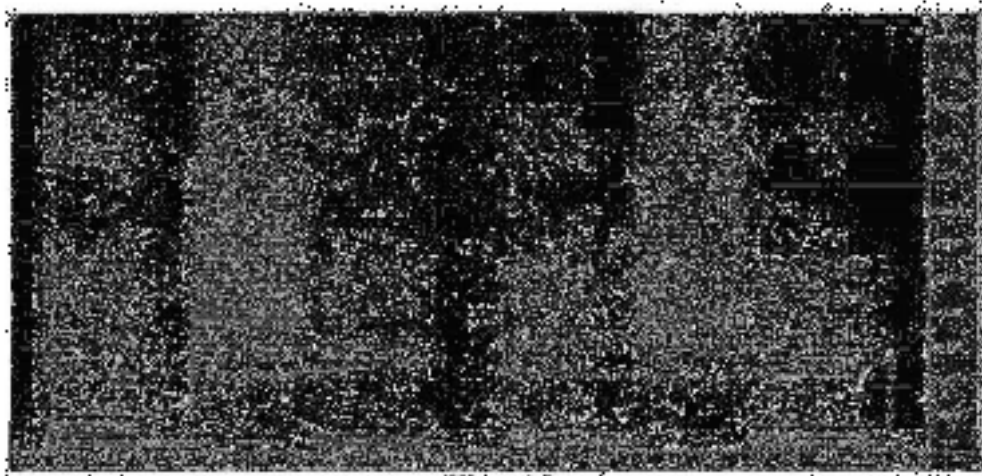

Fig. 104

Official Gazette of Industrial Property Vol. 274, 24/10/2024

- (11) No. 877
- (21) PA 877
- (22) 09/12/2022
- (30)
- (43)
- (51) Int.Cl.2018.01G 10L 19/02(2013.01), G 10L 19/022(2013.01), G 10L 25/18(2013.01), G 10L 21/04(2013.01), G 10L 19/032(2013.01)
- (54) IMPROVED SUBBAND BLOCK BASED HARMONIC TRANSPOSITION
- (57) The present document relates to audio source coding systems which make use of a harmonic transposition method for high frequency reconstruction (HFR), as well as to digital effect processors, e.g. exciters, where generation of harmonic distortion add brightness to the processed signal, and to time stretchers where a signal duration is prolonged with maintained spectral content. A system and method configured to generate a time stretched and/or frequency transposed signal from an input signal is described' The system comprises an analysis filterbank (101) configured to provide an analysis subband signal from the input signal; wherein the analysis subband signal comprises a plurality of complex valued analysis samples, each having a phase and a magnitude' Furthermore' the system comprises a subband processing unit (102) configured to determine a synthesis subband signal from the analysis subband signal using a subband transposition factor Q and a subband stretch factor S . The subband processing unit (102) performs a block based nonlinear processing wherein the magnitude of samples of the synthesis subband signal are determined from the magnitude of corresponding samples of the analysis subband signal and a predetermined sample of the analysis subband signal. In addition, the system comprises a synthesis filterbank (103) configured to generate the time stretched and/or frequency transposed signal from the synthesis subband signal.
- (71) Dolby International AB Mr. Treublaan 7 1097DP Amsterdam The Netherlands, The Netherlands.
- (72) VILLEMoes, Lars - Danish.
- (74) ACTIP (LAO) IP CO, LTD..
- (55)

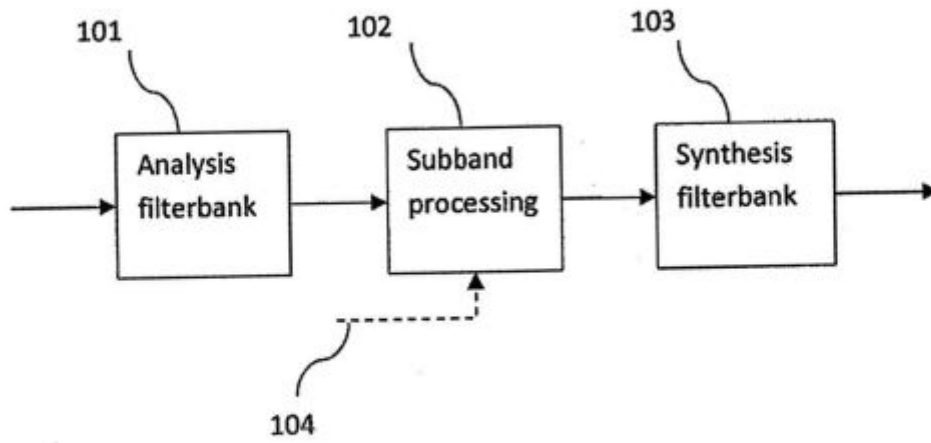

Fig. 1

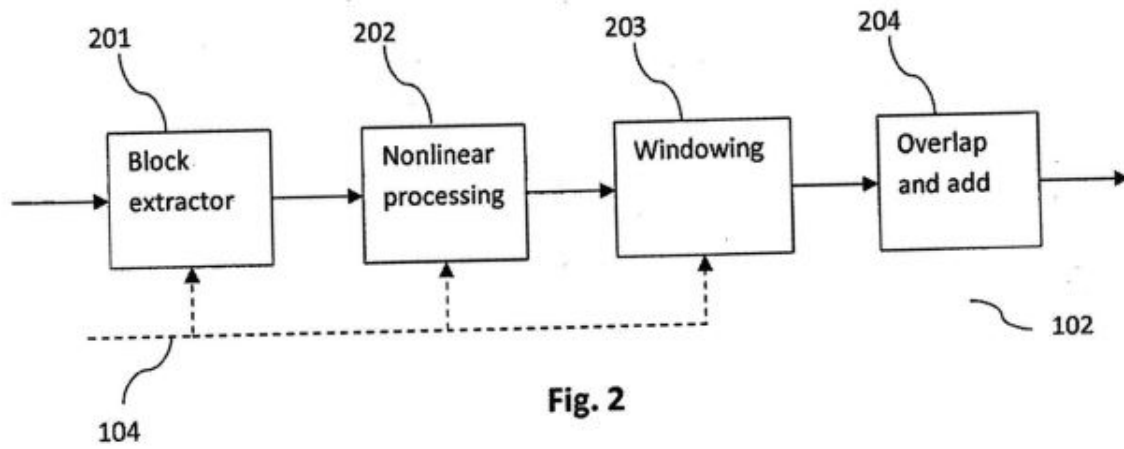

Fig. 2

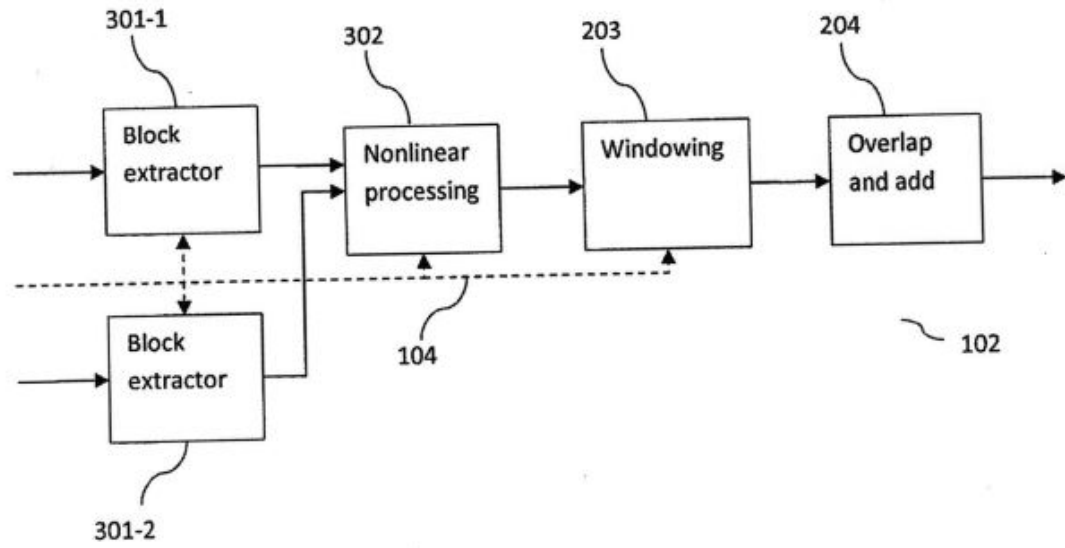
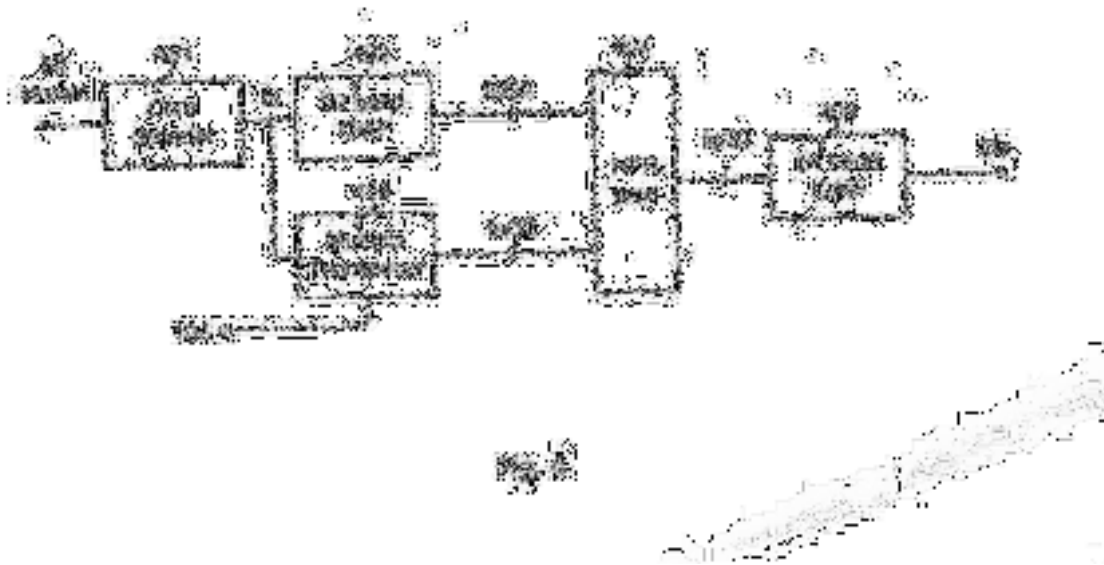

Fig. 3



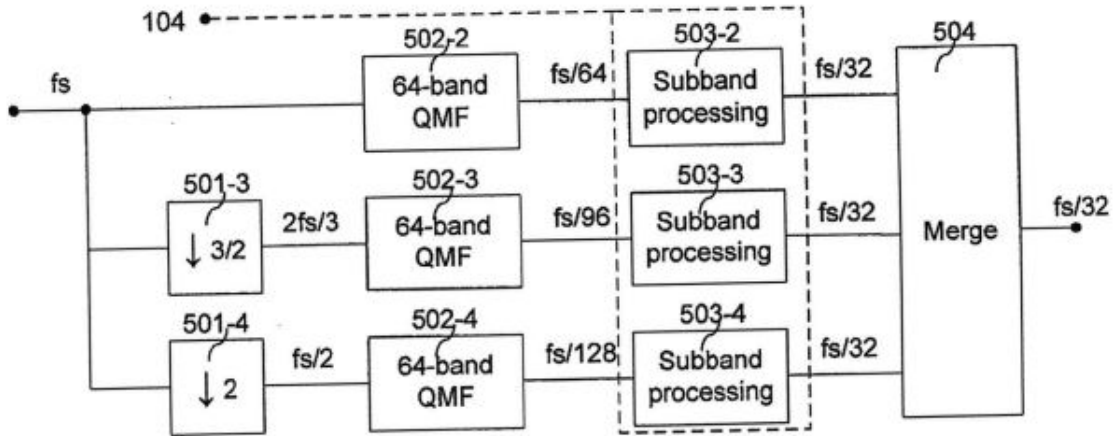
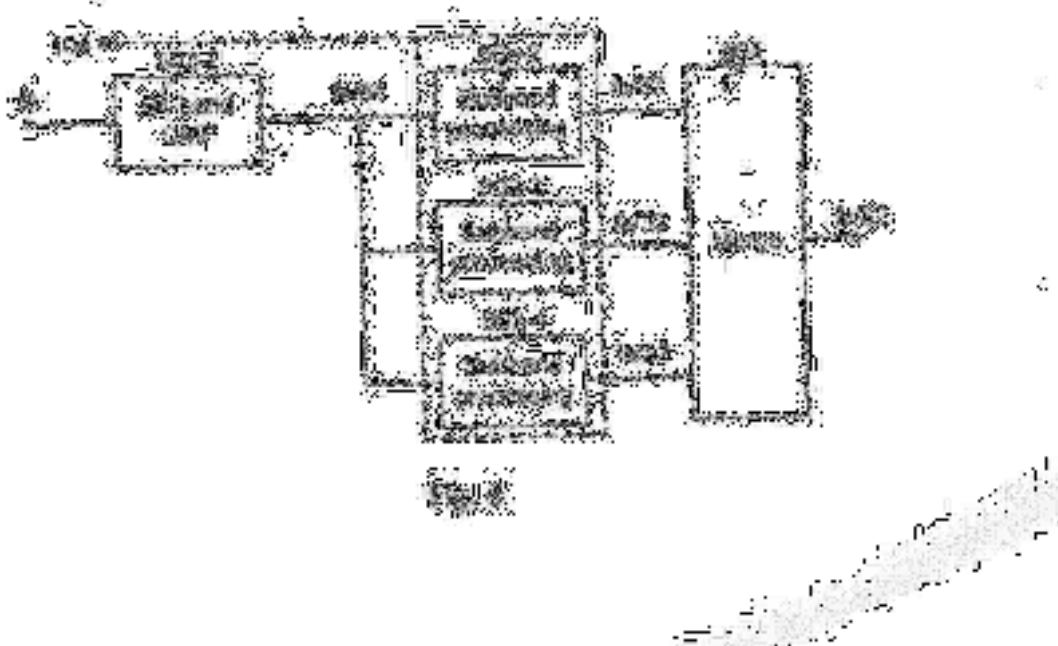

Fig. 5



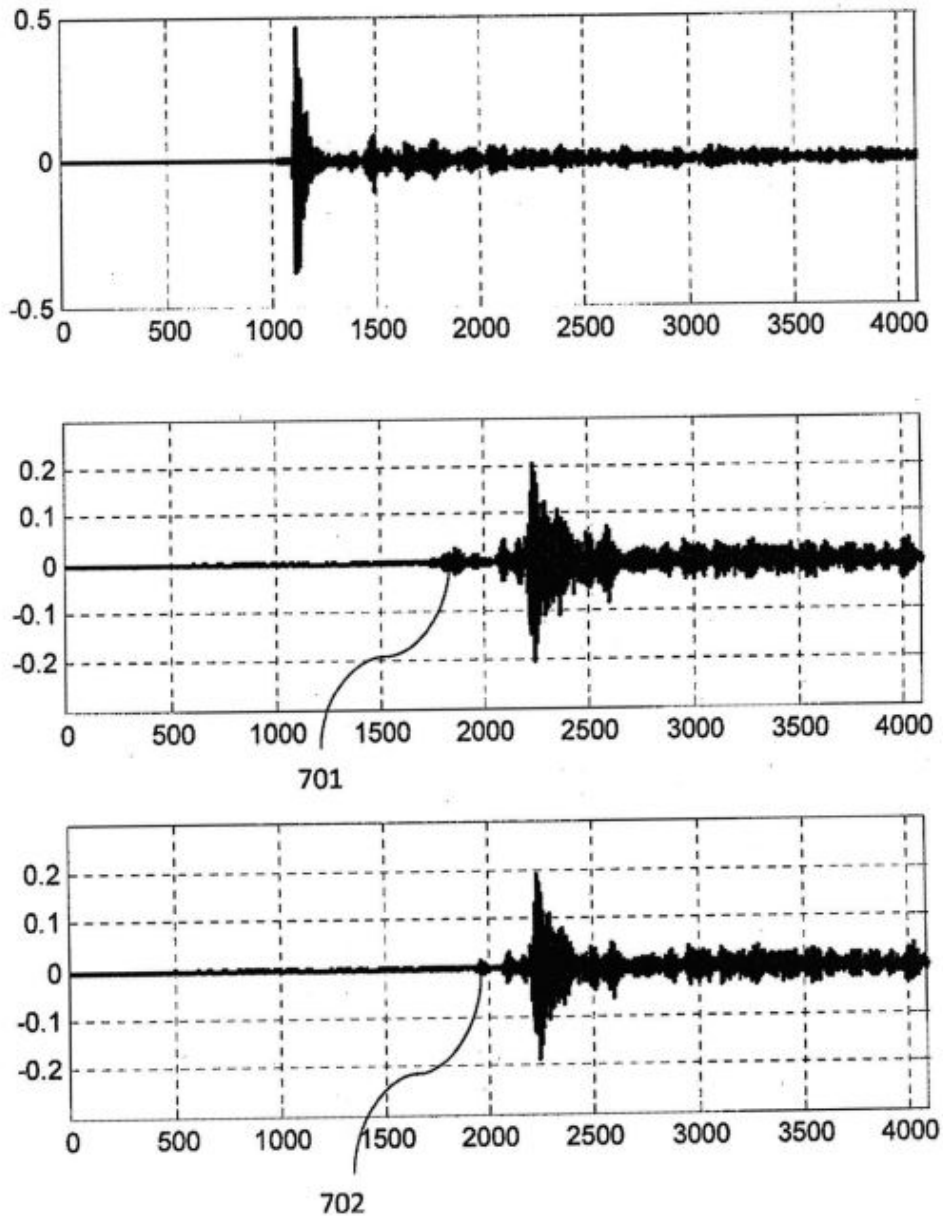

Fig. 7

Official Gazette of Industrial Property Vol. 274, 24/10/2024

- 11) No. 931  
(21) PA 931  
(22) 14/11/2023  
(30) 11202103196U 25/09/2019 SG  
(43)  
(51) Int.Cl.2018.01H 02H 1/00(2006.01), H 02J 13/00(2006.01), G 08B 19/00(2006.01)  
(54) ລະບົບການຕິດຕາມກວດກາໜັ້ແປງອັດສະລິຍະ  
(57) ລະບົບຕິດຕາມກວດກາໜັ້ແປງອັດສະລິຍະເພື່ອກວດຫາ ແລະ ຕິດຕາມກວດກາຫາຄວາມຜິດພາດແບບສຸ່ມ ໃນໜັ້ແປງໄຟຟ້າ ເນື່ອງຈາກການນໍາໃຊ້ບໍ່ຖືກຕ້ອງ ແລະ ການບໍາລຸງຮັກສາບໍ່ດີ. ລະບົບຕິດຕາມກວດກາໜັ້ແປງ ອັດສະລິຍະປະກອບມີ GSM-GPRS, ໂມດູນການວັດແທກ ແລະ ເຄື່ອງມື, ໂມດູນການຄວບຄຸມສະວິກໄຟຟ້າ, ການວັດແທກພະລັງງານ Trivector, ແລະ ໂມດູນ GPS. GSM-GPRS ປະກອບມີລະບົບຄວບຄຸມ ຂະໜາດນ້ອຍພ້ອມກັບໂມເດັມ csM-GpRS ເພື່ອເປີດໃຊ້ການສື່ສານທາງໄກ GSM-GpRS. ໂມດູນການ ວັດແທກ ແລະ ເຄື່ອງມືປະກອບມີສືບເອັດຊ່ອງທາງການວັດແທກອຸນຫະພູມທີມີ 8 ເຊັ່ນເຊື່ອນຫະພູມດິຈິຕອນ ແລະ 3-RTD. ໂມດູນຄວບຄຸມສະວິກໄຟຟ້າປະກອບມີ 4 SPDT ສະວິກເພື່ອຈັດການຄວບຄຸມຜົນຜະລິດເຊັ່ນ: ການເດີນທາງການໂຫຼດ ແລະ ມໍເຕີເຢັນ ແລະ ອື່ນໆ. ໂມດູນ GpS ໄດ້ຮັບຂໍ້ມູນເສັ້ນຂະໜານ, ເສັ້ນແວງ ແລະ ຂໍ້ມູນເວລາຈາກດາວທຽມ ເພື່ອແປງປັນກໍານົດທີ່ຕັ້ງ. ໂມດູນການໜອງພະລັງງານແມ່ນການສະໜອງພະລັງ ງານ AC / DC SMPS ເພື່ອປ່ຽນ 240V / 415V AC ເປັນ12 VDC ສໍາລັບລະບົບຕິດຕາມກວດກາໜັ້ແປງ ອັດສະລິຍະ.  
(71) ISCIENTIFIC TECHSOLUTIONS LABS PRIVATE LIMITED  
NO. 165, 2ND CROSS, 1ST MAIN, ISRO LAYOUT, JP NAGAR, BANGALORE,  
KARNATAKA, INDIA, 560111, INDIA.  
(72) RAOK, NARASIMHA.  
(74) HAVIP (LAOS) INTELLECTUAL PROPERTY LAW SOLE CO., LTD.  
(55)

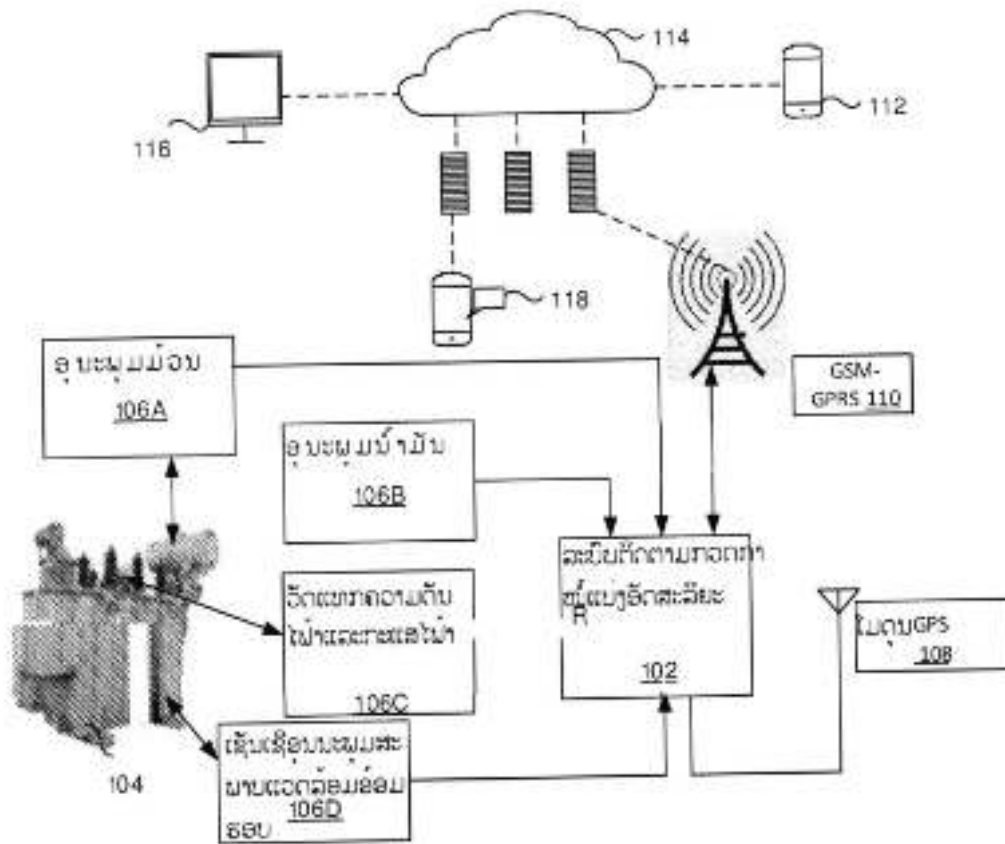

FIG.1



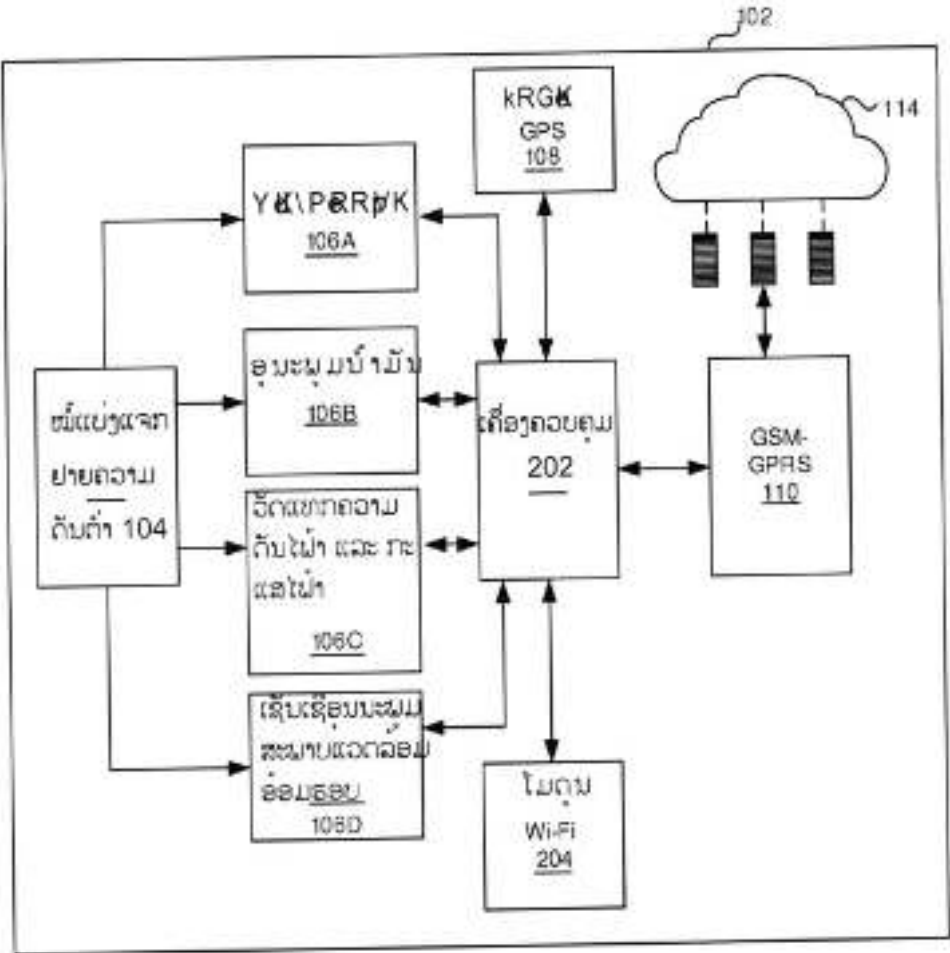

FIG. 2

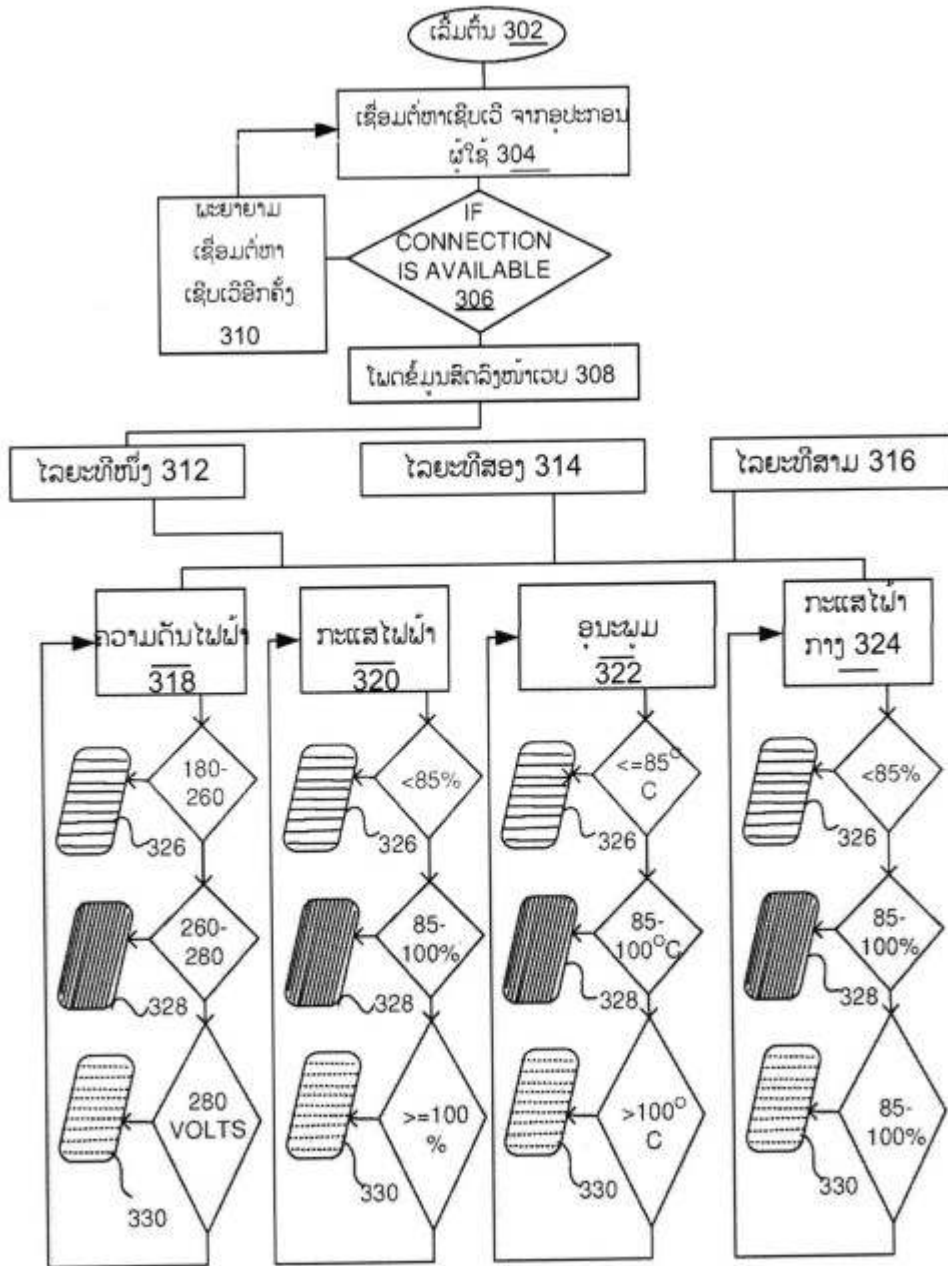

FIG. 3

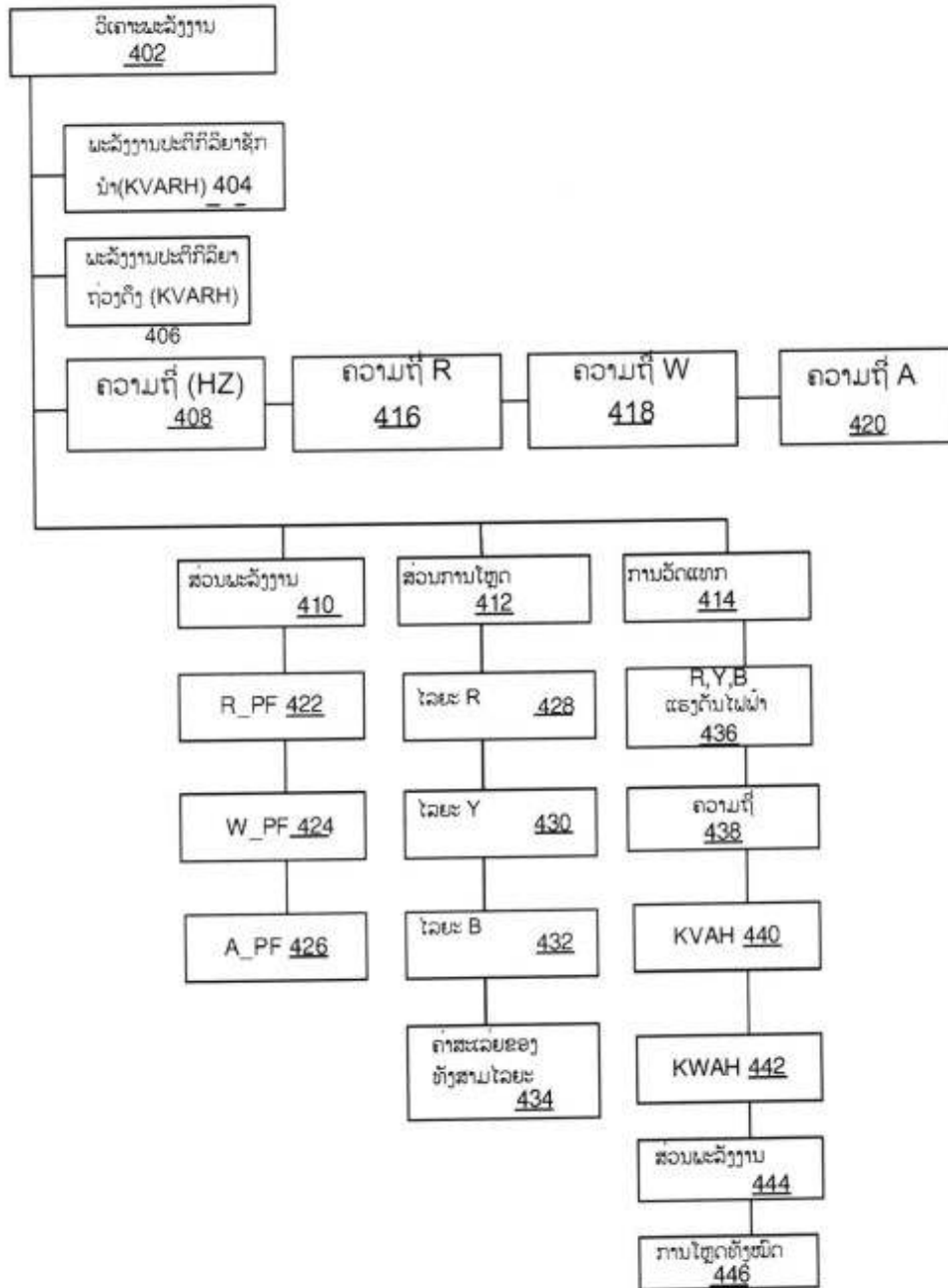

FIG.4

**ພາກທີ I**

**(Part I)**

**ສິດທິບັດ ແລະ ອະນຸສິດທິບັດ**

**(Patent and Petty Patent)**

**3. ການປ່ຽນແປງ**

**(Changes)**

**ພາກທີ I**

**(Part I)**

**ສິດທິບັດ ແລະ ອະນຸສິດທິບັດ**

**(Patent and Petty Patent)**

**4. ການດັດແກ້**

**(Amendments)**

ພາກທີ II  
(Part II)  
ແບບອຸດສາຫະກຳ  
(Industrial Design)

1. ຄຳຮ້ອງ  
(Applications)

ຄຳອະທິບາຍກ່ຽວກັບລະຫັດຫຍໍ້  
(Introduction of Codes)

- (21) ເລກທີ ຄຳຮ້ອງ (Filing Number)  
(22) ວັນທີ ຄຳຮ້ອງ (Filing Date)  
(30) ວັນທີ ບຸລິມາສິດ (Priority Date)  
(51) ໝວດ (Locarno Classification)  
(54) ຊື່ຂອງແບບອຸດສາຫະກຳ (Title)  
(71) ຊື່ ແລະ ທີ່ຢູ່ ຂອງເຈົ້າຂອງ (Owner Name and Address)  
(72) ຊື່ຜູ້ອອກແບບ (Designer Name)  
(74) ຊື່ຕົວແທນ (Representative Name)  
(55) ຮູບພາບ (Pictures)

ພາກທີ II  
(Part II)  
ແບບອຸດສາຫະກຳ  
(Industrial Design)

2. ຜົນການຈົດທະບຽນ  
(Registration)

ຄຳອະທິບາຍກ່ຽວກັບລະຫັດຫຍໍ້  
(Introduction of Codes)

- (11) ເລກທີ ຈົດທະບຽນ (Registration Number)  
(15) ວັນທີ ຈົດທະບຽນ (Registration Date)  
(21) ເລກທີ ຍືນຄຳຮ້ອງ (Filing Number)  
(22) ວັນທີ ຍືນຄຳຮ້ອງ (Filing Date)  
(30) ວັນທີ ບຸລິມາສິດ (Priority Date)  
(17) ວັນທີ ໝົດອາຍຸ (Expiration Date)  
(51) ໝວດ (Locarno Classification)  
(54) ຊື່ຂອງແບບອຸດສາຫະກຳ (Title)  
(71) ຊື່ ແລະ ທີ່ຢູ່ ຂອງເຈົ້າຂອງ (Owner Name and Address)  
(72) ຊື່ຜູ້ອອກແບບ (Designer Name)  
(74) ຊື່ຕົວແທນ (Representative Name)  
(55) ຮູບພາບ (Pictures)

**ພາກທີ II**

**(Part II)**

**ແບບອຸດສາຫະກຳ**

**(Industrial Design)**

**3. ການປ່ຽນແປງ**

**(Changes)**



**ພາກທີ II**

**(Part II)**

**ແບບອຸດສາຫະກຳ**

**(Industrial Design)**

**4. ການດັດແກ້**

**(Amendments)**

ພາກທີ III  
(Part III)  
ເຄື່ອງໝາຍການຄ້າ  
Trademarks

1. ຄໍາຮ້ອງ  
(Applications)

ຄໍາອະທິບາຍກ່ຽວກັບລະຫັດຫຍໍ້  
(Introduction of Codes)

- (540) ເຄື່ອງໝາຍການຄ້າ (Trademark)
- (511) ໝວດ (Nice Classification)
- (210) ເລກທີ ຄໍາຮ້ອງ (Number of the application)
- (220) ວັນທີ ຄໍາຮ້ອງ (Date of filing of the application)
- (732) ຊື່ ແລະ ທີ່ຢູ່ ຂອງຜູ້ຍື່ນຄໍາຮ້ອງ (Name and Address of applicant)

(540) Trademark Application



(511) 09 and 42

(210) No. 46900

(220) 12/04/2022

(732) SAIC-GM-WULING AUTOMOBILE CO.,  
LTD.

No.18, Hexi Road, Liunan District, Liuzhou,  
Guangxi, China

(540) Trademark Application



(511) 09 and 42

(210) No. 46901

(220) 12/04/2022

(732) SAIC-GM-WULING AUTOMOBILE CO.,  
LTD.

No.18, Hexi Road, Liunan District, Liuzhou,  
Guangxi, China

(540) Trademark Application



(511) 09 and 42

(210) No. 46902

(220) 12/04/2022

(732) SAIC-GM-WULING AUTOMOBILE CO.,  
LTD.

No.18, Hexi Road, Liunan District, Liuzhou,  
Guangxi, China

(540) Trademark Application

(511) 09 and 42

(210) No. 46903

(220) 12/04/2022

(732) SAIC-GM-WULING AUTOMOBILE CO.,  
LTD.

No.18, Hexi Road, Liunan District, Liuzhou,  
Guangxi, China

(540) Trademark Application

**BAOJUN**

(511) 09 and 42

(210) No. 46904

(220) 12/04/2022

(732) SAIC-GM-WULING AUTOMOBILE CO.,  
LTD.

No.18, Hexi Road, Liunan District, Liuzhou,  
Guangxi, China

(540) Trademark Application



(511) 09 and 42

(210) No. 46905

(220) 12/04/2022

(732) SAIC-GM-WULING AUTOMOBILE CO.,  
LTD.

No.18, Hexi Road, Liunan District, Liuzhou,  
Guangxi, China

(540) Trademark Application



(511) 09, 12, 37 and 42

(210) No. 46906

(220) 12/04/2022

(732) SAIC-GM-WULING AUTOMOBILE CO.,  
LTD.

No.18, Hexi Road, Liunan District, Liuzhou,  
Guangxi, China

(540) Trademark Application

**slanmol**

(511) 05

(210) No. 46918

(220) 20/04/2022

(732) Henan Yuzhixing Crop Protection Limited  
Mengzhou Industrial Cluster, Henan  
Province, China

(540) Trademark Application

**RONNEFELDT**

(511) 16

(210) No. 47027

(220) 24/05/2022

(732) J.T. Ronnefeldt KG

Jan-Weber-StraBe 2, 27726 Worpswede,  
Germany.

(540) Trademark Application

**RONNEFELDT**

(511) 21

(210) No. 47028

(220) 24/05/2022

(732) J.T. Ronnefeldt KG

Jan-Weber-StraBe 2, 27726 Worpswede,  
Germany.

(540) Trademark Application

**RONNEFELDT**

(511) 30

(210) No. 47029

(220) 24/05/2022

(732) J.T. Ronnefeldt KG

Jan-Weber-StraBe 2, 27726 Worpswede,  
Germany.

(540) Trademark Application



(511) 09, 16, 25, 30 and 43

(210) No. 47049

(220) 31/05/2022

(732) LOTTE GRS CO., LTD.

LOTTEGRS 10F, 104, beotkkot-ro,  
Geumcheon-gu, Seoul, Republic of Korea.



(540) Trademark Application



(511) 09, 16, 25, 30 and 43

(210) No. 47050

(220) 31/05/2022

(732) LOTTE GRS CO., LTD.

LOTTEGRS 10F, 104, beotkkot-ro,  
Geumcheon-gu, Seoul, Republic of Korea.

(540) Trademark Application



(511) 09, 16, 25, 30 and 43

(210) No. 47051

(220) 31/05/2022

(732) LOTTE GRS CO., LTD.

LOTTEGRS 10F, 104, beotkkot-ro,  
Geumcheon-gu, Seoul, Republic of Korea.

(540) Trademark Application



(511) 09, 16, 25, 30 and 43

(210) No. 47052

(220) 31/05/2022

(732) LOTTE GRS CO., LTD.

LOTTEGRS 10F, 104, beotkkot-ro,  
Geumcheon-gu, Seoul, Republic of Korea.

(540) Trademark Application



(511) 09, 16, 25, 30 and 43

(210) No. 47053

(220) 31/05/2022

(732) LOTTE GRS CO., LTD.

LOTTEGRS 10F, 104, beotkkot-ro,  
Geumcheon-gu, Seoul, Republic of Korea.

(540) Trademark Application

**Cafirate**

(511) 05

(210) No. 47137

(220) 23/06/2022

(732) Getz Pharma International FZ LLC

Office No. 1307, 13th Floor, Al-Thuraya  
Tower 1, Dubai Media City, Dubai, U.A.E,  
P.O. Box: 345018, Dubai,  
United Arab Emirates.

(540) Trademark Application

**Regasta**

(511) 05

(210) No. 47138

(220) 23/06/2022

(732) Getz Pharma International FZ LLC

Office No. 1307, 13th Floor, Al-Thuraya  
Tower 1, Dubai Media City, Dubai, U.A.E,  
P.O. Box: 345018, Dubai,  
United Arab Emirates.

(540) Trademark Application

**Ketroget**

(511) 05

(210) No. 47139

(220) 23/06/2022

(732) Getz Pharma International FZ LLC

Office No. 1307, 13th Floor, Al-Thuraya  
Tower 1, Dubai Media City, Dubai, U.A.E,  
P.O. Box: 345018, Dubai,  
United Arab Emirates.

(540) Trademark Application

**Nalbro**

(511) 05

(210) No. 47140

(220) 23/06/2022

(732) Getz Pharma International FZ LLC

Office No. 1307, 13th Floor, Al-Thuraya  
Tower 1, Dubai Media City, Dubai, U.A.E,  
P.O. Box: 345018, Dubai,  
United Arab Emirates.

(540) Trademark Application

**Oniteron**

(511) 05

(210) No. 47141

(220) 23/06/2022

(732) Getz Pharma International FZ LLC

Office No. 1307, 13th Floor, Al-Thuraya

Tower 1, Dubai Media City, Dubai, U.A.E,

P.O. Box: 345018, Dubai,

United Arab Emirates.

(540) Trademark Application



(511) 32

(210) No. 47562

(220) 24/10/2022

(732) PM 80 LTD.

111, Charat Mueang Road, Rong Mueang

Sub-district, Pathum Wan District,

Bangkok 10330, Thailand.

(540) Trademark Application

The logo consists of the word "LONGA" in a bold, stylized font. The letters are primarily orange with black outlines and shadows, giving it a 3D, blocky appearance.

(511) 32

(210) No. 47563

(220) 24/10/2022

(732) PM 80 LTD.

111, Charat Mueang Road, Rong Mueang  
Sub-district, Pathum Wan District,  
Bangkok 10330, Thailand.

(540) Trademark Application

The logo consists of the word "LONGA" in a bold, sans-serif font. The letters are a faded blue color.

(511) 32

(210) No. 47564

(220) 24/10/2022

(732) PM 80 LTD.

111, Charat Mueang Road, Rong Mueang  
Sub-district, Pathum Wan District,  
Bangkok 10330, Thailand.

(540) Trademark Application



(511) 03 and 05

(210) No. 47920

(220) 09/02/2023

(732) CAMELLIA (INTERNATIONAL) CO., LTD  
99/3 Soi Saimai 56, O Ngoen, Sai Mai,  
Bangkok 10220, Thailand.

(540) Trademark Application



(511) 06, 12 and 28

(210) No. 47934

(220) 10/02/2023

(732) ບໍລິສັດ ຜູ້ຈຽງ ການຄ້າ ຈຳກັດຜູ້ດຽວ  
ບ້ານ ໜອງຈັນ, ເມືອງ ສີສັດຕະນາກ,  
ນະຄອນຫຼວງວຽງຈັນ, ສປປ ລາວ

(540) Trademark Application

The logo for LERROS is the word "LERROS" in a bold, red, sans-serif font. The letters are slightly shadowed, giving it a 3D appearance as if it's floating above a white surface.

(511) 30

(210) No. 47945

(220) 16/02/2023

(732) LERROS INTERFOODS CO., LTD.

408/6 Moo 7, Bang Poo Mai, Mueang Samut  
Prakan, Samut Prakan, 10280, Thailand.

(540) Trademark Application



(511) 05

(210) No. 47946

(220) 16/02/2023

(732) Miss Patcharaporn Kitviriyakul

227/87 Moo 4, Cha Lok Ratt Road, Makham  
Tia, Mueang Surat Thani, Surat Thani 84000,  
Thailand.



(540) Trademark Application

**Aji-mayo**

(511) 30

(210) No. 48020

(220) 10/03/2023

(732) Ajinomoto Co., Inc.

15-1, Kyobashi 1-chome, Chuo-ku, Tokyo,  
Japan.

(540) Trademark Application

**Dreamy**  
milk

(511) 29

(210) No. 48027

(220) 13/03/2023

(732) PRESERVED FOOD SPECIALTY CO.,  
LTD.

14,16 Soi Rama 2, Soi 10, Chom Thong,  
Chom Thong, Bangkok 10150, Thailand.

(540) Trademark Application



(511) 29

(210) No. 48028

(220) 13/03/2023

(732) PRESERVED FOOD SPECIALTY CO.,  
LTD.

14,16 Soi Rama 2, Soi 10, Chom Thong,  
Chom Thong, Bangkok 10150, Thailand.

(540) Trademark Application

**RALLIART**

(511) 12

(210) No. 48054

(220) 15/03/2023

(732) MITSUBISHI JIDOSHA KOGYO  
KABUSHIKI KAISHA

1-21, Shibaura 3-chome, Minato-ku,  
Tokyo 108-8410, Japan.

(540) Trademark Application

The logo for RALLIART features the word "RALLI" in a bold, sans-serif font, followed by a stylized graphic of vertical lines of varying heights, and then the word "ART" in a bold, sans-serif font. The entire logo is contained within a black rectangular border.

(511) 12

(210) No. 48055

(220) 15/03/2023

(732) MITSUBISHI JIDOSHA KOGYO

KABUSHIKI KAISHA

1-21, Shibaura 3-chome, Minato-ku,

Tokyo 108-8410, Japan.

(540) Trademark Application

The logo for KOI consists of the word "KOI" in a bold, sans-serif font. The letters are black and have a slightly irregular, hand-drawn appearance.

(511) 30 and 35

(210) No. 48081

(220) 20/03/2023

(732) KOI CAFE GROUP (S) PTE. LTD.

2 SERANGOON NORTH AVENUE

5 #06-02, SINGAPORE 554911

(540) Trademark Application

The logo consists of the letters 'VDB' in a bold, blue, sans-serif font, followed by a vertical line, and then the word 'Loi' in a blue, cursive script font.

(511) 36, 41 and 45

(210) No. 48231

(220) 20/04/2023

(732) VDB Loi Co., Ltd

23 Singha Road, Nongbone Village,  
Saysettha District, Vientiane Cap,  
Lao People's Democratic Republic.

(540) Trademark Application

The logo features the word 'KOFEST' in a bold, black, sans-serif font. The letter 'O' is replaced by a stylized graphic of three horizontal bars in red, yellow, and blue.

(511) 11

(210) No. 48259

(220) 02/05/2023

(732) NGUYEN KHAC TUAN NAM

Gia Hamlet. Yen Dong Commune. Yen Lac  
District. Vinh Phuc Province., Vietnam.

(540) Trademark Application



(511) 36

(210) No. 48307

(220) 11/05/2023

(732) ທະນາຄານການຄ້າຕ່າງປະເທດລາວ ມະຫາຊື່ນ  
ເລກທີ 01, ຖະໜົນ: ປາງຄໍາ, ເມືອງຈັນທະບູລີ,  
ນະຄອນຫຼວງວຽງຈັນ, ສປປ ລາວ

(540) Trademark Application

**NUTRIXTRACT**

(511) 29, 30 and 32

(210) No. 48309

(220) 11/05/2023

(732) Fraser and Neave, Limited  
438 Alexandra Road, #20-00 Alexandra  
Point, Singapore 119958

(540) Trademark Application

**BENCH/ BODY SWIM**

(511) 03, 18, 25 and 35

(210) No. 48310

(220) 11/05/2023

(732) SUYEN Corporation

2214 Tolentino Street, Pasay City,  
Metro Manila, Philippines

(540) Trademark Application

**BENCH/ SWIM**

(511) 03, 18, 25 and 35

(210) No. 48311

(220) 11/05/2023

(732) SUYEN Corporation

2214 Tolentino Street, Pasay City,  
Metro Manila, Philippines.

(540) Trademark Application

**BENCH/ SWIMWEAR**

(511) 03, 18, 25 and 35

(210) No. 48312

(220) 11/05/2023

(732) SUYEN Corporation

2214 Tolentino Street, Pasay City,  
Metro Manila, Philippines.

(540) Trademark Application

**TOPSTAR**

(511) 25

(210) No. 48315

(220) 12/05/2023

(732) WENZHOU JOYOU SHOES CO., LIMITED

NO.8, WEIER ROAD, NANBIN STREET,  
RUIAN, ZHEJIANG, CHINA.

(540) Trademark Application



(511) 34

(210) No. 48316

(220) 12/05/2023

(732) SHENZHEN HEZHIDAO TECHNOLOGY  
CO., LTD

1001, Tongfang Central Building,  
Intersection of Xiner Community Center  
Road and Haoxiang Road, Xinqiao Street,  
Bao 'an District, Shenzhen, China.

(540) Trademark Application



(511) 05

(210) No. 48318

(220) 15/05/2023

(732) GlaxoSmithKline Consumer Healthcare  
Holdings (US) LLC

Corporation Service Company, 251 Little  
Falls Drive, Wilmington, Delaware 19808,  
United States of America.



(540) Trademark Application



西小串  
XI XIAO CHUAN

(511) 43

(210) No. 48320

(220) 15/05/2023

(732) Chongqing Shenghuobao Catering

Management Co., Ltd.

9-2, No.1, Haitong Road, Nan'an District,

Chongqing, China.

(540) Trademark Application



MYHO

(511) 03

(210) No. 48321

(220) 15/05/2023

(732) Yiwu Qizi Cosmetics Co., Ltd.

301, Unit4, Building 22, Jiuzhou Third

District, Houzhai Street, Yiwu City, Jinhua

Cig, Zheliang Province, China.

(540) Trademark Application



(511) 19

(210) No. 48322

(220) 15/05/2023

(732) ບໍລິສັດຊີມັງສາກົນຫົວພັນລາວ-ຈີນ ອາງຊີ ຈຳກັດ  
ບ້ານກ້າງທາດ, ເມືອງວຽງໄຊ, ແຂວງຫົວພັນ ສປປລາວ

(540) Trademark Application



(511) 28

(210) No. 48356

(220) 22/05/2023

(732) Guangdong Sembo Culture Industry Co., Ltd.  
Tangxia Nanhan Garden, Xiachen Village,  
Shanghua Town, Chenghai District, Shantou  
City, Guangdong, China.

(540) Trademark Application



(511) 35, 39 and 43

(210) No. 48360

(220) 23/05/2023

(732) ບໍລິສັດ ມິ່ງຕ້າ ທ່ອງທ່ຽວ ລາວຈຳກັດ  
ບ້ານທາດຫຼວງເໜືອ, ເມືອງ ໄຊເສດຖາ,  
ນະຄອນຫຼວງວຽງຈັນ, ສປປ ລາວ

(540) Trademark Application



(511) 05

(210) No. 48401

(220) 31/05/2023

(732) HANGZHOU HAOYUE PERSONAL CARE  
CO., LTD.  
N0.655 HONGFENG ROAD, YUHANG  
ECONOMIC AND TECHNOLOGICAL  
DEVELOPMENT ZONE, HANGZHOU  
CITY, ZHEJIANG PROVINCE, CHINA

(540) Trademark Application

SUNBRELLA

(511) 03

(210) No. 48402

(220) 31/05/2023

(732) HEBE BEAUTY PTE. LTD.

10 Anson Road #27-18 International Plaza  
Singapore (079903)

(540) Trademark Application



(511) 35

(210) No. 48437

(220) 07/06/2023

(732) LONG HONG INVESTMENT (LAO) SOLE  
CO.,LTD

Naxay Village, Saysettha District, Vientiane  
Capital, Lao People's Democratic Republic.

(540) Trademark Application

KAIKUANMEN

(511) 34

(210) No. 48445

(220) 07/06/2023

(732) ບໍລິສັດ ຢາສຸບລາວສາກົນ ຈຳກັດ

ບ້ານ ໜອງຂອນ, ເມືອງ ໂພນໂຮງ, ແຂວງວຽງຈັນ,  
ສປປ ລາວ

(540) Trademark Application

COROLLA QUEST

(511) 12

(210) No. 48484

(220) 14/06/2023

(732) TOYOTA JIDOSHA KABUSHIKI KAISHA

(also trading as TOYOTA MOTOR  
CORPORATION)

1, Toyota-cho, Toyota-shi, Aichi-ken, Japan.

(540) Trademark Application



(511) 09 and 35

(210) No. 48495

(220) 19/06/2023

(732) SolarSpace Technology Co., Ltd.

29 Gaoxin Road, Economic and  
Technological Development Zone, Xuzhou  
City, Jiangsu Province China

(540) Trademark Application



(511) 34

(210) No. 48540

(220) 21/06/2023

(732) ໂຮງງານ ບຸງແຕ່ງຢາສູບກຸ່ມບໍລິສັດ ເຊີນເຢີ ຈຳກັດ

ບ້ານພຽງໄຊ, ເມືອງບຸນເໜືອ, ແຂວງຜົ້ງສາລີ,

ສປປ ລາວ

(540) Trademark Application

**NEMATRIS**

(511) 05

(210) No. 48553

(220) 26/06/2023

(732) Mylan Laboratories Limited

Plot No. 564/A/22, Road No.92, Jubilee  
Hills, Hyderabad - 500 034, India.

(540) Trademark Application

The logo for BCP Lubricants features a stylized 'B' symbol on the left, followed by the text 'BCP' in a bold, italicized font, and 'LUBRICANTS' in a smaller, bold font below it.

(511) 04

(210) No. 48599

(220) 06/07/2023

(732) Bangchak Corporation Public Company  
Limited

2098 M Tower Building, 8th Floor,  
Sukhumvit Road, Phra Khanong Tai, Phra  
Khanong, Bangkok 10260, Thailand.

(540) Trademark Application

**幸运咖**

(511) 35

(210) No. 48612

(220) 07/07/2023

(732) MIXUEBINGCHENG CO., LTD.

Room 16004, Block A, Hanhaibeijin Business  
Center, North 3rd Ring Wenhua Road, Jinshui  
District, Zhengzhou City, Henan Province,,  
China.

(540) Trademark Application

**AOTELE**

(511) 35

(210) No. 48628

(220) 11/07/2023

(732) CHENGDU OTTNO COMMERCIAL  
MANAGEMENT CO., LTD

Nos. 1001 And 1005, 10th Floor, No.  
1577, Middle Section Of Tianfu Avenue,  
Chengdu High-Tech Zone, China (Sichuan)  
Pilot Free Trade Zone, China.



(540) Trademark Application

The logo for VSEVENSON features the letters 'VSEVENSON' in a bold, sans-serif font. The 'V' is significantly larger and more stylized than the other letters, with a horizontal line through its middle. The 'E' is also stylized with a horizontal line through its middle. The remaining letters 'VENSON' are in a standard weight of the same font.

(511) 25

(210) No. 48775

(220) 02/08/2023

(732) CHEN FENG

Wei Town, Shiwang Town, Yangchun City,  
Guangdong Province, China.

(540) Trademark Application

The logo for NEWTSOLQT features the letters 'NEWTSOLQT' in a bold, sans-serif font. The text is enclosed within a horizontal oval shape formed by two curved lines, one above and one below the text.

(511) 07

(210) No. 48787

(220) 07/08/2023

(732) ZHEJIANG AOMA PUMP INDUSTRIAL  
CO., LTD.

Injection Molding Park of Daxi Town,  
Wenling City, 317500 , China.

(540) Trademark Application

***KEM TRÀNG TIỀN***

(511) 30 and 35

(210) No. 48823

(220) 16/08/2023

(732) TRANG TIEN ICECREAM JOINT STOCK  
COMPANY

No. 35 Trang Tien, Trang Tien Ward, Hoan  
Kiem District, Hanoi City, Vietnam.

(540) Trademark Application

**CONDOR**

(511) 28

(210) No. 48840

(220) 18/08/2023

(732) Shanghai Nanxin Printing Technology Co.,  
Ltd

Building B, No. 3760 Jiahang Road, Jiading  
District, Shanghai, China.

(540) Trademark Application



(511) 12 and 17

(210) No. 48852

(220) 21/08/2023

(732) ASHUKA TECHNOLOGIES SDN BHD  
998-999 Solok Perusahaan 3, Kawasan Miel,  
Prai Industrial Estate, 13600 Perai, Penang,  
Malaysia.

(540) Trademark Application



(511) 32

(210) No. 48858

(220) 23/08/2023

(732) ບໍລິສັດ ເບຍລາວ ຈຳກັດ  
ຫຼັກ 12, ຖະໜົນທ່າເດື່ອ, ເມືອງ ຫາດຊາຍຝອງ,  
ນະຄອນຫຼວງວຽງຈັນ, ສປປ ລາວ

(540) Trademark Application



(511) 32

(210) No. 48859

(220) 23/08/2023

(732) ບໍລິສັດ ເບຍລາວ ຈຳກັດ

ຫຼັກ 12, ຖະໜົນທ່າເດື້ອ, ເມືອງ ຫາດຊາຍຝອງ,  
ນະຄອນຫຼວງວຽງຈັນ, ສປປ ລາວ

(540) Trademark Application



(511) 32

(210) No. 48860

(220) 23/08/2023

(732) ບໍລິສັດ ເບຍລາວ ຈຳກັດ

ຫຼັກ 12, ຖະໜົນທ່າເດື້ອ, ເມືອງ ຫາດຊາຍຝອງ,  
ນະຄອນຫຼວງວຽງຈັນ, ສປປ ລາວ

(540) Trademark Application



(511) 32

(210) No. 48861

(220) 23/08/2023

(732) ບໍລິສັດ ເບຍລາວ ຈຳກັດ

ຫຼັກ 12, ຖະໜົນທ່າເດື້ອ, ເມືອງ ຫາດຊາຍຝອງ,  
ນະຄອນຫຼວງວຽງຈັນ, ສປປ ລາວ

(540) Trademark Application



(511) 34

(210) No. 48863

(220) 24/08/2023

(732) SHENZHEN FUMOT TECHNOLOGY CO.,  
LIMITED

A2907, Block A, Longguang Jiuzuan  
Business Center, Tenglong Road, Daling  
Community, Minzhi Street, Longhua District,  
Shenzhen City, China.

(540) Trademark Application

The logo consists of the word "XTUOSEN" in a bold, black, sans-serif font. The 'X' is slightly larger and more prominent than the other letters.

(511) 07, 08 and 09

(210) No. 48874

(220) 29/08/2023

(732) Li Lingling

No. 430, Matou Village, Wuqiang Town,  
Wuqiang County, Hengshui, Hebei, China.

(540) Trademark Application



(511) 12

(210) No. 48887

(220) 31/08/2023

(732) ບໍລິສັດ ອາຍເຫຍົາ ຂາອອກ-ຂາເຂົ້າ ຈຳກັດຜູ້ດຽວ  
ບ້ານ ຫ້ວຍຫົງ, ເມືອງ ຈັນທະບູລີ,  
ນະຄອນຫຼວງວຽງຈັນ, ສປປ ລາວ

(540) Trademark Application



(511) 43

(210) No. 48892

(220) 31/08/2023

(732) ວິສາຫະກິດ ສ່ວນບຸກຄົນ ຮ້ານ ປີ້ງເປັດດອນແດງ  
ບ້ານ ດອນແດງ ເມືອງ ຈັນທະບູລີ ແຂວງ  
ນະຄອນຫລວງວຽງຈັນ, ສປປ ລາວ

(540) Trademark Application



(511) 07 and 12

(210) No. 48934

(220) 12/09/2023

(732) VINI INDUSTRIAL CO., LTD.  
Jinlonghu Industry Region, Beibei District,  
Chongqing, China.

(540) Trademark Application

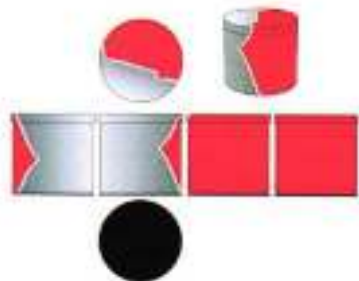

(511) 07

(210) No. 48935

(220) 12/09/2023

(732) VINI INDUSTRIAL CO., LTD.

Jinlonghu Industry Region, Beibei District,  
Chongqing, China.

(540) Trademark Application



(511) 31

(210) No. 49115

(220) 17/10/2023

(732) GAMBOL PET GROUP CO., LTD.

No. 8 Mudanjiang Rd., Economic and  
Technological Development zone, Liaocheng,  
shandong Province,, China.



(540) Trademark Application

**BALANCE  
NUTRITION**  
佰萃粮

(511) 31

(210) No. 49116

(220) 17/10/2023

(732) GAMBOL PET GROUP CO., LTD.

No. 8 Mudanjiang Rd., Economic and  
Technological Development zone, Liaocheng,  
shandong Province,, China.

(540) Trademark Application

**ONLEAD**

(511) 20

(210) No. 49117

(220) 17/10/2023

(732) ONLEAD GROUP CO., LTD.

Shuanghu Road No.121, Gaochun Economic  
Development Zone, Nanjing City, China.

(540) Trademark Application

PATAGONIA

(511) 18, 25 and 35

(210) No. 49120

(220) 17/10/2023

(732) Patagonia, Inc.

259 W. Santa Clara St., Ventura, California  
93001, United States of America.

(540) Trademark Application



(511) 18, 25 and 35

(210) No. 49121

(220) 17/10/2023

(732) Patagonia, Inc.

259 W. Santa Clara St., Ventura, California  
93001, United States of America.

(540) Trademark Application



(511) 05

(210) No. 49171

(220) 25/10/2023

(732) LIER CHEMICAL CO., LTD.

Economic & Technical Development Zone of  
Mianyang City, Sichuan Province, P.R,  
China.

(540) Trademark Application



(511) 07

(210) No. 49172

(220) 25/10/2023

(732) NINGBO JIDE ELECTRICAL APPLIANCE  
CO., LTD

Xidian Town, Ninghai County, Ningbo City,  
Zhejiang Province, China.

(540) Trademark Application

The logo consists of the word "MINIJ" in a bold, lowercase, sans-serif font. The letters are black and have a slightly irregular, hand-drawn appearance.

(511) 11

(210) No. 49173

(220) 25/10/2023

(732) NINGBO JIDE ELECTRICAL APPLIANCE  
CO., LTD

Xidian Town, Ninghai County, Ningbo City,  
Zhejiang Province, China.

(540) Trademark Application

The logo features the text "Tilleke & Gibbins" in a large, bold, serif font. The ampersand is stylized and positioned between the two names.

(511) 16, 35, 41, 42 and 45

(210) No. 49215

(220) 01/11/2023

(732) Tilleke & Gibbins International Ltd.

No. 1011, Supalai Grand Tower, 20th-26th  
Floor, Rama 3 Road, Chongnonsi  
Subdistrict, Yannawa District, 10120,  
Bangkok, Thailand.

(540) Trademark Application

**Tilleke  
& Gibbins**

(511) 16, 35, 41, 42 and 45

(210) No. 49215

(220) 01/11/2023

(732) Tilleke & Gibbins International Ltd.

No. 1011, Supalai Grand Tower, 20th-26th  
Floor, Rama 3 Road, Chongnonsi  
Subdistrict, Yannawa District, 10120,  
Bangkok, Thailand.

(540) Trademark Application

**KRYTOX**

(511) 04

(210) No. 49216

(220) 01/11/2023

(732) The Chemours Company FC, LLC

1007 Market Street, Wilmington, Delaware,  
19899, United States of America.

(540) Trademark Application

**KRYTOX**

(511) 04

(210) No. 49216

(220) 01/11/2023

(732) The Chemours Company FC, LLC

1007 Market Street, Wilmington, Delaware,  
19899, United States of America.

(540) Trademark Application



(511) 09, 11 and 37

(210) No. 49228

(220) 03/11/2023

(732) ວິສາຫະກິດສ່ວນບຸກຄົນ ຮ້ານ ໂອດຽນເຄື່ອງເຢັນ

ບ້ານ ຂົວຫຼວງ, ເມືອງ ຈັນທະບູລີ,  
ນະຄອນຫຼວງວຽງຈັນ, ສປປ ລາວ

(540) Trademark Application



(511) 09, 11 and 37

(210) No. 49228

(220) 03/11/2023

(732) ວິສາຫະກິດສ່ວນບຸກຄົນ ຮ້ານ ໂອດຽນເຄື່ອງເຢັນ  
ບ້ານ ຂົວຫຼວງ, ເມືອງ ຈັນທະບູລີ,  
ນະຄອນຫຼວງວຽງຈັນ, ສປປ ລາວ

(540) Trademark Application



(511) 09, 11 and 37

(210) No. 49229

(220) 03/11/2023

(732) ວິສາຫະກິດສ່ວນບຸກຄົນ ຮ້ານ ໂອດຽນເຄື່ອງເຢັນ  
ບ້ານ ຂົວຫຼວງ, ເມືອງ ຈັນທະບູລີ,  
ນະຄອນຫຼວງວຽງຈັນ, ສປປ ລາວ

(540) Trademark Application



(511) 09, 11 and 37

(210) No. 49229

(220) 03/11/2023

(732) ວິສາຫະກິດສ່ວນບຸກຄົນ ຮ້ານ ໂອດຽນເຄື່ອງເຢັນ  
ບ້ານ ຂົວຫຼວງ, ເມືອງ ຈັນທະບູລີ,  
ນະຄອນຫຼວງວຽງຈັນ, ສປປ ລາວ

(540) Trademark Application



(511) 05 and 31

(210) No. 49230

(220) 03/11/2023

(732) GREENFEED VIETNAM CORPORATION  
Nhut Chanh Commune, Ben Luc District,  
Long An Province, Vietnam.



(540) Trademark Application



(511) 05 and 31

(210) No. 49230

(220) 03/11/2023

(732) GREENFEED VIETNAM CORPORATION

Nhut Chanh Commune, Ben Luc District,  
Long An Province, Vietnam.

(540) Trademark Application



(511) 43

(210) No. 49232

(220) 06/11/2023

(732) GUANGZHOU SHENGFA CATERING

CO., LTD.

Room 103, No. 113, Changxing Road, Tianhe  
District, Guangzhou City, Guangdong  
Province, China.

(540) Trademark Application



(511) 43

(210) No. 49232

(220) 06/11/2023

(732) GUANGZHOU SHENGFA CATERING  
CO., LTD.

Room 103, No. 113, Changxing Road, Tianhe  
District, Guangzhou City, Guangdong  
Province, China.

(540) Trademark Application



(511) 06

(210) No. 49235

(220) 08/11/2023

(732) Dai Dung Metallic Manufacture Construction  
and Trade Corporation

Lot 38, Zone C, D1 Street, An Ha Industrial  
Park, Pham Van Hai Commune, Binh Chanh  
District, Ho Chi Minh City, Vietnam.

(540) Trademark Application



(511) 06

(210) No. 49235

(220) 08/11/2023

(732) Dai Dung Metallic Manufacture Construction  
and Trade Corporation

Lot 38, Zone C, D1 Street, An Ha Industrial  
Park, Pham Van Hai Commune, Binh Chanh  
District, Ho Chi Minh City, Vietnam.

(540) Trademark Application



(511) 09

(210) No. 49236

(220) 08/11/2023

(732) NGUYEN PHAN THANG

300/34/64 Nguyen Van Linh, Quarter 4, Binh  
Thuan Ward, District 7, Ho Chi Minh City,  
Vietnam.

(540) Trademark Application



(511) 09

(210) No. 49236

(220) 08/11/2023

(732) NGUYEN PHAN THANG

300/34/64 Nguyen Van Linh, Quarter 4, Binh Thuan Ward, District 7, Ho Chi Minh City, Vietnam.

(540) Trademark Application



(511) 09

(210) No. 49237

(220) 09/11/2023

(732) Mudan Qing

No.6, Zhongxing Group, Qingjia Committee, Dahetang Street Office, Shaodong County, Hunan Province, China.

(540) Trademark Application



(511) 33

(210) No. 49238

(220) 09/11/2023

(732) Beijing Shunxin Agriculture Co., Ltd.

Niulanshan Winery

East of Office, Niushan Area, Shunyi

District, Beijing, China.

(540) Trademark Application



(511) 07, 12 and 35

(210) No. 49240

(220) 09/11/2023

(732) Siam Kubota Corporation Co., Ltd.

101/19-24 Moo 20, Navanakorn Industrial

Estate, Klongneung sub-district, Klongluang

district, Pathumtani, Thailand.

(540) Trademark Application

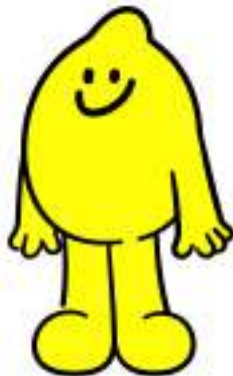

(511) 03, 09, 16, 18, 21, 25, 28, 35, 38, 41, 42 and 45

(210) No. 49242

(220) 09/11/2023

(732) Lemon Inc.

P.O. Box 31119 Grand Pavilion, Hibiscus Way, 802 West Bay Road, Grand Cayman, KY1-1205, Cayman Islands.

(540) Trademark Application



(511) 03, 09, 16, 18, 21, 25, 28, 35, 38, 41, 42 and 45

(210) No. 49242

(220) 09/11/2023

(732) Lemon Inc.

P.O. Box 31119 Grand Pavilion, Hibiscus Way, 802 West Bay Road, Grand Cayman, KY1-1205, Cayman Islands.

(540) Trademark Application



(511) 03, 09, 16, 18, 21, 25, 28, 35, 38, 41, 42 and 45

(210) No. 49243

(220) 09/11/2023

(732) Lemon Inc.

P.O. Box 31119 Grand Pavilion, Hibiscus Way, 802 West Bay Road, Grand Cayman, KY1-1205, Cayman Islands.

(540) Trademark Application



(511) 05 and 29

(210) No. 49246

(220) 10/11/2023

(732) Société des Produits Nestlé S.A.

1800 Vevey, Switzerland.

(540) Trademark Application



(511) 05 and 29

(210) No. 49247

(220) 10/11/2023

(732) Société des Produits Nestlé S.A.  
1800 Vevey, Switzerland.

(540) Trademark Application

**LACTOGROW**

(511) 05 and 29

(210) No. 49248

(220) 10/11/2023

(732) Société des Produits Nestlé S.A.  
1800 Vevey, Switzerland.



(540) Trademark Application

**KLONG**

(511) 07

(210) No. 49250

(220) 10/11/2023

(732) HANGZHOU KUAIZHUN AUTO PARTS

E-BUSINESS CO.,LTD

Room 1503-1504, Building 3, Haichuang  
Science and Technology Center, Cangqian  
Street, Yuhang District, Hangzhou City,  
Zhejiang Province, China.

(540) Trademark Application

**Kbase**

(511) 12 and 17

(210) No. 49252

(220) 10/11/2023

(732) HANGZHOU KUAIZHUN AUTO PARTS

E-BUSINESS CO.,LTD

Room 1503-1504, Building 3, Haichuang  
Science and Technology Center, Cangqian  
Street, Yuhang District, Hangzhou City,  
Zhejiang Province, China.

(540) Trademark Application

VIC EAGLE

(511) 04

(210) No. 49253

(220) 10/11/2023

(732) HANGZHOU KUAIZHUN AUTO PARTS

E-BUSINESS CO.,LTD

Room 1503-1504, Building 3, Haichuang  
Science and Technology Center, Cangqian  
Street, Yuhang District, Hangzhou City,  
Zhejiang Province, China.

(540) Trademark Application

Coburo

(511) 01

(210) No. 49254

(220) 10/11/2023

(732) HANGZHOU KUAIZHUN AUTO PARTS

E-BUSINESS CO.,LTD

Room 1503-1504, Building 3, Haichuang  
Science and Technology Center, Cangqian  
Street, Yuhang District, Hangzhou City,  
Zhejiang Province, China.

(540) Trademark Application

**Q-CLEAN P+**

(511) 12

(210) No. 49255

(220) 10/11/2023

(732) HANGZHOU KUAIZHUN AUTO PARTS

E-BUSINESS CO.,LTD

Room 1503-1504, Building 3, Haichuang  
Science and Technology Center, Cangqian  
Street, Yuhang District, Hangzhou City,  
Zhejiang Province, China.

(540) Trademark Application

**K-Leopard**

(511) 09

(210) No. 49256

(220) 10/11/2023

(732) HANGZHOU KUAIZHUN AUTO PARTS

E-BUSINESS CO.,LTD

Room 1503-1504, Building 3, Haichuang  
Science and Technology Center, Cangqian  
Street, Yuhang district, Hangzhou City,  
Zhejiang Province, China.

(540) Trademark Application

KZWON

(511) 07 and 12

(210) No. 49257

(220) 10/11/2023

(732) HANGZHOU KUAIZHUN AUTO PARTS

E-BUSINESS CO.,LTD

Room 1503-1504, Building 3, Haichuang  
Science and Technology Center, Cangqian  
Street, Yuhang District, Hangzhou City,  
Zhejiang Province, China.

(540) Trademark Application



(511) 09

(210) No. 49259

(220) 10/11/2023

(732) Gokin Solar Co., Ltd.

Unit B25, 2 / F, Building 4, 153 Rongao  
Road, Hengqin New District, Zhuhai City,  
Guangdong Province, 519000, China.

(540) Trademark Application

**MCPUFF**

(511) 34

(210) No. 49264

(220) 13/11/2023

(732) TAN KHER WEI

No. 65-2, 506, wanghai Road, Software Park  
2, Siming District, Xiamen City, Fujian  
Province 361000, China.

(540) Trademark Application

**smartdaili**

(511) 42

(210) No. 49265

(220) 13/11/2023

(732) SHANGHAI SHENG JUN INFORMATION  
TECHNOLOGY LTD.

58 Bu Zhen Nan Rd., Bu Zhen, Chong Ming  
Dist., Shanghai, China.

(540) Trademark Application

**smartdaili**

(511) 38

(210) No. 49266

(220) 13/11/2023

(732) SHANGHAI SHENG JUN INFORMATION  
TECHNOLOGY LTD.

58 Bu Zhen Nan Rd., Bu Zhen, Chong Ming  
Dist., Shanghai, China.

(540) Trademark Application

**smartdaili**

(511) 09

(210) No. 49267

(220) 13/11/2023

(732) SHANGHAI SHENG JUN INFORMATION  
TECHNOLOGY LTD.

58 Bu Zhen Nan Rd., Bu Zhen, Chong Ming  
Dist., Shanghai, China.

(540) Trademark Application

**UNLEASH THE  
BEAST!**

(511) 32

(210) No. 49271

(220) 14/11/2023

(732) Monster Energy Company

1 Monster Way, Corona, California 92879,  
United States of America.

(540) Trademark Application



Cây Tre

កាំបែ

Bamboo

(511) 30

(210) No. 49274

(220) 14/11/2023

(732) VIMAFLOUR LTD

Cai Lan Industrial Zone, Ha Long City,  
Quang Ninh Province, Vietnam.

(540) Trademark Application

The logo for 'Buldak' is written in a bold, red, stylized font with a white outline and a slight shadow effect, giving it a three-dimensional appearance.

(511) 29

(210) No. 49276

(220) 15/11/2023

(732) Samyang Foods Co., Ltd

104, Opaesan-ro 3-gil, Seongbuk-gu, Seoul,  
02737, Republic of Korea.

(540) Trademark Application



(511) 03, 05, 25, 30 and 35

(210) No. 49278

(220) 15/11/2023

(732) ທ່ານ ວັນໃໝ່ ທຳມະວິງ

ບ້ານ ໂພນສະຫວັນ, ນະຄອນໄກສອນພິມວິຫານ,  
ແຂວງ ສະຫວັນນະເຂດ, ສປປ ລາວ



(540) Trademark Application



(511) 03 and 21

(210) No. 49279

(220) 15/11/2023

(732) LION CORPORATION

1-3-28 Kuramae, Taito-ku, , 111-8644,  
Tokyo, Japan.

(540) Trademark Application



(511) 03 and 21

(210) No. 49280

(220) 15/11/2023

(732) LION CORPORATION

1-3-28 Kuramae, Taito-ku, , 111-8644,  
Tokyo ,Japan.

(540) Trademark Application

**茂隆酱园**  
*Maolung*

(511) 29 and 30

(210) No. 49303

(220) 17/11/2023

(732) MAOLUNG JIANGYUAN FOOD CO.,  
LTD.

No. 889, East Gaoming Avenue, Sanzhou,  
Hecheng, Gaoming, Foshan, Guangdong,  
China.

(540) Trademark Application

**VEDA TINDA**

(511) 03

(210) No. 49304

(220) 17/11/2023

(732) GUANGZHOU BENYUAN  
INFORMATION TECHNOLOGY CO.,  
LTD.

Room 409, Building 7, No. 63, Huangbian  
North Road, Baiyun District, Guangzhou,  
Guangdong, China.

(540) Trademark Application



(511) 35

(210) No. 49305

(220) 17/11/2023

(732) ITEL TECHNOLOGY LIMITED

Flat N, 16/F, Block B, Universal Industrial  
Centre, 19-25 Shan Mei Street, Fotan, NT,  
Hong Kong.

(540) Trademark Application

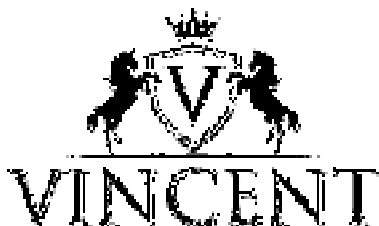

(511) 33

(210) No. 49306

(220) 17/11/2023

(732) PHOENIX SYNDICATE (THAILAND)  
COMPANY LIMITED

899/57 Soi Sukhumvit 101 Bang Chak, Phra  
Khanong, Bangkok 10260, Thailand.

(540) Trademark Application

**TOUS *les* JOURS**

(511) 09

(210) No. 49307

(220) 17/11/2023

(732) CJ FOODVILLE CORP.

34, Mareunnae-ro, Jung-gu, Seoul,  
Republic of Korea.

(540) Trademark Application

**TOUS *les* JOURS**

(511) 29

(210) No. 49308

(220) 17/11/2023

(732) CJ FOODVILLE CORP.

34, Mareunnae-ro, Jung-gu, Seoul,  
Republic of Korea.

(540) Trademark Application

**TOUS *les* JOURS**

(511) 30

(210) No. 49309

(220) 17/11/2023

(732) CJ FOODVILLE CORP.

34, Mareunnae-ro, Jung-gu, Seoul,  
Republic of Korea.

(540) Trademark Application

**TOUS *les* JOURS**

(511) 31

(210) No. 49310

(220) 17/11/2023

(732) CJ FOODVILLE CORP.

34, Mareunnae-ro, Jung-gu, Seoul,  
Republic of Korea.

(540) Trademark Application

**TOUS *les* JOURS**

(511) 35

(210) No. 49311

(220) 17/11/2023

(732) CJ FOODVILLE CORP.

34, Mareunnae-ro, Jung-gu, Seoul,  
Republic of Korea.

(540) Trademark Application

**TOUS *les* JOURS**

(511) 43

(210) No. 49312

(220) 17/11/2023

(732) CJ FOODVILLE CORP.

34, Mareunnae-ro, Jung-gu, Seoul,  
Republic of Korea.

(540) Trademark Application



(511) 09

(210) No. 49313

(220) 17/11/2023

(732) CJ FOODVILLE CORP.

34, Mareunnae-ro, Jung-gu, Seoul,  
Republic of Korea.

(540) Trademark Application



(511) 29

(210) No. 49314

(220) 17/11/2023

(732) CJ FOODVILLE CORP.

34, Mareunnae-ro, Jung-gu, Seoul,  
Republic of Korea.

(540) Trademark Application



(511) 30

(210) No. 49315

(220) 17/11/2023

(732) CJ FOODVILLE CORP.

34, Mareunnae-ro, Jung-gu, Seoul,  
Republic of Korea.

(540) Trademark Application



(511) 31

(210) No. 49316

(220) 17/11/2023

(732) CJ FOODVILLE CORP.

34, Mareunnae-ro, Jung-gu, Seoul,  
Republic of Korea.



(540) Trademark Application



(511) 35

(210) No. 49317

(220) 17/11/2023

(732) CJ FOODVILLE CORP.

34, Mareunnae-ro, Jung-gu, Seoul,  
Republic of Korea.

(540) Trademark Application



(511) 43

(210) No. 49318

(220) 17/11/2023

(732) CJ FOODVILLE CORP.

34, Mareunnae-ro, Jung-gu, Seoul,  
Republic of Korea.

(540) Trademark Application

**江边城外** **烤全鱼**  
RIVERSIDE GRILLED FISH

(511) 43

(210) No. 49319

(220) 20/11/2023

(732) Beijing Riverside & Courtyard Investment  
Management Co., Ltd.

Room 4061, 4/F Building 8 Weibohao Home,  
No.1 Weigongcun Street, Haidian district,  
Beijing, China.

(540) Trademark Application

**HOO**

(511) 09, 34 and 35

(210) No. 49322

(220) 20/11/2023

(732) SHANGHAI TOBACCO GROUP CO., LTD.

717 Chang Yang Road, Yangpu District,  
Shanghai, China.

(540) Trademark Application

**SWICH OH BOY**

(511) 30

(210) No. 49323

(220) 20/11/2023

(732) INTERNATIONAL FOODSTUFFS CO. LLC

Al-Wahda Street, Industrial Area No.1, P.O.

Box No.4115, Sharjah, United Arab Emirates.

(540) Trademark Application



(511) 06, 07, 09, 12, 14 and 16

(210) No. 49324

(220) 21/11/2023

(732) China Railway Kunming Group Co., Ltd.

No. 548, Tangshuang Road, Nanzhanxincun,

Kunming City, Yunnan Province, China.

(540) Trademark Application



(511) 33

(210) No. 49325

(220) 21/11/2023

(732) Guizhou Guijiu Co., Ltd.

Longchang Town, Xiuwen County, Guiyang  
City Guizhou Province, China.

(540) Trademark Application



(511) 33

(210) No. 49326

(220) 21/11/2023

(732) Guizhou Guijiu Co., Ltd.

Longchang Town, Xiuwen County, Guiyang  
City Guizhou Province, China.

(540) Trademark Application



(511) 18, 20, 21, 22, 25 and 35

(210) No. 49327

(220) 21/11/2023

(732) China Railway Kunming Group Co., Ltd.  
No. 548, Tangshuang Road, Nanzhanxincun,  
Kunming City, Yunnan Province, China.

(540) Trademark Application



(511) 36, 38, 39, 41, 42 and 45

(210) No. 49328

(220) 21/11/2023

(732) China Railway Kunming Group Co., Ltd.  
No. 548, Tangshuang Road, Nanzhanxincun,  
Kunming City, Yunnan Province, China.

(540) Trademark Application

麗瀾快綫

(511) 06, 07, 09, 12, 14 and 16

(210) No. 49329

(220) 21/11/2023

(732) China Railway Kunming Group Co., Ltd.  
No. 548, Tangshuang Road, Nanzhanxincun,  
Kunming City, Yunnan Province, China.

(540) Trademark Application

麗瀾快綫

(511) 18, 20, 21, 22, 25 and 35

(210) No. 49330

(220) 21/11/2023

(732) China Railway Kunming Group Co., Ltd.  
No. 548, Tangshuang Road, Nanzhanxincun,  
Kunming City, Yunnan Province, China.

(540) Trademark Application

麗瀾快綫

(511) 36, 38, 39, 41, 42 and 45

(210) No. 49331

(220) 21/11/2023

(732) China Railway Kunming Group Co., Ltd.  
No. 548, Tangshuang Road, Nanzhanxincun,  
Kunming City, Yunnan Province, China.

(540) Trademark Application

麗瀾快綫

(511) 06, 07, 09, 12, 14 and 16

(210) No. 49332

(220) 21/11/2023

(732) China Railway Kunming Group Co., Ltd.  
No. 548, Tangshuang Road, Nanzhanxincun,  
Kunming City, Yunnan Province, China.

(540) Trademark Application

昆明铁路局

(511) 18, 20, 21, 22, 25 and 35

(210) No. 49333

(220) 21/11/2023

(732) China Railway Kunming Group Co., Ltd.

No. 548, Tangshuang Road, Nanzhanxincun,  
Kunming City, Yunnan Province, China.

(540) Trademark Application

贵酒

(511) 33

(210) No. 49334

(220) 21/11/2023

(732) Guizhou Guijiu Co., Ltd.

Longchang Town, Xiuwen County, Guiyang  
City Guizhou Province, China.



(540) Trademark Application

**EXPRESS**

(511) 36, 38, 39, 41, 42 and 45

(210) No. 49335

(220) 21/11/2023

(732) China Railway Kunming Group Co., Ltd.  
No. 548, Tangshuang Road, Nanzhanxincun,  
Kunming City, Yunnan Province, China.

(540) Trademark Application

**GUIJIU**

(511) 33

(210) No. 49336

(220) 21/11/2023

(732) Guizhou Guijiu Co., Ltd.  
Longchang Town, Xiuwen County, Guiyang  
City Guizhou Province, China.

(540) Trademark Application

The logo for 'City Fresh' features the word 'City' in a bold, sans-serif font above the word 'Fresh' in a larger, bolder, sans-serif font. Both words are in black.

(511) 29, 30, 31 and 43

(210) No. 49337

(220) 21/11/2023

(732) CITY FRESH FRUIT CO., LTD.

8 Karnchanapisek Road, Klong Bangbon,  
Bangbon, Bangkok 10150, Thailand.

(540) Trademark Application

The logo for 'TOPTEN' features the word 'TOPTEN' in a bold, sans-serif font. The letter 'O' is stylized with a circular pattern, and the letter 'E' is also stylized with a circular pattern.

(511) 18

(210) No. 49340

(220) 22/11/2023

(732) SHINSUNG TONGSANG CO., LTD.

444 Dunchon-dong, Gangdong-ku, Seoul,  
Republic of Korea.

(540) Trademark Application



(511) 25

(210) No. 49341

(220) 22/11/2023

(732) SHINSUNG TONGSANG CO., LTD.

444 Dunchon-dong, Gangdong-ku, Seoul,  
Republic of Korea.

(540) Trademark Application



(511) 35

(210) No. 49342

(220) 22/11/2023

(732) SHINSUNG TONGSANG CO., LTD.

444 Dunchon-dong, Gangdong-ku, Seoul,  
Republic of Korea.

(540) Trademark Application

**MR BLACK**

(511) 33

(210) No. 49343

(220) 22/11/2023

(732) DIAGEO NORTH AMERICA, INC.

3 World Trade Center 175 Greenwich Street  
New York, NY 10007,  
United States of America.

(540) Trademark Application

**TOP CAFÉ**

(511) 30

(210) No. 49354

(220) 23/11/2023

(732) PT WINGS SURYA

Jl. Kalisosok Kidul No. 02, Desa/Kelurahan  
Krempangan Selatan, Kec. Krempangan, Kota  
Surabaya, Provinsi Jawa Timur, Indonesia.

(540) Trademark Application



(511) 29 and 43

(210) No. 49356

(220) 23/11/2023

(732) ZHENGZHOU RUNXIANG CATERING  
MANAGEMENT CO., LTD.

Room 62, 14th Floor, Building 5, No.218  
Xinzheng Road, Guancheng District,  
Zhengzhou, Henan Province, China.

(540) Trademark Application

**RONTAMIL**

(511) 05

(210) No. 49357

(220) 23/11/2023

(732) DREAVIA AG

BAHNHOFSTRASSE 7, CH 6300 ZUG,  
SWITZERLAND.

(540) Trademark Application

**RONTAMEAL**

(511) 05, 29, 30 and 32

(210) No. 49358

(220) 23/11/2023

(732) DREAVIA AG

BAHNHOFSTRASSE 7, CH 6300 ZUG,  
SWITZERLAND.

(540) Trademark Application



(511) 30

(210) No. 49359

(220) 23/11/2023

(732) CALLETON (GROUP) CO., LTD

No.366 Houcuo, Qiancuo Village, Haicheng  
Town, Longhai District, Zhangzhou City,  
Fujian Province, China.

(540) Trademark Application



(511) 35 and 37

(210) No. 49360

(220) 24/11/2023

(732) ບໍລິສັດ ລາວຊິນເທິເຫຼັກກ້າ ແລະ ພັດທະນາບໍ່ແຮ່

ຈຳກັດ

ບ້ານ ພະຂາວ, ເມືອງ ໄຊທານີ, ນະຄອນຫຼວງວຽງຈັນ,

ສປປ ລາວ

(540) Trademark Application

**DAY BREAK**

(511) 30

(210) No. 49361

(220) 24/11/2023

(732) INTERNATIONAL FOODSTUFFS CO. LLC

Al-Wahda Street, Industrial Area No.1, P.O.

Box No.4115, Sharjah, United Arab Emirates.

(540) Trademark Application

**ADORE**

(511) 30

(210) No. 49362

(220) 24/11/2023

(732) INTERNATIONAL FOODSTUFFS CO. LLC

Al-Wahda Street, Industrial Area No.1, P.O.

Box No.4115, Sharjah, United Arab Emirates.

(540) Trademark Application

**BREAKSTA**

(511) 30

(210) No. 49363

(220) 24/11/2023

(732) INTERNATIONAL FOODSTUFFS CO. LLC

Al-Wahda Street, Industrial Area No.1, P.O.

Box No.4115, Sharjah, United Arab Emirates.



(540) Trademark Application

**QUANTA  
BREAKTIME**

(511) 30

(210) No. 49364

(220) 24/11/2023

(732) INTERNATIONAL FOODSTUFFS CO. LLC

Al-Wahda Street, Industrial Area No.1, P.O.

Box No.4115, Sharjah, United Arab Emirates.

(540) Trademark Application

**BREAK RIZZO**

(511) 30

(210) No. 49365

(220) 24/11/2023

(732) INTERNATIONAL FOODSTUFFS CO. LLC

Al-Wahda Street, Industrial Area No.1, P.O.

Box No.4115, Sharjah, United Arab Emirates.

(540) Trademark Application

**BREAK DELIGHTS**

(511) 30

(210) No. 49366

(220) 24/11/2023

(732) INTERNATIONAL FOODSTUFFS CO. LLC

Al-Wahda Street, Industrial Area No.1, P.O.

Box No.4115, Sharjah, United Arab Emirates.

(540) Trademark Application

**BREAK SUPA**

(511) 30

(210) No. 49367

(220) 24/11/2023

(732) INTERNATIONAL FOODSTUFFS CO. LLC

Al-Wahda Street, Industrial Area No.1, P.O.

Box No.4115, Sharjah, United Arab Emirates.

(540) Trademark Application

**BIG BREAK**

(511) 30

(210) No. 49368

(220) 24/11/2023

(732) INTERNATIONAL FOODSTUFFS CO. LLC

Al-Wahda Street, Industrial Area No.1, P.O.

Box No.4115, Sharjah, United Arab Emirates.

(540) Trademark Application

**HANKO**

(511) 30

(210) No. 49369

(220) 24/11/2023

(732) INTERNATIONAL FOODSTUFFS CO. LLC

Al-Wahda Street, Industrial Area No.1, P.O.

Box No.4115, Sharjah, United Arab Emirates.

(540) Trademark Application

**ROXTA**

(511) 30

(210) No. 49370

(220) 24/11/2023

(732) INTERNATIONAL FOODSTUFFS CO. LLC

Al-Wahda Street, Industrial Area No.1, P.O.

Box No.4115, Sharjah, United Arab Emirates.

(540) Trademark Application

**RICCO**

(511) 30

(210) No. 49371

(220) 24/11/2023

(732) INTERNATIONAL FOODSTUFFS CO. LLC

Al-Wahda Street, Industrial Area No.1, P.O.

Box No.4115, Sharjah, United Arab Emirates.

(540) Trademark Application

**TEAM UP**

(511) 30

(210) No. 49372

(220) 24/11/2023

(732) INTERNATIONAL FOODSTUFFS CO. LLC

Al-Wahda Street, Industrial Area No.1, P.O.

Box No.4115, Sharjah, United Arab Emirates.

(540) Trademark Application

**BRIO**

(511) 30

(210) No. 49373

(220) 24/11/2023

(732) INTERNATIONAL FOODSTUFFS CO. LLC

Al-Wahda Street, Industrial Area No.1, P.O.

Box No.4115, Sharjah, United Arab Emirates.

(540) Trademark Application

**HAPPY BREAK**

(511) 30

(210) No. 49374

(220) 24/11/2023

(732) INTERNATIONAL FOODSTUFFS CO. LLC

Al-Wahda Street, Industrial Area No.1, P.O.

Box No.4115, Sharjah, United Arab Emirates.

(540) Trademark Application

**GONUTS**

(511) 30

(210) No. 49375

(220) 24/11/2023

(732) INTERNATIONAL FOODSTUFFS CO. LLC

Al-Wahda Street, Industrial Area No.1, P.O.

Box No.4115, Sharjah, United Arab Emirates.

(540) Trademark Application

**SPADA**

(511) 30

(210) No. 49376

(220) 24/11/2023

(732) INTERNATIONAL FOODSTUFFS CO. LLC

Al-Wahda Street, Industrial Area No.1, P.O.

Box No.4115, Sharjah, United Arab Emirates.

(540) Trademark Application

**KRAEMER**

(511) 30

(210) No. 49377

(220) 24/11/2023

(732) INTERNATIONAL FOODSTUFFS CO. LLC

Al-Wahda Street, Industrial Area No.1, P.O.

Box No.4115, Sharjah, United Arab Emirates.

(540) Trademark Application

**CARAWHEEL**

(511) 30

(210) No. 49378

(220) 24/11/2023

(732) INTERNATIONAL FOODSTUFFS CO. LLC

Al-Wahda Street, Industrial Area No.1, P.O.

Box No.4115, Sharjah, United Arab Emirates.

(540) Trademark Application

**PEAKS**

(511) 30

(210) No. 49379

(220) 24/11/2023

(732) INTERNATIONAL FOODSTUFFS CO. LLC

Al-Wahda Street, Industrial Area No.1, P.O.

Box No.4115, Sharjah, United Arab Emirates.



(540) Trademark Application

**FRESCO**

(511) 30

(210) No. 49380

(220) 24/11/2023

(732) INTERNATIONAL FOODSTUFFS CO. LLC

Al-Wahda Street, Industrial Area No.1, P.O.

Box No.4115, Sharjah, United Arab Emirates.

(540) Trademark Application

**RUSH**

(511) 30

(210) No. 49381

(220) 24/11/2023

(732) INTERNATIONAL FOODSTUFFS CO. LLC

Al-Wahda Street, Industrial Area No.1, P.O.

Box No.4115, Sharjah, United Arab Emirates.

(540) Trademark Application

**SCALA**

(511) 30

(210) No. 49382

(220) 24/11/2023

(732) INTERNATIONAL FOODSTUFFS CO. LLC

Al-Wahda Street, Industrial Area No.1, P.O.

Box No.4115, Sharjah, United Arab Emirates.

(540) Trademark Application

**DESIRE**

(511) 30

(210) No. 49383

(220) 24/11/2023

(732) INTERNATIONAL FOODSTUFFS CO. LLC

Al-Wahda Street, Industrial Area No.1, P.O.

Box No.4115, Sharjah, United Arab Emirates.

(540) Trademark Application

**WOLFY**

(511) 30

(210) No. 49384

(220) 24/11/2023

(732) INTERNATIONAL FOODSTUFFS CO. LLC

Al-Wahda Street, Industrial Area No.1, P.O.

Box No.4115, Sharjah, United Arab Emirates.

(540) Trademark Application

**ALMONDAY**

(511) 30

(210) No. 49385

(220) 24/11/2023

(732) INTERNATIONAL FOODSTUFFS CO. LLC

Al-Wahda Street, Industrial Area No.1, P.O.

Box No.4115, Sharjah, United Arab Emirates.

(540) Trademark Application

**MAJESTO**

(511) 30

(210) No. 49386

(220) 24/11/2023

(732) INTERNATIONAL FOODSTUFFS CO. LLC

Al-Wahda Street, Industrial Area No.1, P.O.

Box No.4115, Sharjah, United Arab Emirates.

(540) Trademark Application

**IGLOO GOLD BAR**

(511) 30

(210) No. 49387

(220) 24/11/2023

(732) INTERNATIONAL FOODSTUFFS CO. LLC

Al-Wahda Street, Industrial Area No.1, P.O.

Box No.4115, Sharjah, United Arab Emirates.

(540) Trademark Application

**WAFEROO**

(511) 30

(210) No. 49388

(220) 24/11/2023

(732) INTERNATIONAL FOODSTUFFS CO. LLC

Al-Wahda Street, Industrial Area No.1, P.O.

Box No.4115, Sharjah, United Arab Emirates.

(540) Trademark Application

**OH WOW**

(511) 30

(210) No. 49389

(220) 24/11/2023

(732) INTERNATIONAL FOODSTUFFS CO. LLC

Al-Wahda Street, Industrial Area No.1, P.O.

Box No.4115, Sharjah, United Arab Emirates.

(540) Trademark Application

**WOW**

(511) 30

(210) No. 49390

(220) 24/11/2023

(732) INTERNATIONAL FOODSTUFFS CO. LLC

Al-Wahda Street, Industrial Area No.1, P.O.

Box No.4115, Sharjah, United Arab Emirates.

(540) Trademark Application

**ARMADA**

(511) 30

(210) No. 49391

(220) 24/11/2023

(732) INTERNATIONAL FOODSTUFFS CO. LLC

Al-Wahda Street, Industrial Area No.1, P.O.

Box No.4115, Sharjah, United Arab Emirates.

(540) Trademark Application

**COMBO**

(511) 30

(210) No. 49392

(220) 24/11/2023

(732) INTERNATIONAL FOODSTUFFS CO. LLC

Al-Wahda Street, Industrial Area No.1, P.O.

Box No.4115, Sharjah, United Arab Emirates.

(540) Trademark Application

**PALM BEACH**

(511) 30

(210) No. 49393

(220) 25/11/2023

(732) INTERNATIONAL FOODSTUFFS CO. LLC

Al-Wahda Street, Industrial Area No.1, P.O.

Box No.4115, Sharjah, United Arab Emirates.

(540) Trademark Application

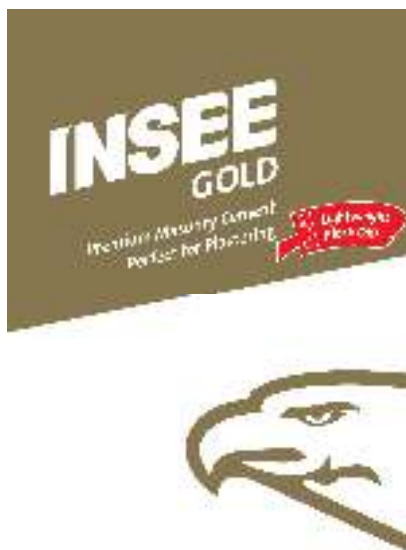

(511) 19

(210) No. 49395

(220) 27/11/2023

(732) Siam City Cement Public Company Limited  
199 Column Tower, Ratchadapisek Road,  
Klongtoey, Bangkok 10110, Thailand.

(540) Trademark Application



(511) 19

(210) No. 49396

(220) 27/11/2023

(732) Siam City Cement Public Company Limited  
199 Column Tower, Ratchadapisek Road,  
Klongtoey, Bangkok 10110, Thailand.



(540) Trademark Application

**biaze**

(511) 09

(210) No. 49397

(220) 27/11/2023

(732) Shenzhen Biaze Technology Co., LTD

1501, Building 2 Pengyuan, No. 18, Lilang  
Road, Shanglilang Community, Nanwan  
Street, Longgang District, Shenzhen, China.

(540) Trademark Application

**PAXA**

(511) 09

(210) No. 49398

(220) 28/11/2023

(732) SHANGHAI WEIHONGHANG CULTURE  
COMMUNICATION CO., LTD

(Shanghai Hengtai Jingji Kaifa Zone) No.58  
Fumin Branch Rd, Hengsha Township,  
Chongming, Shanghai, China.

(540) Trademark Application

**QUANTA SQUARES**

(511) 30

(210) No. 49399

(220) 28/11/2023

(732) INTERNATIONAL FOODSTUFFS CO. LLC

Al-Wahda Street, Industrial Area No.1, P.O.

Box No.4115, Sharjah, United Arab Emirates.

(540) Trademark Application



(511) 30

(210) No. 49401

(220) 29/11/2023

(732) T.MAN PHARMACEUTICAL PUBLIC

COMPANY LIMITED

No. 69/1 Soi Bangkhunthian 14, Bangkhutian

Road, Samaedum, Bangkhunthian, Bangkok,

Thailand.

(540) Trademark Application



(511) 05

(210) No. 49402

(220) 29/11/2023

(732) T.MAN PHARMACEUTICAL PUBLIC  
COMPANY LIMITED

No. 69/1 Soi Bangkhunthian 14, Bangkhutian  
Road, Samaedum, Bangkhunthian, Bangkok,  
Thailand.

(540) Trademark Application



(511) 03

(210) No. 49403

(220) 29/11/2023

(732) T.MAN PHARMACEUTICAL PUBLIC  
COMPANY LIMITED

No. 69/1 Soi Bangkhunthian 14, Bangkhutian  
Road, Samaedum, Bangkhunthian, Bangkok,  
Thailand.

(540) Trademark Application



(511) 30

(210) No. 49404

(220) 29/11/2023

(732) INTERNATIONAL FOODSTUFFS CO.  
LLC

Al-Wahda Street, Industrial Area No.1, P.O.  
Box No.4115, Sharjah, United Arab Emirates.

(540) Trademark Application



(511) 30

(210) No. 49405

(220) 29/11/2023

(732) INTERNATIONAL FOODSTUFFS CO.  
LLC

Al-Wahda Street, Industrial Area No.1, P.O.  
Box No.4115, Sharjah, United Arab Emirates.

(540) Trademark Application



(511) 30

(210) No. 49406

(220) 29/11/2023

(732) INTERNATIONAL FOODSTUFFS CO.  
LLC

Al-Wahda Street, Industrial Area No.1, P.O.  
Box No.4115, Sharjah, United Arab Emirates.

(540) Trademark Application

**JUICE UP**

(511) 32

(210) No. 49407

(220) 29/11/2023

(732) INTERNATIONAL FOODSTUFFS CO. LLC  
Al-Wahda Street, Industrial Area No.1, P.O.  
Box No.4115, Sharjah, United Arab Emirates.

(540) Trademark Application

The logo for NEVO is the word "NEVO" in a bold, uppercase, sans-serif font. The letters are filled with a dense, stippled or pixelated pattern, giving it a textured, digital appearance.

(511) 12

(210) No. 49408

(220) 29/11/2023

(732) CHONGQING CHANGAN AUTOMOBILE  
CO., LTD.

260 Jianxin East Road, Jiangbei District,  
Chongqing, China.

(540) Trademark Application

The logo for LIGUANG features a stylized, bold, black graphic element above the word "LIGUANG" in a bold, uppercase, sans-serif font. The graphic element consists of a thick, black shape that resembles a stylized letter 'G' or a similar geometric form, with a white negative space cutout.

(511) 12

(210) No. 49409

(220) 30/11/2023

(732) ZHEJIANG PROVINCE LIGUANG  
MOTORCYCLE FITTINGS CO., LTD.

Li'ao Northern Industry Zone (South of the  
Ouhai Stone Market), Ouhai District,  
Wenzhou City, Zhejiang Province, China.

(540) Trademark Application

The logo consists of the words "HO UNA" in a bold, blue, sans-serif font. The letters are spaced out, with "HO" on the left and "UNA" on the right.

(511) 12

(210) No. 49411

(220) 01/12/2023

(732) ບໍລິສັດ ເຄຕິພີ ການຄ້າຂາອອກ-ຂາເຂົ້າ ຈຳກັດຜູ້ດຽວ  
ບ້ານ ຫ້ວຍນ້ຳເຢັນ ເມືອງ ນາຊາຍທອງ,  
ນະຄອນຫຼວງວຽງຈັນ, ສປປ ລາວ

(540) Trademark Application

The logo features a stylized, colorful wave or ribbon shape in shades of green, yellow, and orange. Below the graphic, the text "XINXIN FOOD" is written in a bold, black, sans-serif font, with the Chinese characters "心心食品" underneath.

(511) 35

(210) No. 49414

(220) 05/12/2023

(732) ໂຮງງານ ປຸງແຕ່ງອາຫານ ຊິນຊິນ ຈຳກັດ  
ບ້ານ ໂພນສະຫວັນ, ເມືອງ ໄຊທານີ,  
ນະຄອນຫຼວງວຽງຈັນ, ສປປ ລາວ

(540) Trademark Application



(511) 44

(210) No. 49415

(220) 05/12/2023

(732) ບໍລິສັດ ສຸນຄວາມງາມ ເອຟລັສ ບິວຕີ ເຊັນເຕີ  
ຈຳກັດຜູ້ດຽວ

ບ້ານ ທາດຫຼວງກາງ, ເມືອງ ໄຊເສດຖາ,  
ນະຄອນຫຼວງວຽງຈັນ, ສປປ ລາວ

(540) Trademark Application



(511) 05 and 35

(210) No. 49419

(220) 06/12/2023

(732) ບໍລິສັດ ເຮຊັນຟາມາຊຸທິໂກ (ລາວ) ຈຳກັດ  
ບ້ານ ໜອງບົວທອງໃຕ້, ເມືອງ ສີໂຄດຕະບອງ,  
ນະຄອນຫຼວງວຽງຈັນ, ສປປ ລາວ



## ພາກທີ III

### (Part III)

## ເຄື່ອງໝາຍການຄ້າ

### Trademarks

#### 2. ຜົນການຈົດທະບຽນ

##### (Registration)

##### ຄຳອະທິບາຍກ່ຽວກັບລະຫັດຫຍໍ້

##### (Introduction of Codes)

- (540) ເຄື່ອງໝາຍການຄ້າ (Trademark)
- (511) ໝວດ (Nice Classification)
- (210) ເລກທີ ຄຳຮ້ອງ (Number of the application)
- (220) ວັນທີ ຄຳຮ້ອງ (Date of filing of the application)
- (732) ຊື່ ແລະ ທີ່ຢູ່ ຂອງຜູ້ຍື່ນຄຳຮ້ອງ (Name and Address of applicant)
- (111) ເລກທີ ການຈົດທະບຽນເຄື່ອງໝາຍການຄ້າ (Number of the registration)
- (180) ວັນໝົດອາຍຸຂອງການຈົດທະບຽນ (Expiration date of the registration)

(540) Registration



(511) 03, 05, 30 and 32

(210) No. 49136

(220) 23/10/2023

(732) ນາງ ມ່ອງ ບົວຄຳດີ

ບ້ານ ໂພນທັນ, ເມືອງໄຊເສດຖາ,

ນະຄອນຫຼວງວຽງຈັນ, ສປປ ລາວ

(111) No. 60983

(180) 23/10/2033

(540) Registration



(511) 01

(210) No. 49137

(220) 23/10/2023

(732) ທ່ານ ນາງ ເຂັມຄຳ ລັດທິດາ

ບ້ານ ດົງສະຫວາດ, ເມືອງ ສີສັດຕະນາກ,

ນະຄອນຫຼວງວຽງຈັນ, ສປປ ລາວ

(111) No. 60984

(180) 23/10/2033

(540) Registration



(511) 16

(210) No. 49138

(220) 23/10/2023

(732) ນາງ ມາລາວິງ ມະນີແສງ

ບ້ານ ນາສາລາ, ເມືອງ ໄຊທານີ, ນະຄອນຫຼວງວຽງຈັນ,  
ສປປ ລາວ

(111) No. 60985

(180) 23/10/2033

(540) Registration



(511) 25

(210) No. 49139

(220) 23/10/2023

(732) ນາງ ດາວວອນ ໄຊຍະບຸນຊຸ

ບ້ານ ພະໂພ, ເມືອງ ສີສັດຕະນາກ,  
ນະຄອນຫຼວງວຽງຈັນ , ສປປ ລາວ

(111) No. 60986

(180) 23/10/2033

(540) Registration



(511) 30

(210) No. 49140

(220) 23/10/2023

(732) ໂຮງງານ ຜະລິດນ້ຳມັນໝາກຜ້າວ ສະກັດເຢັນ ວິລະວັງ

ສ່ວນບຸກຄົນ

ບ້ານ ທ່ານາ, ເມືອງ ຫາດຊາຍຝອງ,

ນະຄອນຫຼວງວຽງຈັນ, ສປປ ລາວ

(111) No. 60987

(180) 23/10/2033

(540) Registration



(511) 05

(210) No. 49141

(220) 23/10/2023

(732) ວິສາຫະກິດສ່ວນບຸກຄົນ ຫ້ອງປຸງແຕ່ງຢາພື້ນເມືອງ

ກາສິງທອງ

ບ້ານ ຊຽງດາ, ເມືອງ ໄຊເສດຖາ, ນະຄອນຫຼວງວຽງຈັນ,

ສປປ ລາວ

(111) No. 60988

(180) 23/10/2033

(540) Registration



(511) 05

(210) No. 49142

(220) 23/10/2023

(732) ວິສາຫະກິດສ່ວນບຸກຄົນ ຫ້ອງປຸງແຕ່ງຢາພື້ນເມືອງ

ກາເສືອ 1 ໂຕ

ບ້ານ ໜອງດ້ວງທົ່ງ, ເມືອງ ສີໂຄດຕະບອງ,

ນະຄອນຫຼວງວຽງຈັນ, ສປປ ລາວ

(111) No. 60989

(180) 23/10/2033

(540) Registration



(511) 30

(210) No. 49143

(220) 23/10/2023

(732) ວິສາຫະກິດ ຍອດຊຳ ສ່ວນບຸກຄົນ

ບ້ານ ກາງ, ເມືອງ ຊຳເໜືອ, ແຂວງ ຫົວພັນ,

ສປປ ລາວ

(111) No. 60990

(180) 23/10/2033

(540) Registration



(511) 05

(210) No. 49144

(220) 23/10/2023

(732) ວິສາຫະກິດສ່ວນບຸກຄົນ ໂຮງງານ ຢາກາມັງກອນ

ບ້ານ ວຽງສະຫວັນ, ເມືອງ ສີໂຄດຕະບອງ,

ນະຄອນຫຼວງວຽງຈັນ, ສປປ ລາວ

(111) No. 60991

(180) 23/10/2033

(540) Registration



(511) 30

(210) No. 49145

(220) 23/10/2023

(732) ນາງ ວັນມະນີ ຈັນງາຄຳ

ບ້ານ ໜ່ອງໜ່ຽງ, ເມືອງ ໄຊທານີ,

ນະຄອນຫຼວງວຽງຈັນ, ສປປ ລາວ

(111) No. 60992

(180) 23/10/2033

(540) Registration



(511) 36

(210) No. 49155

(220) 25/10/2023

(732) ບໍລິສັດ ຮຸ່ງເຮືອງ ບໍລິຫານອະສັງຫາລິມະຊັບ

ຈໍາກັດຜູ້ດຽວ

ບ້ານ ໜອງບອນ, ເມືອງ ໄຊເສດຖາ,

ນະຄອນຫຼວງວຽງຈັນ, ສປປ ລາວ

(111) No. 60993

(180) 25/10/2033

(540) Registration



(511) 36

(210) No. 49157

(220) 25/10/2023

(732) ບໍລິສັດ ຖືຮຸ້ນ ລ້ານຊ້າງ ຈໍາກັດຜູ້ດຽວ

ຖະໜົນ 23 ສິງຫາ, ບ້ານ ໜອງບອນ,

ເມືອງ ໄຊເສດຖາ, ນະຄອນຫຼວງວຽງຈັນ, ສປປ ລາວ

(111) No. 60994

(180) 25/10/2033

(540) Registration



(511) 39

(210) No. 49158

(220) 25/10/2023

(732) ບໍລິສັດ ລາວ ສະມາດ ໂມບິລິຕີ ຈຳກັດ

ຖະໜົນ 23 ສິງຫາ, ບ້ານ ໜອງບອນ,

ເມືອງ ໄຊເສດຖາ, ນະຄອນຫຼວງວຽງຈັນ, ສປປ ລາວ

(111) No. 60995

(180) 25/10/2033

(540) Registration



(511) 37

(210) No. 49159

(220) 25/10/2023

(732) ບໍລິສັດ ຮິດຈໍຣີສອດສ໌ ຈຳກັດ

ບ້ານ ໜອງບອນ, ເມືອງ ໄຊເສດຖາ,

ນະຄອນຫຼວງວຽງຈັນ, ສປປ ລາວ

(111) No. 60996

(180) 25/10/2033



(540) Registration



(511) 37

(210) No. 49160

(220) 25/10/2023

(732) ບໍລິສັດ ແຮ່ທາດລາວ ຈຳກັດ

ຖະໜົນ 23 ສິງຫາ, ບ້ານ ໜອງບອນ,

ເມືອງ ໄຊເສດຖາ, ນະຄອນຫຼວງວຽງຈັນ, ສປປ ລາວ

(111) No. 60997

(180) 25/10/2033

(540) Registration



(511) 06 and 19

(210) No. 49168

(220) 25/10/2023

(732) ບໍລິສັດ ຫໍ່ນໍ້າລາວ ອຸດສາຫະກຳ ເທັກໂນໂລຢີ

ຈຳກັດຜູ້ດຽວ

ບ້ານ ໜອງໜ່ຽງ, ເມືອງ ໄຊທານີ,

ນະຄອນຫຼວງວຽງຈັນ, ສປປ ລາວ

(111) No. 60998

(180) 25/10/2033

(540) Registration



(511) 06 and 19

(210) No. 49169

(220) 25/10/2023

(732) ບໍລິສັດ ທໍ່ນໍ້າລາວ ອຸດສາຫະກໍາ ເທັກໂນໂລຢີ

ຈໍາກັດຜູ້ດຽວ

ບ້ານ ໜອງໜ່ຽງ, ເມືອງ ໄຊເສດຖາ,

ນະຄອນຫຼວງວຽງຈັນ, ສປປ ລາວ

(111) No. 60999

(180) 25/10/2033

(540) Registration



(511) 24

(210) No. 49180

(220) 26/10/2023

(732) ທ້າວ ເມສາ ສັງທອງວິດຈິດຣ໌

ບ້ານ ນາທິມ, ເມືອງ ໄຊທານີ, ນະຄອນຫຼວງວຽງຈັນ,

ສປປ ລາວ

(111) No. 61000

(180) 26/10/2033

(540) Registration



(511) 24  
(210) No. 49182  
(220) 26/10/2023  
(732) ຮ້ານ ກິນນາລີ ດີຊາຍ ສ່ວນບຸກຄົນ  
ບ້ານ ວຽງຈະເລີນ, ເມືອງ ໄຊເສດຖາ,  
ນະຄອນຫຼວງວຽງຈັນ, ສປປ ລາວ  
(111) No. 61001  
(180) 26/10/2033

(540) Registration



(511) 43  
(210) No. 49183  
(220) 26/10/2023  
(732) ວິສາຫະກິດ ສ່ວນບຸກຄົນ ຮ້ານ ປ້ຽງປ້ຽງ ໝາລ້າທ້າງ  
ບ້ານ ໜອງດ້ວງໃຕ້, ເມືອງ ສີໂຄດຕະບອງ,  
ນະຄອນຫຼວງວຽງຈັນ, ສປປ ລາວ  
(111) No. 61002  
(180) 26/10/2033

(540) Registration



(511) 43

(210) No. 49184

(220) 26/10/2023

(732) ວິສາຫະກິດ ສວນບຸກຄົນ ຮ້ານ ປ້ຽງປ້ຽງ ຫົວກົວ  
ຮ່ອດຜ່ອດ

ບ້ານ ສີບຸນເຮືອງ, ເມືອງ ຈັນທະບູລີ,  
ນະຄອນຫຼວງວຽງຈັນ, ສປປ ລາວ

(111) No. 61003

(180) 26/10/2033

(540) Registration



(511) 01

(210) No. 49185

(220) 27/10/2023

(732) ບໍລິສັດ ກ້າວໜ້າ ການກະເສດ ແລະ ອຸດສາຫະກຳ  
ການຄ້າ ຂາອອກ-ຂາເຂົ້າ ຈຳກັດ  
ຖະໜົນ 13 ໄຕ້, ບ້ານ ບຶງຫົວນາ, ເມືອງເຊບັ້ງໄຟ,  
ແຂວງ ຄຳມ່ວນ, ສປປ ລາວ

(111) No. 61004

(180) 27/10/2033

(540) Registration



(511) 12

(210) No. 49187

(220) 27/10/2023

(732) ບໍລິສັດ ເຄອິສະຕາ ນໍາເຂົ້າ ແລະ ສົ່ງອອກ ຈໍາກັດຜູ້ດຽວ  
ບ້ານ ທາດຫຼວງໃຕ້, ເມືອງ ໄຊເສດຖາ,  
ນະຄອນຫຼວງວຽງຈັນ, ສປປ ລາວ

(111) No. 61005

(180) 27/10/2033

(540) Registration

**SUPEKA**

(511) 12

(210) No. 49188

(220) 27/10/2023

(732) ບໍລິສັດ ເຄອິສະຕາ ນໍາເຂົ້າ ແລະ ສົ່ງອອກ ຈໍາກັດຜູ້ດຽວ  
ບ້ານ ທາດຫຼວງໃຕ້, ເມືອງ ໄຊເສດຖາ,  
ນະຄອນຫຼວງວຽງຈັນ, ສປປ ລາວ

(111) No. 61006

(180) 27/10/2033

(540) Registration

**KUBOKI**

(511) 12

(210) No. 49189

(220) 27/10/2023

(732) ບໍລິສັດ ເຄອິສະຕາ ນໍາເຂົ້າ ແລະ ສົ່ງອອກ ຈຳກັດຜູ້ດຽວ  
ບ້ານ ທາດຫຼວງໃຕ້, ເມືອງ ໄຊເສດຖາ,  
ນະຄອນຫຼວງວຽງຈັນ, ສປປ ລາວ

(111) No. 61007

(180) 27/10/2033

(540) Registration

**HANABI**

(511) 12

(210) No. 49190

(220) 27/10/2023

(732) ບໍລິສັດ ເຄອິສະຕາ ນໍາເຂົ້າ ແລະ ສົ່ງອອກ ຈຳກັດຜູ້ດຽວ  
ບ້ານ ທາດຫຼວງໃຕ້, ເມືອງ ໄຊເສດຖາ,  
ນະຄອນຫຼວງວຽງຈັນ, ສປປ ລາວ

(111) No. 61008

(180) 27/10/2033

(540) Registration



(511) 12

(210) No. 49191

(220) 27/10/2023

(732) ບໍລິສັດ ເຄອິສະຕາ ນໍາເຂົ້າ ແລະ ສົ່ງອອກ ຈໍາກັດຜູ້ດຽວ

ບ້ານ ທາດຫຼວງໃຕ້, ເມືອງ ໄຊເສດຖາ,

ນະຄອນຫຼວງວຽງຈັນ, ສປປ ລາວ

(111) No. 61009

(180) 27/10/2033

(540) Registration

**KONABI**

(511) 12

(210) No. 49192

(220) 27/10/2023

(732) ບໍລິສັດ ເຄອິສະຕາ ນໍາເຂົ້າ ແລະ ສົ່ງອອກ ຈໍາກັດຜູ້ດຽວ

ບ້ານ ທາດຫຼວງໃຕ້, ເມືອງ ໄຊເສດຖາ,

ນະຄອນຫຼວງວຽງຈັນ, ສປປ ລາວ

(111) No. 61010

(180) 27/10/2033

(540) Registration

**MIKIREI**

(511) 16

(210) No. 49146

(220) 23/10/2023

(732) LIHONG HE

No. 152, Mixi Village, Suxi Town, Yiwu

City, Jinhua City, Zhejiang Province, China

(111) No. 61011

(180) 23/10/2033

(540) Registration



(511) 16

(210) No. 49154

(220) 24/10/2023

(732) YUNNAN XINGLIANG INDUSTRIAL  
CO.,LTD

No.55 Guanyinsi, Huangtupo Road, Western

Suburb, Wuhua District, Kunming, Yunnan

Province, China

(111) No. 61012

(180) 24/10/2033



(540) Registration

**AIFEN**

**AIFEN**

(511) 09

(210) No. 49161

(220) 25/10/2023

(732) Foshan Cengon Electronic Intelligent  
Equipment Co., Ltd

Rm. 502, Bldg. 4 Shunde Wanyang Crowd  
Innovation Park,8-1 West Area 1st Rd.,  
Xiantang Vil., Longjiang Town, Shunde  
Dist., Foshan City, Guangdong Province,  
China

(111) No. 61013

(180) 25/10/2033

(540) Registration

**AIFEN**

(511) 11

(210) No. 49162

(220) 25/10/2023

(732) Foshan Cengon Electronic Intelligent  
Equipment Co., Ltd

Rm. 502, Bldg. 4 Shunde Wanyang Crowd  
Innovation Park,8-1 West Area 1st Rd.,  
Xiantang Vil., Longjiang Town, Shunde  
Dist., Foshan City , Guangdong Province,  
China

(111) No. 61014

(180) 25/10/2033

(540) Registration

**SUGON**

(511) 09

(210) No. 49163

(220) 25/10/2023

(732) Foshan Cengon Electronic Intelligent  
Equipment Co., Ltd

Rm. 502, Bldg. 4 Shunde Wanyang Crowd  
Innovation Park,8-1 West Area 1st Rd.,  
Xiantang Vil., Longjiang Town, Shunde  
Dist., Foshan City , Guangdong Province,  
China

(111) No. 61015

(180) 25/10/2033

(540) Registration

**SUGON**

(511) 11

(210) No. 49164

(220) 25/10/2023

(732) Foshan Cengon Electronic Intelligent  
Equipment Co., Ltd

Rm. 502, Bldg. 4 Shunde Wanyang Crowd  
Innovation Park,8-1 West Area 1st Rd.,  
Xiantang Vil., Longjiang Town, Shunde  
Dist., Foshan City, Guangdong Province,  
China

(111) No. 61016

(180) 25/10/2033

(540) Registration

The logo for LI'ER is displayed in a bold, black, sans-serif font. The letters 'L', 'I', and 'R' are significantly larger than the apostrophe and the letter 'E'. The apostrophe is positioned between the 'I' and the 'R'.

(511) 05

(210) No. 49170

(220) 25/10/2023

(732) LIER CHEMICAL CO., LTD.

Economic & Technical Development Zone of  
Mianyang City, Sichuan Province, P.R, China

(111) No. 61017

(180) 25/10/2033

(540) Registration

The logo for SH-RD is displayed in a light gray, outlined, sans-serif font. The letters 'S', 'H', and 'R' are significantly larger than the hyphen and the letter 'D'. The hyphen is positioned between the 'H' and the 'R'.

(511) 03

(210) No. 49174

(220) 26/10/2023

(732) SHAAN HONQ INT'L COSMETICS CORP.

29F., No. 55, Zhongzheng 3rd Rd., Xinxing  
Dist., Kaohsiung City 800307, Taiwan  
(R.O.C.), Taiwan

(111) No. 61018

(180) 26/10/2033

(540) Registration



(511) 05

(210) No. 49175

(220) 26/10/2023

(732) LIER CHEMICAL CO., LTD.

Economic & Technical Development Zone of  
Mianyang City, Sichuan Province, P.R, China

(111) No. 61019

(180) 26/10/2033

(540) Registration



(511) 01

(210) No. 49176

(220) 26/10/2023

(732) GOLDEN CONCORD HOLDINGS  
LIMITED

Unit 1703B-1706, Level 17, International  
Commerce Centre, 1 Austin Road West,  
Kowloon, Hong Kong

(111) No. 61020

(180) 26/10/2033

(540) Registration



(511) 09

(210) No. 49177

(220) 26/10/2023

(732) GOLDEN CONCORD HOLDINGS  
LIMITED

unit 1703B-1706, Level 17, International  
commerce Centre, 1 Austin Road west,  
Kowloon, Hong Kong

(111) No. 61021

(180) 26/10/2033

(540) Registration



(511) 12

(210) No. 49178

(220) 26/10/2023

(732) SHANDONG LINGLONG TYRE CO., LTD.  
777, Jinlong Road, Zhaoyuan City, Shandong  
Province,, China

(111) No. 61022

(180) 26/10/2033

(540) Registration



(511) 35

(210) No. 49179

(220) 26/10/2023

(732) CHINA DUTY FREE GROUP CO., LTD.

Block A, Zhengdong International Building,  
No. 42, Dongzhimenwai Xiaojie, Dongcheng  
District, Beijing, China

(111) No. 61023

(180) 26/10/2033

(540) Registration



(511) 40

(210) No. 49193

(220) 27/10/2023

(732) JSP PHARMACEUTICAL

MANUFACTURING (THAILAID)  
PUBLIC COMPANY LIMITED

255, 257 Soi. Sathopradit 58, Bangpongpan,  
Yannawa, Bangkok, Thailand

(111) No. 61024

(180) 27/10/2033

(540) Registration

The logo for Tribox, featuring the word "Tribox" in a bold, sans-serif font.

(511) 34

(210) No. 49194

(220) 27/10/2023

(732) Shenzhen Kanger Technology Co., Ltd

2/F, Factory building A3, Tongwei

Optoelectronics Factory, No. 8 Gongye 2nd

Road, Shilong Community, Shiyuan Street,

Bao'an District, Shenzhen City, Guangdong

Province, China

(111) No. 61025

(180) 27/10/2033

(540) Registration

The logo for Yuebeifan, featuring a stylized Chinese character 'B' followed by the Chinese characters '月贝凡' and the English characters 'YUEBEIFAN' below it.

(511) 07

(210) No. 49195

(220) 27/10/2023

(732) Zhejiang Yuebei Fan Electromechanical Co.,

Ltd

No.6 Fangyan Road, Daxi Town, Wenling

City, Taizhou City, Zhejiang Province, China

(111) No. 61026

(180) 27/10/2033

(540) Registration



(511) 05

(210) No. 49196

(220) 30/10/2023

(732) JSP PHARMACEUTICAL

MANUFACTURING (THAILAID)

PUBLIC COMPANY LIMITED

255, 257 Soi. Sathopradit 58, Bangpongpan,

Yannawa, Bangkok, Thailand 10120,

Thailand

(111) No. 61027

(180) 30/10/2033

(540) Registration



(511) 30

(210) No. 43546

(220) 16/09/2019

(732) Lao Mountain Coffee

Nongbone Village, Saysettha District,

Vientien Capital, Lao PDR

(111) No. 61035

(180) 16/09/2029



(540) Registration



(511) 30

(210) No. 43546

(220) 16/09/2019

(732) Lao Mountain Coffee

Nongbone Village, Saysettha District,  
Vientien Capital, Lao PDR

(111) No. 61035

(180) 16/09/2029

(540) Registration



(511) 30

(210) No. 47451

(220) 22/09/2022

(732) CHEN KE MING FOOD

MANUFACTURING CO., LTD

No.1, Xingsheng Dadao Industrial Park,  
Nanxian County, Yiyang City, Hunan  
Province, China

(111) No. 61049

(180) 22/09/2032

(540) Registration



(511) 35  
(210) No. 48844  
(220) 18/08/2023  
(732) ຮ້ານ ເດີມູຟ ສ່ວນບຸກຄົນ (ນ. ພອນທິດາ ສິມສະອາດ)  
ບ້ານ ດົງປ່າລານທົ່ງ, ເມືອງ ສີສັດຕະນາກ,  
ນະຄອນຫຼວງວຽງຈັນ, ສປປ ລາວ  
(111) No. 61050  
(180) 18/08/2033

(540) Registration



(511) 43  
(210) No. 49249  
(220) 10/11/2023  
(732) ບໍລິສັດ ເອັສວີແອວ ການຄ້າ ຂາເຂົ້າ-ຂາອອກ  
ຈຳກັດຜູ້ດຽວ  
ບ້ານ ຊຽງຍືນ, ເມືອງ ຈັນທະບູລີ,  
ນະຄອນຫຼວງວຽງຈັນ, ສປປ ລາວ  
(111) No. 61086  
(180) 10/11/2033

(540) Registration

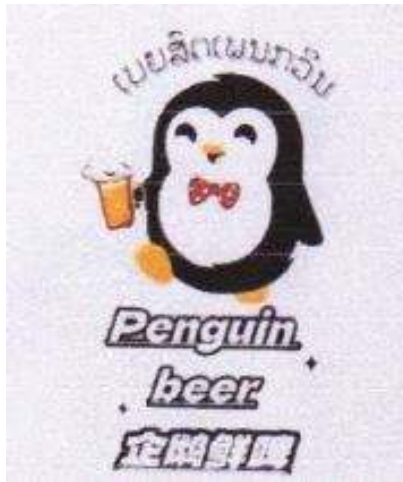

(511) 32

(210) No. 49209

(220) 01/11/2023

(732) ບໍລິສັດ ເບຍສິດເພນກວິນລາວ ຈຳກັດຜູ້ດຽວ(ທ່ານ ປີ່ຢຸນທ່າວ)

ບ້ານ ດອນມຸນ, ເມືອງ ຕົ້ນເຜິ້ງ, ແຂວງ ບໍ່ແກ້ວ, ສປປ ລາວ

(111) No. 61127

(180) 01/11/2033

(540) Registration



(511) 31

(210) No. 49210

(220) 01/11/2023

(732) ບໍລິສັດ ເຢົາເຈິນ ປຸກພິດກະສິກຳ ຈຳກັດ

ບ້ານ ນາສຳພັນ, ເມືອງ ຫຼວງພະບາງ,

ແຂວງ ຫຼວງພະບາງ, ສປປ ລາວ

(111) No. 61128

(180) 01/11/2033

(540) Registration



(511) 01

(210) No. 49211

(220) 01/11/2023

(732) ບໍລິສັດ ພອນທິດາຮັ່ງມີ ການຄ້າ ແລະ ກະສິກໍາ  
ຈຳກັດຜູ້ດຽວ

ບ້ານ ໂພນສະຫວາດເໜືອ, ເມືອງ ສີໂຄດຕະບອງ,  
ນະຄອນຫຼວງວຽງຈັນ, ສປປ ລາວ

(111) No. 61129

(180) 01/11/2033

(540) Registration



(511) 43

(210) No. 49212

(220) 01/11/2023

(732) ຮ້ານອາຫານ ຊານດ້າວຊາຍ ຢຸນນານ ຈຳກັດຜູ້ດຽວ

ບ້ານ ອຸບມຸງ, ເມືອງ ສີໂຄດຕະບອງ,  
ນະຄອນຫຼວງວຽງຈັນ, ສປປ ລາວ

(111) No. 61130

(180) 01/11/2033

(540) Registration



(511) 43

(210) No. 49217

(220) 02/11/2023

(732) ວິສາຫະກິດສ່ວນບຸກຄົນ ນ. ສຸລິໄທ ບໍລິການ

ຮ້ານກິນດື່ມ

ບ້ານ ເທິງ, ເມືອງ ຍອດອູ, ແຂວງ ຜົ້ງສາລີ, ສປປ ລາວ

(111) No. 61131

(180) 02/11/2033

(540) Registration



(511) 30

(210) No. 49218

(220) 02/11/2023

(732) ວິສາຫະກິດສ່ວນບຸກຄົນ ຮ້ານ ຂາຍຊາ ກຸ້ຍອິງ

ບ້ານ ຮົ່ມສະຫວ່າງ, ເມືອງຜົ້ງສາລີ, ແຂວງ ຜົ້ງສາລີ,

ສປປ ລາວ

(111) No. 61132

(180) 02/11/2033

(540) Registration



(511) 30

(210) No. 49219

(220) 02/11/2023

(732) ບໍລິສັດ ລົງມົງຈ້າວ ຈຳກັດຜູ້ດຽວ

ບ້ານ ຈ້າຜູ, ເມືອງ ຜົ້ງສາລີ, ແຂວງ ຜົ້ງສາລີ,

ສປປ ລາວ

(111) No. 61133

(180) 02/11/2033

(540) Registration



(511) 33

(210) No. 49220

(220) 02/11/2023

(732) ວິສາຫະກິດສ່ວນບຸກຄົນ ຕົ້ມເຫຼົ້າຜິ້ນເມືອງ ກາພູຕ່າສານ

ບ້ານ ໃຕ້, ເມືອງ ຍອດອູ, ແຂວງ ຜົ້ງສາລີ, ສປປ ລາວ

(111) No. 61134

(180) 02/11/2033

(540) Registration



(511) 25

(210) No. 49221

(220) 03/11/2023

(732) ບໍລິສັດ ເວັກເຕີ້ ມາເນຍ ຈຳກັດ  
ບ້ານ ໂພນໄຊ, ເມືອງ ໄຊເສດຖາ,  
ນະຄອນຫຼວງວຽງຈັນ, ສປປ ລາວ

(111) No. 61135

(180) 03/11/2033

(540) Registration



(511) 25

(210) No. 49222

(220) 03/11/2023

(732) ບໍລິສັດ ເວັກເຕີ້ ມາເນຍ ຈຳກັດ  
ບ້ານ ໂພນໄຊ, ເມືອງ ໄຊເສດຖາ,  
ນະຄອນຫຼວງວຽງຈັນ, ສປປ ລາວ

(111) No. 61136

(180) 03/11/2033

(540) Registration



(511) 31

(210) No. 49223

(220) 03/11/2023

(732) ບໍລິສັດ ຊີມໍ ຈຳກັດຜູ້ດຽວ

ບ້ານ ໂຊກໃຫຍ່, ເມືອງ ໄຊເສດຖາ,

ນະຄອນຫຼວງວຽງຈັນ, ສປປ ລາວ

(111) No. 61137

(180) 03/11/2033

(540) Registration



(511) 34

(210) No. 49224

(220) 03/11/2023

(732) ບໍລິສັດ ລົງທຶນການຢາ ມຸກຊິງ 1266 ຈຳກັດ

ບ້ານ ໂພນປ່າເບົ້າ, ເມືອງ ສີສັດຕະນາກ, ນະຄອນຫຼວງ

ວຽງຈັນ, ສປປ ລາວ

(111) No. 61138

(180) 03/11/2033



(540) Registration



(511) 39

(210) No. 49225

(220) 03/11/2023

(732) ບໍລິສັດ ມິດຕະພາບລາວຢູຮາວ ຈຳໜ່າຍພາຍໃນ

ຈຳກັດຜູ້ດຽວ

Lao Youhao Friendship Distributor Sole Co., LTD

ບ້ານ ໜອງທາ, ເມືອງ ຈັນທະບູລີ, ນະຄອນຫຼວງວຽງ

ຈັນ, ສປປ ລາວ

(111) No. 61139

(180) 03/11/2033

(540) Registration



(511) 35

(210) No. 49226

(220) 03/11/2023

(732) ບໍລິສັດ ມິດຕະພາບລາວຢູຮາວ ຈຳໜ່າຍພາຍໃນ

ຈຳກັດຜູ້ດຽວ

Lao Youhao Friendship Distributor Sole Co., LTD

ບ້ານ ໜອງທາ, ເມືອງ ຈັນທະບູລີ, ນະຄອນຫຼວງວຽງ

ຈັນ, ສປປ ລາວ

(111) No. 61140

(180) 03/11/2033

(540) Registration



(511) 35

(210) No. 49227

(220) 03/11/2023

(732) ບໍລິສັດ ເມືອງລາວ ຈຳກັດຜູ້ດຽວ  
ບ້ານ ໂຊກຄຳ, ເມືອງ ໄຊເສດຖາ,  
ນະຄອນຫຼວງວຽງຈັນ, ສປປ ລາວ

(111) No. 61141

(180) 03/11/2033

(540) Registration



(511) 36

(210) No. 49234

(220) 08/11/2023

(732) ບໍລິສັດ ລາວໂມບາຍມັນນີ ຈຳກັດຜູ້ດຽວ  
ບ້ານ ສາຍລຶມ ເມືອງ ຈັນທະບູລີ,  
ນະຄອນຫຼວງວຽງຈັນ, ສປປ ລາວ

(111) No. 61142

(180) 08/11/2033

(540) Registration



(511) 04

(210) No. 49239

(220) 09/11/2023

(732) ໂຮງງານ ຜະລິດຖານດຳ ແລະ ຖານຂາວອັດແຫ່ງເຄແອວ  
ຈຳກັດຜູ້ດຽວ

ບ້ານ ນາກຸ່ມ, ເມືອງ ທ່າແຂກ, ແຂວງ ຄຳມ່ວນ,  
ນະຄອນຫຼວງວຽງຈັນ, ສປປ ລາວ

(111) No. 61143

(180) 09/11/2033

(540) Registration



(511) 01

(210) No. 49241

(220) 09/11/2023

(732) ບໍລິສັດ ລາວ ຈິງທຽນ ອຸປະກອນກະສິກຳ ຂາອອກ-  
ຂາເຂົ້າ ຈຳກັດ

ບ້ານ ທາດຫຼວງໃຕ້, ເມືອງ ໄຊເສດຖາ,  
ນະຄອນຫຼວງວຽງຈັນ, ສປປ ລາວ

(111) No. 61144

(180) 09/11/2033

(540) Registration



(511) 30

(210) No. 49244

(220) 10/11/2023

(732) ກຸ່ມບໍລິສັດ ທ່ອງທ່ຽວ ວັດທະນະທຳລາວ ມະຫາຊື່ນ

ບ້ານ ໂພນພະເນົາ ເມືອງ ໄຊເສດຖາ,

ນະຄອນຫຼວງວຽງຈັນ, ສປປ ລາວ

(111) No. 61145

(180) 10/11/2033

(540) Registration



(511) 39

(210) No. 49245

(220) 10/11/2023

(732) ກຸ່ມບໍລິສັດ ທ່ອງທ່ຽວ ວັດທະນະທຳລາວ ມະຫາຊື່ນ

ບ້ານ ໂພນພະເນົາ ເມືອງ ໄຊເສດຖາ,

ນະຄອນຫຼວງວຽງຈັນ, ສປປ ລາວ

(111) No. 61146

(180) 10/11/2033

(540) Registration



(511) 43

(210) No. 49251

(220) 10/11/2023

(732) ບໍລິສັດ ລົງທຶນ ແລະ ພັດທະນາ ລ້ານຊ້າງ ຈຳກັດ

ບ້ານ ຊຽງຍືນ, ເມືອງ ຈັນທະບູລີ,

ນະຄອນຫຼວງວຽງຈັນ, ສປປ ລາວ

(111) No. 61147

(180) 10/11/2033

(540) Registration

Beita

(511) 25

(210) No. 49258

(220) 10/11/2023

(732) ບໍລິສັດ ຊຸນຟາ ຈຳກັດ

ບ້ານ ທົ່ງຕຸ້ມ, ເມືອງ ຈັນທະບູລີ,

ນະຄອນຫຼວງວຽງຈັນ, ສປປ ລາວ

(111) No. 61148

(180) 10/11/2033

(540) Registration



(511) 35

(210) No. 49260

(220) 13/11/2023

(732) ບໍລິສັດ ລາເບຍ ການຄ້າ ຂາເຂົ້າ - ຂາອອກ  
ຈຳກັດຜູ້ດຽວ

ບ້ານ ສົມສະຫງ່າ, ເມືອງ ໄຊເສດຖາ,  
ນະຄອນຫຼວງວຽງຈັນ, ສປປ ລາວ

(111) No. 61149

(180) 13/11/2033

(540) Registration



(511) 30

(210) No. 49261

(220) 13/11/2023

(732) ໂຮງງານປຸງແຕ່ງຊາທຽນຍີ ຈຳກັດຜູ້ດຽວ

ບ້ານ ໂພນແກ້ວ, ເມືອງ ຜົ້ງສາລີ, ແຂວງ ຜົ້ງສາລີ,  
ສປປ ລາວ

(111) No. 61150

(180) 13/11/2033

(540) Registration



(511) 09

(210) No. 49262

(220) 13/11/2023

(732) ບໍລິສັດ ຫົວຊີງ ອຸປະກອນເສີມດິຈິຕອນເອເລັກໂຕຣນິກ  
ຈຳກັດຜູ້ດຽວ

ບ້ານ ດົງປາລານທ່າ, ເມືອງ ສີສັດຕະນາກ,  
ນະຄອນຫຼວງວຽງຈັນ, ສປປ ລາວ

(111) No. 61151

(180) 13/11/2033

(540) Registration



(511) 09

(210) No. 49263

(220) 13/11/2023

(732) ບໍລິສັດ ຫົວຊີງ ອຸປະກອນເສີມດິຈິຕອນເອເລັກໂຕຣນິກ  
ຈຳກັດຜູ້ດຽວ

ບ້ານ ດົງປະລານທ່າ, ເມືອງ ສີສັດຕະນາກ,  
ນະຄອນຫຼວງວຽງຈັນ, ສປປ ລາວ

(111) No. 61152

(180) 13/11/2033

(540) Registration



(511) 30  
(210) No. 49268  
(220) 14/11/2023  
(732) ໂຮງງານ ປຸງແຕ່ງອາຫານ ຊິນຊິນ ຈຳກັດ  
ບ້ານ ໂພນສະຫວັນ, ເມືອງ ໄຊທານີ,  
ນະຄອນຫຼວງວຽງຈັນ, ສປປ ລາວ  
(111) No. 61153  
(180) 14/11/2033

(540) Registration



(511) 30  
(210) No. 49269  
(220) 14/11/2023  
(732) ໂຮງງານ ປຸງແຕ່ງອາຫານ ຊິນຊິນ ຈຳກັດ  
ບ້ານ ໂພນສະຫວັນ, ເມືອງ ໄຊທານີ,  
ນະຄອນຫຼວງວຽງຈັນ, ສປປ ລາວ  
(111) No. 61154  
(180) 14/11/2033



(540) Registration



(511) 30  
(210) No. 49270  
(220) 14/11/2023  
(732) ໂຮງງານ ປຸງແຕ່ງອາຫານ ຊິນຊິນ ຈຳກັດ  
ບ້ານ ໂພນສະຫວັນ, ເມືອງ ໄຊທານີ,  
ນະຄອນຫຼວງວຽງຈັນ, ສປປ ລາວ  
(111) No. 61155  
(180) 14/11/2033

(540) Registration



(511) 36  
(210) No. 49272  
(220) 14/11/2023  
(732) ໂຮງແຮມ ວັນດ້າ ວິສຕ້າ ນະຄອນຫຼວງວຽງຈັນ  
ຈຳກັດຜູ້ດຽວ  
ບ້ານ ຈອມມະນີ, ເມືອງ ໄຊເສດຖາ,  
ນະຄອນຫຼວງວຽງຈັນ, ສປປ ລາວ  
(111) No. 61156  
(180) 14/11/2033

(540) Registration



(511) 36

(210) No. 49273

(220) 14/11/2023

(732) ໂຮງແຮມ ວັນດ້າ ວິສຕ້າ ນະຄອນຫຼວງວຽງຈັນ

ຈຳກັດຜູ້ດຽວ

ບ້ານ ຈອມມະນີ, ເມືອງ ໄຊເສດຖາ,

ນະຄອນຫຼວງວຽງຈັນ, ສປປ ລາວ

(111) No. 61157

(180) 14/11/2033

(540) Registration



(511) 38

(210) No. 49275

(220) 15/11/2023

(732) ບໍລິສັດ ລາວໄອທີ ຊິສເຕັມ ນຳເຂົ້າ-ສົ່ງອອກ ຈຳກັດ

ບ້ານ ທາດຫຼວງໃຕ້, ເມືອງ ໄຊເສດຖາ,

ນະຄອນຫຼວງວຽງຈັນ, ສປປ ລາວ

(111) No. 61158

(180) 15/11/2033

(540) Registration



(511) 05

(210) No. 49277

(220) 15/11/2023

(732) ທ່ານ ສີທຸຍ ສີຈັນທອນ

ບ້ານ ໂພນສະຫວັນ, ນະຄອນໄກສອນພິມວິຫານ ແຂວງ

ສະຫວັນນະເຂດ, ສປປ ລາວ

(111) No. 61159

(180) 15/11/2033

(540) Registration



(511) 43

(210) No. 49281

(220) 15/11/2023

(732) ບໍລິສັດ ລາວ ຄິງ ສະຕາ ການລົງທຶນສາກົນ

ຈຳກັດຜູ້ດຽວ

(LAO KING STAR INTERATIONAL  
INVESTMENT SOLE CO.,LTD)

ບ້ານ ໜອງແຕ່ງ, ເມືອງ ສີໂຄດຕະບອງ,

ນະຄອນຫຼວງວຽງຈັນ, ສປປ ລາວ

(111) No. 61160

(180) 15/11/2033

(540) Registration



(511) 41

(210) No. 49282

(220) 15/11/2023

(732) ບໍລິສັດ ລາວ ຄົງ ສະຕາ ການລົງທຶນສາກົນ

ຈຳກັດຜູ້ດຽວ

(LAO KING STAR INTERATIONAL  
INVESTMENT SOLE CO.,LTD)

ບ້ານ ໜອງແຕ່ງ, ເມືອງ ສີໂຄດຕະບອງ,

ນະຄອນຫຼວງວຽງຈັນ, ສປປ ລາວ

(111) No. 61161

(180) 15/11/2033

(540) Registration



(511) 39

(210) No. 49283

(220) 15/11/2023

(732) ບໍລິສັດ ລາວ ຄົງ ສະຕາ ການລົງທຶນສາກົນ

ຈຳກັດຜູ້ດຽວ

(LAO KING STAR INTERATIONAL  
INVESTMENT SOLE CO.,LTD)

ບ້ານ ໜອງແຕ່ງ, ເມືອງ ສີໂຄດຕະບອງ,

ນະຄອນຫຼວງວຽງຈັນ, ສປປ ລາວ

(111) No. 61162

(180) 15/11/2033

(540) Registration



(511) 35

(210) No. 49284

(220) 15/11/2023

(732) ບໍລິສັດ ລາວ ຄົງ ສະຕາ ການລົງທຶນສາກົນ

ຈຳກັດຜູ້ດຽວ

(LAO KING STAR INTERATIONAL  
INVESTMENT SOLE CO.,LTD)

ບ້ານ ໜອງແຕ່ງ, ເມືອງ ສີໂຄດຕະບອງ,

ນະຄອນຫຼວງວຽງຈັນ, ສປປ ລາວ

(111) No. 61163

(180) 15/11/2033

(540) Registration



(511) 29

(210) No. 49285

(220) 15/11/2023

(732) ບໍລິສັດ ລາວ ຄົງ ສະຕາ ການລົງທຶນສາກົນ

ຈຳກັດຜູ້ດຽວ

(LAO KING STAR INTERATIONAL  
INVESTMENT SOLE CO.,LTD)

ບ້ານ ໜອງແຕ່ງ, ເມືອງ ສີໂຄດຕະບອງ,

ນະຄອນຫຼວງວຽງຈັນ, ສປປ ລາວ

(111) No. 61164

(180) 15/11/2033

(540) Registration



(511) 16

(210) No. 49286

(220) 15/11/2023

(732) ບໍລິສັດ ລາວ ຄົງ ສະຕາ ການລົງທຶນສາກົນ

ຈຳກັດຜູ້ດຽວ

(LAO KING STAR INTERATIONAL  
INVESTMENT SOLE CO.,LTD)

ບ້ານ ໜອງແຕ່ງ, ເມືອງ ສີໂຄດຕະບອງ,

ນະຄອນຫຼວງວຽງຈັນ, ສປປ ລາວ

(111) No. 61165

(180) 15/11/2033

(540) Registration



(511) 43

(210) No. 49287

(220) 15/11/2023

(732) ບໍລິສັດ ຄົງສະຕາວີຮີໂກ ຈຳກັດຜູ້ດຽວ

(KINGSTAR VEHICLE SOLE CO., LTD)

ບ້ານ ໄຜສີ, ເມືອງ ສີໂຄດຕະບອງ,

ນະຄອນຫຼວງວຽງຈັນ, ສປປ ລາວ

(111) No. 61166

(180) 15/11/2033

(540) Registration



(511) 41

(210) No. 49288

(220) 15/11/2023

(732) ບໍລິສັດ ຄົງສະຕາວີຮີໂກ ຈຳກັດຜູ້ດຽວ  
(KINGSTAR VEHICLE SOLE CO., LTD)  
ບ້ານ ໄພສີ, ເມືອງ ສີໂຄດຕະບອງ,  
ນະຄອນຫຼວງວຽງຈັນ, ສປປ ລາວ

(111) No. 61167

(180) 15/11/2033

(540) Registration



(511) 39

(210) No. 49289

(220) 15/11/2023

(732) ບໍລິສັດ ຄົງສະຕາວີຮີໂກ ຈຳກັດຜູ້ດຽວ  
(KINGSTAR VEHICLE SOLE CO., LTD)  
ບ້ານ ໄພສີ, ເມືອງ ສີໂຄດຕະບອງ,  
ນະຄອນຫຼວງວຽງຈັນ, ສປປ ລາວ

(111) No. 61168

(180) 15/11/2033

(540) Registration



(511) 31

(210) No. 49290

(220) 15/11/2023

(732) ບໍລິສັດ ຄົງສະຕາວີຮີໂກ ຈຳກັດຜູ້ດຽວ  
(KINGSTAR VEHICLE SOLE CO., LTD)  
ບ້ານ ໂພສີ, ເມືອງ ສີໂຄດຕະບອງ,  
ນະຄອນຫຼວງວຽງຈັນ, ສປປ ລາວ

(111) No. 61169

(180) 15/11/2033

(540) Registration



(511) 29

(210) No. 49291

(220) 15/11/2023

(732) ນະຄອນຫຼວງວຽງຈັນ, ສປປ ລາວ  
(KINGSTAR VEHICLE SOLE CO., LTD)  
ບ້ານ ໂພສີ, ເມືອງ ສີໂຄດຕະບອງ,  
ນະຄອນຫຼວງວຽງຈັນ, ສປປ ລາວ

(111) No. 61170

(180) 15/11/2033



(540) Registration



(511) 16

(210) No. 49292

(220) 15/11/2023

(732) ບໍລິສັດ ຄົງສະຕາວີຮີໂກ ຈຳກັດຜູ້ດຽວ  
(KINGSTAR VEHICLE SOLE CO., LTD)  
ບ້ານ ໄພສີ, ເມືອງ ສີໂຄດຕະບອງ,  
ນະຄອນຫຼວງວຽງຈັນ, ສປປ ລາວ

(111) No. 61171

(180) 15/11/2033

(540) Registration



(511) 43

(210) No. 49293

(220) 15/11/2023

(732) ບໍລິສັດ ອິມເຜີສຊັນ ເຊີນຕູ(ລາວ) ລົງທຶນ ອາຫານ ແລະ  
ເຄື່ອງດື່ມ ຈຳກັດ  
ບ້ານ ອຸບມຸງ, ເມືອງ ສີໂຄດຕະບອງ,  
ນະຄອນຫຼວງວຽງຈັນ, ສປປ ລາວ

(111) No. 61172

(180) 15/11/2033

(540) Registration



(511) 30

(210) No. 49294

(220) 16/11/2023

(732) ວິສາຫະກິດສ່ວນບຸກຄົນ ສະໂນໄອ້

ບ້ານທົ່ງພານທອງ, ເມືອງສີສັດຕະນາກ,

ນະຄອນຫຼວງວຽງຈັນ, ສປປ ລາວ

(111) No. 61173

(180) 16/11/2033

(540) Registration



(511) 43

(210) No. 49295

(220) 16/11/2023

(732) ວິສາຫະກິດສ່ວນບຸກຄົນ ສະໂນໄອ້

ບ້ານທົ່ງພານທອງ, ເມືອງສີສັດຕະນາກ,

ນະຄອນຫຼວງວຽງຈັນ, ສປປ ລາວ

(111) No. 61174

(180) 16/11/2033

(540) Registration



(511) 05

(210) No. 49298

(220) 17/11/2023

(732) ວິສາຫະກິດ ສ່ວນບຸກຄົນ ຮ້ານ ຄຸນທະວີ

ບ້ານ ທົ່ງກາງ, ເມືອງ ສີສັດຕະນາກ,

ນະຄອນຫຼວງວຽງຈັນ, ສປປ ລາວ

(111) No. 61177

(180) 17/11/2033

(540) Registration



(511) 03, 14, 25, 35, 39, 41 and 43

(210) No. 49299

(220) 17/11/2023

(732) ບໍລິສັດ ວາງແຜນ ສີບັນເທີງ ວັດທະນະທຳ ການລົງທຶນ

ຊື່ຢ່ວນ ຈຳກັດຜູ້ດຽວ

ບ້ານ ໜອງຈັນ, ເມືອງ ສີສັດຕະນາກ,

ນະຄອນຫຼວງວຽງຈັນ, ສປປ ລາວ

(111) No. 61178

(180) 17/11/2033

(540) Registration



(511) 36  
(210) No. 49300  
(220) 17/11/2023  
(732) ບໍລິສັດ ບິດຊແລນດໍອດລາ ຈຳກັດຜູ້ດຽວ  
ບ້ານ ໂຊກໃຫຍ່, ເມືອງ ໄຊເສດຖາ,  
ນະຄອນຫຼວງວຽງຈັນ, ສປປ ລາວ  
(111) No. 61179  
(180) 17/11/2033

(540) Registration



(511) 35  
(210) No. 49301  
(220) 17/11/2023  
(732) ບໍລິສັດ ຊີມໍ ຈຳກັດຜູ້ດຽວ  
ບ້ານ ໂຊກໃຫຍ່, ເມືອງ ໄຊເສດຖາ,  
ນະຄອນຫຼວງວຽງຈັນ, ສປປ ລາວ  
(111) No. 61180  
(180) 17/11/2033

(540) Registration



(511) 33

(210) No. 49302

(220) 17/11/2023

(732) ທ່ານ ພວງ ຟອງສິມບັດ

ບ້ານ ນາເຕີຍ, ເມືອງ ຈໍາພອນ,

ແຂວງ ສະຫວັນນະເຂດ, ສປປ ລາວ

(111) No. 61181

(180) 17/11/2033

(540) Registration



(511) 29

(210) No. 49231

(220) 06/11/2023

(732) Heritage Snacks & Food Co., Ltd.

34/1 - 34/2 Moo 5, Putthamonthon Sai 4

Road, Kratumlom, Sampran, Nakornpathom

73220, Thailand

(111) No. 61212

(180) 20/09/2034

(540) Registration

Formula B

(511) 12

(210) No. 49296

(220) 16/11/2023

(732) BYD COMPANY LIMITED

No.1, Yan'an Road, Kuichong Street, Dapeng  
New District, Shenzhen, China

(111) No. 61213

(180) 20/09/2034

(540) Registration

Formula B

(511) 37

(210) No. 49297

(220) 16/11/2023

(732) BYD COMPANY LIMITED

No.1, Yan'an Road, Kuichong Street, Dapeng  
New District, Shenzhen, China

(111) No. 61214

(180) 20/09/2034

(540) Registration



(511) 03 and 05

(210) No. 49338

(220) 21/11/2023

(732) PT SAYAP MAS UTAMA

Jl. Tipar Cakung Kav F 5-7 Cakung Barat,  
Cakung, Kota Adm. Jakarta Timur, Provinsi  
DKI Jakarta, Indonesia

(111) No. 61300

(180) 02/10/2034

(540) Registration



(511) 03 and 05

(210) No. 49339

(220) 21/11/2023

(732) PT SAYAP MAS UTAMA

Jl. Tipar Cakung Kav F 5-7 Cakung Barat,  
Cakung, Kota Adm. Jakarta Timur, Provinsi  
DKI Jakarta, Indonesia

(111) No. 61301

(180) 02/10/2034

(540) Registration

**ACTIVEGUARD**

(511) 03 and 05

(210) No. 49344

(220) 23/11/2023

(732) PT SAYAP MAS UTAMA

Jl. Tipar Cakung Kav F 5-7 Cakung Barat,  
Cakung, Kota Adm. Jakarta Timur, Provinsi  
DKI Jakarta, Indonesia

(111) No. 61302

(180) 02/10/2034

(540) Registration

**DAIA SMART**

(511) 03

(210) No. 49345

(220) 23/11/2023

(732) PT SAYAP MAS UTAMA

Jl. Tipar Cakung Kav F 5-7 Cakung Barat,  
Cakung, Kota Adm. Jakarta Timur, Provinsi  
DKI Jakarta, Indonesia

(111) No. 61303

(180) 02/10/2034



(540) Registration

**DAIA SOFTERGENT**

(511) 03

(210) No. 49346

(220) 23/11/2023

(732) PT SAYAP MAS UTAMA

Jl. Tipar Cakung Kav F 5-7 Cakung Barat,  
Cakung, Kota Adm. Jakarta Timur, Provinsi  
DKI Jakarta, Indonesia

(111) No. 61304

(180) 02/10/2034

(540) Registration

**GOLDA**

(511) 30

(210) No. 49347

(220) 23/11/2023

(732) PT SAYAP MAS UTAMA

Jl. Tipar Cakung Kav F 5-7 Cakung Barat,  
Cakung, Kota Adm. Jakarta Timur, Provinsi  
DKI Jakarta, Indonesia

(111) No. 61305

(180) 02/10/2034

(540) Registration

**NEO**

(511) 30

(210) No. 49348

(220) 23/11/2023

(732) PT SAYAP MAS UTAMA

Jl. Tipar Cakung Kav F 5-7 Cakung Barat,  
Cakung, Kota Adm. Jakarta Timur, Provinsi  
DKI Jakarta, Indonesia

(111) No. 61306

(180) 02/10/2034

(540) Registration

**NUVO**

(511) 05

(210) No. 49349

(220) 23/11/2023

(732) PT SAYAP MAS UTAMA

Jl. Tipar Cakung Kav F 5-7 Cakung Barat,  
Cakung, Kota Adm. Jakarta Timur, Provinsi  
DKI Jakarta, Indonesia

(111) No. 61307

(180) 02/10/2034

(540) Registration

**BABY HAPPY**

(511) 05

(210) No. 49350

(220) 23/11/2023

(732) PT MULTI DUTA UTARI

JL. DRIYOREJO KM 23, Desa/Kelurahan

Driyorejo, Kec. Driyorejo, Kab. Gresik,

Provinsi Jawa Timur, Indonesia

(111) No. 61308

(180) 02/10/2034

(540) Registration

**HERS PROTEX**

(511) 05

(210) No. 49351

(220) 23/11/2023

(732) PT MULTI DUTA UTARI

JL. DRIYOREJO KM 23, Desa/Kelurahan

Driyorejo, Kec. Driyorejo, Kab. Gresik,

Provinsi Jawa Timur, Indonesia

(111) No. 61309

(180) 02/10/2034

(540) Registration

**JAVANA**

(511) 30

(210) No. 49352

(220) 23/11/2023

(732) PT WINGS SURYA

Jl. Kalisosok Kidul No. 02, Desa/Kelurahan

Krempangan Selatan, Kec. Krempangan, Kota

Surabaya, Provinsi Jawa Timur, Indonesia

(111) No. 61310

(180) 02/10/2034

(540) Registration

**SUPERSOL**

(511) 05

(210) No. 49353

(220) 23/11/2023

(732) PT WINGS SURYA

Jl. Kalisosok Kidul No. 02, Desa/Kelurahan

Krempangan Selatan, Kec. Krempangan, Kota

Surabaya, Provinsi Jawa Timur, Indonesia

(111) No. 61311

(180) 02/10/2034

(540) Registration

**WINGS SOLVE**

(511) 03

(210) No. 49355

(220) 23/11/2023

(732) PT WINGS SURYA

Jl. Kalisosok Kidul No. 02, Desa/Kelurahan

Krempangan Selatan, Kec. Krempangan, Kota

Surabaya, Provinsi Jawa Timur, Indonesia

(111) No. 61312

(180) 02/10/2034

(540) Registration

**BJC**  
*Hygienist*

(511) 16

(210) No. 49394

(220) 27/11/2023

(732) Berli Jucker Public Company Limited

99 Soi Rubia, Sukhumvit 42 Road,

Phrakanong Sub-district, Klongtoey District,

Bangkok, 10110, Thailand

(111) No. 61313

(180) 27/11/2033

(540) Registration

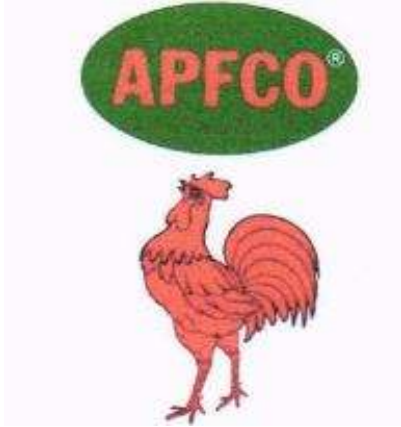

(511) 30

(210) No. 49320

(220) 20/11/2023

(732) ບໍລິສັດ ປຸງແຕ່ງແປ້ງມັນຕົ້ນ ອັດຕະປື ຈຳກັດຜູ້ດຽວ  
ບ້ານ ໃຫຍ່ໜຶ່ງຫົວເມືອງ, ເມືອງ ສາມັກຄີໄຊ,  
ແຂວງ ອັດຕະປື, ສປປ ລາວ

(111) No. 61314

(180) 20/11/2033

(540) Registration



(511) 32

(210) No. 49321

(220) 20/11/2023

(732) ທ່ານ ນາງ ມຸວຽງ ສຸກກະເສີນ  
ບ້ານ ດ່ານ, ເມືອງ ລະມາມ, ແຂວງ ເຊກອງ,  
ສປປ ລາວ

(111) No. 61315

(180) 20/11/2033

(540) Registration



(511) 35 and 37

(210) No. 49360

(220) 24/11/2023

(732) ບໍລິສັດ ລາວຊິນເທິເຫຼັກກ້າ ແລະ ພັດທະນາບໍ່ແຮ່ ຈຳກັດ

ບ້ານ ພະຂາວ, ເມືອງ ໄຊທານີ,

ນະຄອນຫຼວງວຽງຈັນ, ສປປ ລາວ

(111) No. 61316

(180) 24/11/2033

(540) Registration



(511) 30 and 35

(210) No. 49400

(220) 28/11/2023

(732) ບໍລິສັດ ສາກົນ ມະນີ ຈຳກັດ

ບ້ານ ໄຊສະຫວ່າງ, ເມືອງ ໄຊທານີ,

ນະຄອນຫຼວງວຽງຈັນ, ສປປ ລາວ

(111) No. 61317

(180) 28/11/2033

**ພາກທີ III**  
**(Part III)**  
**ເຄື່ອງໝາຍການຄ້າ**  
**Trademarks**

**3. ການຕໍ່ອາຍຸ**  
**(Renewal)**

**ຄຳອະທິບາຍກ່ຽວກັບລະຫັດຫຍໍ້**  
**(Introduction of Codes)**

- (540) ເຄື່ອງໝາຍການຄ້າ (Trademark)
- (511) ໝວດ (Nice Classification)
- (210) ເລກທີ ຄຳຮ້ອງ (Number of the application)
- (220) ວັນທີ ຄຳຮ້ອງ (Date of filing of the application)
- (732) ຊື່ ແລະ ທີ່ຢູ່ ຂອງຜູ້ຍື່ນຄຳຮ້ອງ (Name and Address of applicant)
- (111) ເລກທີການຈັດທະບຽນເຄື່ອງໝາຍການຄ້າ (Number of the registration)
- (180) ການຕໍ່ອາຍຸການຈັດທະບຽນ (Expiration date of the renewal)



(540) Trademark Renewal

**J & B**

(511) 33

(210) No. 1654

(220) 09/11/1992

(732) Diageo Brands B.V.

Molenworf 10-12, 1014 BG Amsterdam,

The Netherlands

(111) No. 1670

(180) 09/11/2032

(540) Trademark Renewal

**BAILEYS**

(511) 33

(210) No. 1665

(220) 16/11/1992

(732) R & A BAILEY & CO. and R& A BAILEY &

CO.,

NAAS ROAD, DUBLIN 12,, Ireland and

Nangor House, Western Estate, Dublin 8,

Ireland

(111) No. 1672

(180) 16/11/2032

(540) Trademark Renewal

**GILBEYS**

(511) 33

(210) No. 1694

(220) 14/12/1992

(732) DIAGEO BRANDS B.V

Molenwerf 10-12, 1014 BG Amsterdam,  
The Netherlands

(111) No. 1688

(180) 14/12/2032

(540) Trademark Renewal

**KODAK**

(511) 02, 09, 16, 22, 23, 35, 36, 40 and 42

(210) No. 2121

(220) 03/06/1993

(732) EASTMAN KODAK COMPANY

343 State Street, Rochester, New York 14650,  
United States of America

(111) No. 1957

(180) 03/06/2053

(540) Trademark Renewal

**KODAK**

(511) 02, 09, 16, 22, 23, 35, 36, 40 and 42

(210) No. 2121

(220) 03/06/1993

(732) EASTMAN KODAK COMPANY

343 State Street, Rochester, New York 14650,

United States of America

(111) No. 1957

(180) 03/06/2043

(540) Trademark Renewal

**KODAK**

(511) 02, 09, 16, 22, 23, 35, 36, 40 and 42

(210) No. 2121

(220) 03/06/1993

(732) EASTMAN KODAK COMPANY

343 State Street, Rochester, New York 14650,

United States of America

(111) No. 1957

(180) 03/06/2033

(540) Trademark Renewal

**EKTAR**

(511) 01

(210) No. 2129

(220) 03/06/1993

(732) EASTMAN KODAK COMPANY

343 State Street Rochester, New York 14650,

United States Of America

(111) No. 1965

(180) 03/06/2033

(540) Trademark Renewal

**LOVABLE**

(511) 25

(210) No. 2200

(220) 03/06/1993

(732) DBI IP Europe SARL

33, Rue du Puits Romain, Bertrange,

Luxembourg L-8070, Luxembourg

(111) No. 2036

(180) 03/06/2033

(540) Trademark Renewal

**COMPAQ**

(511) 09

(210) No. 2897

(220) 28/03/1994

(732) HEWLETT-PACKARD DEVELOPMENT  
COMPANY, L.P.

11445 Compaq Center Drive West Houston,  
Texas 77070, United States of America.

(111) No. 2288

(180) 28/03/2034

(540) Trademark Renewal

**PROLIANT**

(511) 09

(210) No. 2908

(220) 28/03/1994

(732) HEWLETT PACKARD ENTERPRISE  
DEVELOPMENT LP

1701 East Mossy Oaks Road, Spring, TX,  
77389, United States of America

(111) No. 2299

(180) 28/03/2034

(540) Trademark Renewal

**PRESARIO**

(511) 09

(210) No. 2910

(220) 28/03/1994

(732) HEWLETT-PACKARD DEVELOPMENT  
COMPANY, L.P.

11445 Compaq Center Drive West, Houston,  
TX 77070, United States of America

(111) No. 2301

(180) 28/03/2034

(540) Trademark Renewal

**MAX FACFOR**

(511) 03

(210) No. 2437

(220) 27/08/1993

(732) Noxell Corporation

11050 York Road, Hunt Valley, Maryland  
21030-2098, United States of America

(111) No. 2352

(180) 27/08/2033

(540) Trademark Renewal

**HUGO BOSS**

(511) 03

(210) No. 2476

(220) 27/08/1993

(732) HUGO BOSS Trade Mark Management GmbH  
& Co., KG

Dieselstrasse 12, 72555, Metzingen, Germany

(111) No. 2440

(180) 27/08/2033

(540) Trademark Renewal

**PINKERTON**

(511) 42

(210) No. 3054

(220) 03/06/1993

(732) PINKERTON'S, LLC

4330 Park Terrace Drive, Westlake Village,  
CA 91361, United States of America

(111) No. 2498

(180) 03/06/2034

(540) Trademark Renewal

**PINKERTON and  
Device**

(511) 42

(210) No. 3055

(220) 03/06/1993

(732) PINKERTON'S INC

4330 Park Terrace Drive, Westlake Village,  
CA 91361, United States of America

(111) No. 2499

(180) 03/06/2034

(540) Trademark Renewal



(511) 29, 30 and 32

(210) No. 2748

(220) 03/03/1994

(732) SHANGHAI GUAN SHENG YUAN FOOD

LTD

NO. 220 CAO BAO ROAD, SHANGHAI,  
CHINA

(111) No. 2541

(180) 03/03/2034



(540) Trademark Renewal



(511) 29, 30 and 32

(210) No. 2749

(220) 03/03/1994

(732) SHANGHAI GUAN SHENG YUAN FOOD  
LTD

NO. 220 CAO BAO ROAD, SHANGHAI,  
CHINA

(111) No. 2542

(180) 03/03/2034

(540) Trademark Renewal

**ALLIED**

(511) 39

(210) No. 2751

(220) 03/03/1994

(732) Allied Van Lines, Inc.

101 E. Washi ngton Blvd., Suite 1100, Fort  
Wayne, Indiana 46802,  
United States of America

(111) No. 2544

(180) 03/03/2034

(540) Trademark Renewal



(511) 03

(210) No. 2756

(220) 03/03/1994

(732) Mr. Dome Ruengsomboon and Mr. Chet Chamnitiravanich

625/150 Rama 2, Bangmod sub-District,

Jomthong District, Bangkok 10150, Thailand

8 Soi 94 Rama 2 Road, Samaedum,

Bangkhunthien, Bangkok 10150, Thailand,

28/02 Moo 5, Soi Ruampalng, Rama II Road,

Chomtong District, Bangkok 10150, Thailand

(111) No. 2549

(180) 03/03/2034

(540) Trademark Renewal

**AMBERLITE**

(511) 01

(210) No. 2774

(220) 04/03/1994

(732) ROHM AND HAAS COMPANY

100 Independence Mall West, Philadelphia,

P.A. 19105, United States of America

(111) No. 2601

(180) 04/03/2034

(540) Trademark Renewal

**PALMER'S**

(511) 03

(210) No. 2782

(220) 04/03/1994

(732) E.T. BROWNE DRUG CO., INC.

440 Sylvan Avenue, Englewood Cliffs, New  
Jersey 07632, United States of America

(111) No. 2604

(180) 10/03/2034

(540) Trademark Renewal

**COCOA BUTTER  
FORMULA**

(511) 03

(210) No. 2784

(220) 04/03/1994

(732) E.T. BROWNE DRUG CO., INC.

440 Sylvan Avenue, Englewood Cliffs, NJ  
07632, New jersey, United States of America

(111) No. 2606

(180) 10/03/2034

(540) Trademark Renewal

**SKIN SUCCESS**

(511) 03

(210) No. 2785

(220) 04/03/1994

(732) E.T. BROWNE DRUG CO., INC.

440 Sylvan Avenue, Englewood Cliffs, New  
Jersey 07632, United States of America

(111) No. 2607

(180) 04/03/2034

(540) Trademark Renewal



(511) 09 and 25

(210) No. 2789

(220) 04/03/1994

(732) WARNER BROS. ENTERTAINMENT INC.

4000 Warner Blvd, Burbank, California  
91522, United States of America

(111) No. 2611

(180) 04/03/2034

(540) Trademark Renewal



(511) 09

(210) No. 2790

(220) 04/03/1994

(732) WARNER BROS. ENTERTAINMENT INC.

4000 Warner Blvd, Burbank, California

91522, United States of America

(111) No. 2612

(180) 04/03/2034

(540) Trademark Renewal



(511) 09

(210) No. 2791

(220) 04/03/1994

(732) WARNER BROS. ENTERTAINMENT INC.

4000 Warner Boulevard, Burbank, California

91522, United States of America

(111) No. 2613

(180) 04/03/2034

(540) Trademark Renewal



(511) 09

(210) No. 2792

(220) 04/03/1994

(732) Warner Records Inc.

777 South Santa Fe Avenue, Los Angeles,  
CA 90021, United States of America

(111) No. 2614

(180) 04/03/2034

(540) Trademark Renewal

**UPS**

(511) 16, 38 and 39

(210) No. 2794

(220) 04/03/1994

(732) UNITED PARCEL SERVICE OF AMERICA,

INC

55 Glenlake Parkway, NE, Atlanta, Georgia  
30328, United States of America

(111) No. 2616

(180) 04/03/2054

(540) Trademark Renewal

**UPS**

(511) 16, 38 and 39

(210) No. 2794

(220) 04/03/1994

(732) UNITED PARCEL SERVICE OF AMERICA,  
INC

, 55 Glenlake Parkway, NE, Atlanta, Georgia  
30328, United States of America

(111) No. 2616

(180) 04/03/2044

(540) Trademark Renewal

**UPS**

(511) 16, 38 and 39

(210) No. 2794

(220) 04/03/1994

(732) UNITED PARCEL SERVICE OF AMERICA,  
INC

, 55 Glenlake Parkway, NE, Atlanta, Georgia  
30328, United States of America

(111) No. 2616

(180) 04/03/2034

(540) Trademark Renewal



(511) 16, 38 and 39

(210) No. 2795

(220) 04/03/1994

(732) UNITED PARCEL SERVICE OF  
AMERICA, INC

55 Glenlake Parkway, NE, Atlanta, Georgia  
30328, United States of America

(111) No. 2617

(180) 04/03/2034

(540) Trademark Renewal



(511) 16, 38 and 39

(210) No. 2795

(220) 04/03/1994

(732) UNITED PARCEL SERVICE OF  
AMERICA, INC

55 Glenlake Parkway, NE, Atlanta, Georgia  
30328, United States of America

(111) No. 2617

(180) 04/03/2044



(540) Trademark Renewal

**UNITED PARCEL  
SERVICE**

(511) 16, 38 and 39

(210) No. 2796

(220) 04/03/1994

(732) UNITED PARCEL SERVICE OF AMERICA,  
INC

55 Glenlake Parkway, NE, Atlanta, Georgia  
30328, United States of America

(111) No. 2618

(180) 04/03/2054

(540) Trademark Renewal

**UNITED PARCEL  
SERVICE**

(511) 16, 38 and 39

(210) No. 2796

(220) 04/03/1994

(732) UNITED PARCEL SERVICE OF AMERICA,  
INC

55 Glenlake Parkway, NE, Atlanta, Georgia  
30328, United States of America

(111) No. 2618

(180) 04/03/2044

(540) Trademark Renewal

**UNITED PARCEL  
SERVICE**

(511) 16, 38 and 39

(210) No. 2796

(220) 04/03/1994

(732) UNITED PARCEL SERVICE OF AMERICA,  
INC

55 Glenlake Parkway, NE, Atlanta, Georgia  
30328, United States of America

(111) No. 2618

(180) 04/03/2034

(540) Trademark Renewal

**POWERADE**

(511) 32

(210) No. 2691

(220) 03/03/1994

(732) THE COCA-COLA COMPANY

310 North Avenue, N.W. City of Alanta, State  
of Georgia 30313, United States of America

(111) No. 2653

(180) 03/03/2034

(540) Trademark Renewal



(511) 34

(210) No. 2700

(220) 03/03/1994

(732) Philip Morris Brands Sàrl

Quai Jeanrenaud 3, 2000 Neuchâtel,

Switzerland

(111) No. 2662

(180) 03/03/2034

(540) Trademark Renewal

**TAMPICO**

(511) 32

(210) No. 2690

(220) 03/03/1994

(732) TAMPICO BEVERAGES, INC.

3106 North Campbell Avenue, Chicago,

Illinois 60618, United States of America

(111) No. 2663

(180) 03/03/2034

(540) Trademark Renewal



(511) 34

(210) No. 3215

(220) 01/09/1994

(732) PT Sumatra Tobacco Trading Company  
Jalan Pattimura No. 3, Pematang Siantar,  
Sumatera Utara, Indonesia

(111) No. 2714

(180) 01/09/2034

(540) Trademark Renewal



(511) 34

(210) No. 3217

(220) 01/09/1994

(732) PT Sumatra Tobacco Trading Company  
Jalan Pattimura No. 3, Pematang Siantar,  
Sumatera Utara, Indonesia

(111) No. 2716

(180) 01/09/2034

(540) Trademark Renewal

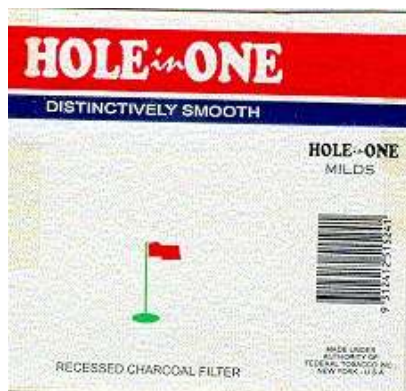

(511) 34

(210) No. 3224

(220) 01/09/1994

(732) PT Sumatra Tobacco Trading Company  
Jalan Pattimura No. 3, Pematang Siantar,  
Sumatera Utara, Indonesia

(111) No. 2721

(180) 01/09/2034

(540) Trademark Renewal

**KAO**

(511) 01, 03, 05, 09, 16 and 21

(210) No. 2845

(220) 21/03/1994

(732) Kao Kabushiki Kaisha ( also trading as Kao  
Corporation)  
14-10, Nihonbashi, Kayabacho 1-chome,  
Chuo-ku, Tokyo, Japan

(111) No. 2742

(180) 21/03/2034

(540) Trademark Renewal



(511) 01, 03, 05, 09, 16 and 21

(210) No. 2846

(220) 21/03/1994

(732) Kao Kabushiki Kaisha ( also trading as Kao Corporation)

14-10, Nihonbashi, Kayabacho 1-chome,  
Chuo-ku, Tokyo, Japan

(111) No. 2743

(180) 21/03/2034

(540) Trademark Renewal

**FEATHER**

(511) 03

(210) No. 2848

(220) 21/03/1994

(732) Kao Kabushiki Kaisha ( also trading as Kao Corporation)

14-10, Nihonbashi, Kayabacho 1-chome,  
Chuo-ku, Tokyo, Japan

(111) No. 2745

(180) 21/03/2034

(540) Trademark Renewal

**SIFONE**

(511) 03

(210) No. 2849

(220) 21/03/1994

(732) Kao Kabushiki Kaisha ( also trading as Kao Corporation)

14-10, Nihonbashi, Kayabacho 1-chome,  
Chuo-ku, Tokyo, Japan

(111) No. 2746

(180) 21/03/2034

(540) Trademark Renewal

**MERIT**

(511) 03

(210) No. 2852

(220) 21/03/1994

(732) Kao Kabushiki Kaisha ( also trading as Kao Corporation)

14-10, Nihonbashi, Kayabacho 1-chome,  
Chuo-ku, Tokyo, Japan

(111) No. 2749

(180) 21/03/2034

(540) Trademark Renewal



(511) 09, 16, 25, 38 and 41

(210) No. 2881

(220) 21/03/1994

(732) VIACOM INTERNATIONAL INC.

1515 Broadway, New York, NY 10036,

United States of America

(111) No. 2773

(180) 21/03/2034

(540) Trademark Renewal

**EXXON**

(511) 01

(210) No. 2701

(220) 03/03/1994

(732) Exxon Mobil Corporation

22777 Springwoods Village Parkway, Spring,

TX 77389, United States of America

(111) No. 2807

(180) 03/03/2034



(540) Trademark Renewal

**EXXON**

(511) 04

(210) No. 2702

(220) 03/03/1994

(732) Exxon Mobil Corporation

22777 Springwoods Village Parkway, Spring,  
TX 77389, United States of America

(111) No. 2808

(180) 03/03/2034

(540) Trademark Renewal

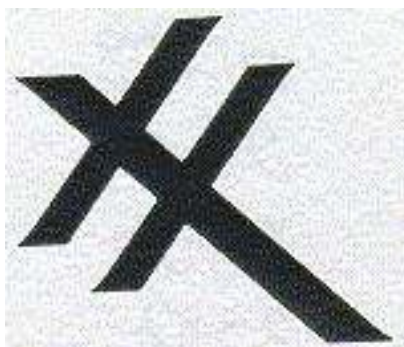

(511) 01

(210) No. 2705

(220) 03/03/1994

(732) Exxon Mobil Corporation

22777 Springwoods Village Parkway, Spring,  
TX 77389, United States of America

(111) No. 2811

(180) 03/03/2044

(540) Trademark Renewal



(511) 04

(210) No. 2706

(220) 03/03/1994

(732) Exxon Mobil Corporation

22777 Springwoods Village Parkway, Spring,  
TX 77389, United States of America

(111) No. 2812

(180) 03/03/2034

(540) Trademark Renewal

**ESSO**

(511) 01

(210) No. 2709

(220) 03/03/1994

(732) Exxon Mobil Corporation

22777 Springwoods Village Parkway, Spring,  
TX 77389, United States of America

(111) No. 2815

(180) 03/03/2034

(540) Trademark Renewal

**ESSO**

(511) 04

(210) No. 2710

(220) 03/03/1994

(732) Exxon Mobil Corporation

22777 Springwoods Village Parkway, Spring,  
TX 77389, United States of America

(111) No. 2816

(180) 03/03/2034

(540) Trademark Renewal



(511) 04

(210) No. 2714

(220) 03/03/1994

(732) Exxon Mobil Corporation

22777 Springwoods Village Parkway, Spring,  
TX 77389, United States of America

(111) No. 2820

(180) 03/03/2034

(540) Trademark Renewal

**HACKS**

(511) 30

(210) No. 2962

(220) 22/04/1994

(732) INTER POPULAR COMPANY LIMITED

417/27-28, Aroon Amarint Road, Tambol  
Bangyeekan, Khet Bangkok-noi, Bangkok,  
Thailand

(111) No. 2833

(180) 22/04/2034

(540) Trademark Renewal

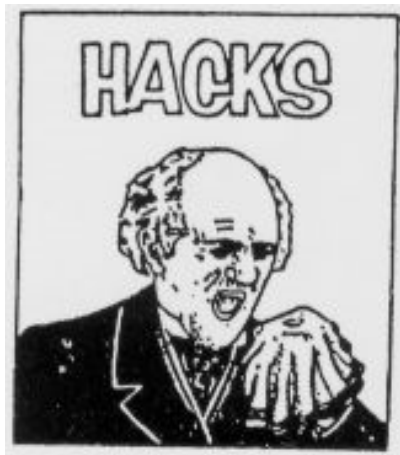

(511) 05

(210) No. 2963

(220) 22/04/1994

(732) Inter Popular Company Limited

417/27-28, Aroon Amarint Road, Tambol  
Bangyeekan, Khet Bangkok-noi, Bangkok,  
Thailand

(111) No. 2834

(180) 22/04/2034

(540) Trademark Renewal



(511) 30

(210) No. 2964

(220) 22/04/1994

(732) Inter Popular Company Limited

417/27-28, Aroon Amarint Road, Tambol  
Bangyeekan, Khet Bangkok-noi, Bangkok,  
Thailand

(111) No. 2835

(180) 22/04/2034

(540) Trademark Renewal

**DUOLITE**

(511) 01

(210) No. 2974

(220) 22/04/1994

(732) ROHM AND HAAS COMPANY

100 Independence Mall West, Philadelphia,  
P.A. 19105, United States of America

(111) No. 2845

(180) 22/04/2034

(540) Trademark Renewal

**AMBERSEP**

(511) 01

(210) No. 2975

(220) 22/04/1994

(732) ROHM AND HAAS COMPANY

100 Independence Mall West, Philadelphia,  
Pennsylvania 19106-2399,  
United States of America

(111) No. 2846

(180) 22/04/2034

(540) Trademark Renewal



(511) 01

(210) No. 3313

(220) 20/09/1994

(732) ALTECO CHEMICAL PTE. LTD.

19, Tuas Avenue 11, Singapore 639084,  
Singapore

(111) No. 2851

(180) 20/09/2034

(540) Trademark Renewal



(511) 16

(210) No. 3314

(220) 20/09/1994

(732) ALTECO CHEMICAL PTE. LTD.

19, Tuas Avenue 11, Singapore 639084,

Singapore

(111) No. 2852

(180) 20/09/2034

(540) Trademark Renewal

**ALTECO**

(511) 01

(210) No. 3315

(220) 20/09/1994

(732) ALTECO CHEMICAL PTE. LTD.

19, Tuas Avenue 11, Singapore 639084,

Singapore

(111) No. 2853

(180) 20/09/2034

(540) Trademark Renewal

**ALTECO**

(511) 16

(210) No. 3316

(220) 20/09/1994

(732) ALTECO CHEMICAL PTE. LTD.

19, Tuas Avenue 11, Singapore 639084,  
Singapore

(111) No. 2854

(180) 20/09/2034

(540) Trademark Renewal



(511) 01

(210) No. 3317

(220) 20/09/1994

(732) ALTECO CHEMICAL PTE. LTD.

19, Tuas Avenue 11, Singapore 639084,  
Singapore

(111) No. 2855

(180) 20/09/2034



(540) Trademark Renewal



(511) 16

(210) No. 3318

(220) 20/09/1994

(732) ALTECO CHEMICAL PTE. LTD.

19, Tuas Avenue 11, Singapore 639084,  
Singapore

(111) No. 2856

(180) 20/09/2034

(540) Trademark Renewal



**ELEPHANT Device**

(511) 01

(210) No. 3319

(220) 20/09/1994

(732) ALTECO CHEMICAL PTE. LTD.

19, Tuas Avenue 11, Singapore 639084,  
Singapore

(111) No. 2857

(180) 20/09/2034

(540) Trademark Renewal

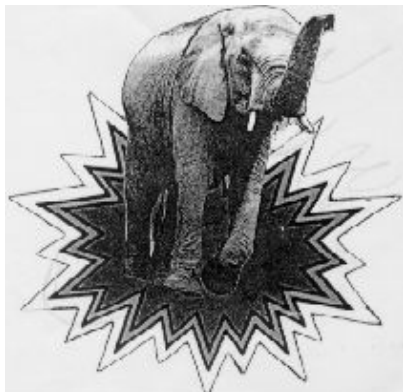

(511) 16  
(210) No. 3320  
(220) 20/09/1994  
(732) ALTECO CHEMICAL PTE. LTD.  
19, Tuas Avenue 11, Singapore 639084,  
Singapore  
(111) No. 2858  
(180) 20/09/2034

(540) Trademark Renewal



(511) 01  
(210) No. 3321  
(220) 20/09/1994  
(732) ALTECO CHEMICAL PTE. LTD.  
19, Tuas Avenue 11, Singapore 639084,  
Singapore  
(111) No. 2859  
(180) 20/09/2034

(540) Trademark Renewal



(511) 16

(210) No. 3322

(220) 20/09/1994

(732) ALTECO CHEMICAL PTE. LTD.

19, Tuas Avenue 11, Singapore 639084,

Singapore

(111) No. 2860

(180) 20/09/2034

(540) Trademark Renewal



(511) 14

(210) No. 3129

(220) 01/07/1994

(732) LACOSTE

31-37, boulevard de Montmorency 75016

Paris, France

(111) No. 2861

(180) 01/07/2034

(540) Trademark Renewal



(511) 32

(210) No. 2679

(220) 29/12/1993

(732) GIE CRISTALINE

70 Avenue des Sources, 03270 SAINT-  
YORRE, FRANCE

(111) No. 2872

(180) 29/12/2033

(540) Trademark Renewal



(511) 03

(210) No. 2797

(220) 09/03/1994

(732) ESPRIT INTERNATIONAL

1370 Broadway, New York, New York ,  
United States of America

(111) No. 2882

(180) 09/03/2034

(540) Trademark Renewal



(511) 39

(210) No. 2798

(220) 09/03/1994

(732) DHL INTERNATIONAL GMBH.

Charles-de-Gaulle-Strasse20, 53113 Bonn,  
Germany

(111) No. 2883

(180) 09/03/2034

(540) Trademark Renewal

**CAPSTAN**

(511) 34

(210) No. 2808

(220) 09/03/1994

(732) British American Tobacco (Brands) Limited

Globe House, 4 Temple Place, London WC2R  
2 PG, United Kingdom

(111) No. 2893

(180) 09/03/2034

(540) Trademark Renewal

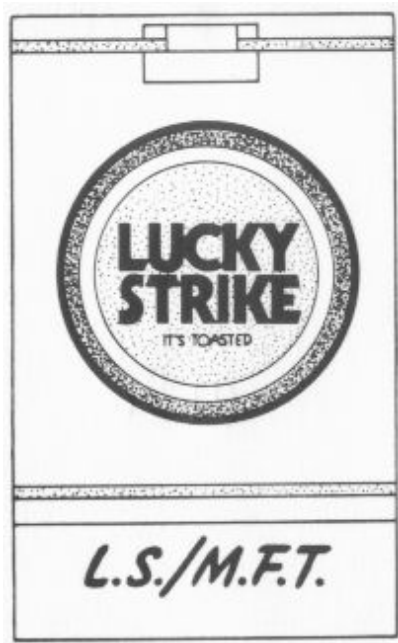

(511) 34

(210) No. 2810

(220) 09/03/1994

(732) British American Tobacco (Brands) Inc.  
2711 Centerville Road, Suite 300,  
Wilmington, Delaware 19808,  
United States of America

(111) No. 2895

(180) 09/03/2034

(540) Trademark Renewal

**IRIDIUM**

(511) 09 and 38

(210) No. 2819

(220) 09/03/1994

(732) Iridium Satellite LLC  
1750 Tysons Boulevard, Suite 1400, McLean,  
Virginia 22102, United States of America

(111) No. 2904

(180) 09/03/2034

(540) Trademark Renewal

**PIPER-HEIDSIECK**

(511) 33

(210) No. 2920

(220) 29/03/1994

(732) COMPAGNIE CHAMPENOISE PH-CH.

PIPER HEIDSIECK-ANCIENNE MAISON

HEIDSIECK FONDÉE EN 1785

12 Allée du Vignoble 51100 Reims, France

(111) No. 2917

(180) 29/03/2034

(540) Trademark Renewal

**Q & Q**

(511) 14

(210) No. 2951

(220) 18/04/1994

(732) Citizen Tokei Kabushiki Kaisha also trading as

Citizen Watch Co., Ltd.

1-12, 6-chome, Tanashi-cho, Nishi-tokyo-shi,

Tokyo, Japan

(111) No. 2923

(180) 18/04/2034

(540) Trademark Renewal



(511) 31

(210) No. 2952

(220) 18/04/1994

(732) DINDINGS POULTRY DEVELOPMENT  
CENTRE SDN. BHD.

Kampung Aceh Industrial Estate, 32000  
Sitiawan, Perak Darul Ridzuan, Malaysia

(111) No. 2924

(180) 18/04/2034

(540) Trademark Renewal

**Shachihata**

(511) 16

(210) No. 2981

(220) 25/04/1994

(732) SHACHIHATA INC.

No. 69, 4-Chome, Amatsuka-cho, Nishi-ku,  
Nagoya, Japan

(111) No. 2928

(180) 25/04/2034



(540) Trademark Renewal

**Artline**

(511) 16

(210) No. 2982

(220) 25/04/1994

(732) SHACHIHA TA INC

No. 69, 4-Chome, Amatsuka-cho, Nishi-ku,  
Nagoya, Japan

(111) No. 2929

(180) 25/04/2034

(540) Trademark Renewal



(511) 11 and 21

(210) No. 3017

(220) 16/05/1994

(732) ZOJIRUSHI CORPORATION.

20-5, Tenma 1-chome, Kita-ku, Osaka,  
JAPAN, Japan

(111) No. 2941

(180) 16/05/2034

(540) Trademark Renewal

**NISSIN**

(511) 30

(210) No. 3034

(220) 02/06/1994

(732) NISSIN FOODS HOLDINGS CO., LTD

1-1, 4-chome, Nishinakajima, Yodogawa-ku,  
Osaka, Japan

(111) No. 2950

(180) 02/06/2034

(540) Trademark Renewal

**DEMAE RAMEN**

(511) 30

(210) No. 3036

(220) 02/06/1994

(732) NISSIN FOODS HOLDINGS CO., LTD

1-1, 4-chome, Nishinakajima, Yodogawa-ku,  
Osaka, Japan

(111) No. 2952

(180) 02/06/2034

(540) Trademark Renewal



(511) 30

(210) No. 3042

(220) 02/06/1994

(732) NISSIN FOODS HOLDINGS CO., LTD

1-1, 4-chome, Nishinakajima, Yodogawa-ku,  
Osaka, Japan

(111) No. 2958

(180) 02/06/2034

(540) Trademark Renewal

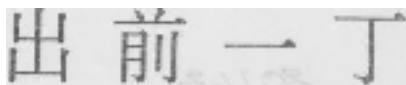

(511) 30

(210) No. 3043

(220) 02/06/1994

(732) NISSIN FOODS HOLDINGS CO., LTD

1-1, 4-chome, Nishinakajima, Yodogawa-ku,  
Osaka, Japan

(111) No. 2959

(180) 02/06/2034

(540) Trademark Renewal

**TOP RAMEN**

(511) 30

(210) No. 3044

(220) 02/06/1994

(732) NISSIN FOOD HOLDINGS CO., LTD

1-1, 4-chome, Nishinakajima, Yodogawa-ku,  
Osaka, Japan

(111) No. 2960

(180) 02/06/2034

(540) Trademark Renewal

**KIA**

(511) 12

(210) No. 3109

(220) 24/06/1994

(732) Kia Corporation

12, Heolleung-ro, Seocho-gu Seoul 06797  
Republic of Korea, Republic of Korea

(111) No. 2982

(180) 24/06/2034

(540) Trademark Renewal

**ANDRE**

(511) 33

(210) No. 2864

(220) 21/03/1994

(732) Batmark Limited

Glove House, 4 Temple Place, London WC2R

2 PG, United Kingdom

(111) No. 2997

(180) 21/03/2034

(540) Trademark Renewal

**E & J**

(511) 33

(210) No. 2880

(220) 21/03/1994

(732) E.&J. Gallo Winery

600 Yosemite Boulevard, Modesto, California

95354, United States of America

(111) No. 3000

(180) 21/03/2034

(540) Trademark Renewal

**ERNEST & JULIO  
GALLO**

(511) 33

(210) No. 2931

(220) 12/04/1994

(732) E. & J. GALLO WINERY

600 Yosemite Boulevard, Modesto, California  
95354, United States of America

(111) No. 3001

(180) 12/04/2034

(540) Trademark Renewal

**GALLO**

(511) 33

(210) No. 2932

(220) 12/04/1994

(732) E. & J. GALLO WINERY

600 Yosemite Boulevard, Modesto, California  
95354, United States of America

(111) No. 3002

(180) 12/04/2034

(540) Trademark Renewal

**LONGBEACH**

(511) 34

(210) No. 2987

(220) 03/05/1994

(732) Philip Morris Brands Sàrl

Quai Jeanrenaud 3, 2000 Neuchâtel,  
Switzerland

(111) No. 3018

(180) 03/05/2034

(540) Trademark Renewal

**ISUZU**

(511) 12

(210) No. 2996

(220) 10/05/1994

(732) ISUZU JIDOSHA KABUSHIKI KAISHA

(also trading as ISUZU MOTORS LIMITED)

2-5, Takashima 1-chome, Nishi-ku,

Yokohama-shi, Kanagawa, 220-8720, Japan

(111) No. 3019

(180) 10/05/2034

(540) Trademark Renewal

**LEGACY**

(511) 12

(210) No. 3001

(220) 10/05/1994

(732) SUBARU CORPORATION

1-20-8, Ebisu, Shibuya-ku, Tokyo, Japan

(111) No. 3024

(180) 10/05/2034

(540) Trademark Renewal



(511) 12

(210) No. 3002

(220) 10/05/1994

(732) SUBARU CORPORATION

1-20-8, Ebisu, Shibuya-ku, Tokyo, Japan

(111) No. 3025

(180) 10/05/2034



(540) Trademark Renewal

**SUBARU**

(511) 12

(210) No. 3003

(220) 10/05/1994

(732) SUBARU CORPORATION

1-20-8, Ebisu, Shibuya-ku, Tokyo, Japan

(111) No. 3026

(180) 10/05/2034

(540) Trademark Renewal

**KINCHO**

(511) 03 and 05

(210) No. 3139

(220) 08/07/1994

(732) DAINIHON JOCHUGIKU COMPANY,

LIMITED

4-11, 1-chome, Tosabori, Nishi-ku, Osaka,

Japan

(111) No. 3063

(180) 08/07/2034

(540) Trademark Renewal



(511) 03 and 05

(210) No. 3140

(220) 08/07/1994

(732) DAINIHON JOCHUGIKU COMPANY,  
LIMITED

4-11, 1-chome, Tosabori, Nishi-ku, Osaka,  
Japan

(111) No. 3064

(180) 08/07/2034

(540) Trademark Renewal

**AESFULAP**

(511) 10

(210) No. 2579

(220) 15/10/1993

(732) Aesculap AG

Am Aesculap-Platz, 78532 Tuttlingen,  
Germany

(111) No. 3132

(180) 15/10/2033

(540) Trademark Renewal



(511) 10

(210) No. 2580

(220) 15/10/1993

(732) Aesculap AG

Am Aesculap-Platz, 78532 Tuttlingen,  
Germany

(111) No. 3133

(180) 15/10/2033

(540) Trademark Renewal



(511) 05

(210) No. 3206

(220) 15/08/1994

(732) Tai Tong Ah Co Pte Ltd

6 Kaki Bukit View, Kaki Bukit TechPark II,  
Singapore 415944, Singapore

(111) No. 3185

(180) 15/08/2034

(540) Trademark Renewal



(511) 30

(210) No. 3247

(220) 12/09/1994

(732) THE GARDEN COMPANY LIMITED

58 Castle Peak Road, Kowloon, Japan

(111) No. 3196

(180) 12/09/2034

(540) Trademark Renewal

**AMWAY**

(511) 03

(210) No. 3080

(220) 15/06/1994

(732) ALTICOR INC

7575 Fulton Street East, Ada, Michigan 49355,

United States of America

(111) No. 3271

(180) 15/06/2034

(540) Trademark Renewal

**CHARLES  
HEIDSIECK**

(511) 33

(210) No. 3087

(220) 15/06/1994

(732) CHARLES HEIDSIECK SAS

12 Allée du Vignoble, 51100 Reims, France

(111) No. 3278

(180) 15/06/2034

(540) Trademark Renewal



(511) 12

(210) No. 3092

(220) 15/06/1994

(732) Hino Jidosha Kabushiki Kaisha (also trading  
as Hino Motors Ltd.)

1-1, Hinodai 3-Chome, Hino-Shi, Tokyo,  
Japan

(111) No. 3283

(180) 15/06/2034

(540) Trademark Renewal



(511) 25

(210) No. 3156

(220) 27/07/1994

(732) DONALD BYFORD & SONS SDN.BHD., (DBSM)

53A, Jalan SS21/1A, Damansara Utama,  
47400 Petaling Jaya, Selangor Darul Ehsan,  
United Kingdom

(111) No. 3289

(180) 27/07/2034

(540) Trademark Renewal

**ASHWORTH**

(511) 25

(210) No. 3357

(220) 18/10/1994

(732) YGM Retail Limited

1/F, 22 Tai Yau Street, San Po Kong,  
Kowloon, Hong Kong

(111) No. 3354

(180) 18/10/2034

(540) Trademark Renewal



(511) 25

(210) No. 3363

(220) 18/10/1994

(732) YGM Retail Limited

1/F, 22 Tai Yau Street, San Po Kong,  
Kowloon, Hong Kong

(111) No. 3360

(180) 18/10/2034

(540) Trademark Renewal



(511) 18 and 25

(210) No. 2923

(220) 29/03/1994

(732) HAVIP (LAOS) INTELLECTUAL  
PROPERTY LAW SOLE CO., LTD. and  
DESCENTE LTD.

Ban Dongmieng, Unit 26, Chanthabouly  
District, , Vientiane Cap, Lao People's  
Democratic Republic and Maruito Namba  
Building 13F, 2-3, Minatomachi 1-chome,  
Naniwa-ku, Osaka, Japan

(111) No. 3367

(180) 29/03/2034

(540) Trademark Renewal



(511) 07, 08, 09 and 16

(210) No. 2357

(220) 03/08/1993

(732) Stanley Black & Decker, Inc.

1000, Stanley Drive, New Britain,

Connecticut 06053, United States of America

(111) No. 3488

(180) 03/08/2043

(540) Trademark Renewal

**501**

(511) 34

(210) No. 3300

(220) 14/09/1994

(732) LEVI STRAUSS & CO

1155 Battery Street, San Francisco, California

94111, United States of America

(111) No. 3605

(180) 14/09/2034



(540) Trademark Renewal



(511) 30

(210) No. 9914

(220) 24/01/2003

(732) BERLI JUCKER FOODS LIMITED  
225/10 Theparak Rd., Bangsaothong,  
Samutprakarn 10540, Thailand

(111) No. 9441

(180) 24/01/2033

(540) Trademark Renewal



(511) 41

(210) No. 10290

(220) 03/06/2003

(732) Daltrey Funding LP.  
48 Wall Street, 27th floor, New York, NF  
10005, United States Of America

(111) No. 9812

(180) 10/06/2033

(540) Trademark Renewal



(511) 41

(210) No. 10291

(220) 03/06/2003

(732) Daltrey Funding LP.

48 Wall Street, 27th floor, New York, NY  
10005, United States Of America

(111) No. 9813

(180) 10/06/2033

(540) Trademark Renewal

**ISON**

(511) 06

(210) No. 10511

(220) 09/09/2003

(732) ISON ENTERERISE CONIANY LIMITED

657/99-100, Lad Phrao 80 Alley (Chanthima  
Alley 11 Sub-alley), Wang Thonglang Sub-  
District, Wang Thonglang District, Bangkok  
Metropolis 10310 , Thailand

(111) No. 10031

(180) 05/09/2044

(540) Trademark Renewal

**EXPRESSIONS**

(511) 16

(210) No. 10757

(220) 14/11/2003

(732) KIMBERLY-CLARK WORLDWIDE, INC

Neenah, Wisconsin 54956,

United States of America

(111) No. 10264

(180) 04/09/2044

(540) Trademark Renewal

**TISS**

(511) 16

(210) No. 10758

(220) 14/11/2003

(732) KIMBERLY-CLARK WORLDWIDE, INC

Neenah, Wisconsin 54956,

United States of America

(111) No. 10265

(180) 04/09/2044

(540) Trademark Renewal

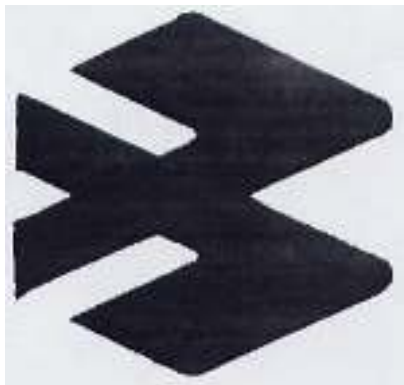

(511) 12

(210) No. 10879

(220) 23/12/2003

(732) BAJAJ AUTO LIMITED

Akurdi, Pune 411 035, Maharashtra, India

(111) No. 10383

(180) 22/12/2033

(540) Trademark Renewal

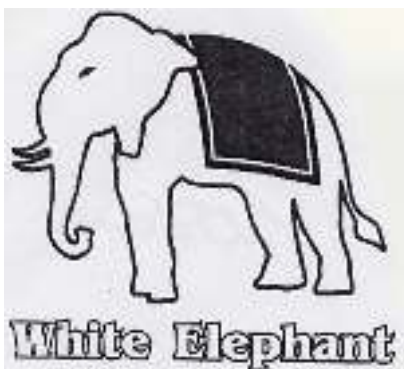

(511) 18

(210) No. 10885

(220) 30/12/2003

(732) I.C.C International Public Company Limited

530 Soi Sathupradit 58, Bangpongpan,

Yannawa, Bangkok 10120, Thailand

(111) No. 10388

(180) 30/12/2033

(540) Trademark Renewal

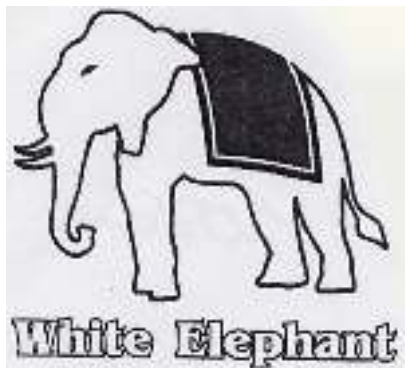

(511) 25

(210) No. 10886

(220) 30/12/2003

(732) I.C.C International Public Company Limited  
530 Soi Sathupradit 58, Bangpongpan,  
Yannawa, Bangkok 10120, Thailand

(111) No. 10389

(180) 30/12/2033

(540) Trademark Renewal



(511) 03

(210) No. 10900

(220) 07/01/2004

(732) RUBIA INDUSTRIES LTD  
70 Mu 13, Poochaosamingprai Road,  
Bangyapraek, Phrapradaeng, Samutprakarn  
10130, Thailand

(111) No. 10403

(180) 25/09/2044

(540) Trademark Renewal

**CARIBAN**

(511) 05

(210) No. 10910

(220) 12/01/2004

(732) ITALFARMACO SpA

Viale Fulvio Testi 330-I-20126 Milan, Italia,  
Spain

(111) No. 10413

(180) 02/09/2044

(540) Trademark Renewal

**HONGTASHAN**

(511) 34

(210) No. 10913

(220) 12/01/2004

(732) HONGTA TOBACCO ( GROUP ) CO., LTD

118, HONGTA AVENUE, HONGTA  
DISTRICT, YUXI, YUNNA, CHINA

(111) No. 10416

(180) 04/09/2044

(540) Trademark Renewal



(511) 33

(210) No. 10918

(220) 12/01/2004

(732) SICHUAN YIBIN WULIANGYE GROUP  
CO., LTD

# 150, Minjiang West Road, Yibin Sichuan,  
People's Republic of China

(111) No. 10421

(180) 03/09/2044

(540) Trademark Renewal



(511) 32

(210) No. 10926

(220) 19/01/2004

(732) Carabao Tawandang Co., Ltd

393 Silom Building, 7th -10th Floor, 393  
Silom, Bangrak, Bangkok 10500, Thailand

(111) No. 10429

(180) 03/10/2044

(540) Trademark Renewal

**PARLIAMENT**

(511) 33

(210) No. 10929

(220) 19/01/2004

(732) Copecrestos Enterprises Limited

55 Grigori Afxentiou, Agia Varvara, 2560

Nicosia, Cyprus, Cyprus

(111) No. 10430

(180) 19/01/2034

(540) Trademark Renewal



(511) 03

(210) No. 10944

(220) 21/01/2004

(732) Rungcharoon & Sons Co., Ltd.

10 Soi Suksawat 30 Junction 8-1 Suksawat

Road Bangkok Radboorana Bangkok

10140, Thailand

(111) No. 10445

(180) 02/09/2044



(540) Trademark Renewal

**TIMBERLAND**

(511) 25

(210) No. 10951

(220) 27/01/2004

(732) TBL LICENSING LLC

200 Domain Drive, Stratham, New

Hampshire 03885, United States of America

(111) No. 10452

(180) 05/09/2044

(540) Trademark Renewal



(511) 25

(210) No. 10952

(220) 27/01/2004

(732) TBL LICENSING LLC

200 Domain Drive, Stratham, New

Hampshire 03885, United States of America

(111) No. 10453

(180) 05/09/2044

(540) Trademark Renewal

**GARDASIL**

(511) 05

(210) No. 10875

(220) 19/12/2003

(732) MERCK SHARP & DOHME LLC

126 East Lincoln Ave., P.O. Box 2000,

Rahway, NJ 07065, United States Of America

(111) No. 10479

(180) 19/12/2033

(540) Trademark Renewal



(511) 30

(210) No. 10978

(220) 02/02/2004

(732) THAI PRESIDENT FOODS PUBLIC

COMPANY LIMITED

304 Srinakarin Road, Huamark, Bangkok,

Bangkok 10240, Thailand

(111) No. 10482

(180) 02/02/2034

(540) Trademark Renewal



(511) 30

(210) No. 10979

(220) 02/02/2004

(732) Thai President Foods Public Company  
Limited

304 Srinakarin Road, Huamark Sub-district,  
Bangkapi District, Bangkok 10240 , Thailand

(111) No. 10483

(180) 02/09/2044

(540) Trademark Renewal



(511) 05

(210) No. 10982

(220) 03/02/2004

(732) TJIOE BUDI YUWONO (INDONESIAN  
CITIZENS).

, Pluit Timur Blok 1 Selatan/42,  
Rt.003/Rw.009 Kel. Pluit, Kec. Penjaringan,  
Jakarta-Utara, Indonesia

(111) No. 10484

(180) 05/09/2044

(540) Trademark Renewal



(511) 05

(210) No. 10983

(220) 03/02/2004

(732) TJIOE BUDI YUWONO (INDONESIAN  
CITIZEN).

Pluit Timur Blok 1 Selatan/42,

Rt.003/Rw.009 Kel. Pluit, Kec. Penjaringan,

Jakarta-Utara, Indonesia

(111) No. 10485

(180) 05/09/2044

(540) Trademark Renewal



(511) 32

(210) No. 10984

(220) 03/02/2004

(732) TJIOE BUDI YUWONO (INDONESIAN  
CITIZEN).

Pluit Timur Blok 1 Selatan/42,

Rt.003/Rw.009 Kel. Pluit, Kec. Penjaringan,

Jakarta-Utara, Pluit Timur Blok 1 Selatan/42,

Rt.003/Rw.009 Kel. Pluit, Kec. Penjaringan,

Jakarta-Utara, , Indonesia

(111) No. 10486

(180) 05/09/2044

(540) Trademark Renewal



(511) 05

(210) No. 10985

(220) 03/02/2004

(732) TJIOE BUDI YUWONO (INDONESIAN  
CITIZEN).

Pluit Timur Blok 1 Selatan/42,

Rt.003/Rw.009 Kel. Pluit, Kec. Penjaringan,

Jakarta-Utara, Indonesia

(111) No. 10487

(180) 05/09/2044

(540) Trademark Renewal



(511) 32

(210) No. 10986

(220) 03/02/2004

(732) TJIOE BUDI YUWONO (INDONESIAN  
CITIZEN).

Pluit Timur Blok 1 Selatan/42,

Rt.003/Rw.009 Kel. Pluit, Kec. Penjaringan,

Jakarta-Utara, Indonesia

(111) No. 10488

(180) 05/09/2044

(540) Trademark Renewal



(511) 05

(210) No. 10987

(220) 03/02/2004

(732) TJIOE BUDI YUWONO (INDONESIAN  
CITIZEN).

Pluit Timur Blok 1 Selatan/42,

Rt.003/Rw.009 Kel. Pluit, Kec. Penjaringan,

Jakarta-Utara, Indonesia

(111) No. 10489

(180) 05/09/2044

(540) Trademark Renewal



(511) 32

(210) No. 10988

(220) 03/02/2004

(732) TJIOE BUDI YUWONO (INDONESIAN  
CITIZENS).

Pluit Timur Blok 1 Selatan/42,

Rt.003/Rw.009 Kel. Pluit, Kec. Penjaringan,

Jakarta-Utara, Indonesia

(111) No. 10490

(180) 05/09/2044

(540) Trademark Renewal



(511) 03

(210) No. 11002

(220) 10/02/2004

(732) LACOSTE

31-37, boulevard de Montmorency 75016

Paris, France

(111) No. 10503

(180) 10/02/2034

(540) Trademark Renewal



(511) 03

(210) No. 11003

(220) 10/02/2004

(732) LACOSTE

31-37, boulevard de Montmorency 75016

Paris, France

(111) No. 10504

(180) 10/02/2034

(540) Trademark Renewal

**VALDOXAN**

(511) 05

(210) No. 11007

(220) 11/02/2004

(732) BIOFARMA

50, rue Carnot, 92284 Suresnes Cedex, France

(111) No. 10508

(180) 04/09/2044

(540) Trademark Renewal



(511) 32

(210) No. 11034

(220) 18/02/2004

(732) Stokely-Van Camp, Inc.

700 Anderson Hill Road, Purchase, New

York 10577, United States of America

(111) No. 10532

(180) 04/09/2044



(540) Trademark Renewal

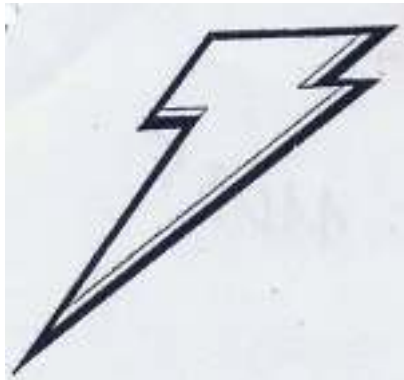

(511) 32

(210) No. 11035

(220) 18/02/2004

(732) Stokely-Van Camp, Inc.

700 Anderson Hill Road, Purchase, New  
York 10577, United States of America

(111) No. 10533

(180) 04/09/2044

(540) Trademark Renewal



(511) 32

(210) No. 11036

(220) 18/02/2004

(732) Stokely-Van Camp, Inc.

700 Anderson Hill Road, Purchase, New  
York 10577, United States of America

(111) No. 10534

(180) 04/09/2044

(540) Trademark Renewal

**AVERNA**

(511) 33

(210) No. 11037

(220) 20/02/2004

(732) Davide Campari-Milano N.V.

Herengracht 420 (1017BZ), Amsterdam,  
The Netherlands

(111) No. 10535

(180) 07/10/2044

(540) Trademark Renewal

**FRATTINA**

(511) 02

(210) No. 11043

(220) 20/02/2004

(732) Davide Campari-Milano N.V.

Herengracht 420 (1017BZ), Amsterdam,  
The Netherlands

(111) No. 10541

(180) 02/10/2044

(540) Trademark Renewal

**BFG**

(511) 12

(210) No. 11046

(220) 24/02/2004

(732) COMPAGNIE GENERALE DES

ETABLISSEMENTS MICHELIN

23, Place des Carmes-Déchaux, 63000

Clermont-Ferrand, France

(111) No. 10544

(180) 03/09/2044

(540) Trademark Renewal

**BFG**

(511) 17

(210) No. 11047

(220) 24/02/2004

(732) COMPAGNIE GENERALE DES

ETABLISSEMENTS MICHELIN

23, Place des Carmes-Déchaux, 63000

Clermont-Ferrand, France

(111) No. 10545

(180) 03/09/2044

(540) Trademark Renewal

**BFGOODRICH**

(511) 12

(210) No. 11048

(220) 24/02/2004

(732) COMPAGNIE GENERALE DES

ETABLISSEMENTS MICHELIN

23, Place des Carmes-Déchaux, 63000

Clermont-Ferrand, France

(111) No. 10546

(180) 03/09/2044

(540) Trademark Renewal

**BFGOODRICH**

(511) 17

(210) No. 11049

(220) 24/02/2004

(732) COMPAGNIE GENERALE DES

ETABLISSEMENTS MICHELIN

23, Place des Carmes-Déchaux, 63000

Clermont-Ferrand, France

(111) No. 10547

(180) 03/09/2044

(540) Trademark Renewal



(511) 21

(210) No. 11050

(220) 24/02/2004

(732) J.T. Ronnefeldt KG

Jan-Weber-StraBe 2, 27726 Worpswede,  
Germany

(111) No. 10548

(180) 24/02/2034

(540) Trademark Renewal



(511) 30

(210) No. 11051

(220) 24/02/2004

(732) J.T. Ronnefeldt KG

Jan-Weber-StraBe 2, 27726 Worpswede,  
Germany

(111) No. 10549

(180) 24/02/2034

(540) Trademark Renewal

**SINGHA**

(511) 32

(210) No. 11055

(220) 24/02/2004

(732) Boon Rawd Brewery Co.Ltd

999 Samsen Road, bangkok 10300, Thailand

(111) No. 10553

(180) 04/09/2044

(540) Trademark Renewal



(511) 32

(210) No. 11056

(220) 24/02/2004

(732) Boon Rawd Brewery Co.Ltd

999 Samsen Road, bangkok 10300, Thailand

(111) No. 10554

(180) 04/09/2044

(540) Trademark Renewal

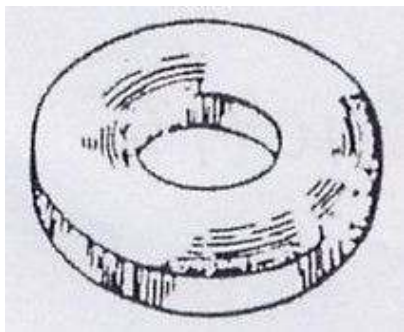

(511) 30

(210) No. 10993

(220) 04/02/2004

(732) Wm. Wrigley Jr. Company

1132 West Blackhawk Street, 60642

Chicago, Illinois, United States of America

(111) No. 10563

(180) 01/10/2044

(540) Trademark Renewal

**FLEMEX**

(511) 05

(210) No. 10882

(220) 25/12/2003

(732) DKSH INTERNATIONAL AG

Wiesenstrasse 8, 8008 Zürich, Swaziland

(111) No. 10564

(180) 04/09/2044

(540) Trademark Renewal



(511) 25

(210) No. 11068

(220) 05/03/2004

(732) XTEP (CHINA) CO., LTD

Qingmeng Park, Economic & Technological  
Development Zone, Quanzhou, Fujian  
Province, China

(111) No. 10569

(180) 05/03/2034

(540) Trademark Renewal

**HONDA**

(511) 07

(210) No. 11084

(220) 18/03/2004

(732) HONDA GIKEN KOGYO KABUSHIKI

KAISHA (ALSO TRADING AS HONDA  
MOTOR CO., LTD).

1-1, Minami-Aoyama 2-Chome, Minato-ku,  
Tokyo 107-8556, Japan

(111) No. 10583

(180) 18/03/2034



(540) Trademark Renewal

**HONDA**

(511) 12

(210) No. 11085

(220) 18/03/2004

(732) HONDA GIKEN KOGYO KABUSHIKI  
KAISHA (ALSO TRADING AS HONDA  
MOTOR CO., LTD).

1-1, Minami-Aoyama 2-Chome, Minato-ku,  
Tokyo 107-8556, Japan

(111) No. 10584

(180) 18/03/2034

(540) Trademark Renewal

**HONDA**

(511) 16

(210) No. 11086

(220) 18/03/2004

(732) HONDA GIKEN KOGYO KABUSHIKI  
KAISHA (ALSO TRADING AS HONDA  
MOTOR CO., LTD).

1-1, Minami-Aoyama 2-Chome, Minato-ku,  
Tokyo 107-8556, Japan

(111) No. 10585

(180) 18/03/2034

(540) Trademark Renewal

**HONDA**

(511) 27

(210) No. 11087

(220) 18/03/2004

(732) HONDA GIKEN KOGYO KABUSHIKI  
KAISHA (ALSO TRADING AS HONDA  
MOTOR CO., LTD).

1-1, Minami-Aoyama 2-Chome,. Minato-ku,  
Tokyo 107-8556, Japan

(111) No. 10586

(180) 18/03/2034

(540) Trademark Renewal

**HONDA**

(511) 37

(210) No. 11088

(220) 18/03/2004

(732) HONDA GIKEN KOGYO KABUSHIKI  
KAISHA (ALSO TRADING AS HONDA  
MOTOR CO., LTD).

1-1, Minami-Aoyama 2-Chome,. Minato-ku,  
Tokyo 107-8556, Japan

(111) No. 10587

(180) 18/03/2034

(540) Trademark Renewal



(511) 07

(210) No. 11089

(220) 18/03/2004

(732) HONDA GIKEN KOGYO KABUSHIKI  
KAISHA (ALSO TRADING AS HONDA  
MOTOR CO., LTD).

1-1, Minami-Aoyama 2-Chome, Minato-ku,  
Tokyo 107-8556, Japan

(111) No. 10588

(180) 18/03/2034

(540) Trademark Renewal



(511) 12

(210) No. 11090

(220) 18/03/2004

(732) HONDA GIKEN KOGYO KABUSHIKI  
KAISHA (ALSO TRADING AS HONDA  
MOTOR CO., LTD).

1-1, Minami-Aoyama 2-Chome, Minato-ku,  
Tokyo 107-8556, Japan

(111) No. 10589

(180) 18/03/2034

(540) Trademark Renewal



(511) 16

(210) No. 11091

(220) 18/03/2004

(732) HONDA GIKEN KOGYO KABUSHIKI  
KAISHA (ALSO TRADING AS HONDA  
MOTOR CO., LTD).

1-1, Minami-Aoyama 2-Chome, Minato-ku,  
Tokyo 107-8556, Japan

(111) No. 10590

(180) 18/03/2034

(540) Trademark Renewal



(511) 27

(210) No. 11092

(220) 18/03/2004

(732) HONDA GIKEN KOGYO KABUSHIKI  
KAISHA (ALSO TRADING AS HONDA  
MOTOR CO., LTD).

1-1, Minami-Aoyama 2-Chome, Minato-ku,  
Tokyo 107-8556, Japan

(111) No. 10591

(180) 18/03/2034

(540) Trademark Renewal



(511) 37

(210) No. 11093

(220) 18/03/2004

(732) HONDA GIKEN KOGYO KABUSHIKI  
KAISHA (ALSO TRADING AS HONDA  
MOTOR CO., LTD).

1-1, Minami-Aoyama 2-Chome,, Minato-ku,  
Tokyo 107-8556, Japan

(111) No. 10592

(180) 18/03/2034

(540) Trademark Renewal



(511) 12

(210) No. 11100

(220) 18/03/2004

(732) SANKEI INDUSTRY CO., LTD

305. Takano, Ritto shi, Shiga, Japan

(111) No. 10599

(180) 08/10/2044

(540) Trademark Renewal

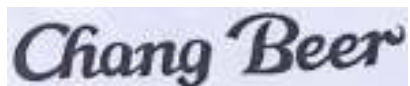
The logo for Chang Beer, featuring the words "Chang Beer" in a stylized, cursive font. The text is white and set against a light blue rectangular background.

(511) 32

(210) No. 11101

(220) 18/03/2004

(732) Beer Chang Co., Ltd.

15 Moo 14, Vibhavadi Rangsit Road,

Chomphon Sub-District, Chatuchak District,

Bangkok 10900, Thailand

(111) No. 10600

(180) 30/09/2044

(540) Trademark Renewal



(511) 32

(210) No. 11102

(220) 18/03/2004

(732) Beer Chang Co., Ltd.

15 Moo 14, Vibhavadi Rangsit Road,

Chomphon Sub-District, Chatuchak District,

Bangkok 10900, Thailand

(111) No. 10601

(180) 30/09/2044

(540) Trademark Renewal



(511) 30

(210) No. 11104

(220) 18/03/2004

(732) KABUSHIKI KAISHA MIZKAN  
HOLDINGS.

2-6 Nakamura-cho, Handa-shi, Aichi-ken,  
Japan

(111) No. 10603

(180) 26/09/2044

(540) Trademark Renewal



(511) 30

(210) No. 11105

(220) 18/03/2004

(732) KABUSHIKI KAISHA MIZKAN  
HOLDINGS.

2-6 Nakamura-cho, Handa-shi, Aichi-ken,  
Japan

(111) No. 10604

(180) 26/09/2044

(540) Trademark Renewal



(511) 25

(210) No. 11106

(220) 18/03/2004

(732) LONG THANH ESTABLISHMENT

67B Thap Muoi Street, Ward 2, District 6,

Ho Chi Minh City, Vietnam

(111) No. 10605

(180) 04/09/2044

(540) Trademark Renewal



(511) 05

(210) No. 11113

(220) 19/03/2004

(732) Greater Pharma Co., Ltd.

No. 55/2, Village No. 1, Salaya-Nakhon Chai

Sri Road, Salaya Sub-District

Phutthamonthon District, Nakhon Pathom

Province, Thailand

(111) No. 10612

(180) 18/03/2034



(540) Trademark Renewal



(511) 05

(210) No. 11114

(220) 19/03/2004

(732) Greater Pharma Co., Ltd.

No. 55/2, Village No. 1, Salaya-Nakhon Chai

Sri Road, Salaya Sub-District

Phutthamonthon District, Nakhon Pathom

Province, Thailand

(111) No. 10613

(180) 18/03/2034

(540) Trademark Renewal

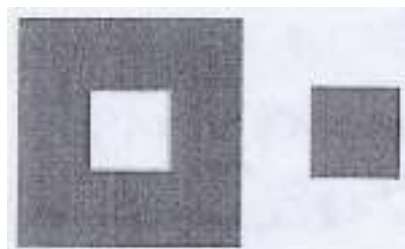

(511) 01

(210) No. 11118

(220) 19/03/2004

(732) BASF SE

Carl-Bosch-Strasse 38, Ludwigshafen am

Rhein, Germany

(111) No. 10617

(180) 19/03/2034

(540) Trademark Renewal

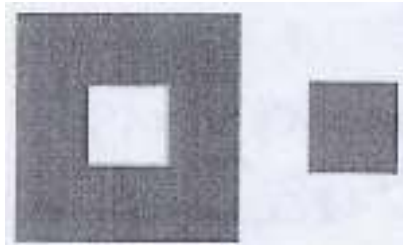

(511) 02

(210) No. 11119

(220) 19/03/2004

(732) BASF SE

Carl-Bosch-Strasse 38, Ludwigshafen am  
Rhein, Germany

(111) No. 10618

(180) 19/03/2034

(540) Trademark Renewal

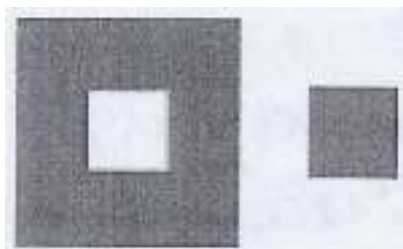

(511) 03

(210) No. 11120

(220) 19/03/2004

(732) BASF SE

Carl-Bosch-Strasse 38, Ludwigshafen am  
Rhein, Germany

(111) No. 10619

(180) 19/03/2034

(540) Trademark Renewal

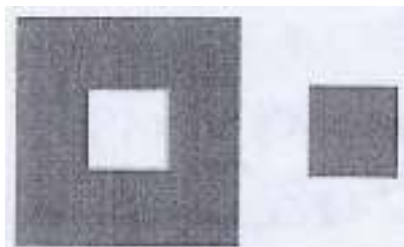

(511) 04

(210) No. 11121

(220) 19/03/2004

(732) BASF SE

Carl-Bosch-Strasse 38, Ludwigshafen am  
Rhein, Germany

(111) No. 10620

(180) 19/03/2034

(540) Trademark Renewal

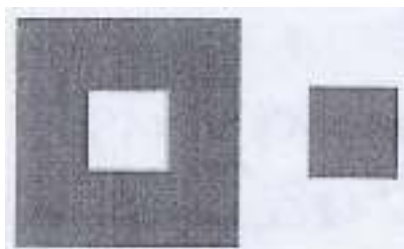

(511) 05

(210) No. 11122

(220) 19/03/2004

(732) BASF SE

Carl-Bosch-Strasse 38, Ludwigshafen am  
Rhein, Germany

(111) No. 10621

(180) 19/03/2034

(540) Trademark Renewal

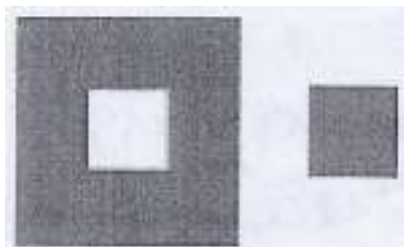

(511) 16

(210) No. 11124

(220) 19/03/2004

(732) BASF SE

Carl-Bosch-Strasse 38, Ludwigshafen am  
Rhein, Germany

(111) No. 10623

(180) 19/03/2034

(540) Trademark Renewal

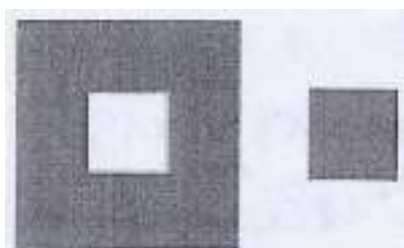

(511) 17

(210) No. 11125

(220) 19/03/2004

(732) BASF SE

Carl-Bosch-Strasse 38, Ludwigshafen am  
Rhein, Germany

(111) No. 10624

(180) 19/03/2034

(540) Trademark Renewal

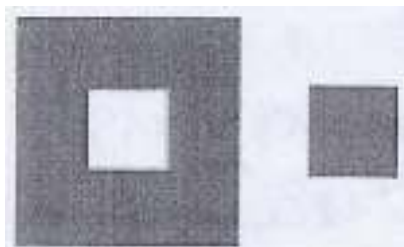

(511) 31

(210) No. 11128

(220) 19/03/2004

(732) BASF SE

Carl-Bosch-Strasse 38, Ludwigshafen am  
Rhein, Germany

(111) No. 10627

(180) 19/03/2034

(540) Trademark Renewal

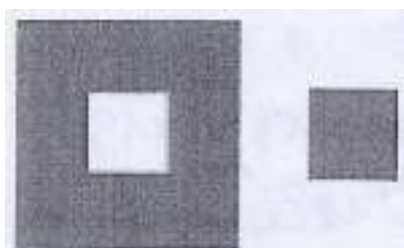

(511) 42

(210) No. 11129

(220) 19/03/2004

(732) BASF SE

Carl-Bosch-Strasse 38, Ludwigshafen am  
Rhein, Germany

(111) No. 10628

(180) 19/03/2034

(540) Trademark Renewal



(511) 03

(210) No. 11130

(220) 19/03/2004

(732) Unilever Global IP Limited

Port Sunlight, Wirral, Merseyside, CH62  
4ZD, United Kingdom

(111) No. 10629

(180) 19/03/2034

(540) Trademark Renewal



(511) 21

(210) No. 11131

(220) 19/03/2004

(732) Unilever Global IP Limited

Port Sunlight, Wirral, Merseyside, CH62  
4ZD, United Kingdom

(111) No. 10630

(180) 19/03/2034

(540) Trademark Renewal

**Air Asia**

(511) 39

(210) No. 11184

(220) 29/03/2004

(732) AIRASIA BERHAD

Lot N1, Level 4, Main Terminal Building, KL  
International Airport, 64000 KLIA, Sepang,  
Selangor Darul Ehsan, Malaysia

(111) No. 10674

(180) 28/03/2034

(540) Trademark Renewal

**M-SPORT**

(511) 32

(210) No. 11189

(220) 30/03/2004

(732) Osotspa Public Company Limited

348 Ramkhamhaeng Road, Huamak, Bangkok,  
Bangkok 10240, Thailand

(111) No. 10679

(180) 30/03/2034

(540) Trademark Renewal

**GLAKAY**

(511) 05

(210) No. 11197

(220) 06/04/2004

(732) EISAI R&D MANAGEMENT CO., LTD.

6-10, Koishikawa 4-chome, Bunkyo-ku, tokyo,  
Japan

(111) No. 10686

(180) 03/10/2044

(540) Trademark Renewal

**SANDISK**

(511) 09

(210) No. 11249

(220) 11/05/2004

(732) SanDisk LLC.

951 SanDisk Drive, Milpitas, California  
95035-7933, United States of America

(111) No. 10738

(180) 10/05/2034



(540) Trademark Renewal

**PREMIER**

(511) 16

(210) No. 11304

(220) 25/05/2004

(732) NIBONG TEBAL PAPER MILL SDN BHD

886, Jalan Bandar Baru, Sungai Kecil, 14300

Nibong Tebal, S.P.S. Pulau Pinang, Malaysia

(111) No. 10791

(180) 04/09/2044

(540) Trademark Renewal



(511) 16

(210) No. 11305

(220) 25/05/2004

(732) NIBONG TEBAL PAPER MILL SDN BHD

886, Jalan Bandar Baru, Sungai Kecil, 14300

Nibong Tebal, S.P.S. Pulau Pinang, Malaysia

(111) No. 10792

(180) 04/09/2044

(540) Trademark Renewal

**CUTIE**

(511) 16

(210) No. 11306

(220) 25/05/2004

(732) NIBONG TEBAL PAPER MILL SDN BHD

886, Jalan Bandar Baru, Sungai Kecil, 14300

Nibong Tebal, S.P.S. Pulau Pinang, Malaysia

(111) No. 10793

(180) 04/09/2044

(540) Trademark Renewal



(511) 16

(210) No. 11307

(220) 25/05/2004

(732) NIBONG TEBAL PAPER MILL SDN BHD

886, Jalan Bandar Baru, Sungai Kecil, 14300

Nibong Tebal, S.P.S. Pulau Pinang, Malaysia

(111) No. 10794

(180) 04/09/2044

(540) Trademark Renewal

**INTIMATE**

(511) 05

(210) No. 11309

(220) 25/05/2004

(732) NIBONG TEBAL PAPER MILL SDN BHD

886, Jalan Bandar Baru, Sungai Kecil, 14300

Nibong Tebal, S.P.S. Pulau Pinang, Malaysia

(111) No. 10796

(180) 04/09/2044

(540) Trademark Renewal



(511) 16

(210) No. 11310

(220) 25/05/2004

(732) NIBONG TEBAL PAPER MILL SDN BHD

886, Jalan Bandar Baru, Sungai Kecil, 14300

Nibong Tebal, S.P.S. Pulau Pinang, Malaysia

(111) No. 10797

(180) 04/09/2044

(540) Trademark Renewal

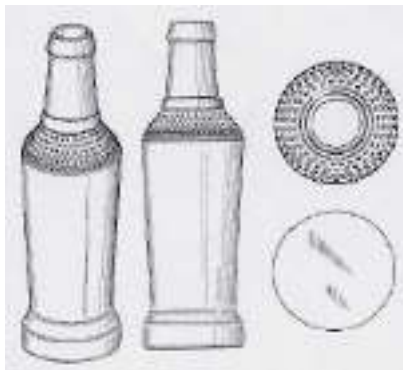

(511) 32

(210) No. 11313

(220) 25/05/2004

(732) PEPSICO, INC

700 Anderson Hill Road, Purchase, NY

10570, United States of America

(111) No. 10800

(180) 02/09/2044

(540) Trademark Renewal



(511) 32

(210) No. 11314

(220) 25/05/2004

(732) PEPSICO, INC

700 Anderson Hill Road, Purchase, New

York 10577, United States of America

(111) No. 10801

(180) 02/09/2044

(540) Trademark Renewal



(511) 36

(210) No. 11315

(220) 26/05/2004

(732) WESTERN UNION HOLDINGS, INC.

7001 East Belleview Avenue, Denver,

Colorado, 80237, United States of America

(111) No. 10802

(180) 26/09/2044

(540) Trademark Renewal



(511) 05

(210) No. 11361

(220) 08/06/2004

(732) Kenvue Inc.

199 Grandview Road, Skillman, NJ 08558,

United States of America

(111) No. 10852

(180) 08/06/2034

(540) Trademark Renewal



(511) 32

(210) No. 11401

(220) 24/06/2004

(732) Green Spot Co. Ltd.

288 Srinagarindra Road, Hua Mark Sub-  
district, Bangkapi District, Bangkok  
Metropolis, Thailand

(111) No. 10892

(180) 24/06/2034

(540) Trademark Renewal

ໄວຕາມິວ

(511) 32

(210) No. 11402

(220) 24/06/2004

(732) Green Spot Co. Ltd.

288 Srinagarindra Road, Hua Mark Sub-  
district, Bangkapi District, Bangkok  
Metropolis, Thailand

(111) No. 10893

(180) 24/06/2034

(540) Trademark Renewal

**SCHWEPPES**

(511) 32

(210) No. 11409

(220) 29/06/2004

(732) EUROPEAN REFRESHMENTS

UNLIMITED COMPANY

Southgate, Dublin Road, Drogheda, County  
Meath, A92 YK7W, Ireland

(111) No. 10899

(180) 29/06/2034

(540) Trademark Renewal

**CANADA DRY**

(511) 32

(210) No. 11411

(220) 29/06/2004

(732) EUROPEAN REFRESHMENTS

UNLIMITED COMPANY

Southgate, Dublin Road, Drogheda, County  
Meath, A92 YK7W, Ireland

(111) No. 10901

(180) 29/06/2034

(540) Trademark Renewal

**DR PEPPER**

(511) 32

(210) No. 11412

(220) 29/06/2004

(732) EUROPEAN REFRESHMENTS UNLIMITED  
COMPANY

Southgate, Dublin Road, Drogheda, County  
Meath, A92 YK7W, Ireland

(111) No. 10902

(180) 29/06/2034

(540) Trademark Renewal



(511) 02

(210) No. 11434

(220) 13/07/2004

(732) 4 ORANGES CO., LTD.

Lot CO2-1, Duc Hoa 1 Industrial Zone, Duc  
Hoa Dong Village, Duc Hoa District, Long  
An Province,, Vietnam

(111) No. 10924

(180) 13/07/2034



(540) Trademark Renewal



(511) 34

(210) No. 11442

(220) 15/07/2004

(732) Carabao Tawandang Co., Ltd

393 Silom Building, 7th -10th Floor, 393

Silom Road, Silom, Bangrak, Bangkok

10500, Thailand

(111) No. 10932

(180) 15/07/2034

(540) Trademark Renewal

**IPSEN**

(511) 03

(210) No. 11170

(220) 24/03/2004

(732) IPEN S.A

65 Quai Georges Gorse, Boulogne-Billancourt

92100, France

(111) No. 10966

(180) 24/03/2034

(540) Trademark Renewal

**IPSEN**

(511) 05

(210) No. 11171

(220) 24/03/2004

(732) IPEN S.A

65 Quai Georges Gorse, Boulogne-Billancourt  
92100, France

(111) No. 10967

(180) 24/03/2034

(540) Trademark Renewal

**IPSEN**

(511) 42

(210) No. 11172

(220) 24/03/2004

(732) IPEN S.A

65 Quai Georges Gorse, Boulogne-Billancourt  
92100, France

(111) No. 10968

(180) 24/03/2034

(540) Trademark Renewal



(511) 05

(210) No. 11175

(220) 24/03/2004

(732) IPEN S.A

65 Quai Georges Gorse, Boulogne-  
Billancourt 92100, France

(111) No. 10971

(180) 24/03/2034

(540) Trademark Renewal



(511) 42

(210) No. 11176

(220) 24/03/2004

(732) IPSEN S.A

65 Quai Georges Gorse, Boulogne-  
Billancourt 92100, France

(111) No. 10972

(180) 24/03/2034

(540) Trademark Renewal



(511) 05

(210) No. 11179

(220) 24/03/2004

(732) IPSENS.A

65 Quai Georges Gorse, Boulogne-  
Billancourt 92100, France

(111) No. 10975

(180) 24/03/2034

(540) Trademark Renewal



(511) 42

(210) No. 11180

(220) 24/03/2004

(732) IPSEN S.A.

65 Quai Georges Gorse, Boulogne-  
Billancourt 92100, France

(111) No. 10976

(180) 24/03/2034

(540) Trademark Renewal



(511) 29

(210) No. 11490

(220) 03/08/2004

(732) TTT Holding Limited

1011 Supalai Grand Tower, Floor 27, Rama 3  
Road, Chongnonsi, Yannawa, Bangkok  
10120, Thailand

(111) No. 10994

(180) 03/08/2034

(540) Trademark Renewal



(511) 29

(210) No. 11491

(220) 03/08/2004

(732) TTT Holding Limited

1011 Supalai Grand Tower, Floor 27, Rama 3  
Road, Chongnonsi, Yannawa, Bangkok  
10120, Thailand

(111) No. 10995

(180) 03/08/2034

(540) Trademark Renewal



(511) 01

(210) No. 11673

(220) 23/08/2004

(732) PT Sumatra Tobacco Trading Company  
Jalan Pattimura No. 3, Pematang Siantar,  
Sumatera Utara, Indonesia

(111) No. 11111

(180) 01/09/2034

(540) Trademark Renewal



(511) 02

(210) No. 11674

(220) 24/08/2004

(732) PT Sumatra Tobacco Trading Company  
Jalan Pattimura No. 3, Pematang Siantar,  
Sumatera Utara, Indonesia

(111) No. 11112

(180) 01/09/2034

(540) Trademark Renewal



(511) 03

(210) No. 11675

(220) 24/08/2004

(732) PT Sumatra Tobacco Trading Company  
Jalan Pattimura No. 3, Pematang Siantar,  
Sumatera Utara, Indonesia

(111) No. 11113

(180) 01/09/2034

(540) Trademark Renewal



(511) 04

(210) No. 11676

(220) 24/08/2004

(732) PT Sumatra Tobacco Trading Company  
Jalan Pattimura No. 3, Pematang Siantar,  
Sumatera Utara, Indonesia

(111) No. 11114

(180) 01/09/2034

(540) Trademark Renewal



(511) 05

(210) No. 11681

(220) 26/08/2004

(732) PT Sumatra Tobacco Trading Company  
Jalan Pattimura No. 3, Pematang Siantar,  
Sumatera Utara, Indonesia

(111) No. 11115

(180) 01/09/2034

(540) Trademark Renewal



(511) 06

(210) No. 11682

(220) 26/08/2004

(732) PT Sumatra Tobacco Trading Company  
Jalan Pattimura No. 3, Pematang Siantar,  
Sumatera Utara, Indonesia

(111) No. 11116

(180) 01/09/2034



(540) Trademark Renewal



(511) 07

(210) No. 11683

(220) 26/08/2004

(732) PT Sumatra Tobacco Trading Company  
Jalan Pattimura No. 3, Pematang Siantar,  
Sumatera Utara, Indonesia

(111) No. 11117

(180) 01/09/2034

(540) Trademark Renewal



(511) 08

(210) No. 11684

(220) 26/08/2004

(732) PT Sumatra Tobacco Trading Company  
Jalan Pattimura No. 3, Pematang Siantar,  
Sumatera Utara, Indonesia

(111) No. 11118

(180) 01/09/2034

(540) Trademark Renewal



(511) 09

(210) No. 11685

(220) 26/08/2004

(732) PT Sumatra Tobacco Trading Company  
Jalan Pattimura No. 3, Pematang Siantar,  
Sumatera Utara, Indonesia

(111) No. 11119

(180) 01/09/2034

(540) Trademark Renewal



(511) 10

(210) No. 11686

(220) 26/08/2004

(732) PT Sumatra Tobacco Trading Company.  
Jalan Pattimura No. 3, Pematang Siantar,  
Sumatera Utara, Indonesia

(111) No. 11120

(180) 01/09/2034

(540) Trademark Renewal



(511) 11

(210) No. 11687

(220) 26/08/2004

(732) PT Sumatra Tobacco Trading Company  
Jalan Pattimura No. 3, Pematang Siantar,  
Sumatera Utara, Indonesia

(111) No. 11121

(180) 01/09/2034

(540) Trademark Renewal



(511) 12

(210) No. 11688

(220) 26/08/2004

(732) PT Sumatra Tobacco Trading Company  
Jalan Pattimura No. 3, Pematang Siantar,  
Sumatera Utara, Indonesia

(111) No. 11122

(180) 01/09/2034

(540) Trademark Renewal



(511) 13

(210) No. 11689

(220) 26/08/2004

(732) PT Sumatra Tobacco Trading Company  
Jalan Pattimura No. 3, Pematang Siantar,  
Sumatera Utara, Indonesia

(111) No. 11123

(180) 01/09/2034

(540) Trademark Renewal



(511) 14

(210) No. 11690

(220) 26/08/2004

(732) PT Sumatra Tobacco Trading Company  
Jalan Pattimura No. 3, Pematang Siantar,  
Sumatera Utara, Indonesia

(111) No. 11124

(180) 01/09/2034

(540) Trademark Renewal



(511) 15

(210) No. 11691

(220) 26/08/2004

(732) PT Sumatra Tobacco Trading Company  
Jalan Pattimura No. 3, Pematang Siantar,  
Sumatera Utara, Indonesia

(111) No. 11125

(180) 01/09/2034

(540) Trademark Renewal



(511) 16

(210) No. 11692

(220) 26/08/2004

(732) PT Sumatra Tobacco Trading Company  
Jalan Pattimura No. 3, Pematang Siantar,  
Sumatera Utara, Indonesia

(111) No. 11126

(180) 01/09/2034

(540) Trademark Renewal

**BUSHELLS**

(511) 30

(210) No. 11569

(220) 10/08/2004

(732) P.T. SARI INCOFOOD CORPORATION

Desa Tanjung Morawa B, Kabupaten Deli

Serdang, Sumatera Utara,, Indonesia

(111) No. 11230

(180) 10/08/2034

(540) Trademark Renewal

**MacCoffee**

(511) 30

(210) No. 11572

(220) 11/08/2004

(732) FUTURE ENTERPRISES PTE LTD.

31 Harrison Road, #08-01 Food Empire

Business Suites, Singapore 369649

(111) No. 11233

(180) 11/08/2034

(540) Trademark Renewal



(511) 07

(210) No. 11615

(220) 17/08/2004

(732) WU MINGTING

5 Xinrong Road, Xinqiao Zhen, Songjiang  
District, Shanghai 201612, China

(111) No. 11276

(180) 17/08/2034

(540) Trademark Renewal

**GLISTER**

(511) 03

(210) No. 11890

(220) 30/09/2004

(732) ALTICOR INC

7575 Fulton Street East, Ada, Michigan  
49355, United States of America

(111) No. 11432

(180) 30/09/2034

(540) Trademark Renewal

**SA8**

(511) 03

(210) No. 11891

(220) 30/09/2004

(732) ALTICOR INC

7575 Fulton Street East, Ada, Michigan 49355,  
United States of America

(111) No. 11433

(180) 30/09/2034

(540) Trademark Renewal

**SATINIQUE**

(511) 03

(210) No. 11892

(220) 30/09/2004

(732) ALTICOR INC

7575 Fulton Street East, Ada, Michigan  
49355, United States of America

(111) No. 11434

(180) 30/09/2034



(540) Trademark Renewal

**L.O.C**

(511) 03

(210) No. 11893

(220) 30/09/2004

(732) ALTICOR INC

7575 Fulton Street East, Ada, Michigan 49355,  
United States of America

(111) No. 11435

(180) 30/09/2034

(540) Trademark Renewal

**ATMOSPHERE**

(511) 11

(210) No. 11898

(220) 30/09/2004

(732) ALTICOR INC

7575 Fulton Street East, Ada, Michigan  
49355, United States of America

(111) No. 11440

(180) 30/09/2034

(540) Trademark Renewal

**ESPRING**

(511) 11

(210) No. 11899

(220) 30/09/2004

(732) ALTICOR INC

7575 Fulton Street East, Ada, Michigan  
49355, United States of America

(111) No. 11441

(180) 30/09/2034

(540) Trademark Renewal

**ICOOK**

(511) 08

(210) No. 11900

(220) 30/09/2004

(732) ALTICOR INC

7575 Fulton Street East, Ada, Michigan 49355,  
United States of America

(111) No. 11442

(180) 30/09/2034

(540) Trademark Renewal

**ICOOK**

(511) 11

(210) No. 11901

(220) 30/09/2004

(732) ALTICOR INC

7575 Fulton Street East, Ada, Michigan 49355,  
United States of America

(111) No. 11443

(180) 30/09/2034

(540) Trademark Renewal

**ICOOK**

(511) 21

(210) No. 11902

(220) 30/09/2004

(732) ALTICOR INC

7575 Fulton Street East, Ada, Michigan 49355,  
United States of America

(111) No. 11444

(180) 30/09/2034

(540) Trademark Renewal

The Amway logo is displayed in a stylized, bold, sans-serif font. The word "Amway" is written in a dark color, with a thin, curved line underneath the letters, suggesting a shadow or a swoosh. The logo is centered on the left side of the first entry box.

(511) 03

(210) No. 11905

(220) 30/09/2004

(732) ALTICOR INC

7575 Fulton Street East, Ada, Michigan

49355, United States of America

(111) No. 11447

(180) 30/09/2034

(540) Trademark Renewal

The Amway logo is displayed in a stylized, bold, sans-serif font. The word "Amway" is written in a dark color, with a thin, curved line underneath the letters, suggesting a shadow or a swoosh. The logo is centered on the left side of the second entry box.

(511) 05

(210) No. 11906

(220) 30/09/2004

(732) ALTICOR INC

7575 Fulton Street East, Ada, Michigan

49355, United States of America

(111) No. 11448

(180) 30/09/2034

(540) Trademark Renewal

The Amway logo consists of the word "Amway" in a bold, sans-serif font. The letters are black with a white outline, giving it a 3D or embossed appearance. A thin, curved line underlines the word.

(511) 10

(210) No. 11907

(220) 30/09/2004

(732) ALTICOR INC

7575 Fulton Street East, Ada, Michigan

49355, United States of America

(111) No. 11449

(180) 30/09/2034

(540) Trademark Renewal

The Amway logo consists of the word "Amway" in a bold, sans-serif font. The letters are black with a white outline, giving it a 3D or embossed appearance. A thin, curved line underlines the word.

(511) 11

(210) No. 11908

(220) 30/09/2004

(732) ALTICOR INC

7575 Fulton Street East, Ada, Michigan

49355, United States of America

(111) No. 11450

(180) 30/09/2034

(540) Trademark Renewal



(511) 16

(210) No. 11909

(220) 30/09/2004

(732) ALTICOR INC

7575 Fulton Street East, Ada, Michigan

49355, United States of America

(111) No. 11451

(180) 30/09/2034

(540) Trademark Renewal



(511) 21

(210) No. 11910

(220) 30/09/2004

(732) ALTICOR INC

7575 Fulton Street East, Ada, Michigan

49355, United States of America

(111) No. 11452

(180) 30/09/2034

(540) Trademark Renewal

The Amway logo consists of the word "Amway" in a bold, sans-serif font. The letters are black with a white outline, giving it a 3D or embossed appearance. A thin, curved line underlines the word.

(511) 29

(210) No. 11911

(220) 30/09/2004

(732) ALTICOR INC

7575 Fulton Street East, Ada, Michigan  
49355, United States of America

(111) No. 11453

(180) 30/09/2034

(540) Trademark Renewal

The Amway logo consists of the word "Amway" in a bold, sans-serif font. The letters are black with a white outline, giving it a 3D or embossed appearance. A thin, curved line underlines the word.

(511) 30

(210) No. 11912

(220) 30/09/2004

(732) ALTICOR INC

7575 Fulton Street East, Ada, Michigan  
49355, United States of America

(111) No. 11454

(180) 30/09/2034

(540) Trademark Renewal

The Amway logo consists of the word "Amway" in a bold, sans-serif font. The letters are slightly shadowed, giving it a 3D appearance. A thin, curved line is positioned below the text, following its general shape.

(511) 32

(210) No. 11913

(220) 30/09/2004

(732) ALTICOR INC

7575 Fulton Street East, Ada, Michigan

49355, United States of America

(111) No. 11455

(180) 30/09/2034

(540) Trademark Renewal

The Amway logo consists of the word "Amway" in a bold, sans-serif font. The letters are slightly shadowed, giving it a 3D appearance. A thin, curved line is positioned below the text, following its general shape.

(511) 35

(210) No. 11914

(220) 30/09/2004

(732) ALTICOR INC

7575 Fulton Street East, Ada, Michigan

49355, United States of America

(111) No. 11456

(180) 30/09/2034



(540) Trademark Renewal

**VICTORIA'S  
SECRET**

(511) 25

(210) No. 20841

(220) 26/01/2010

(732) Victoria's Secret Stores Brand Management,  
LLC

4 Limited Parkway, Reynoldsburg, OH 43068,  
United States of America

(111) No. 20071

(180) 06/10/2030

(540) Trademark Renewal

**VICTORIA'S  
SECRET**

(511) 42

(210) No. 20842

(220) 26/01/2010

(732) Victoria's Secret Stores Brand Management,  
LLC

4 Limited Parkway, Reynoldsburg, OH 43068,  
United States of America

(111) No. 20072

(180) 06/10/2030

(540) Trademark Renewal



(511) 33

(210) No. 26236

(220) 23/04/2012

(732) Diageo Mexico Comercializadora, S.A. de  
C.V

Ejercito Nacional 843-B Torre Paseo, Posi 2,  
Colonia Granada, Miguel Hidalgo, Mexico  
DF, 11520, Mexico

(111) No. 25521

(180) 09/10/2032

(540) Trademark Renewal

**OctoPay**

(511) 36

(210) No. 27923

(220) 05/12/2012

(732) CIMB Group Sdn Bhd

Level 13, Menara CIMB, Jalan Stesen Sentral  
2, Kuala Lumpur Sentral, 50470 Kuala  
Lumpur, Malaysia

(111) No. 27673

(180) 26/11/2033

(540) Trademark Renewal



(511) 03

(210) No. 27939

(220) 05/12/2012

(732) HUGO BOSS Trade Mark Management

GmbH & Co., KG

Dieselstrasse 12, Metzingen 72555, Germany

(111) No. 27689

(180) 26/11/2033

(540) Trademark Renewal



(511) 12

(210) No. 28219

(220) 03/01/2013

(732) SHANDONG QILUN RUBBER CO., LTD

No. 262 Qingken Road, Rubber Industry

Zone, Dawang Town, Guangrao County,

Dongying City, Shandong Province, China

(111) No. 27935

(180) 09/12/2033

(540) Trademark Renewal

**JOHN WALKER &  
SONS ODYSSEY  
(word mark)**

(511) 33

(210) No. 28427

(220) 21/01/2013

(732) Diageo Brands B.V

Molenwerf 10-12, Amsterdam 1014 BG,

The Netherlands

(111) No. 28067

(180) 09/12/2033

(540) Trademark Renewal



(511) 17

(210) No. 27962

(220) 06/12/2012

(732) Solutia Singapore Pte. Ltd.

9 North Buona Vista Drive #0501,

The Metropolis, 138588, Singapore

(111) No. 28139

(180) 02/04/2034

(540) Trademark Renewal

**NEXEN**

(511) 01

(210) No. 28157

(220) 20/12/2012

(732) KOCH AGRONOMIC SERVICES, LLC

4111 East 37th Street North, Wichita, Kansas

67220, United States of America

(111) No. 28141

(180) 02/04/2034

(540) Trademark Renewal



(511) 03

(210) No. 27008

(220) 23/07/2012

(732) COLGATE-PALMOLIVE COMPANY

300 Park Avenue, New York, N.Y. 10022,

United States of America

(111) No. 28152

(180) 09/04/2034

(540) Trademark Renewal

LIANPU



(511) 32

(210) No. 27005

(220) 23/07/2012

(732) CHINA RESOURCES SNOW BREWERIES  
COMPANY LTD.

Room 306 China Resources Building, No. 8  
Jianguomen North Avenue, Dongcheng  
District, Beijing 100005, China

(111) No. 28155

(180) 09/04/2034

(540) Trademark Renewal

PANG LIN

(511) 09

(210) No. 27130

(220) 17/08/2012

(732) CPL GROUP PUBLIC COMPANY  
LIMITED

700 Moo 6, Sukhumvit Road, Bangpoo-Mai,  
Muang Samutprakan, Samutpran, Thailand

(111) No. 28166

(180) 10/04/2034

(540) Trademark Renewal



(511) 10

(210) No. 27131

(220) 17/08/2012

(732) CPL GROUP PUBLIC COMPANY  
LIMITED

700 Moo 6, Sukhumvit Road, Bangpoo-Mai,  
Muang Samutprakan, Samutprkan, Thailand

(111) No. 28167

(180) 10/04/2034

(540) Trademark Renewal



(511) 25

(210) No. 27132

(220) 17/08/2012

(732) CPL GROUP PUBLIC COMPANY  
LIMITED

700 Moo 6, Sukhumvit Road, Bangpoo-Mai,  
Muang Samutprakan, Samutprkan, Thailand

(111) No. 28168

(180) 10/04/2034

(540) Trademark Renewal



(511) 35

(210) No. 27133

(220) 17/08/2012

(732) CPL GROUP PUBLIC COMPANY  
LIMITED

700 Moo 6, Sukhumvit Road, Bangpoo-Mai,  
Muang Samutprakan, Samutprakan, Thailand

(111) No. 28169

(180) 10/04/2034

(540) Trademark Renewal



(511) 01

(210) No. 27170

(220) 23/08/2012

(732) DAIICHI SANKYO COMPANY, LIMITED  
3-5-1, Nihonbashi Honcho, Chuo-ku, Tokyo  
103-8426, Japan

(111) No. 28182

(180) 10/04/2034



(540) Trademark Renewal



(511) 05  
(210) No. 27171  
(220) 23/08/2012  
(732) DAIICHI SANKYO COMPANY, LIMITED  
3-5-1, Nihonbashi Honcho, Chuo-ku, Tokyo  
103-8426, Japan  
(111) No. 28183  
(180) 10/04/2034

(540) Trademark Renewal



(511) 01  
(210) No. 27172  
(220) 23/08/2012  
(732) DAIICHI SANKYO COMPANY, LIMITED  
3-5-1, Nihonbashi Honcho, Chuo-ku, Tokyo  
103-8426, Japan  
(111) No. 28184  
(180) 10/04/2034

(540) Trademark Renewal



(511) 05

(210) No. 27173

(220) 23/08/2012

(732) DAIICHI SANKYO COMPANY, LIMITED

3-5-1, Nihonbashi Honcho, Chuo-ku, Tokyo

103-8426, Japan

(111) No. 28185

(180) 10/04/2034

(540) Trademark Renewal

**Beautylabo**

(511) 03

(210) No. 27191

(220) 27/08/2012

(732) HOYU KABUSHIKI KAISHA (also trading

as Hoyu Co., Ltd)

501, Tohugawa 1-Chome, Higashi-Ku,

Nagoya-Shi, Aichi-Ken, Japan

(111) No. 28199

(180) 10/04/2034

(540) Trademark Renewal

**NS BLUESCOPE**

(511) 06

(210) No. 27193

(220) 28/08/2012

(732) BLUESCOPE STEEL LIMITED

Level 11, 120 Collins Street, Melbourne,  
Victoria, Australia

(111) No. 28200

(180) 10/04/2034

(540) Trademark Renewal

**NS BLUESCOPE**

(511) 19

(210) No. 27194

(220) 28/08/2012

(732) BLUESCOPE STEEL LIMITED

Level 11, 120 Collins Street, Melbourne,  
Victoria, Australia

(111) No. 28201

(180) 10/04/2034

(540) Trademark Renewal

**NS BLUESCOPE**

(511) 35

(210) No. 27195

(220) 28/08/2012

(732) BLUESCOPE STEEL LIMITED

Level 11, 120 Collins Street, Melbourne,  
Victoria, Australia

(111) No. 28202

(180) 10/04/2034

(540) Trademark Renewal

**NS BLUESCOPE**

(511) 37

(210) No. 27196

(220) 28/08/2012

(732) BLUESCOPE STEEL LIMITED

Level 11, 120 Collins Street, Melbourne,  
Victoria, Australia

(111) No. 28203

(180) 10/04/2034

(540) Trademark Renewal

**NS BLUESCOPE**

(511) 40

(210) No. 27197

(220) 28/08/2012

(732) BLUESCOPE STEEL LIMITED

Level 11, 120 Collins Street, Melbourne,  
Victoria, Australia

(111) No. 28204

(180) 10/04/2034

(540) Trademark Renewal

**NS BLUESCOPE  
STEEL**

(511) 06

(210) No. 27199

(220) 28/08/2012

(732) BLUESCOPE STEEL LIMITED

Level 11, 120 Collins Street, Melbourne,  
Victoria, Australia

(111) No. 28206

(180) 10/04/2034

(540) Trademark Renewal

**NS BLUESCOPE  
STEEL**

(511) 19

(210) No. 27200

(220) 28/08/2012

(732) BLUESCOPE STEEL LIMITED

Level 11, 120 Collins Street, Melbourne,  
Victoria, Australia

(111) No. 28207

(180) 10/04/2034

(540) Trademark Renewal

**NS BLUESCOPE  
STEEL**

(511) 35

(210) No. 27201

(220) 28/08/2012

(732) BLUESCOPE STEEL LIMITED

Level 11, 120 Collins Street, Melbourne,  
Victoria, Australia

(111) No. 28208

(180) 10/04/2034

(540) Trademark Renewal

**NS BLUESCOPE  
STEEL**

(511) 37

(210) No. 27202

(220) 28/08/2012

(732) BLUESCOPE STEEL LIMITED

Level 11, 120 Collins Street, Melbourne,  
Victoria, Australia

(111) No. 28209

(180) 10/04/2034

(540) Trademark Renewal

**NS BLUESCOPE  
STEEL**

(511) 40

(210) No. 27203

(220) 28/08/2012

(732) BLUESCOPE STEEL LIMITED

Level 11, 120 Collins Street, Melbourne,  
Victoria, Australia

(111) No. 28210

(180) 10/04/2034

(540) Trademark Renewal

**NS BLUESCOPE  
STEEL**

(511) 42

(210) No. 27204

(220) 28/08/2012

(732) BLUESCOPE STEEL LIMITED

Level 11, 120 Collins Street, Melbourne,  
Victoria, Australia

(111) No. 28211

(180) 10/04/2034

(540) Trademark Renewal

**NS BLUESCOPE  
LYSAGHT**

(511) 06

(210) No. 27205

(220) 28/08/2012

(732) BLUESCOPE STEEL LIMITED

Level 11, 120 Collins Street, Melbourne,  
Victoria, Australia

(111) No. 28212

(180) 10/04/2034



(540) Trademark Renewal

**NS BLUESCOPE  
LYSAGHT**

(511) 19

(210) No. 27206

(220) 28/08/2012

(732) BLUESCOPE STEEL LIMITED

Level 11, 120 Collins Street, Melbourne,  
Victoria, Australia

(111) No. 28213

(180) 10/04/2034

(540) Trademark Renewal

**NS BLUESCOPE  
LYSAGHT**

(511) 35

(210) No. 27207

(220) 28/08/2012

(732) BLUESCOPE STEEL LIMITED

Level 11, 120 Collins Street, Melbourne,  
Victoria, Australia

(111) No. 28214

(180) 10/04/2034

(540) Trademark Renewal

**NS BLUESCOPE  
LYSAGHT**

(511) 37

(210) No. 27208

(220) 28/08/2012

(732) BLUESCOPE STEEL LIMITED

Level 11, 120 Collins Street, Melbourne,  
Victoria, Australia

(111) No. 28215

(180) 10/04/2034

(540) Trademark Renewal

**NS BLUESCOPE  
LYSAGHT**

(511) 40

(210) No. 27209

(220) 28/08/2012

(732) BLUESCOPE STEEL LIMITED

Level 11, 120 Collins Street, Melbourne,  
Victoria, Australia

(111) No. 28216

(180) 10/04/2034

(540) Trademark Renewal

**NS BLUESCOPE  
LYSAGHT**

(511) 42

(210) No. 27210

(220) 28/08/2012

(732) BLUESCOPE STEEL LIMITED

Level 11, 120 Collins Street, Melbourne,  
Victoria, Australia

(111) No. 28217

(180) 10/04/2034

(540) Trademark Renewal

**NS BLUESCOPE  
COATED  
PRODUCTS**

(511) 06

(210) No. 27211

(220) 28/08/2012

(732) BLUESCOPE STEEL LIMITED

Level 11, 120 Collins Street, Melbourne,  
Victoria, Australia

(111) No. 28218

(180) 10/04/2034

(540) Trademark Renewal

**NS BLUESCOPE  
COATED  
PRODUCTS**

(511) 19

(210) No. 27212

(220) 28/08/2012

(732) BLUESCOPE STEEL LIMITED

Level 11, 120 Collins Street, Melbourne,  
Victoria, Australia

(111) No. 28219

(180) 10/04/2034

(540) Trademark Renewal

**NS BLUESCOPE  
COATED  
PRODUCTS**

(511) 35

(210) No. 27213

(220) 28/08/2012

(732) BLUESCOPE STEEL LIMITED

Level 11, 120 Collins Street, Melbourne,  
Victoria, Australia

(111) No. 28220

(180) 10/04/2034

(540) Trademark Renewal

**NS BLUESCOPE  
COATED  
PRODUCTS**

(511) 37

(210) No. 27214

(220) 28/08/2012

(732) BLUESCOPE STEEL LIMITED

Level 11, 120 Collins Street, Melbourne,  
Victoria, Australia

(111) No. 28221

(180) 10/04/2034

(540) Trademark Renewal

**NS BLUESCOPE  
COATED  
PRODUCTS**

(511) 40

(210) No. 27215

(220) 28/08/2012

(732) BLUESCOPE STEEL LIMITED

Level 11, 120 Collins Street, Melbourne,  
Victoria, Australia

(111) No. 28222

(180) 10/04/2034

(540) Trademark Renewal

**NS BLUESCOPE  
COATED  
PRODUCTS**

(511) 42

(210) No. 27216

(220) 28/08/2012

(732) BLUESCOPE STEEL LIMITED

Level 11, 120 Collins Street, Melbourne,  
Victoria, Australia

(111) No. 28223

(180) 10/04/2034

(540) Trademark Renewal

**NEW BALANCE**

(511) 25

(210) No. 27220

(220) 28/08/2012

(732) NEW BALANCE ATHLETICS, INC.

100 Guest Street, Boston MA 02135 ,  
United States of America

(111) No. 28225

(180) 10/04/2034

(540) Trademark Renewal

The logo consists of the letters 'IBDO' in a bold, sans-serif font. The letters are black with a white outline, giving them a 3D effect. A horizontal line is positioned below the letters, also with a white outline.

(511) 35

(210) No. 28319

(220) 04/01/2013

(732) Stichting BDO

Philiteaan 73, 5617 AM EINDHOVEN,  
The Netherlands, Netherlands Antilles

(111) No. 28252

(180) 18/06/2034

(540) Trademark Renewal

The logo consists of the letters 'IBDO' in a bold, sans-serif font. The letters are black with a white outline, giving them a 3D effect. A horizontal line is positioned below the letters, also with a white outline.

(511) 36

(210) No. 28320

(220) 04/01/2013

(732) Stichting BDO

Philiteaan 73, 5617 AM EINDHOVEN,  
The Netherlands, Netherlands Antilles

(111) No. 28253

(180) 18/06/2034

(540) Trademark Renewal

The logo consists of the letters 'BDO' in a bold, sans-serif font. The 'B' and 'D' are connected at the top, and the 'O' is separate. A thick horizontal line is positioned below the letters.

(511) 45

(210) No. 28321

(220) 04/01/2013

(732) Stichting BDO

Philiteaan 73, 5617 AM EINDHOVEN,  
The Netherlands, Netherlands Antilles

(111) No. 28254

(180) 18/06/2034

(540) Trademark Renewal



(511) 31

(210) No. 28353

(220) 08/01/2013

(732) TONGWEI AGRICULTURAL  
DEVELOPMENT CO., LTD.

No. 588, Middle Section, Tianfu Avenue,  
Chengdu High-Tech Zone, China (Sichuan)  
Pilot Free Trade Zone, China

(111) No. 28276

(180) 30/06/2034



(540) Trademark Renewal

**ORANGE**

(511) 35

(210) No. 28356

(220) 10/01/2013

(732) ORANGE BRAND SERVICES LIMITED

3 More London Riverside, London, SE1 2AQ,  
United Kingdom

(111) No. 28279

(180) 30/06/2034

(540) Trademark Renewal

**ORANGE**

(511) 37

(210) No. 28357

(220) 10/01/2013

(732) ORANGE BRAND SERVICES LIMITED

3 More London Riverside, London, SE1 2AQ,  
United Kingdom

(111) No. 28280

(180) 30/06/2034

(540) Trademark Renewal



(511) 35

(210) No. 28358

(220) 10/01/2013

(732) ORANGE BRAND SERVICES LIMITED

3 More London Riverside, London, SE1

2AQ, , United Kingdom

(111) No. 28281

(180) 30/06/2034

(540) Trademark Renewal



(511) 03

(210) No. 28409

(220) 17/01/2013

(732) PIGEON CORPORATION

4-4, Nihonbashi Hisamatsu-cho, Chuo-ku,

Japan

(111) No. 28293

(180) 30/06/2034

(540) Trademark Renewal



(511) 10

(210) No. 28410

(220) 17/01/2013

(732) PIGEON CORPORATION

4-4, Nihonbashi Hisamatsu-cho, Chuo-ku,  
Japan

(111) No. 28294

(180) 30/06/2034

(540) Trademark Renewal



(511) 21

(210) No. 28411

(220) 17/01/2013

(732) PIGEON CORPORATION

4-4, Nihonbashi Hisamatsu-cho, Chuo-ku,  
Tokyo, Japan

(111) No. 28295

(180) 30/06/2034

(540) Trademark Renewal

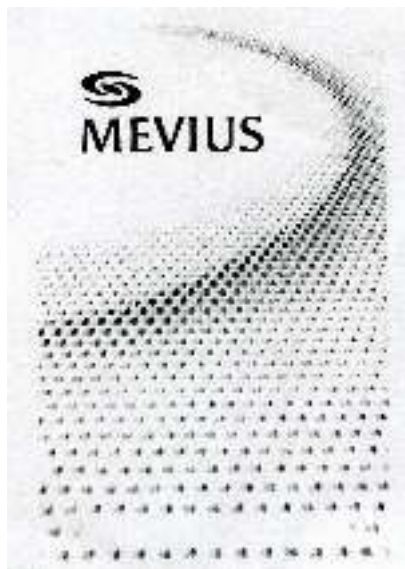

(511) 34

(210) No. 28513

(220) 25/01/2013

(732) Japan Tobacco Inc.

1-1, Toranomom 4-chome, Minato-ku,  
Tokyo,, Japan

(111) No. 28353

(180) 02/07/2034

(540) Trademark Renewal



(511) 09

(210) No. 23458

(220) 15/03/2011

(732) Netflix, Inc.

121 Albright Way, Los Gatos, CA 95032,  
United States of America

(111) No. 28375

(180) 17/07/2034

(540) Trademark Renewal



(511) 35

(210) No. 23459

(220) 15/03/2011

(732) Netflix, Inc.

121 Albright Way, Los Gatos, CA 95032,  
United States of America

(111) No. 28376

(180) 17/07/2034

(540) Trademark Renewal



(511) 38

(210) No. 23460

(220) 15/03/2011

(732) Netflix, Inc.

121 Albright Way, Los Gatos, CA 95032,  
United States of America

(111) No. 28377

(180) 17/07/2034

(540) Trademark Renewal



(511) 41

(210) No. 23461

(220) 15/03/2011

(732) Netflix, Inc.

121 Albright Way, Los Gatos, CA 95032,  
United States of America

(111) No. 28378

(180) 17/07/2034

(540) Trademark Renewal

**Sister hood**

(511) 25

(210) No. 28547

(220) 05/02/2013

(732) FULL MOON INTERTRADE CO., LTD

No. 488/447 the 4th Floor, Bobae Tower,  
Damrongrak Road, Khlong Maha Nak  
Sub-district, Pom Prap Sattru Phai District,  
Bangkok 10100, Thailand

(111) No. 28392

(180) 13/08/2034

(540) Trademark Renewal



(511) 06

(210) No. 28550

(220) 06/02/2013

(732) HOA SEN GROUP

No. 9, Thong Nhat Avenue, Song Than II  
Industrial Park, Di An Ward, Di An City,  
Binh Duong Province, Vietnam

(111) No. 28395

(180) 13/08/2034

(540) Trademark Renewal

**DIAPEX WONDER  
PANTS**

(511) 05

(210) No. 28573

(220) 08/02/2013

(732) NIBONG TEBAL PAPER MILL SDN. BHD

No. 886, Jalan Bandar Baru, Sungai Kecil,  
14300 Nibong Tebal, S.P.S., Pulau Pinang,  
Malaysia

(111) No. 28417

(180) 13/08/2034

(540) Trademark Renewal

**G-STAR**

(511) 18

(210) No. 28602

(220) 18/02/2013

(732) TM25 HOLDING B.V

Joan Muyskenweg 39, 1114 AN Amsterdam-  
Duivendrecht, The Netherlands

(111) No. 28444

(180) 13/08/2034

(540) Trademark Renewal

**G-STAR**

(511) 35

(210) No. 28603

(220) 18/02/2013

(732) TM25 HOLDING B.V

Joan Muyskenweg 39, 1114 AN Amsterdam-  
Duivendrecht, The Netherlands

(111) No. 28445

(180) 13/08/2034



(540) Trademark Renewal

**ONE-PUSH**

(511) 03

(210) No. 28604

(220) 19/02/2013

(732) FUMAKILLA ASIA SDN. BHD.

Plot No. 256, Tingkat Perusahaan 5, Kawasan  
Perindustrian Perai 2, 13600 Perai, Penang,  
Malaysia

(111) No. 28446

(180) 13/08/2034

(540) Trademark Renewal

**ONE-PUSH**

(511) 05

(210) No. 28605

(220) 19/02/2013

(732) FUMAKILLA ASIA SDN. BHD.

Plot No. 256, Tingkat Perusahaan 5, Kawasan  
Perindustrian Perai 2, 13600 Perai, Penang,  
Malaysia

(111) No. 28447

(180) 13/08/2034

(540) Trademark Renewal

**JACK**  
杰 克

(511) 07

(210) No. 28632

(220) 22/02/2013

(732) JACK TECHNOLOGY CO., LTD.

No.1008, East Donghai Avenue, Sanjia,  
Jiaojiang District, Taizhou City, Zhejiang  
Province, China

(111) No. 28472

(180) 13/08/2034

(540) Trademark Renewal

**PEJOY**

(511) 30

(210) No. 28653

(220) 27/02/2013

(732) EZAKI GLICO KABUSHIKI KAISHA

6-5, Utajima 4-chome, Nishiyodogawa-ku,  
Osaka, Japan

(111) No. 28492

(180) 13/08/2034

(540) Trademark Renewal

**Pocky**

(511) 30

(210) No. 28654

(220) 27/02/2013

(732) EZAKI GLICO KABUSHIKI KAISHA

6-5, Utajima 4-chome, Nishiyodogawa-ku,  
Osaka, Japan

(111) No. 28493

(180) 13/08/2034

(540) Trademark Renewal

**PREMIER WONDER  
PANTS**

(511) 05

(210) No. 28748

(220) 11/03/2013

(732) NIBONG TEBAL PAPER MILL SDN. BHD

No. 886, Jalan Bandar Baru, Sungai Kecil,  
14300 Nibong Tebal, S.P.S., Pulau Pinang,  
Malaysia

(111) No. 28581

(180) 29/08/2034

(540) Trademark Renewal

**THE LUXURY  
COLLECTION**

(511) 36

(210) No. 28765

(220) 11/03/2013

(732) SHERATON INTERNATIONAL IP, LLC  
7750 Wisconsin Avenue, Bethesda, Maryland  
20814, United States of America

(111) No. 28598

(180) 29/08/2034

(540) Trademark Renewal

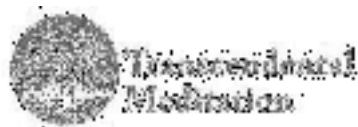

(511) 41

(210) No. 28771

(220) 12/03/2013

(732) Maharishi Vedic University Limited  
54 Triq Marsamxett, VLT 1853 Valletta,  
Malta

(111) No. 28604

(180) 29/08/2034

(540) Trademark Renewal

**Transcendental  
Meditation & Device**

(511) 41

(210) No. 28772

(220) 12/03/2013

(732) Maharishi Vedic University Limited

54 Triq Marsamxett, VLT 1853 Valletta,  
Malta

(111) No. 28605

(180) 29/08/2034

(540) Trademark Renewal

**RAW**

(511) 18

(210) No. 28773

(220) 12/03/2013

(732) TM25 Holding B.V.

Joan Muyskenweg 39, 1114 AN,  
AMSTERDAM-DUIVENDRECHT,  
THE NETHERLANDS

(111) No. 28606

(180) 29/08/2034

(540) Trademark Renewal

**RAW**

(511) 25

(210) No. 28774

(220) 12/03/2013

(732) TM25 Holding B.V.

Joan Muyskenweg 39, 1114 AN,  
AMSTERDAM-DUIVENDRECHT,  
The Netherlands

(111) No. 28607

(180) 29/08/2034

(540) Trademark Renewal

**RAW**

(511) 35

(210) No. 28775

(220) 12/03/2013

(732) TM25 Holding B.V.

Joan Muyskenweg 39, 1114 AN,  
AMSTERDAM-DUIVENDRECHT,  
THE NETHERLANDS

(111) No. 28608

(180) 29/08/2034

(540) Trademark Renewal



(511) 30

(210) No. 28788

(220) 12/03/2013

(732) EZAKI GLICO KABUSHIKI KAISHA

6-5, Utajima 4-chome, Nishiyodogawa-ku,  
Osaka, Japan

(111) No. 28621

(180) 29/08/2034

(540) Trademark Renewal



(511) 30

(210) No. 28789

(220) 12/03/2013

(732) EZAKI GLICO KABUSHIKI KAISHA

6-5, Utajima 4-chome, Nishiyodogawa-ku,  
Osaka, Japan

(111) No. 28622

(180) 29/08/2034

(540) Trademark Renewal



(511) 32

(210) No. 28805

(220) 14/03/2013

(732) Johnson & Johnson Pte. Ltd.

2 Science Park Drive # 07-13, Ascent

Singapore Science Park One, Singapore

118222, Singapore

(111) No. 28638

(180) 29/08/2034

(540) Trademark Renewal

**JEZETEK in stylized**

(511) 09

(210) No. 28817

(220) 15/03/2013

(732) SICHUAN JIUZHOU INVESTMENT

HOLDING GROUP CO., LTD.

NO.6, JIUHUA ROAD, SCIENCE AND

TECHNOLOGY BUSINESS PARK,

MIANYANG, SICHUAN, P. R. CHINA

(111) No. 28650

(180) 29/08/2034



(540) Trademark Renewal

**JEZETEK in stylized**

(511) 11

(210) No. 28818

(220) 15/03/2013

(732) SICHUAN JIUZHOU INVESTMENT  
HOLDING GROUP CO., LTD.

NO.6, JIUHUA ROAD, SCIENCE AND  
TECHNOLOGY BUSINESS PARK,  
MIANYANG, SICHUAN, P. R. CHINA

(111) No. 28651

(180) 29/08/2034

(540) Trademark Renewal

**Kumwell**

(511) 09

(210) No. 28874

(220) 25/03/2013

(732) KUMWELL CORPORATION PUBLIC  
COMPANY LIMITED

100/3 Thesabansongkrow Road, Lardyao,  
Jatujak, Bangkok 10900, Thailand

(111) No. 28702

(180) 29/08/2034

(540) Trademark Renewal

**BOTO & Device**

(511) 12

(210) No. 28891

(220) 26/03/2013

(732) SHANDONG WANDA BOTO TYRE CO.,  
LTD

No.68, YONGSHEN ROAD, KENLI

COUNTY, DONGYIING CITY, SHANDONG  
PROVINCE, CHINA

(111) No. 28718

(180) 29/08/2034

(540) Trademark Renewal



(511) 12

(210) No. 28892

(220) 26/03/2013

(732) SHANDONG WANDA BOTO TYRE CO.,  
LTD

No.68, YONGSHEN ROAD, KENLI

COUNTY, DONGYIING CITY,  
SHANDONG PROVINCE, CHINA

(111) No. 28719

(180) 29/08/2034

(540) Trademark Renewal



(511) 12

(210) No. 28893

(220) 26/03/2013

(732) SHANDONG WANDA BOTO TYRE CO.,  
LTD

No.68, YONGSHEN ROAD, KENLI  
COUNTY, DONGYIING CITY,  
SHANDONG PROVINCE, CHINA

(111) No. 28720

(180) 29/08/2034

(540) Trademark Renewal



(511) 12

(210) No. 28897

(220) 26/03/2013

(732) ANHUI HUALING AUTOMOBILE CO.,  
LTD

Maanshan Economic and Technological  
Development Zone, Anhui, China

(111) No. 28724

(180) 29/08/2034

(540) Trademark Renewal



(511) 25

(210) No. 28923

(220) 01/04/2013

(732) BEER CHANG COMPANY LIMITED

15 Moo 14, Vibhavadi Rangsit Road,

Chomphon Sub-District, Chatuchak District,

Bangkok 10900, Thailand

(111) No. 28748

(180) 04/09/2034

(540) Trademark Renewal



(511) 32

(210) No. 28924

(220) 01/04/2013

(732) BEER CHANG COMPANY LIMITED

15 Moo 14, Vibhavadi Rangsit Road,

Chomphon Sub-District, Chatuchak District,

Bangkok 10900, Thailand

(111) No. 28749

(180) 04/09/2034

(540) Trademark Renewal

**Chang**

(511) 25

(210) No. 28925

(220) 01/04/2013

(732) BEER CHANG COMPANY LIMITED

15 Moo 14, Vibhavadi Rangsit Road,  
Chomphon Sub-District, Chatuchak District,  
Bangkok 10900, Thailand

(111) No. 28750

(180) 04/09/2034

(540) Trademark Renewal

**Chang**

(511) 32

(210) No. 28926

(220) 01/04/2013

(732) BEER CHANG COMPANY LIMITED

15 Moo 14, Vibhavadi Rangsit Road,  
Chomphon Sub-District, Chatuchak District,  
Bangkok 10900, Thailand

(111) No. 28751

(180) 04/09/2034

(540) Trademark Renewal



(511) 25

(210) No. 28927

(220) 01/04/2013

(732) SURA BANGYIKHAN COMPANY  
LIMITED

82 Moo 3 Tambol Bangkuwat, Amphur  
Muang Pathumthani, Pathumthani Province  
12000, Thailand

(111) No. 28752

(180) 04/09/2034

(540) Trademark Renewal



(511) 33

(210) No. 28928

(220) 01/04/2013

(732) SURA BANGYIKHAN COMPANY  
LIMITED

82 Moo 3 Tambol Bangkuwat, Amphur  
Muang Pathumthani, Pathumthani Province  
12000, Thailand

(111) No. 28753

(180) 04/09/2034

(540) Trademark Renewal



(511) 32

(210) No. 28932

(220) 01/04/2013

(732) ARCHA BEER COMPANY LIMLTD

14 Vibhavadee Rangsit Road, Chomphon  
Sub-District, Chatuchak District, Bangkok  
10900, Thailand

(111) No. 28757

(180) 04/09/2034

(540) Trademark Renewal



(511) 31

(210) No. 28985

(220) 05/04/2013

(732) ບໍລິສັດ ຄວາມຫວັງໃຫມ່ລາວ ຈຳກັດຜູ້ດຽວ  
ເຂດພັດທະນາກວມລວມໄຊເສດຖາ, ບ້ານ ນາໂນ,  
ເມືອງ ໄຊເສດຖາ, ນະຄອນຫລວງວຽງຈັນ, ສປປ ລາວ

(111) No. 28810

(180) 04/09/2034

(540) Trademark Renewal



(511) 05

(210) No. 28986

(220) 05/04/2013

(732) ບໍລິສັດ ຄວາມຫວັງໃຫມ່ລາວ ຈຳກັດຜູ້ດຽວ.  
ເຂດພັດທະນາກວມລວມໄຊເສດຖາ, ບ້ານ ນາໂນ,  
ເມືອງ ໄຊເຊດຖາ, ນະຄອນຫລວງວຽງຈັນ, ສປປ ລາວ.

(111) No. 28811

(180) 04/09/2034

(540) Trademark Renewal



(511) 43

(210) No. 28987

(220) 05/04/2013

(732) ບໍລິສັດ ຄວາມຫວັງໃຫມ່ລາວ ຈຳກັດຜູ້ດຽວ.  
ເຂດພັດທະນາກວມລວມໄຊເສດຖາ, ບ້ານ ນາໂນ,  
ເມືອງ ໄຊເຊດຖາ, ນະຄອນຫລວງວຽງຈັນ, ສປປ ລາວ.

(111) No. 28812

(180) 04/09/2034



(540) Trademark Renewal



(511) 36

(210) No. 29009

(220) 09/04/2013

(732) CIMB Group Sdn Bhd

Level 13, Menara CIMB, Jalan Stesen Sentral  
2, Kuala Lumpur Sentral, 50470 Kuala  
Lumpur, Malaysia

(111) No. 28819

(180) 04/09/2034

(540) Trademark Renewal



(511) 30

(210) No. 29137

(220) 23/04/2013

(732) HOANG MAI TRADING AND

PRODUCTION COMPANY LIMITED  
P204-C3-34A, Tran Phu Street. Ba Dinh  
District, Hanoi, Vietnam

(111) No. 28945

(180) 04/09/2034

(540) Trademark Renewal



(511) 09

(210) No. 29147

(220) 25/04/2013

(732) New-Star Genuine Parts Co., Ltd

152-152/1 Trokwatsamngam, Rama 6 Road,  
Rongmuang, Patumwan, Bangkok 10330,  
Thailand

(111) No. 28955

(180) 04/09/2034

(540) Trademark Renewal

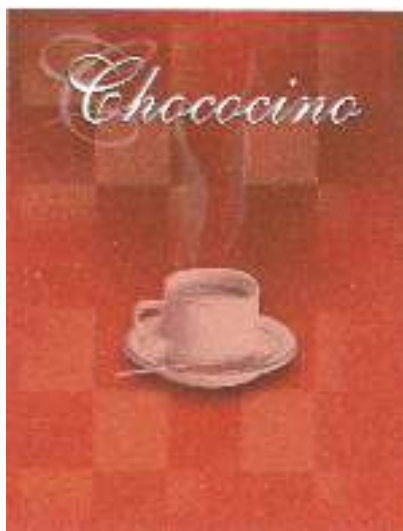

(511) 30

(210) No. 29170

(220) 30/04/2013

(732) P.T. SARI INCOFOOD CORPORATION

Desa Tanjung Morawa B, Kabupaten Deli  
Serdang, Sumatera Utara, Indonesia

(111) No. 28978

(180) 04/09/2034

(540) Trademark Renewal

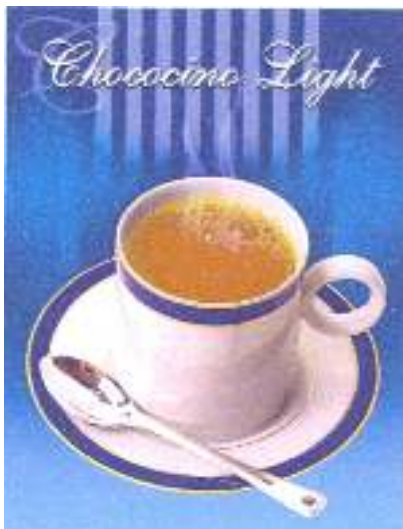

(511) 30

(210) No. 29171

(220) 30/04/2013

(732) P.T. SARI INCOFOOD CORPORATION

Desa Tanjung Morawa B, Kabupaten Deli  
Serdang, Sumatera Utara, Indonesia

(111) No. 28979

(180) 04/09/2034

(540) Trademark Renewal



(511) 05

(210) No. 29217

(220) 09/05/2013

(732) FUMAKILLA ASIA SDN. BHD.

Plot No. 256, Tingkat Perusahaan 5, Kawasan  
Perindustrian Perai 2, 13600 Perai, Penang,  
Malaysia

(111) No. 29025

(180) 08/10/2034

(540) Trademark Renewal



(511) 19

(210) No. 29257

(220) 20/05/2013

(732) THE FIRST CHEMICAL PLASTIC CO.,  
LTD

B02 Lot, No. 3 Street, Duc Hoa 1 Industrial  
Zone, Hamlet 5th, Duc Hoa Dong Village,  
Duc Hoa District, Long An Province,  
Vietnam

(111) No. 29064

(180) 08/10/2034

(540) Trademark Renewal



(511) 19

(210) No. 29258

(220) 20/05/2013

(732) THE FIRST CHEMICAL PLASTIC CO.,  
LTD

B02 Lot, No. 3 Street, Duc Hoa 1 Industrial  
Zone, Hamlet 5th, Duc Hoa Dong Village,  
Duc Hoa District, Long An Province,  
Vietnam

(111) No. 29065

(180) 08/10/2034

(540) Trademark Renewal



(511) 34

(210) No. 29730

(220) 22/07/2013

(732) NANYANG BROTHERS TOBACCO  
COMPANY LIMITED

9 Tsing Yeung Circuit, Tuen Mun,  
New Territories, Hong Kong

(111) No. 29496

(180) 01/12/2034

(540) Trademark Renewal



(511) 34

(210) No. 29731

(220) 22/07/2013

(732) NANYANG BROTHERS TOBACCO  
COMPANY LIMITED

9 Tsing Yeung Circuit, Tuen Mun,  
New Territories, Hong Kong

(111) No. 29497

(180) 01/12/2034

(540) Trademark Renewal

**EAGLE**

(511) 09

(210) No. 29845

(220) 02/08/2013

(732) DRY CELL AND STORAGE BATTERY

JOINT STOCK COMPANY

321 Tran Hung Dao Street, Co Giang Ward,  
District 1, Ho Chi Minh City, Vietnam

(111) No. 29605

(180) 03/12/2034

(540) Trademark Renewal



(511) 09

(210) No. 29890

(220) 06/08/2013

(732) LONG AN HOANH KIEN DAT

ELECTRICAL APPLIANCE COMPANY

LIMITED

Hai Son Industrial Park, Binh Tien 2 Hamlet,  
Due Hoa Ha commune, Due Hoa District,  
Long An Province, Vietnam

(111) No. 29646

(180) 03/12/2034

(540) Trademark Renewal



(511) 11

(210) No. 29891

(220) 06/08/2013

(732) LONG AN HOANH KIEN DAT  
ELECTRICAL APPLIANCE COMPANY  
LIMITED

Hai Son Industrial Park, Binh Tien 2 Hamlet,  
Duc Hoa Ha commune, Duc Hoa District,  
Long An Province, Vietnam

(111) No. 29647

(180) 03/12/2034

(540) Trademark Renewal



(511) 03

(210) No. 29978

(220) 09/08/2013

(732) THE MENTHOLATUM COMPANY  
707 Sterling Drive, Orchard Park, New York  
14127-1587, United States of America

(111) No. 29734

(180) 04/12/2034

(540) Trademark Renewal



(511) 12

(210) No. 30929

(220) 03/12/2013

(732) Black Donut Company Limited

No.1448, Srinagarinda Road, On Nut Sub-District, Suan Luang District, Bangkok, Thailand

(111) No. 30632

(180) 18/12/2034

(540) Trademark Renewal

**KUHN**

(511) 07

(210) No. 31612

(220) 11/03/2014

(732) KUHN SAS

4 Impasse des Fabriques, 67700 Saverne, France

(111) No. 31895

(180) 06/04/2035



(540) Trademark Renewal

**FUSO**

(511) 12

(210) No. 10906

(220) 12/01/2004

(732) MITSUBISHI FUSO TRUCK AND BUS  
CORPORATION

1-1-2, Kashimada, Saiwai-Ku, kawasaki-Shi,  
Kanagawa 212-0058, Japan

(111) No. 33416

(180) 12/01/2034

(540) Trademark Renewal

**WESTERN  
UNION** |

(511) 36

(210) No. 11001

(220) 09/02/2004

(732) WESTERN UNION HOLDINGS, INC.

7001 East Belleview Avenue, Denver,

Colorado, 80237, United States of America

(111) No. 61052

(180) 04/09/2044

**ພາກທີ III**

**(Part III)**

**ເຄື່ອງໝາຍການຄ້າ**

**Trademarks**

**4. ການປ່ຽນແປງ**

**(Changes)**

**ພາກທີ III**  
**(Part III)**  
**ເຄື່ອງໝາຍການຄ້າ**  
**Trademarks**

**5. ການດັດແກ້**  
**(Amendments)**

## ພາກທີ IV

### (Part IV)

#### ເຄື່ອງໝາຍການຄ້າຜ່ານລະບົບມາດຣິດ

### Trademarks via Madrid Protocol

#### 1. ຄໍາຮ້ອງ

#### (Applications)

##### ຄໍາອະທິບາຍກ່ຽວກັບລະຫັດຫຍໍ້

##### (Introduction of Codes)

- (540) ເຄື່ອງໝາຍການຄ້າ (Trademark)
- (511) ໝວດ (Nice Classification)
- (210) ເລກທີ ຄໍາຮ້ອງ (Number of the application)
- (220) ວັນທີ ຄໍາຮ້ອງ (Date of filing of the application)
- (732) ຊື່ ແລະ ທີ່ຢູ່ ຂອງຜູ້ຍື່ນຄໍາຮ້ອງ (Name and Address of applicant)

(540)Madrid Application

**GUNZE**

(511) 10

(210) No. M/1298543

(220) 27/06/2024

(732) GUNZE LIMITED

No. 1, Zeze, Aono-cho, Ayabe-shi Kyoto  
623-8511, Japan

(540)Madrid Application

**養生堂**

(511) 05

(210) No. M/1588883

(220) 09/08/2024

(732) YANGSHENGTANG CO., LTD.

Room 205, No. 17 Lundu Road, Shuangpu  
Town, Xihu District, Hangzhou 310013  
Zhejiang, China

(540)Madrid Application

**METAFOLIN**

(511) 05

(210) No. M/1624646

(220) 07/08/2024

(732) Merck KGaA

Frankfurter Str. 250 64293 Darmstadt,  
Germany

(540)Madrid Application

**MIAMI LIFE**

(511) 41

(210) No. M/1710536

(220) 26/07/2024

(732) GR OPCO, LLC

29 NE 11th Street Miami FL 33132,  
United States of America

(540)Madrid Application

龙蟠

(511) 01 and 04

(210) No. M/1785012

(220) 26/07/2024

(732) JIANGSU LOPAL TECH CO., LTD.

6 Hengtong Avenue, Nanjing Economic and  
Technological Development Zone, Nanjing  
211000 Jiangsu Province, China

(540)Madrid Application



(511) 17 and 19

(210) No. M/1805221

(220) 11/04/2024

(732) Maxell, Ltd.

1 Koizumi, Oyamazaki, Oyamazaki-cho,  
Otokuni-gun Kyoto 618-8525, Japan

(540)Madrid Application

**OUT OF CORE**

(511) 09, 18 and 25

(210) No. M/1805257

(220) 19/06/2024

(732) INDUSTRIA DE DISEÑO TEXTIL, S.A.

(INDITEX, S.A.)

Avenida de la Diputación, "Edificio Inditex"

E-15142 Arteixo (A Coruña), Spain

(540)Madrid Application

**APPLE SPORTS**

(511) 09

(210) No. M/1805286

(220) 01/06/2024

(732) Apple Inc.

One Apple Park Way Cupertino CA 95014,

United States of America



(540)Madrid Application

**CHAGEE**

(511) 30, 32, 35 and 43

(210) No. M/1805363

(220) 12/06/2024

(732) CHAGEE INVESTMENT PTE. LTD.

987 SERANGOON ROAD SINGAPORE

(540)Madrid Application

**MIAMI BORN &  
BRED**

(511) 25 and 33

(210) No. M/1805418

(220) 12/07/2024

(732) GR OPCO, LLC

29 N.E. 11th Street Miami FL 33132,

United States of America

(540)Madrid Application

**10 BURNING CLOVER**

(511) 09, 28, 41 and 42

(210) No. M/1805428

(220) 05/03/2024

(732) Euro Games Technology Ltd.

"Maritsa" Str. 4, "Vranya-Lozen-Triugulnika"

BG-1151 Sofia, Bulgaria

(540)Madrid Application

**5 SUPER FRUITS**

(511) 09, 28, 41 and 42

(210) No. M/1805429

(220) 05/03/2024

(732) Euro Games Technology Ltd.

"Maritsa" Str. 4, "Vranya-Lozen-Triugulnika"

BG-1151 Sofia, Bulgaria

(540)Madrid Application

The logo for Liny & Leaf features the brand name in a stylized, serif font. The 'y' in 'Liny' has a small leaf-like shape above it, and the 'f' in 'Leaf' has a small leaf-like shape above it. The ampersand is also stylized.

(511) 03

(210) No. M/1805438

(220) 04/06/2024

(732) BLUE ORIGIN MANAGEMENT  
CONSULTANT PTE. LTD.

73 UPPER PAYA LEBAR ROAD, #07-02J  
CENTRO BIANCO SINGAPORE 534818

(540)Madrid Application



(511) 38

(210) No. M/1805453

(220) 01/07/2024

(732) Real world asset Inc.

16F, 701 Yeongdong-daero, Gangnam-gu  
Seoul 06072, Republic of Korea

(540)Madrid Application

**PARTY  
AMBITIOUSLY**

(511) 25 and 33

(210) No. M/1805483

(220) 12/07/2024

(732) GR OPCO, LLC

29 N.E. 11th Street Miami FL 33132,  
United States of America

(540)Madrid Application



(511) 35, 39, 41 and 43

(210) No. M/1805491

(220) 18/06/2024

(732) H WORLD HOLDINGS SINGAPORE PTE.  
LTD.

11 PENANG LANE, JI HOTEL ORCHARD  
SINGAPORE SINGAPORE 238485

(540)Madrid Application

**MACOS SEQUOIA**

(511) 09

(210) No. M/1805496

(220) 16/07/2024

(732) Apple Inc.

One Apple Park Way Cupertino CA 95014,  
United States of America

(540)Madrid Application

 **Sports**

(511) 09

(210) No. M/1805606

(220) 10/07/2024

(732) Apple Inc.

One Apple Park Way Cupertino CA 95014,  
United States of America

(540)Madrid Application

**ULTRA RETINA  
XDR**

(511) 09

(210) No. M/1805613

(220) 17/07/2024

(732) Apple Inc.

One Apple Park Way Cupertino CA 95014,  
United States of America

(540)Madrid Application

**MEETMOLLY**

(511) 03

(210) No. M/1805663

(220) 05/06/2024

(732) BLUE ORIGIN MANAGEMENT

CONSULTANT PTE. LTD.

73 UPPER PAYA LEBAR ROAD, #07-02J

CENTRO BIANCO SINGAPORE 534818

(540)Madrid Application

立邦

(511) 02 and 37

(210) No. M/1805680

(220) 13/06/2024

(732) NIPPON PAINT HOLDINGS SG PTE. LTD.

16 RAFFLES QUAY, #17-03 HONG

LEONG BUILDING SINGAPORE 048581

(540)Madrid Application

鲁驰

(511) 12

(210) No. M/1805704

(220) 08/04/2024

(732) Shandong Feichi Automobile Co., Ltd

Liangshan Town Industrial Park, Liangshan

County, Jining City 272600 Shandong

Province, China

(540)Madrid Application



(511) 08 and 21

(210) No. M/1805712

(220) 03/06/2024

(732) BLUE ORIGIN MANAGEMENT  
CONSULTANT PTE. LTD.

73 UPPER PAYA LEBAR ROAD, #07-02J  
CENTRO BIANCO SINGAPORE 534818

(540)Madrid Application

**HM.CLAUSE**

(511) 31

(210) No. M/1805737

(220) 28/06/2024

(732) HM.CLAUSE

RUE LOUIS SAILLANT, ZI LA MOTTE, F-  
26800 PORTES-LES-VALENCE, FRANCE



(540)Madrid Application

**captueaty**

(511) 03

(210) No. M/1805741

(220) 04/06/2024

(732) BLUE ORIGIN MANAGEMENT  
CONSULTANT PTE. LTD.

73 UPPER PAYA LEBAR ROAD, #07-02J  
CENTRO BIANCO SINGAPORE 534818

(540)Madrid Application

**ZDMG**

(511) 07

(210) No. M/1805743

(220) 26/07/2024

(732) Jiangxi ZDMG Technology Co., Ltd.

No. 16-17, Cable Industrial Park, Economic  
Development Zone, Guixi City Jiangxi  
Province, China

(540)Madrid Application

**OceanBlue**

(511) 09

(210) No. M/1805777

(220) 27/03/2024

(732) JingAo Solar Co., Ltd.

Jinglong Street, Ningjin County, Xingtai  
Hebei Province, China

(540)Madrid Application

**TOTAL**

(511) 20

(210) No. M/1805820

(220) 24/07/2024

(732) TOTAL TOOLS CO., PTE. LTD.

60 PAYA LEBAR ROAD, #11-01 PAYA  
LEBAR SQUARE SINGAPORE 409051

(540)Madrid Application

The logo for 'narka' is written in a bold, lowercase, sans-serif font.

(511) 03

(210) No. M/1805828

(220) 11/07/2024

(732) Uncommonhome Incorporation

3F, 36, Jahamun-ro, Jongno-gu Seoul 03044,  
Republic of Korea

(540)Madrid Application

The logo for 'SLOWZONE' features the word 'SLOWZONE' in a serif font. The 'O' is stylized with a plus sign inside, and the 'Z' has a plus sign above it. The 'E' has a plus sign above it.

(511) 03 and 04

(210) No. M/1805882

(220) 04/06/2024

(732) BLUE ORIGIN MANAGEMENT

CONSULTANT PTE. LTD.

73 UPPER PAYA LEBAR ROAD, #07-02J  
CENTRO BIANCO SINGAPORE 534818

(540)Madrid Application



**CHOPERI**

(511) 03

(210) No. M/1805883

(220) 04/06/2024

(732) BLUE ORIGIN MANAGEMENT  
CONSULTANT PTE. LTD.

73 UPPER PAYA LEBAR ROAD, #07-02J  
CENTRO BIANCO SINGAPORE 534818

(540)Madrid Application



**MISECR**  
**五月私语**

(511) 05

(210) No. M/1805884

(220) 07/05/2024

(732) INSOFTEB (CHINA) CO., LTD

Zhizao Avenue (Food Garden), Economy  
Development Zone, Jinjiang City, Quanzhou  
City Fujian Province, China

(540)Madrid Application



(511) 30

(210) No. M/1805885

(220) 05/06/2024

(732) Quanzhou taiwanese investment zone shihang trading co., ltd

Yudu Sunshine Commercial and Residential Community, Zhangban Town, Quanzhou Taiwanese Investment Zone, Quanzhou 362000 Fujian Province, China

(540)Madrid Application



(511) 33

(210) No. M/1805888

(220) 15/05/2024

(732) SHEDE SPIRITS CO., LTD.

999 TUOPAI AVENUE, TUOPAI TOWN, SHEHONG COUNTY, SUINING CITY 629000 SICHUAN PROVINCE, CHINA

(540)Madrid Application

Scent+viva

(511) 03

(210) No. M/1805891

(220) 04/06/2024

(732) BLUE ORIGIN MANAGEMENT  
CONSULTANT PTE. LTD.

73 UPPER PAYA LEBAR ROAD, #07-02J  
CENTRO BIANCO SINGAPORE 534818

(540)Madrid Application

everborn

(511) 03

(210) No. M/1805892

(220) 04/06/2024

(732) BLUE ORIGIN MANAGEMENT  
CONSULTANT PTE. LTD.

73 UPPER PAYA LEBAR ROAD, #07-02J  
CENTRO BIANCO SINGAPORE 534818

(540)Madrid Application



(511) 03

(210) No. M/1805893

(220) 04/06/2024

(732) BLUE ORIGIN MANAGEMENT  
CONSULTANT PTE. LTD.

73 UPPER PAYA LEBAR ROAD, #07-02J  
CENTRO BIANCO SINGAPORE 534818

(540)Madrid Application



(511) 28

(210) No. M/1805894

(220) 04/06/2024

(732) BLUE ORIGIN MANAGEMENT  
CONSULTANT PTE. LTD.

73 UPPER PAYA LEBAR ROAD, #07-02J  
CENTRO BIANCO SINGAPORE 534818

(540)Madrid Application

**AgriS Global**

(511) 30, 32 and 35

(210) No. M/1805900

(220) 20/07/2024

(732) AGRIS GLOBE PTE. LTD.

60 PAYA LEBAR ROAD, #10-52 PAYA  
LEBAR SQUARE SINGAPORE 409051

(540)Madrid Application

  
**OWNDAYS**

(511) 09 and 35

(210) No. M/1805904

(220) 25/04/2024

(732) OWNDAYS SINGAPORE PTE. LTD.

P.O. BOX 350, TANJONG PAGAR POST  
OFFICE SINGAPORE 910812



(540)Madrid Application

**JIDU**

(511) 09 and 37

(210) No. M/1805907

(220) 15/05/2024

(732) SHANGHAI JIDU AUTOMOBILE CO.,  
LTD.

Building 2, No. 1688 Yecheng Road, Jiading  
District Shanghai, China

(540)Madrid Application

**柒先生**

(511) 25

(210) No. M/1805908

(220) 12/06/2024

(732) Fujian Seven Brand Fashion & Technology  
Co., Ltd.

No. 1 Seven Brand Fashion Industry Park,  
Yinglin Town, Jinjiang City Fujian Province,  
China

(540)Madrid Application

**JASMINESTAR**

(511) 18

(210) No. M/1805910

(220) 23/05/2024

(732) Yiwu Ruike Luggage Co., Ltd.

Rm 103, Unit 1, Building 3, Zone 1 Duantou,  
Jiangdong St, Yiwu 322000 Zhejiang, China

(540)Madrid Application

**不莱玫**

(511) 18

(210) No. M/1805911

(220) 11/05/2024

(732) JIAXING BU LAI MEI INFORMATION  
TECHNOLOGY CO., LIMITED.

B1, Building 2, Jiaobao Group Cultural  
Industrial Park, No. 362 Fuxing Road, Nanhu  
District, Jiaxing Zhejiang Province, China

(540)Madrid Application

泰志辉材

(511) 17

(210) No. M/1805913

(220) 20/05/2024

(732) Taizhou Zhihui New Material Technology  
Co., Ltd.

Room 211 and 212, Building B, Block 18,  
Block Street Co construction Zone, No. 66  
Meilan East Road, Hailing Industrial Park,  
Hailing District, Taizhou City Jiangsu  
Province, China

(540)Madrid Application

HAN'S

(511) 07, 09 and 11

(210) No. M/1805916

(220) 13/05/2024

(732) HAN'S LASER TECHNOLOGY  
INDUSTRY GROUP CO., LTD.

No. 9988 Shennan Avenue, Nanshan District,  
Shenzhen 518000 GuangDong, China

(540)Madrid Application



(511) 01, 02 and 06

(210) No. M/1805950

(220) 04/06/2024

(732) GPM BINH THUAN COMPANY LIMITED  
HONG CHINH HAMLET, HOA THANG  
COMMUNE, BAC BINH DISTRICT BINH  
THUAN PROVINCE, VIETNAM

(540)Madrid Application



(511) 38, 41 and 42

(210) No. M/1806055

(220) 27/05/2024

(732) MONTECY HOLDING LTD  
Filippou, 11, Agios Dometios CY-2363  
Nicosia, Cyprus

(540)Madrid Application



(511) 09, 28, 41 and 42

(210) No. M/1806089

(220) 05/03/2024

(732) Euro Games Technology Ltd.

"Maritsa" Str. 4, "Vranya-Lozen-Triugulnika"

BG-1151 Sofia, Bulgaria

(540)Madrid Application



(511) 34

(210) No. M/1806105

(220) 19/04/2024

(732) PT MAKMUR TEMBAKAU

INTERNASIONAL

Jl. Yos Sudarso, Komplek Union Industrial

Park No. H12B, Batu Ampar, Batam

Kepulauan Riau, Indonesia

(540)Madrid Application



(511) 03

(210) No. M/1806128

(220) 02/07/2024

(732) Ishizawa Laboratories Inc.

4-4-9 Jingumae, Shibuya-ku Tokyo

150-0001, Japan

(540)Madrid Application



(511) 09

(210) No. M/1806147

(220) 20/05/2024

(732) Suzhou Woor Stronger Magnets Co., Ltd.

Rm 6012, F6, Future Workshop, No.1008

Xiugu Rd, Huangqiao St, Xiangcheng Dist,

Suzhou 215100 Jiangsu, China

(540)Madrid Application



(511) 43

(210) No. M/1806150

(220) 18/06/2024

(732) Guangzhou Huahui Lachang Catering  
Management Co., Ltd.

Room 308, Building G5, Ruihe Road No. 39,  
Huangpu District, Guangzhou Guangdong  
Province, China

(540)Madrid Application

**HWHG**

(511) 06

(210) No. M/1806204

(220) 20/06/2024

(732) Hongwang Holding Group Co., Ltd.

Unit 202-1, Block A1, Sanshan Sci-Tech  
Innovation Center, 12 Gangkou Rd.,  
Guicheng Street, Nanhai District, Foshan City  
Guangdong, China

(540)Madrid Application



(511) 01 and 17

(210) No. M/1806205

(220) 18/06/2024

(732) Shandong Ruian Biotechnology Co., Ltd.  
New Material Park, Huji Town, Jinxiang  
County, Jining City Shandong Province,  
China

(540)Madrid Application

**Bolden**

(511) 12

(210) No. M/1806206

(220) 16/05/2024

(732) China National Heavy Duty Truck Group  
Co., Ltd.  
Sinotruk Tower, No. 777 Hua'ao Road,  
Innovation Zone, Jinan 250101 Shandong,  
China



(540)Madrid Application

**Schoeller**

(511) 23, 24 and 25

(210) No. M/0609100

(220) 15/08/2024

(732) Schoeller Textil AG

Bahnhofstrasse CH-9475 Sevelen,  
Switzerland

(540)Madrid Application

**VEGAFINA**

(511) 34

(210) No. M/0644451

(220) 27/08/2024

(732) Tabacalera SL

Via de los Poblados, 3 Edificio 7,  
Plantas 3 y 4 Madrid, Spain

(540)Madrid Application

**Metafolin**

(511) 01 and 05

(210) No. M/0717715

(220) 07/08/2024

(732) Merck KGaA

Frankfurter Strasse 250 64293 Darmstadt,  
Germany

(540)Madrid Application

**CASELLA**

(511) 33

(210) No. M/0838596

(220) 22/07/2024

(732) Casella Wines Pty Limited

Farm 1471 Wakley Road Yenda NSW 2681,  
Australia

(540)Madrid Application

The logo consists of the letters 'CNC' in a bold, black, sans-serif font. The 'C' is a simple block letter, while the 'N' and 'C' have a slightly more stylized, modern appearance with a slight gap between the vertical strokes.

(511) 09

(210) No. M/0857488

(220) 08/08/2024

(732) Changcheng Electrical Group Zhejiang  
Technology Co.,Ltd

Hutou Industrial Zone, Liushi Town,  
Yueqing Clty Zhejiang Province, China

(540)Madrid Application

The logo consists of the letters 'BEIFA' in a bold, grey, sans-serif font. The letters are blocky and evenly spaced.

(511) 16

(210) No. M/1058186

(220) 27/06/2024

(732) BEIFA GROUP CO., LTD

No. 298 Jiangnan Road (East), Beilun,  
Ningbo 315801 ZHEJIANG, China

(540)Madrid Application

**Aoteli**

(511) 12

(210) No. M/1208290

(220) 30/07/2024

(732) Tercelo Tire (Qingzhou) Co., Ltd.

No. 7777, North Linglongshan Road,

Qingzhou Economic Development Zone,

Weifang City Shandong Province, China

(540)Madrid Application

**LEKI**

(511) 18, 25 and 28

(210) No. M/1221913

(220) 16/08/2024

(732) LEKI Lenhart GmbH

Karl-Arnold-Strasse 30 73230 Kirchheim,

Germany

(540)Madrid Application

**ARVA**

(511) 43

(210) No. M/1396990

(220) 29/08/2024

(732) Aman Group S.à.r.l.

Grabenstrasse 17 CH-6340 Baar, Switzerland

(540)Madrid Application

**PLANSTAR**

(511) 01

(210) No. M/1401499

(220) 01/08/2024

(732) PLANTIN

Usine de la Rolande F-84350

COURTHEZON, France

(540)Madrid Application

**FOLIAPLANT**

(511) 01

(210) No. M/1524260

(220) 31/07/2024

(732) PLANTIN

Usine de la Rolande F-84350

COURTHEZON, France

(540)Madrid Application



(511) 33

(210) No. M/1536079

(220) 13/08/2024

(732) MARTELL & CO

Place Edouard Martell F-16100 COGNAC,

France

(540)Madrid Application

**REFEEL**

(511) 03 and 05  
(210) No. M/1571382  
(220) 08/08/2024  
(732) IDI Integratori Dietetici Italiani S.r.l.  
Via Goffredo Mameli 12 I-95020 Aci  
Bonaccorsi, Catania, Italy

(540)Madrid Application

**VIVIDRAW**

(511) 03  
(210) No. M/1685259  
(220) 30/08/2024  
(732) GOWOONSESANG COSMETICS CO., LTD.  
11F, 55, BUNDANG-RO, BUNDANG-GU,  
SEONGNAM-SI GYEONGGI-DO,  
REPUBLIC OF KOREA

(540)Madrid Application

**FERTIPLANT**

(511) 01

(210) No. M/1689728

(220) 31/07/2024

(732) PLANTIN

381 route d'Avignon, Usine la Rolande, BP2  
F-84350 COURTHEZON, France

(540)Madrid Application



(511) 07, 09, 12 and 37

(210) No. M/1713519

(220) 28/08/2024

(732) Caterpillar Inc.

100 N E Adams Street Peoria Illinois 61629,  
United States of America



(540)Madrid Application

**HEAL US**

(511) 03

(210) No. M/1715342

(220) 30/08/2024

(732) GWOONSESANG COSMETICS CO., LTD.

11F, 55, BUNDANG-RO, BUNDANG-GU,  
SEONGNAM-SI GYEONGGI-DO,  
REPUBLIC OF KOREA

(540)Madrid Application

**Milesight**

(511) 09

(210) No. M/1740148

(220) 11/06/2024

(732) Xiamen Milesight Iot Co., Ltd.

401, Building No.37, Xixishanwei Road,  
Software Park Phase III, Torch Development  
Zone for High Technology Industries, Jimei  
District, Xiamen Fujian, China

(540)Madrid Application

**BETFIRSO**

(511) 05

(210) No. M/1758004

(220) 23/08/2024

(732) Constellation Pharmaceuticals, Inc.

470 Atlantic Avenue, Suite 1401 Boston MA  
02210, United States of America

(540)Madrid Application



(511) 03

(210) No. M/1768456

(220) 15/08/2024

(732) Sterling Perfumes Industries LLC

Ras Al Khor Industrial Area, PO BOX 40769  
Dubai, United Arab Emirates

(540)Madrid Application

**ROX**

(511) 12

(210) No. M/1772993

(220) 13/09/2024

(732) Rox Motor Tech Co., Ltd.

1801, No.25, Lane 1688, Guoquan Road

(north) Yangpu District, Shanghai, China

(540)Madrid Application

**ZIK ZIK**

(511) 30

(210) No. M/1774069

(220) 02/07/2024

(732) ASIA FOOD TECHNOLOGY JOINT STOCK  
COMPANY (AFOTECH., JSC)

No.8, TS15 Road, Tien Son Industrial Zone,

Hoan Son Commune, Tien Du District Bac

Ninh Province, Vietnam

(540)Madrid Application

库员外  
**Kuyuanwai**

(511) 25

(210) No. M/1776704

(220) 13/09/2024

(732) Hangzhou Qunxiangyun Technology Co.,  
Ltd.

Room 305, 3F, Building No. 1, Qunjia  
Building, No. 366 Shengkang Street,  
Shangcheng District, Hangzhou 266005  
Zhejiang, China

(540)Madrid Application

**SEGWAY**

(511) 09 and 12

(210) No. M/1791143

(220) 04/07/2024

(732) Segway Inc.

14 Technology Drive Bedford NH 03110,  
United States of America

(540)Madrid Application



(511) 09 and 12

(210) No. M/1792479

(220) 04/07/2024

(732) Segway Inc.

14 Technology Drive Bedford NH 03110,  
United States of America

(540)Madrid Application



(511) 05

(210) No. M/1801565

(220) 03/09/2024

(732) hy Co., Ltd.

577, Gangnam-daero, Seocho-gu Seoul  
06530, Republic of Korea

(540)Madrid Application

**DANDY**

(511) 33

(210) No. M/1806214

(220) 12/07/2024

(732) Madame LUCCHINI Marine

18 rue de Condé F-69002 LYON, France

(540)Madrid Application

**FLAVIA**

(511) 03

(210) No. M/1806221

(220) 11/06/2024

(732) STERLING PERFUMES INDUSTRIES

(L.L.C.)

Factory No. 10/11, Owned By Dubai

Investment Park, PO Box 40769 Dubai,

United Arab Emirates

(540)Madrid Application

club de nuit

(511) 03

(210) No. M/1806222

(220) 11/06/2024

(732) STERLING PERFUMES INDUSTRIES

Factory No. 2, Owned By Fakhruddin

Ibrahim Al Hendi, Dubai Investment Park 2,

P O Box 40769 Dubai, United Arab Emirates

(540)Madrid Application

Jenny Glow

(511) 03

(210) No. M/1806230

(220) 11/06/2024

(732) STERLING PERFUMES INDUSTRIES

(L.L.C.)

Factory No. 10/11, Owned By Dubai

Investment Park, PO Box 40769 Dubai,

United Arab Emirates

(540)Madrid Application



(511) 07 and 09

(210) No. M/1806234

(220) 10/05/2024

(732) Chongqing Amity Machinery Co., Ltd.  
28-5#, No. 200 Zhongshan 2 Road, Yuzhong  
District 400014 Chongqing, China

(540)Madrid Application

**TTC AgriS**

(511) 30, 32 and 35

(210) No. M/1806238

(220) 20/07/2024

(732) AGRIS GLOBE PTE. LTD.  
60 PAYA LEBAR ROAD, #10-52 PAYA  
LEBAR SQUARE SINGAPORE 409051



(540)Madrid Application

**GENEA**

(511) 42 and 44

(210) No. M/1806245

(220) 08/07/2024

(732) Genea Pty Ltd

Level 2, 321 Kent Street Sydney NSW 2000,  
Australia

(540)Madrid Application

**POWER FLASH**

(511) 09

(210) No. M/1806258

(220) 11/06/2024

(732) Shandong Huatai New Energy Battery Co.,  
Ltd.

Changshen Line and industrial 1st road  
intersection, Tangtou Street, Hedong District,  
Linyi City 276000 Shandong Province, China

(540)Madrid Application

**BANK OF GUI LIN**

(511) 09, 35 and 36

(210) No. M/1806259

(220) 30/05/2024

(732) Bank of Guilin Limited

No.8, Park North Road, Lingui District,

Guilin City 541199 Guangxi Province, China

(540)Madrid Application

**ziaja**

(511) 03 and 05

(210) No. M/1806267

(220) 26/07/2023

(732) ZIAJA Ltd Zakład Produkcji Leków Spółka z

o.o.ul. Jesienna 9 PL-80-298 Gdańsk, Poland

(540)Madrid Application

**KSAS**

(511) 07, 09, 12, 35, 37, 39, 42 and 44

(210) No. M/1806327

(220) 16/04/2024

(732) KUBOTA CORPORATION

2-47, Shikitsuhigashi 1-chome, Naniwa-ku,  
Osaka-shi Osaka 556-8601, Japan

(540)Madrid Application

**genea**  
**WORLD LEADING  
FERTILITY**

(511) 42 and 44

(210) No. M/1806355

(220) 08/07/2024

(732) Genea Pty Ltd

Level 2, 321 Kent Street Sydney NSW 2000,  
Australia

(540)Madrid Application

**SPAULDING**

(511) 17

(210) No. M/1806385

(220) 29/04/2024

(732) SPAULDING COMPOSITES, INC.

55 Nadeau Drive Rochester NH 03867,  
United States of America

(540)Madrid Application

*Arilly*

(511) 03

(210) No. M/1806395

(220) 04/06/2024

(732) BLUE ORIGIN MANAGEMENT

CONSULTANT PTE. LTD.

73 UPPER PAYA LEBAR ROAD, #07-02J  
CENTRO BIANCO SINGAPORE 534818

(540)Madrid Application



(511) 03 and 05

(210) No. M/1806396

(220) 03/09/2024

(732) BLUE ORIGIN MANAGEMENT  
CONSULTANT PTE. LTD.

73 UPPER PAYA LEBAR ROAD, #07-02J  
CENTRO BIANCO SINGAPORE 534818

(540)Madrid Application



(511) 03 and 21

(210) No. M/1806397

(220) 04/06/2024

(732) BLUE ORIGIN MANAGEMENT  
CONSULTANT PTE. LTD.

73 UPPER PAYA LEBAR ROAD, #07-02J  
CENTRO BIANCO SINGAPORE 534818

(540)Madrid Application



EUROVISION  
UNITED BY MUSIC

(511) 03, 09, 14, 16, 18, 21, 25, 28, 29, 30, 32, 33, 35, 38, 39, 41, 42, 43 and 45

(210) No. M/1806449

(220) 06/03/2024

(732) Union Européenne de Radio-Télévision  
L'Ancienne-Route 17 A CH-1218  
Le Grand-Saconnex, Switzerland

(540)Madrid Application



(511) 11

(210) No. M/1806514

(220) 09/05/2024

(732) Guangzhou Yuandong Fan Co. Ltd. and  
Foshan Nanhai Yuanzuan Electric Appliance  
Co., Ltd.  
No 43, Huanghua Road, Yuexiu District,  
Guangzhou City Guangdong Province, China  
and North Dali Lizhongjiaoxin, Nanhai  
District, Foshan Guangdong, China

(540)Madrid Application

The logo for 'PICK CENTURY' features the word 'PICK' in a serif font above the word 'CENTURY' in a similar serif font. A decorative swirl or flourish is positioned behind the 'Y' in 'CENTURY'.

(511) 03

(210) No. M/1806521

(220) 04/06/2024

(732) BLUE ORIGIN MANAGEMENT  
CONSULTANT PTE. LTD.

73 UPPER PAYA LEBAR ROAD, #07-02J  
CENTRO BIANCO SINGAPORE 534818

(540)Madrid Application

The logo for 'SconAst' features the word 'Scon' in a bold, sans-serif font with a small star above the 'o', followed by 'Ast' in a similar bold, sans-serif font.

(511) 03 and 05

(210) No. M/1806572

(220) 18/06/2024

(732) BLUE ORIGIN MANAGEMENT  
CONSULTANT PTE. LTD.

73 UPPER PAYA LEBAR ROAD, #07-02J  
CENTRO BIANCO SINGAPORE 534818

(540)Madrid Application



(511) 25 and 28

(210) No. M/1806598

(220) 08/07/2024

(732) GOR FACTORY, S.A.

Ctra. de Santomera- Albanilla Km. 8,800,  
Nave 2 E-30620 Fortuna (Murcia), Spain

(540)Madrid Application



(511) 10

(210) No. M/1806624

(220) 24/05/2024

(732) Shanghai Personage Hygiene Products

Co.,Ltd

No. 88 Tianchen Road, Qingpu District  
Shanghai, China



(540)Madrid Application

**iLovbee**

(511) 09

(210) No. M/1806643

(220) 06/05/2024

(732) Guangdong Heyicai Investment Co., Ltd.  
398-8 Xingyuan Five Road, Yuanzhou Town,  
Boluo County, Huizhou City 516000  
Guangdong Province, China

(540)Madrid Application

**Ifan**

(511) 11, 17 and 19

(210) No. M/1806646

(220) 14/06/2024

(732) Zhejiang Yifan Piping Co., LTD.  
No. 3 Zhongyang Road, Diankou Town,  
Zhuji City, Shaoxing City Zhejiang Province,  
China

(540)Madrid Application



(511) 12

(210) No. M/1806656

(220) 20/06/2024

(732) Zhejiang Geely Farizon New Energy  
Commercial Vehicle Group Co., Ltd.  
Room 612, Building 1, No. 1760, Jiangling  
Road Binjiang District, Hangzhou City  
Zhejiang Province, China

(540)Madrid Application

(511) 28

(210) No. M/1806659

(220) 04/06/2024

(732) Shenzhen Blue Origin Brand Management  
Co., Ltd.  
Room 3302, Building 2, Shenzhen New  
Generation Industrial Park, No. 136,  
Zhongkang Road, Meidu Community, Meilin  
Street, Futian District, Shenzhen City  
Guangdong Province, China

(540)Madrid Application

Cheecase

(511) 18

(210) No. M/1806664

(220) 26/07/2024

(732) Jiaxing Bu Lai Mei Information Technology  
CO., LIMITED  
B1, Building 2, Jiabao Group Cultural  
Industrial Park, No. 362 Fuxing Road, Nanhu  
District, Jiaxing Zhejiang Province, China

(540)Madrid Application



(511) 09, 28, 41 and 42

(210) No. M/1806702

(220) 05/03/2024

(732) Euro Games Technology Ltd.  
"Maritsa" Str. 4, "Vranya-Lozen-Triugulnika"  
BG-1151 Sofia, Bulgaria

(540)Madrid Application

The logo consists of the word "GINT" in a bold, black, sans-serif font. The letter "I" is slightly taller than the other letters and has a small white diagonal stroke through its center.

(511) 21

(210) No. M/1806718

(220) 21/05/2024

(732) Zhejiang Gint Vacuum Flask Technology Co., Ltd.

No. 1389 Xinggang Road, Dushangang District, Pinghu City Jiaxing City 314200 Zhejiang, China

(540)Madrid Application

The logo features the number "555" in a bold, black, serif font, centered within an ornate, oval-shaped decorative frame with intricate scrollwork. Below the frame, the word "Masamori" is written in a bold, black, sans-serif font.

(511) 12

(210) No. M/1806720

(220) 22/05/2024

(732) Anhui Zhengsheng Machinery Manufacturing Co., Ltd.

Bicycle Industrial Park of No. 29 Xinghui Road, Chengnan Park, Chengguan Town, Wuhe County, Bengbu City Anhui Province, China

(540)Madrid Application

The logo for EON HOME features the word "EON" in a bold, sans-serif font, with a stylized circular icon containing a dot and a curved line to its left. The word "HOME" is in a similar bold, sans-serif font to the right of "EON".

(511) 20 and 24

(210) No. M/1806727

(220) 27/05/2024

(732) Guangdong EON Home Group Co., Ltd.

No.1, 12/F, Block A, Guangdong EONJOY  
Technology Limited, Yingmingchangda  
Industrial Zone, Shatou Area, Jiujiang Town,  
Nanhai District, Foshan City 528208  
Guangdong Province, China

(540)Madrid Application

The logo for dpolla features the word "dpolla" in a lowercase, rounded, sans-serif font.

(511) 03, 10 and 21

(210) No. M/1806731

(220) 21/06/2024

(732) ZHEJIANG ZOREYA COSMETIC Co., Ltd

127 Wenchuang Road, Huangzhai Town,  
Pujiang County Zhejiang Province, China

(540)Madrid Application

Ikarao

(511) 09 and 35

(210) No. M/1806735

(220) 26/07/2024

(732) Dongguan Aika Electronic Technology Co.,  
Ltd.

Room 201, Building 2, No.388, Bihu Avenue,  
Fenggang Town, Dongguan City Guangdong  
Province, China

(540)Madrid Application

yiikoo

(511) 09

(210) No. M/1806738

(220) 26/07/2024

(732) Shenzhen Xinruiming Technology Co., Ltd.

A2008, Block A, Longguang Jiuzuan  
Business Center (Tenglong Road, Daling  
Community), Minzhi Street, Longhua  
District, Shenzhen Guangdong Province,  
China

(540)Madrid Application

theioioio

(511) 25

(210) No. M/1806741

(220) 14/05/2024

(732) Cai Hao Yuan

3rd Floor, Jianhao Industrial Building,  
Xiaping Middle Road, Guicheng Street,  
Nanhai District, Foshan City Guangdong  
Province, China

(540)Madrid Application

MCHOSE

(511) 09

(210) No. M/1806745

(220) 11/05/2024

(732) Shenzhen Zhishi Intelligent Technology Co.,  
Ltd.

A3401 Rongde Times Square, Huaqiao New  
Village, Henggang Street, Longgang District,  
Shenzhen 518000 Guangdong, China

(540)Madrid Application

**IRUNSVAN**

(511) 25

(210) No. M/1806747

(220) 04/06/2024

(732) Putian Huiyue Sporting Goods Co., Ltd.

No. 299 Meixue West Road, Huangshi Town,  
Licheng District, Putian City Fujian Province,  
China

(540)Madrid Application

Mossécca

(511) 14 and 26

(210) No. M/1806750

(220) 04/06/2024

(732) Dongguan Blue Origin Brand Management  
Co., Ltd.

Room 1501, Yujing Building, No. 577  
Dongcheng Road, Dongcheng District,  
Dongguan Guangdong Province, China



(540)Madrid Application

**SOHN**

(511) 09

(210) No. M/1806751

(220) 04/06/2024

(732) SHANGHAI WEIHONGHANG CULTURE  
COMMUNICATION CO., LTD

(Shanghai Hengtai Jingji Kaifa Zone) No.58  
Fumin Branch Rd, Hengsha Township,  
Chongming, Shanghai 202150 China

(540)Madrid Application

**findense**

(511) 04

(210) No. M/1806752

(220) 03/06/2024

(732) Dongguan Blue Origin Brand Management  
Co., Ltd.

Room 1501, Yujing Building, No. 577  
Dongcheng Road, Dongcheng District,  
Dongguan Guangdong Province, China

(540)Madrid Application

**Beteronbeter**

(511) 25

(210) No. M/1806753

(220) 03/06/2024

(732) Dongguan Blue Origin Brand Management  
Co., Ltd.

Room 1501, Yujing Building, No. 577

Dongcheng Road, Dongcheng District,

Dongguan Guangdong Province, China

(540)Madrid Application

**KINGCELL**

(511) 09

(210) No. M/1806799

(220) 11/06/2024

(732) Shandong Huatai New Energy Battery Co.,  
Ltd.

Changshen Line and industrial 1st road

intersection, Tangtou Street, Hedong District,

Linyi City 276000 Shandong Province, China

(540)Madrid Application



(511) 03

(210) No. M/1806805

(220) 31/05/2024

(732) Guangzhou Borun Brand Marketing Co., Ltd.  
Room 1058, 1st Floor, No.43, Shiliuqiao  
Road, Sanyuanli Street, Baiyun District,  
Guangzhou City Guangdong Province, China

(540)Madrid Application

The image shows the Chinese characters '佳丰' (Jiā fēng) in a bold, black, sans-serif font. The characters are positioned on the left side of the page.

(511) 16

(210) No. M/1806809

(220) 04/06/2024

(732) SUZHOU JIAFENG PAPER CO.LTD  
West side of Building 2, No. 21 Xihenggang  
Street, Yangchenghu Town, Xiangcheng  
District, Suzhou City Jiangsu Province, China

(540)Madrid Application

河套王

(511) 33

(210) No. M/1806814

(220) 17/06/2024

(732) Inner Mongolia Hetao Liquor Co.,Ltd  
No.39 Jianshe Street, Shanba Town,  
Hangjinhouqi, Bayan Nur City 015499 Inner  
Mongolia Autonomous Region, China

(540)Madrid Application

源苏天创

(511) 06

(210) No. M/1806825

(220) 06/05/2024

(732) Suzhou Tianchuang Metal Products Co., Ltd.  
Xingsheng Road, Huangqiao Street Industrial  
Park, Xiangcheng District, Suzhou City  
215000 Jiangsu Province, China

(540)Madrid Application



**ADORABLE  
STOCAI**

(511) 25

(210) No. M/1806828

(220) 03/06/2024

(732) Dongguan Blue Origin Brand Management  
Co., Ltd.

Room 1501, Yujing Building, No. 577

Dongcheng Road, Dongcheng District,

Dongguan Guangdong Province, China

(540)Madrid Application



**zinetic**

(511) 28

(210) No. M/1806836

(220) 28/06/2024

(732) FUJIAN U.SUN TRADING CO.,LTD.

1701 ZHONGFU PLAZA NO.92 DONGJIE

RD, Gulou District, Fuzhou City Fujian

Province, China

(540)Madrid Application

**MÔND'SUB**

(511) 03

(210) No. M/1806839

(220) 30/07/2024

(732) GUANGZHOU XUJOHN BIO-  
TECHNIQUE CO., LTD

No.1 Building, 7th Yard, Lianda Road,  
Huangpu District, Guangzhou City  
Guangdong Province, China

(540)Madrid Application

**BAOLEELAI**

(511) 11

(210) No. M/1806861

(220) 20/06/2024

(732) Zhejiang Baolilai Sanitary Ware Technology  
Co., Ltd.

2 meters East, No. 14, West Hengtang, Sanjin  
Village, Jinqing Town, Luqiao District,  
Taizhou City 318058 Zhejiang Province,  
China

(540)Madrid Application

**VASAGLE**

(511) 11, 20 and 21

(210) No. M/1806863

(220) 03/06/2024

(732) Ziel Home Furnishing Technology Co., Ltd.  
Suite 601, 6F Dongfang Building, No. 198-19  
Songshan South Road, Erqi District,  
Zhengzhou City Henan Province, China

(540)Madrid Application

**Magic V Ultimate**

(511) 09

(210) No. M/1806866

(220) 26/06/2024

(732) Honor Device Co., Ltd.  
Suite 3401, Unit A, Building 6, Shum Yip  
Sky Park, No. 8089, Hongli West Road,  
Xiangmihu Street, Futian District Shenzhen  
518040 Guangdong, China

(540)Madrid Application



(511) 03, 05 and 16

(210) No. M/1806868

(220) 04/06/2024

(732) Shenzhen Blue Origin Brand Management Co., Ltd.

Room 3302, Building 2, Shenzhen New Generation Industrial Park, No. 136, Zhongkang Road, Meidu Community, Meilin Street, Futian District, Shenzhen City Guangdong Province, China

(540)Madrid Application



(511) 15

(210) No. M/1806872

(220) 03/04/2024

(732) Dongguan Yueshou Times Musical Instrument Co., LTD

4/F, No. 3, Chuangye Road, Oudeng Village, Gaobu Town, Dongguan 523000 Guangdong Province, China



(540)Madrid Application

The logo for STORO, featuring the word "STORO" in a bold, sans-serif font. The letters are black with a white outline, giving it a 3D or embossed appearance.

(511) 06

(210) No. M/1806879

(220) 25/06/2024

(732) SHENZHEN HOPO WINDOW CONTROL  
TECHNOLOGY CO., LTD

6th Floor, Area A, Building 1, No. 6, 2nd  
Xinggong Road, Hongxing Society, Yutang  
Jiedao, Guangming District Shenzhen,  
Guangdong, China

(540)Madrid Application

The logo for YEWYORK, featuring the word "YEWYORK" in a bold, sans-serif font. The letters are black with a white outline, giving it a 3D or embossed appearance.

(511) 12

(210) No. M/1806882

(220) 20/05/2024

(732) Shandong Youyue Rubber Technology Co.,  
Ltd.

No.1 Futian Road, Zhucheng City, Weifang  
City Shandong Province, China

(540)Madrid Application



SHENLONGJIA

(511) 22

(210) No. M/1806889

(220) 28/06/2024

(732) Suning County Zhongyuan Textile Co., Ltd  
Three kilometers south of Suning County,  
Cangzhou City Hebei province, China

(540)Madrid Application



**Burnet**  
reach for the many

(511) 36, 41, 42 and 44

(210) No. M/1806912

(220) 02/04/2024

(732) The Macfarlane Burnet Institute for Medical  
Research and Public Health Limited  
85 Commercial Rd Melbourne VIC 3004,  
Australia

(540)Madrid Application

**REACH FOR THE  
MANY**

(511) 36, 41, 42 and 44

(210) No. M/1806914

(220) 02/04/2024

(732) The Macfarlane Burnet Institute for Medical  
Research and Public Health Limited  
85 Commercial Rd Melbourne VIC 3004,  
Australia

(540)Madrid Application

**GEELY E5**

(511) 12

(210) No. M/1806953

(220) 06/02/2024

(732) ZHEJIANG GEELY HOLDING GROUP  
CO., LTD.  
1760 JIANGLING ROAD, BINJIANG  
DISTRICT, HANGZHOU ZHEJIANG,  
CHINA

(540)Madrid Application

The logo for 'REBORN' features the word in a bold, black, sans-serif font. A stylized black leaf is positioned above the letter 'O', with its stem extending to the right and ending in a small hook that underlines the 'N'.

(511) 23

(210) No. M/1806962

(220) 08/04/2024

(732) Jiangsu Guowang High-Technique Fiber Co.,  
Ltd.

Meiyan Development Area, Wujiang, Suzhou  
City 215000 Jiangsu Province, China

(540)Madrid Application



(511) 09, 41 and 42

(210) No. M/1806974

(220) 05/06/2024

(732) Stropus Ltd.

7-9 Riga Fereou, Lizantia Court, office 310,  
Agiou Omologites CY-1087 Nicosia, Cyprus

(540)Madrid Application



(511) 01 and 04

(210) No. M/1806979

(220) 11/06/2024

(732) VEEDOL INTERNATIONAL LIMITED

4th Floor, 115 George Street Edinburgh,  
Scotland EH2 4JN, United Kingdom

(540)Madrid Application



(511) 01 and 04

(210) No. M/1806980

(220) 11/06/2024

(732) VEEDOL INTERNATIONAL LIMITED

4th Floor, 115 George Street Edinburgh,  
Scotland EH2 4JN, United Kingdom

(540)Madrid Application

LUCKY NUMBER

(511) 09, 28, 41 and 42

(210) No. M/1807146

(220) 19/04/2024

(732) Interblock d.o.o.

6900 S Decatur Blvd, Suite 100 Las Vegas  
NV 89118, United States of America

(540)Madrid Application



(511) 03, 29, 30, 32 and 35

(210) No. M/1807249

(220) 03/07/2024

(732) JR LIFE SCIENCES PTE. LTD.

2 BUKIT BATOK STREET 24, #08-20  
SKYTECH SINGAPORE 659480

(540)Madrid Application



(511) 05

(210) No. M/1807250

(220) 02/07/2024

(732) JR LIFE SCIENCES PTE LTD

2 BUKIT BATOK STREET 24, #08-20

SKYTECH SINGAPORE 659480

(540)Madrid Application

**SUBLIMIC**

(511) 03, 09, 41 and 44

(210) No. M/1807347

(220) 26/07/2024

(732) SHISEIDO PROFESSIONAL INC.

5-5, Ginza 7 Cho-me, Chuo-ku Tokyo

104-0061, Japan

(540)Madrid Application

**SUBLIMIC**

(511) 01, 05, 08, 11, 18, 20, 21, 25, 35 and 42

(210) No. M/1807349

(220) 26/07/2024

(732) SHISEIDO PROFESSIONAL INC.

5-5, Ginza 7 Cho-me, Chuo-ku Tokyo

104-0061, Japan

(540)Madrid Application

**IOPE**

(511) 03

(210) No. M/1807368

(220) 25/06/2024

(732) Amorepacific Corporation

100, Hangang-daero, Yongsan-gu Seoul,

Republic of Korea



(540)Madrid Application



(511) 08 and 11

(210) No. M/1807377

(220) 29/05/2024

(732) Hoco technology development (Shenzhen)  
Co., LTD

Rm 408, 4th Floor, Block A, Weidonglong  
Business Building, No.2125, Meilong Road,  
Tsinghua Community, Longhua Street,  
Longhua District, Shenzhen 518048  
Guangdong Province, China

(540)Madrid Application



(511) 32

(210) No. M/1807379

(220) 12/06/2024

(732) HUANLEJIA FOOD GROUP CO., LTD.

28th, 29th, 31st, and 32nd Floors of Huanlejia  
Building, No. 71 Middle Renmin Avenue,  
Development Zone Zhanjiang City,  
Guangdong Province, China

(540)Madrid Application

**CHROMAGLOW**

(511) 09

(210) No. M/1807386

(220) 02/08/2024

(732) Apple Inc.

One Apple Park Way Cupertino CA 95014,  
United States of America

(540)Madrid Application



(511) 06 and 09

(210) No. M/1807482

(220) 03/04/2024

(732) ÜNTEL KABLOLARI SANAYİİ VE  
TİCARET ANONİM ŞİRKETİ  
DEMİRCİLER KÖYÜ, MAKİNA OSB 6.  
Cadde, 4 Dilovası Kocaeli, Turkey

(540)Madrid Application

**MELANCLAIR**

(511) 03 and 05

(210) No. M/1807507

(220) 04/07/2024

(732) REVALENE LABS

32 Rue Louis Pasteur F-92100

Boulogne-Billancourt, France

(540)Madrid Application

**VITALBEAUTIE**

(511) 29

(210) No. M/1807541

(220) 13/06/2024

(732) Amorepacific Corporation

100, Hangang-daero, Yongsan-gu Seoul,

Republic of Korea

(540)Madrid Application

**IFIT**

(511) 38

(210) No. M/1807557

(220) 30/05/2024

(732) IFIT INC.

1500 SOUTH 1000 WEST LOGAN UT 84321,  
UNITED STATES OF AMERICA

(540)Madrid Application



(511) 30, 32, 35 and 43

(210) No. M/1807577

(220) 12/06/2024

(732) CHAGEE INVESTMENT PTE. LTD.

987 SERANGOON ROAD SINGAPORE

(540)Madrid Application

**Burning Goals**

(511) 09, 28, 41 and 42

(210) No. M/1807608

(220) 05/02/2024

(732) Euro Games Technology Ltd.

"Maritsa" Str. 4, "Vranya-Lozen-Triugulnika"

BG-1151 Sofia, Bulgaria

(540)Madrid Application

**SPACEMAN**

(511) 11

(210) No. M/1807627

(220) 04/06/2024

(732) Lingyu Dong

6059 Camellia Ave Temple City CA 91780,

United States of America

(540)Madrid Application



(511) 09, 28, 41 and 42

(210) No. M/1807722

(220) 03/04/2024

(732) EGT DIGITAL LTD.

"Panorama Sofia" Str. 6, Business Center

"Richhill", block A BG-1766 Sofia, Bulgaria

(540)Madrid Application

The logo features the word 'Hien' in a bold, black, sans-serif font. To its right are the Chinese characters '生能' in a bold, black, sans-serif font.

(511) 11

(210) No. M/1807841

(220) 09/04/2024

(732) Zhejiang AMA & HIEN Technology Co., Ltd

Charasteristic Industrial Zone, Puqi Town,

Yueqing City Zhejiang Province, China

(540)Madrid Application

**ROLEX**

(511) 03, 04, 08, 09, 11, 16, 18, 20, 21, 22, 24, 25,  
26, 27, 28, 30, 34 and 35

(210) No. M/1807916

(220) 13/05/2024

(732) ROLEX PROMOTIONS SA

5 rue François-Dussaud CH-1211 Genève 26,  
Switzerland

(540)Madrid Application



(511) 03, 04, 08, 09, 11, 16, 18, 20, 21, 22, 24, 25,  
26, 27, 28, 30, 34 and 35

(210) No. M/1807920

(220) 13/05/2024

(732) ROLEX PROMOTIONS SA

5 rue François-Dussaud CH-1211 Genève 26,  
Switzerland

(540)Madrid Application



(511) 09, 35, 36, 41 and 42

(210) No. M/1807998

(220) 05/06/2024

(732) ADVANCED NOVA TECHNOLOGIES  
(SINGAPORE) HOLDING PTE. LTD.  
128 BEACH ROAD, #20-01 GUOCO  
MIDTOWN OFFICE SINGAPORE 189773

(540)Madrid Application

**LIVDELZI**

(511) 05

(210) No. M/1808002

(220) 23/04/2024

(732) CymaBay Therapeutics, Inc.  
7575 Gateway Boulevard, Suite 110 Newark  
CA 94560, United States of America



(540)Madrid Application



(511) 09, 35, 38, 41 and 42

(210) No. M/1808046

(220) 27/02/2024

(732) AIRTEL DIGITAL LIMITED

Airtel Centre, Plot No. 16, Udyog Vihar,  
Phase-IV, Gurgaon Haryana 122015, India

(540)Madrid Application

**GARNIER GREEN  
ACIDS**

(511) 03

(210) No. M/1808237

(220) 22/07/2024

(732) L'OREAL

14 Rue Royale F-75008 Paris, France

(540)Madrid Application

**BUZCHAT**

(511) 09

(210) No. M/1808433

(220) 03/07/2024

(732) Nashor Pte. Ltd.

60 Anson Road, #09-01/02 Mapletree Anson  
Singapore 079914

(540)Madrid Application

**PremiAL**

(511) 06, 12, 19, 37 and 42

(210) No. M/1808468

(220) 21/03/2024

(732) LIXIL Corporation

Osaki Garden Tower, 1-1-1 Nishishinagawa,  
Shinagawa-ku Tokyo 141-0033, Japan

(540)Madrid Application



(511) 07

(210) No. M/1808599

(220) 18/06/2024

(732) ZHEJIANG PROWELL ELECTRONIC  
AND TECHNICAL CO., LTD.

(Inside Wuyi Tianrun Printing Co., LTD.),  
Shiligang, Huanglong Industrial Zone, Wuyi  
County, Jinhua City Zhejiang Province, China

(540)Madrid Application

**Yinwang**

(511) 07, 09, 11, 12, 37, 39 and 42

(210) No. M/1808601

(220) 28/05/2024

(732) Huawei Technologies Co., Ltd.

Administration Building Huawei Technologies  
Co.,Ltd. Bantian, Longgang District 518129  
Shenzhen, China

(540)Madrid Application



(511) 29

(210) No. M/1808603

(220) 04/07/2024

(732) Fujian Clever Mama Food Co., Ltd.

Jinglin Village Industrial Area, Dongshi

Town, Jinjiang City, Quanzhou City 362000

Fujian Province, China

(540)Madrid Application

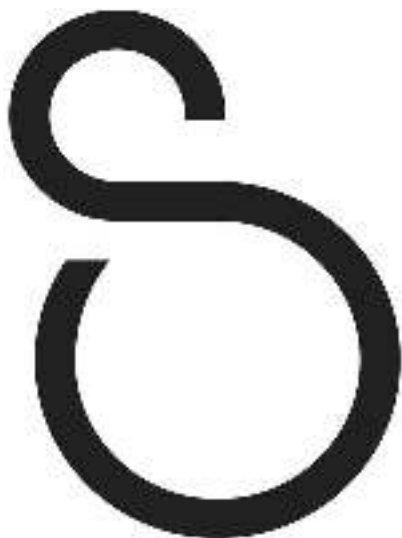

(511) 03, 05, 09, 10, 11, 35, 41, 42 and 44

(210) No. M/1808704

(220) 16/11/2023

(732) 3M Healthcare Intellectual Properties

Company

2501 Hudson Road, 3M Center St Paul MN

55144, United States of America

(540)Madrid Application

**TOUREL**

(511) 03

(210) No. M/1809197

(220) 29/05/2024

(732) LMZ (Jiangsu) Industrial Co., Ltd  
Hangji Industrial Park, Yangzhou City  
225000 Jiangsu Province, China

(540)Madrid Application



(511) 29, 35 and 43

(210) No. M/1809199

(220) 20/05/2024

(732) Guangdong Baheli Holding Co., Ltd.  
25A, 25/F Jinrun Building, No. 6019 Shennan  
Avenue, Tian'an Community, Shatou Street,  
Futian District, Shenzhen City Guangdong  
Province, China

(540)Madrid Application

**TNHCHOP**

(511) 09

(210) No. M/1809204

(220) 18/06/2024

(732) Shenzhen Tinno Mobile Technology Corp.  
27-001, South Side of Tinno Mobile  
Building, Tongfa South Road, Xili  
Community, Xili Street, Nanshan District,  
Shenzhen Guangdong, China

(540)Madrid Application

**Fixera**

(511) 05 and 25

(210) No. M/1809208

(220) 04/06/2024

(732) Shenzhen Blue Origin Brand Management  
Co., Ltd.  
Room 3302, Building 2, Shenzhen New  
Generation Industrial Park, No. 136,  
Zhongkang Road, Meidu Community, Meilin  
Street, Futian District, Shenzhen City  
Guangdong Province, China

(540)Madrid Application

**Mostórhata**

(511) 25

(210) No. M/1809210

(220) 04/06/2024

(732) Dongguan Blue Origin Brand Management  
Co., Ltd.

Room 1501, Yujing Building, No. 577

Dongcheng Road, Dongcheng District,

Dongguan Guangdong Province, China

(540)Madrid Application

**博雷顿**

(511) 04, 07 and 12

(210) No. M/1809223

(220) 07/06/2024

(732) Breton Technology Co.,Ltd

Room 208, 2nd Floor, Building 3, No. 168,

Shennan Road, Minhang District 201108

Shanghai, China

(540)Madrid Application



(511) 11 and 19

(210) No. M/1809237

(220) 06/06/2024

(732) SEAGULL CHAMPION CO., LTD

2802-2810, Golden Eagle Building, No. 199,  
Zhujiang Middle Road, Economic &  
Technical Development Zone, Kunshan City  
215300 Jiangsu Province, China

(540)Madrid Application

The logo consists of the Chinese characters "经纬汇" (Jingwei Hui) in a bold, sans-serif font.

(511) 23

(210) No. M/1809239

(220) 02/07/2024

(732) Chongqing Xinhua Industrial Co., Ltd.

002-05/02, opposite the sewage treatment  
plant in the county town cluster of Dianjiang  
Industrial Park Chongqing, China



(540)Madrid Application

**nomie nomie**

(511) 18

(210) No. M/1809247

(220) 07/08/2024

(732) Dongguan Blue Origin Brand Management  
Co., Ltd.

Room 1501, Yujing Building, No. 577  
Dongcheng Road, Dongcheng District,  
Dongguan Guangdong Province, China

(540)Madrid Application



(511) 40

(210) No. M/1809250

(220) 07/08/2024

(732) Quanzhou Baijia Printing Co.,Ltd

No.1158, Group 5, Lichun Village, Baiqi  
Township, Quanzhou Taiwanese Investment  
Zone, Quanzhou City 362000 Fujian  
Province, China

(540)Madrid Application

**GENKIKUN**  
HAPPY GO DUCKY

(511) 05

(210) No. M/1809257

(220) 31/10/2023

(732) QUANZHOU ENERGY BABYCARE CO.,  
LTD

Third floor, Weilida Office Building, Yangdai  
Village, Chendai Town, Jinjiang City,  
Quanzhou City 362000 Fujian Province,  
China

(540)Madrid Application

**feandrea**

(511) 18, 20 and 21

(210) No. M/1809278

(220) 11/06/2024

(732) Ziel Home Furnishing Technology Co., Ltd.

Suite 601, 6F Dongfang Building, No. 198-19  
Songshan South Road, Erqi District,  
Zhengzhou City Henan Province, China

(540)Madrid Application

**TOUREL**

(511) 21

(210) No. M/1809281

(220) 29/05/2024

(732) LMZ (Jiangsu) Industrial Co.,Ltd

Hangji Industrial Park, Yangzhou City

225000 Jiangsu Province, China

(540)Madrid Application

**Gregeo**

(511) 01 and 17

(210) No. M/1809282

(220) 18/06/2024

(732) Shandong Ruian Biotechnology Co., Ltd.

New Material Park, Huji Town, Jinxiang

County, Jining City Shandong Province,

China

(540)Madrid Application

志材辉科

(511) 06

(210) No. M/1809284

(220) 26/07/2024

(732) Taizhou Zhihui New Material Technology  
Co., Ltd.

Room 211 and 212, Building B, Block 18,  
Block Street Co construction Zone, No. 66  
Meilan East Road, Hailing Industrial Park,  
Hailing District, Taizhou City Jiangsu  
Province, China

(540)Madrid Application

睿安科技

(511) 01 and 17

(210) No. M/1809293

(220) 18/06/2024

(732) Shandong Ruian Biotechnology Co., Ltd.  
New Material Park, Huji Town, Jinxiang  
County, Jining City Shandong Province,  
China

(540)Madrid Application



(511) 04

(210) No. M/1809297

(220) 04/06/2024

(732) Shenzhen Blue Origin Brand Management Co., Ltd.

Room 3302, Building 2, Shenzhen New Generation Industrial Park, No. 136, Zhongkang Road, Meidu Community, Meilin Street, Futian District, Shenzhen City Guangdong Province, China

(540)Madrid Application

**Egradable**

(511) 18 and 25

(210) No. M/1809299

(220) 04/06/2024

(732) Dongguan Blue Origin Brand Management Co., Ltd.

Room 1501, Yujing Building, No. 577 Dongcheng Road, Dongcheng District, Dongguan Guangdong Province, China

(540)Madrid Application



(511) 06, 09, 12, 16, 35, 36, 39, 41, 42 and 45

(210) No. M/1809303

(220) 20/06/2024

(732) CHINA STATE RAILWAY GROUP CO.,  
LTD.

10, Fuxing Road, Haidian District Beijing,  
China

(540)Madrid Application

**PINGPOP**

(511) 24

(210) No. M/1809305

(220) 04/06/2024

(732) Shenzhen Blue Origin Brand Management  
Co., Ltd.

Room 3302, Building 2, Shenzhen New  
Generation Industrial Park, No. 136,  
Zhongkang Road, Meidu Community, Meilin  
Street, Futian District, Shenzhen City  
Guangdong Province, China

(540)Madrid Application

ÊTRE ÉMU

(511) 09

(210) No. M/1809306

(220) 04/06/2024

(732) Dongguan Blue Origin Brand Management  
Co., Ltd.

Room 1501, Yujing Building, No. 577

Dongcheng Road, Dongcheng District,

Dongguan Guangdong Province, China

(540)Madrid Application

Focus Plus

(511) 03

(210) No. M/1809308

(220) 03/06/2024

(732) Shanghai Yu Peng Gong Da Biotechnology  
Co., Ltd

Suite 108, 1 Floor Building 24, No. 1188

Huyi Road, Jiading District Shanghai, China

(540)Madrid Application



(511) 16

(210) No. M/1809317

(220) 19/06/2024

(732) Yiwu Lewang Stationery Co., Ltd.

No. 191, Chengdian Road, Choujiang Street,  
Yiwu City, Jinhua City 322000 Zhejiang  
Province, China

(540)Madrid Application



(511) 07 and 09

(210) No. M/1809320

(220) 28/06/2024

(732) Han, Xiang

Room 1201, No.5, Fuchang Road, Haizhu  
District, Guangzhou 510000 Guangdong,  
China



(540)Madrid Application

**SONGMICS**

(511) 14, 20 and 21

(210) No. M/1809324

(220) 04/06/2024

(732) Ziel Home Furnishing Technology Co., Ltd.  
Suite 601, 6F Dongfang Building, No. 198-19  
Songshan South Road, Erqi District,  
Zhengzhou City Henan Province, China

(540)Madrid Application

**MIEMIELand**

(511) 09, 14 and 26

(210) No. M/1809326

(220) 04/06/2024

(732) Dongguan Blue Origin Brand Management  
Co., Ltd.  
Room 1501, Yujing Building, No. 577  
Dongcheng Road, Dongcheng District,  
Dongguan Guangdong Province, China

(540)Madrid Application



(511) 04, 07 and 12

(210) No. M/1809329

(220) 07/06/2024

(732) Breton Technology Co.,Ltd

Room 208, 2nd Floor, Building 3, No. 168,  
Shennan Road, Minhang District 201108  
Shanghai, China

(540)Madrid Application

Beaganyc.

(511) 20

(210) No. M/1809334

(220) 04/06/2024

(732) Dongguan Blue Origin Brand Management  
Co., Ltd.

Room 1501, Yujing Building, No. 577  
Dongcheng Road, Dongcheng District,  
Dongguan Guangdong Province, China

(540)Madrid Application



(511) 11

(210) No. M/1809353

(220) 12/06/2024

(732) ZHEJIANG AOFENG ELECTRICAL  
APPLIANCES CO.,LTD  
NO.19, SHENBAO ROAD, BAIYANG  
STREET, WUYI COUNTY, JINHUA CITY  
ZHEJIANG PROVINCE, CHINA

(540)Madrid Application



(511) 18 and 25

(210) No. M/1809355

(220) 02/07/2024

(732) WENZHOU LIXINLONG IMP AND EXP  
CO., LTD.  
2/F Section 2 No. 2 Jinda Road, Xinqiao,  
Ouhai, Wenzhou 325000 Zhejiang, China

(540)Madrid Application



(511) 29 and 32

(210) No. M/1809361

(220) 08/07/2024

(732) HUANLEJIA FOOD GROUP CO., LTD.

28th, 29th, 31st, and 32nd Floors of Huanlejia  
Building, No. 71 Middle Renmin Avenue,  
Development Zone Zhanjiang City,  
Guangdong Province, China

(540)Madrid Application



(511) 05, 16, 18, 20, 21, 28 and 31

(210) No. M/1809369

(220) 07/08/2024

(732) Dongguan Blue Origin Brand Management  
Co., Ltd.

Room 1501, Yujing Building, No. 577  
Dongcheng Road, Dongcheng District,  
Dongguan Guangdong Province, China

(540)Madrid Application



(511) 17

(210) No. M/1809370

(220) 18/06/2024

(732) Zhejiang Wanma Co., Ltd.

No. 896 Heting Street, Qingshanhu Street,  
Lin'an District, Hangzhou City 310052  
Zhejiang Province, China

(540)Madrid Application

**Airqmics**

(511) 08 and 21

(210) No. M/1809371

(220) 07/08/2024

(732) Dongguan Blue Origin Brand Management  
Co., Ltd.

Room 1501, Yujing Building, No. 577  
Dongcheng Road, Dongcheng District,  
Dongguan Guangdong Province, China

(540)Madrid Application

**BEAUTY STORY**

(511) 03

(210) No. M/1809373

(220) 24/06/2024

(732) Zhejiang Meimi Technology Co., Ltd.  
No. 86 Xiangyi Road, Yiting Town,  
Yiwu Zhejiang, China

(540)Madrid Application

**QueenMaa**

(511) 03

(210) No. M/1809385

(220) 07/08/2024

(732) Dongguan Blue Origin Brand Management  
Co., Ltd.  
Room 1501, Yujing Building, No. 577  
Dongcheng Road, Dongcheng District,  
Dongguan Guangdong Province, China

(540)Madrid Application

The logo for ZELDA, featuring the word "ZELDA" in a bold, italicized, sans-serif font.

(511) 12

(210) No. M/1809396

(220) 26/07/2024

(732) Shandong Yousheng Tyre Co., Ltd.

Northeast Corner of the Intersection of Bohai Avenue and Yanglin Road, Yangkou Town, Shouguang City Shandong Province, China

(540)Madrid Application



(511) 25

(210) No. M/1809405

(220) 30/07/2024

(732) Jiangxi Difeno Shoes Co., Ltd.

Chengnan Industrial Zone, Jishui County, Ji'an City Jiangxi Province, China

(540)Madrid Application

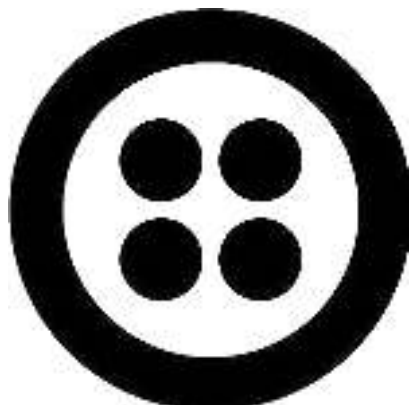

(511) 09, 35, 38 and 42

(210) No. M/1809479

(220) 07/06/2024

(732) Twilio Inc.

101 Spear St., Ste. 500 San Francisco CA  
94105, United States of America

(540)Madrid Application



(511) 09

(210) No. M/1809527

(220) 20/05/2024

(732) Shenzhen Far Ahead Electronic Industry Co.,  
Ltd

203, Building A, No. 5, Qiushuiling Industrial  
Zone, Egongling Community, Pinghu Street,  
Longgang District, Shenzhen City 100043  
Guangdong Province, China



(540)Madrid Application

**HONSWAY**

(511) 12

(210) No. M/1809528

(220) 28/05/2024

(732) Jiangsu Sanyuan Tire Co., Ltd

No. 99 Jialingjiang Road, Suyu Economic  
Development Zone, Suqian City 223800  
Jiangsu Province, China

(540)Madrid Application

**SIINSIIN**

(511) 25

(210) No. M/1809534

(220) 29/06/2024

(732) Hangzhou Xingyi Technology Co., Ltd.

Room 1301-5, Yinfeng Building, No. 1505  
Binsheng Road, Xixing Street, Binjiang  
District, Hangzhou City 310052 Zhejiang,  
China

(540)Madrid Application

The logo for RIDERPLUS, featuring the word "RIDERPLUS" in a bold, italicized, sans-serif font. The letters are black with a white outline, and the "R" and "P" are particularly prominent.

(511) 12

(210) No. M/1809538

(220) 14/06/2024

(732) Shenzhen AD Novo Technology Co., Ltd.

Room B02-2, 2nd Floor, Semi- Underground  
001, Guanlong Mingyuan, No.6 Tongfa Road,  
Xinwei Community, Xili Street, Nanshan  
District, Shenzhen City Guangdong Province,  
China

(540)Madrid Application

The logo for Guming Technology Group Co., Ltd., consisting of the Chinese characters "古茗" (Gǔ Míng) in a bold, black, sans-serif font.

(511) 16, 29, 30, 32, 35 and 43

(210) No. M/1809540

(220) 19/06/2024

(732) Guming Technology Group Co., Ltd.

The north side of class I highway at Daxi  
Town, Wenling City, Taizhou City 317525  
Zhejiang Province, China

(540)Madrid Application

The logo for SOLELY features the word "SOLELY" in a bold, sans-serif font. The letter "O" is replaced by a solid dark grey circle.

(511) 21

(210) No. M/1809543

(220) 03/06/2024

(732) Taizhou Solely Daily Necessities Co., Ltd.  
Building 1, No.1398 Haichang Road,  
Taizhou Zhejiang, China

(540)Madrid Application

The logo for LEXGO features the word "LEXGO" in a bold, sans-serif font. The letter "X" is stylized with a diagonal slash through it.

(511) 12

(210) No. M/1809545

(220) 25/06/2024

(732) Yueyang Aidaxing Intelligent Technology  
Co., LTD  
Floor 2, Building 7, Modern Industrial Park,  
Muligang Avenue, Yueyang Economic and  
Technological Development Zone, Yueyang  
City 414022 Hunan Province, China

(540)Madrid Application

**FOR THE STAY**

(511) 43

(210) No. M/1809547

(220) 16/07/2024

(732) Hilton Worldwide Manage Limited

Maple Court Central Park, Reeds Crescent

Watford, Hertfordshire WD24 4QQ,

United Kingdom

(540)Madrid Application

**Micun bibimbap**

(511) 43

(210) No. M/1809566

(220) 02/08/2024

(732) Zhou Dengqiang

Group 9, Changhong Committee, Jiangong

Street, Yanji City 130000 Jilin Province, China

(540)Madrid Application

The logo for TIANLI, featuring a stylized 'T' inside a circle followed by the word 'TIANLI' in a bold, italicized sans-serif font.

(511) 12

(210) No. M/1809586

(220) 05/07/2024

(732) Zhongce Rubber (Tianjin) Co., Ltd.

No. 347 Hanjiang Road, Lingang Economic  
Zone, Binhai New District Tianjin, China

(540)Madrid Application

The logo for PPW, consisting of the letters 'PPW' in a bold, italicized sans-serif font.

(511) 01 and 11

(210) No. M/1809587

(220) 09/07/2024

(732) FANSKI GROUP INC.

No. 7 Shengyuan Road, Yucheng Street,  
Yuhuan City Zhejiang Province, China

(540)Madrid Application

**CLEARNORTH**

(511) 03, 05, 09, 10, 11, 35, 41, 42 and 44

(210) No. M/1809743

(220) 18/08/2023

(732) 3M Healthcare Intellectual Properties

Company

2501 Hudson Road, 3M Center St Paul MN

55144, United States of America

(540)Madrid Application



(511) 11

(210) No. M/1809774

(220) 27/02/2024

(732) Zhejiang Jinling Electric Appliance Co., Ltd.

(2F, Building 2, Yijia Gift Co., Ltd.), No. 6,

Beiyang 7th Road, Toumengang New Area,

Linhai City, Taizhou City Zhejiang Province,

China

(540)Madrid Application

The logo for OSLIKA features the word "OSLIKA" in a bold, black, sans-serif font. The letters are closely spaced, and the "O" and "S" are particularly prominent.

(511) 07, 08, 09 and 11

(210) No. M/1809845

(220) 30/05/2024

(732) IMAX POWERTOOL COMPANY  
LIMITED

348 Theotthai Road, Bangkhae Sub-District,  
Bangkhae District 10160 Bangkok, Thailand

(540)Madrid Application

The logo consists of two parts: "KWADRON" and "INX". "KWADRON" is written vertically in a bold, black, sans-serif font within a rectangular border. "INX" is written horizontally to the right of "KWADRON" in a bold, black, sans-serif font.

(511) 02 and 08

(210) No. M/1809861

(220) 27/06/2024

(732) KWADRON SPÓŁKA Z OGRANICZONĄ  
ODPOWIEDZIALNOŚCIĄ SPÓŁKA  
KOMANDYTOWA

UL. SOSNOWIECKA 81 PL-31-345  
KRAKÓW, POLAND

(540)Madrid Application

**AGATHA**

(511) 14 and 26

(210) No. M/1809950

(220) 31/07/2024

(732) AGATHA

37 rue de Liège F-75008 Paris, France

(540)Madrid Application



(511) 35 and 38

(210) No. M/1809955

(220) 04/09/2024

(732) EMIRATES TELECOMMUNICATIONS

GROUP COMPANY (ETISALAT GROUP)

P.J.S.C.

Intersection of Sheikh Zayed II Street and  
Sheikh Rashid Bin Saeed Al Maktoum Street,  
P.O. Box 3838 Abu Dhabi,  
United Arab Emirates



(540)Madrid Application

Vertix

(511) 03

(210) No. M/1810098

(220) 08/02/2024

(732) JETHARAM NEMARAM GEHLOT

101, Shree White Heights Apartment,  
Saraswati Nagar, Hirawadi Road, Panchavati,  
Nashik 422003 Maharashtra, India

(540)Madrid Application

EMPEROR'S PALACE

(511) 09, 28 and 41

(210) No. M/1810562

(220) 15/04/2024

(732) Euro Games Technology Ltd.

6 Panorama Sofia Str., Richhill Business  
Center, ground floor, Vitosha region  
BG-1766 Sofia, Bulgaria

(540)Madrid Application



(511) 03, 04, 07, 08 and 09

(210) No. M/1810572

(220) 03/06/2024

(732) NORITAKE CO., LIMITED

1-36, Noritake-Shinmachi 3-chome, Nishi-ku,  
Nagoya-shi Aichi 451-8501, Japan

(540)Madrid Application



(511) 05

(210) No. M/1810601

(220) 12/07/2024

(732) Société des Produits Nestlé S.A.

CH-1800 Vevey, Switzerland

(540)Madrid Application

Infitek

(511) 07, 09, 10, 11 and 35

(210) No. M/1810625

(220) 08/08/2024

(732) Infitek Bioindustry Co., Ltd.

Rm. 2014-2, Bldg. 3, LigaoguojiHuayuan, No.  
1222, West Aoti Road, Lixia District,  
Jinan Shandong, China

(540)Madrid Application

OTRSTAR

(511) 12

(210) No. M/1810637

(220) 10/04/2024

(732) Shandong Zaozhuang Mining Group

Zhongxing Huitong Tyre Co., Ltd.  
No.11 Huitong East Road, Lai Cheng  
Industrial Zone, Laiwu District, Jinan City  
Shandong Province, China

(540)Madrid Application



(511) 29, 30 and 32

(210) No. M/1810743

(220) 25/07/2024

(732) Siam Dessert Co., Ltd.

6/1 Village No. 8, Sa Katiam Subdistrict,  
Mueang Nakhon Pathom District 73000  
Nakhon Pathom Province, Thailand

(540)Madrid Application

**GENMOJI**

(511) 09

(210) No. M/1810886

(220) 02/07/2024

(732) Apple Inc.

One Apple Park Way Cupertino CA 95014,  
United States of America

(540)Madrid Application

The logo consists of the word "SKYWORTH" in a bold, sans-serif font, followed by a large, stylized letter "K" that is also in a bold, sans-serif font.

(511) 12

(210) No. M/1810935

(220) 15/05/2024

(732) Skywell New Energy Vehicles Group Co.,  
Ltd.

No. 369 Binhuai Road, Lishui District,  
Nanjing Jiangsu, China

(540)Madrid Application

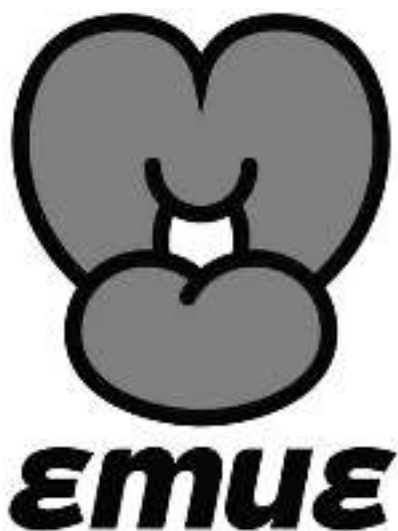
The logo features a stylized, grey, heart-shaped graphic with a white outline, resembling a flower or a stylized letter 'E'. Below the graphic, the word "EMUE" is written in a bold, black, sans-serif font.

(511) 28

(210) No. M/1811034

(220) 17/04/2024

(732) Shantou Liangao Toy Industry Co. LTD

Rongnan Road, Toufen village, Fengxiang  
Street, Chenghai, Shantou Guangdong, China

(540)Madrid Application

The logo consists of the word "KIA" in a bold, sans-serif font, followed by "PV7" in a larger, stylized font where the letters are interconnected.

(511) 12

(210) No. M/1811040

(220) 08/07/2024

(732) Kia Corporation

12, Heolleung-ro, Seocho-gu Seoul 06797,  
Republic of Korea

(540)Madrid Application

The logo consists of the word "KIA" in a bold, sans-serif font, followed by "PV1" in a larger, stylized font where the letters are interconnected.

(511) 12

(210) No. M/1811042

(220) 08/07/2024

(732) Kia Corporation

12, Heolleung-ro, Seocho-gu Seoul 06797,  
Republic of Korea

(540)Madrid Application

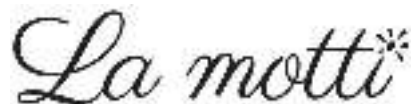
The logo for 'La motti' is written in a cursive, handwritten-style font. The word 'La' is in a smaller size than 'motti', and there is a small asterisk-like symbol at the end of the word.

(511) 03, 08 and 21

(210) No. M/1811054

(220) 07/08/2024

(732) Dongguan Blue Origin Brand Management  
Co., Ltd.

Room 1501, Yujing Building, No. 577

Dongcheng Road, Dongcheng District,

Dongguan Guangdong Province, China

(540)Madrid Application



(511) 21

(210) No. M/1811056

(220) 25/06/2024

(732) Ding Weizhong

No.50, Group 4, Yulong Village, Yihe Town,

Kai County Chongqing, China

(540)Madrid Application

The logo for KNAUF, featuring the word "KNAUF" in a bold, blue, sans-serif font. The letters are slightly slanted to the right.

(511) 01, 02, 06, 07, 08, 09, 11, 16, 17, 19, 20, 27,  
37, 41, 42 and 45

(210) No. M/1811118

(220) 03/06/2024

(732) Knauf Gips KG

Am Bahnhof 7 97346 Iphofen, Germany

(540)Madrid Application

The logo for FREY, featuring the word "FREY" in a bold, black, sans-serif font. The letters are set within a stylized, metallic-looking circular emblem with a horizontal bar across the middle.

(511) 07, 12 and 17

(210) No. M/1811149

(220) 16/05/2024

(732) ZHU XIAOZHONG

No. 86 Xinghu Road, Toutunhe District,  
Urumqi Economic and Technological  
Development Zone Xinjiang Uygur  
Autonomous Region, China



(540)Madrid Application

The logo for Bsonyo, featuring the word "Bsonyo" in a bold, black, sans-serif font. The letter "B" is stylized with three vertical bars to its left.

(511) 07

(210) No. M/1811150

(220) 17/06/2024

(732) Sonyo Compressor (Dalian) Co., Ltd.  
No.8#, Songlan Street, Economical &  
Technical Development Zone,  
Dalian Liaoning, China

(540)Madrid Application

The logo for Bank of Guilin Limited, featuring the Chinese characters "漓江" (Lijiang) in a bold, black, sans-serif font.

(511) 09, 35 and 36

(210) No. M/1811159

(220) 26/07/2024

(732) Bank of Guilin Limited  
No. 8, Park North Road, Lingui District,  
Guilin City 541199 Guangxi Province, China

(540)Madrid Application



(511) 21, 30 and 43

(210) No. M/1811170

(220) 29/05/2024

(732) BEIJING XIAOGUAN TEA CO., LTD.

Room 206-41, Floor 2, Building 1, Yard 1,  
Gongyuan Street, Tongzhou District Beijing,  
China

(540)Madrid Application



(511) 04, 09 and 39

(210) No. M/1811184

(220) 10/07/2024

(732) China Southern Power Grid Company

Limited  
No. 11 Kexiang Road, Science Park, Luogang  
District, Guangzhou Guangdong, China

(540)Madrid Application



(511) 03

(210) No. M/1811192

(220) 07/08/2024

(732) Gong Liping

No.8, Lane 3, West Street, South Gate,

Zhakuqi Niulu Township, Qapqal Xibe

Autonomous County, Xinjiang 835312 Uygur

Autonomous Region, China

(540)Madrid Application

**Xinghe**

(511) 09 and 42

(210) No. M/1811194

(220) 11/07/2024

(732) Huawei Technologies Co., Ltd.

Administration Building, Huawei Technologies

Co., Ltd., Bantian, Longgang District 518129

Shenzhen, China

(540)Madrid Application



(511) 03, 07, 16, 24 and 27

(210) No. M/1811198

(220) 18/06/2024

(732) Yiwu Power Tiger Auto Accessory Co., Ltd.

Building 4, Area A, No. E22, Xinke Road,  
Economic Development Zone, Choujiang  
Street, Yiwu City, Jinhua City 321000  
Zhejiang Province, China

(540)Madrid Application



(511) 07, 08, 09 and 21

(210) No. M/1811268

(220) 12/06/2024

(732) ZHEJIANG AOFENG ELECTRICAL

APPLANCES CO., LTD

NO.19, SHENBAO ROAD, BAIYANG  
STREET, WUYI COUNTY, JINHUA CITY  
ZHEJIANG PROVINCE, CHINA

(540)Madrid Application



八宝利  
BQBooli

(511) 30

(210) No. M/1811272

(220) 24/06/2024

(732) Longhai Babaoli Food Co., Ltd

No.368-2, Beizhou, Jintian Village, Zini

Town, Longhai District, Zhangzhou City

363100 Fujian Province, China

(540)Madrid Application



BELL Link 2

(511) 09, 28 and 41

(210) No. M/1811278

(220) 15/04/2024

(732) Euro Games Technology Ltd.

6 Panorama Sofia Str., Richhill Business

Center, ground floor, Vitosha region

BG-1766 Sofia, Bulgaria

(540)Madrid Application



(511) 09, 28 and 41

(210) No. M/1811279

(220) 15/04/2024

(732) Euro Games Technology Ltd.

6 Panorama Sofia Str., Richhill Business  
Center, ground floor, Vitosha region  
BG-1766 Sofia, Bulgaria

(540)Madrid Application



(511) 09, 28 and 41

(210) No. M/1811280

(220) 15/04/2024

(732) Euro Games Technology Ltd.

6 Panorama Sofia Str., Richhill Business  
Center, ground floor, Vitosha region  
BG-1766 Sofia, Bulgaria

(540)Madrid Application

**小龙坎**  
**SHOO LOONG KAN**

(511) 29 and 30

(210) No. M/1811309

(220) 11/04/2024

(732) CHENGDU XIAOLONGKAN CATERING  
MANAGEMENT CO., LTD.

Attached No.1, No.201, 2/F, Unit 1, No.50,  
Dong Da Jie, Jinjiang Dist., Chengdu 610000  
Sichuan, China

(540)Madrid Application

**Posh**

(511) 09

(210) No. M/1811343

(220) 03/06/2024

(732) Huawei Technologies Co., Ltd.

Administration Building Huawei Technologies  
Co., Ltd. Bantian, Longgang District 518129  
Shenzhen, China

(540)Madrid Application

**STARZ HOME**

(511) 18, 20, 24, 27 and 35

(210) No. M/1811353

(220) 11/04/2024

(732) Shanghai Shuixing Home Textile Co., Ltd.  
1487 Huhang Road, Fengxian District  
Shanghai, China

(540)Madrid Application

**HAWKWAY**

(511) 12

(210) No. M/1811383

(220) 20/06/2024

(732) QINGDAO HAWKWAY TYRE CO., LTD.  
Room 1066, 1/F, East Office Building, No.  
45, Beijing Road, Qianwan Bonded Port  
Area, Qingdao Area (Shandong) Pilot Free  
Trade Zone, China



(540)Madrid Application

**RICOTA**

(511) 20

(210) No. M/1811568

(220) 19/04/2024

(732) Chongqing Amity Machinery Co., Ltd.

28-5#, No. 200 Zhongshan 2 Road, Yuzhong

District 215000 Chongqing, China

(540)Madrid Application

**EDRA**

(511) 20

(210) No. M/1811576

(220) 02/08/2024

(732) EDRA S.p.A.

Via Livornese Est, 106 I-56030 Perignano

di Lari (PI), Italy

(540)Madrid Application



(511) 09, 28 and 41

(210) No. M/1811588

(220) 15/04/2024

(732) Euro Games Technology Ltd.

6 Panorama Sofia Str., Richhill Business  
Center, ground floor, Vitosha region  
BG-1766 Sofia, Bulgaria

(540)Madrid Application



(511) 07

(210) No. M/1811591

(220) 11/04/2024

(732) CHANGSHU TONGRUN AUTO

ACCESSORY CO., LTD.

New Longteng Industrial Park, Changshu  
Economic Development Zone Jiangsu  
Province, China

(540)Madrid Application

**乐堡士 lebosi**

(511) 43

(210) No. M/1811606

(220) 20/06/2024

(732) Beijing Lebaoshi Catering Management Co.,  
Ltd

1803, 15th Floor, Building 3, Courtyard 4,  
Leyuan Road, Daxing District Beijing, China

(540)Madrid Application

**BOJ**

(511) 03

(210) No. M/1811622

(220) 08/08/2024

(732) GOODAI GLOBAL INC.

502ho, 5F, 5, Digital-ro 26-gil, Guro-gu Seoul,  
Republic of Korea

(540)Madrid Application



(511) 29 and 30

(210) No. M/1811770

(220) 03/05/2024

(732) SEARA ALIMENTOS LTDA.

Av. Marginal Direita do Tietê, 500 - Bloco  
II - Subsolo - Sala 13, Vila Jaguará  
05118-100 São Paulo, Brazil

(540)Madrid Application



(511) 30

(210) No. M/1811816

(220) 14/12/2021

(732) Chongqing Dream Awaken Ancient Town

Culture Communication Co.,Ltd.

1-2, No.11, Nanqiao Renjia Garden, Jiangbei  
District Chongqing City, China

(540)Madrid Application

**STORMGATE**

(511) 09 and 41

(210) No. M/1811921

(220) 11/04/2024

(732) Frost Giant Studios, Inc.

2311 Live Oak Meadows Rd. Malibu CA  
90265, United States of America

(540)Madrid Application

**Amello**

(511) 09, 35, 36, 38, 39, 41 and 43

(210) No. M/1811931

(220) 19/04/2024

(732) TUI AG

Karl-Wiechert-Allee 23 30625 Hannover,  
Germany

(540)Madrid Application



(511) 09, 28 and 41

(210) No. M/1811943

(220) 13/05/2024

(732) Euro Games Technology Ltd.

6 Panorama Sofia Str., Richhill Business  
Center, ground floor, Vitosha Region  
BG-1766 Sofia, Bulgaria

(540)Madrid Application



(511) 09, 28 and 41

(210) No. M/1811947

(220) 13/05/2024

(732) Euro Games Technology Ltd.

6 Panorama Sofia Str., Richhill Business  
Center, ground floor, Vitosha Region  
BG-1766 Sofia, Bulgaria

(540)Madrid Application



(511) 06, 07, 09, 12, 27, 35, 36, 37, 39, 41 and 42

(210) No. M/1811957

(220) 15/04/2024

(732) HONDA MOTOR CO., LTD.

1-1, Minami-Aoyama 2-chome, Minato-ku  
Tokyo 107-8556, Japan

(540)Madrid Application



(511) 09 and 42

(210) No. M/1811977

(220) 27/05/2024

(732) MONTECY HOLDING LTD

Filippou, 11, Agios Dometios CY-2363  
Nicosia, Cyprus

(540)Madrid Application

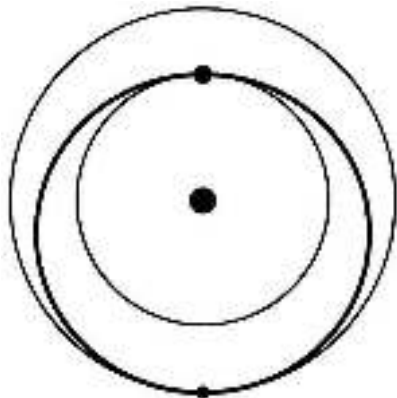

(511) 09, 38, 39 and 42

(210) No. M/1812106

(220) 21/03/2024

(732) SPACE EXPLORATION TECHNOLOGIES  
CORP.

1 ROCKET ROAD HAWTHORNE CA  
90250, UNITED STATES OF AMERICA

(540)Madrid Application

**LAKIAUTO**

(511) 06, 07, 08, 09, 11, 12 and 20

(210) No. M/1812134

(220) 20/05/2024

(732) Suzhou Dake Investment Consultation Co.,  
Ltd.

Room 618, Building Number 1, Lucky City  
Commercial Center, Suzhou Industrial Park,  
Suzhou City 215000 Jiangsu Province, China



(540)Madrid Application



LINGAR

(511) 05 and 32

(210) No. M/1812182

(220) 06/08/2024

(732) RAJARANI HERBS LIMITED

PARTNERSHIP

2/29 Moo 10 Bana Sub-district 94000

Mueang Pattani District, Pattani, Thailand

(540)Madrid Application



L

(511) 03, 04, 05, 08, 09, 14, 16, 18, 20, 21, 24, 25,  
35, 43 and 44

(210) No. M/1812205

(220) 12/04/2024

(732) LABORATOIRES M&L

Zone Industrielle Saint-Maurice F-04100

Manosque, France

(540)Madrid Application

**Flaming Selection**

(511) 09, 28 and 41

(210) No. M/1812276

(220) 13/05/2024

(732) Euro Games Technology Ltd.

6 Panorama Sofia Str., Richhill Business

Center, ground floor, Vitosha Region BG-1766

Sofia, Bulgaria

(540)Madrid Application

**GZE**

(511) 03

(210) No. M/1812332

(220) 27/06/2024

(732) Guangzhou Yilong Cosmetics Co., Ltd.

Room 2101, No. 33-15, Jinshi 3rd Road,

Dayuan Street, Baiyun District, Guangzhou

510000 Guangdong, China

(540)Madrid Application



(511) 09, 16, 41 and 42

(210) No. M/1812441

(220) 11/06/2024

(732) STUDIO HARCOURT

6 rue de Lota F-75116 Paris, France

(540)Madrid Application

**BOLERO**

(511) 05, 30 and 32

(210) No. M/0743112

(220) 17/07/2024

(732) BOLERO & Co Ltd.

No 1, Bolero Str. BG-2180 Etropole, Bulgaria

(540)Madrid Application

人保

(511) 36

(210) No. M/1203558

(220) 12/09/2024

(732) THE PEOPLE'S INSURANCE COMPANY  
(GROUP) OF CHINA LIMITED

69, Dongheyanjie, Xuanwumen 100052  
BEIJING, China

(540)Madrid Application

HomeFacial Pro

(511) 03, 35 and 42

(210) No. M/1610517

(220) 19/06/2024

(732) Guangzhou Eggshell Network Technology  
Co.,Ltd.

Suite 1701, No.1 Tingyuan Road, Haizhu  
District, Guangzhou City 510000 Guangdong  
Province, China

(540)Madrid Application



(511) 09  
(210) No. M/1621778  
(220) 17/09/2024  
(732) GOLDMUND MONACO S.A.M.  
25, bd du Larvotto MC-98000 MONACO,  
Monaco

(540)Madrid Application



(511) 05, 10 and 35  
(210) No. M/1648000  
(220) 01/07/2024  
(732) Guangzhou Rainhome Pharm & Tech Co.,  
Ltd  
2nd floor and 5th floor, Building 6, No.10,  
Yongsheng Road, Huangpu District,  
Guangzhou Guangdong Province, China

(540)Madrid Application



(511) 03, 05 and 10

(210) No. M/1706188

(220) 13/08/2024

(732) Beiersdorf AG

Beiersdorfstrasse 1-9 22529 Hamburg,  
Germany

(540)Madrid Application

**GENTLE MONSTER**

(511) 03

(210) No. M/1735166

(220) 23/07/2024

(732) IICOMBINED Co., Ltd.

41, EOULMADANG-RO 5-GIL, MAPO-GU  
SEOUL, Republic of Korea

(540)Madrid Application

**GENTLE MONSTER**

(511) 18

(210) No. M/1735167

(220) 23/07/2024

(732) IICOMBINED Co., Ltd.

41, EOULMADANG-RO 5-GIL, MAPO-GU  
SEOUL, Republic of Korea

(540)Madrid Application

GENTLE MONSTER

(511) 14

(210) No. M/1738620

(220) 23/07/2024

(732) IICOMBINED Co., Ltd.

41, EOULMADANG-RO 5-GIL, MAPO-GU  
SEOUL, REPUBLIC OF KOREA

(540)Madrid Application

**GENTLE MONSTER**

(511) 25

(210) No. M/1750578

(220) 23/07/2024

(732) IICOMBINED Co., Ltd.

41, Eoulmadang-ro 5-gil, Mapo-gu Seoul,  
Republic of Korea

(540)Madrid Application

**PETKIT**

(511) 03, 07, 08, 09, 11, 18, 20, 21, 28 and 31

(210) No. M/1812472

(220) 11/04/2024

(732) PETKIT Network Technology (Shanghai)  
Co., Ltd.

Room 4139, Building 2, No. 588, Zixing  
Road, Minhang District 201100 Shanghai,  
China



(540)Madrid Application

**gootee**

(511) 16, 29, 30, 32, 35 and 43

(210) No. M/1812473

(220) 26/04/2024

(732) Guming Technology Group Co., Ltd.

The north side of class I highway at Daxi  
Town, Wenling City, Taizhou City 317525  
Zhejiang Province, China

(540)Madrid Application

**goodme**

(511) 16, 29, 30, 32, 35 and 43

(210) No. M/1812474

(220) 26/04/2024

(732) Guming Technology Group Co., Ltd.

The north side of class I highway at Daxi  
Town, Wenling City, Taizhou City 317525  
Zhejiang Province, China

(540)Madrid Application

**G'nature**

(511) 30

(210) No. M/1812479

(220) 25/04/2024

(732) BEIJING ALLIED FAXI FOOD CO., LTD.

Jinma Industrial Zone, Shunyi District

101300 Beijing, China

(540)Madrid Application

**SABRE**

(511) 09, 35, 36, 38, 39, 41, 42 and 43

(210) No. M/1812491

(220) 20/10/2023

(732) SABRE GBL INC.

3150 Sabre Drive Southlake TX 76092,

United States of America

(540)Madrid Application



(511) 09, 35 and 42

(210) No. M/1812674

(220) 31/05/2024

(732) MAGIC PRICES

1 Rue du Guesclin F-44000 Nantes, France

(540)Madrid Application

The logo for SkyBlue is the text "SkyBlue" written in a large, bold, black, sans-serif font.

(511) 09

(210) No. M/1812690

(220) 11/04/2024

(732) JingAo Solar Co., Ltd.

Jinglong Street, Ningjin County, Xingtai City

Hebei Province, China

(540)Madrid Application

The logo consists of the number '100' in a large, bold, blue font with a white outline, followed by the words 'SUPER POWER' in a smaller, bold, red font with a white outline. The entire logo has a slight drop shadow effect.

(511) 09, 28 and 41

(210) No. M/1812692

(220) 29/04/2024

(732) Euro Games Technology Ltd.

6 Panorama Sofia Str., Richhill Business  
Center, ground floor, Vitosha Region  
BG-1766 Sofia, Bulgaria

(540)Madrid Application

The logo features the words 'MOM'S PIZZA' in a bold, black, serif font. The text is centered and has a slight shadow effect.

(511) 30 and 43

(210) No. M/1812762

(220) 07/08/2024

(732) MOM'S TOUCH&Co.

5F, 6F, 7F, 8F, 5, Samil-daero 6-gil, Jung-gu  
Seoul, Republic of Korea

(540)Madrid Application

The logo for SEPN, featuring the letters 'SEPN' in a bold, italicized, sans-serif font. The letter 'A' is replaced by a triangle pointing upwards.

(511) 11

(210) No. M/1812779

(220) 17/06/2024

(732) Taizhou Weiye Refrigeration Equipment Co.,  
Ltd

1F, Building 2, No. 699, Qinglongpu Road,  
Eastern New Center, Taizhouwan New  
District, Taizhou Zhejiang, China

(540)Madrid Application

The logo for BELZ, featuring the letters 'BELZ' in a bold, sans-serif font.

(511) 11 and 21

(210) No. M/1812783

(220) 29/03/2024

(732) Wenzhou Chenkai Sanitary Ware Co., Ltd.

No.177, Hairong Road, Haicheng Street,  
Wenzhou Economic And Technological  
Development Zone, Wenzhou Zhejiang,  
China

(540)Madrid Application

The logo for ANNWA consists of the word "ANNWA" in a bold, blue, sans-serif font. The letters are slightly shadowed, giving it a 3D appearance.

(511) 11 and 19

(210) No. M/1812791

(220) 25/10/2023

(732) Foshan Gaoming Annwa Ceramic Sanitary  
Ware Co., Ltd  
Sanming Road, He Cheng Avenue, Cangjiang  
Industrial Zone, Sanzhou Town, Gaoming  
Area, Foshan City Guangdong Province,  
China

(540)Madrid Application

The logo for 40 SUPER POWER features the number "40" in a large, blue, 3D font, followed by the words "SUPER POWER" in a smaller, red, 3D font with a yellow outline.

(511) 09, 28 and 41

(210) No. M/1812792

(220) 29/04/2024

(732) Euro Games Technology Ltd.  
6 Panorama Sofia Str., Richhill Business  
Center, ground floor, Vitosha Region  
BG-1766 Sofia, Bulgaria

(540)Madrid Application

**more Burning Power**

(511) 09, 28 and 41

(210) No. M/1812793

(220) 29/04/2024

(732) Euro Games Technology Ltd.

6 Panorama Sofia Str., Richhill Business

Center, ground floor, Vitosha Region BG-1766

Sofia, Bulgaria

(540)Madrid Application

**KIA PV3**

(511) 12

(210) No. M/1812810

(220) 08/07/2024

(732) Kia Corporation

12, Heolleung-ro, Seocho-gu Seoul 06797,

Republic of Korea

(540)Madrid Application

**KIA PVS**

(511) 12

(210) No. M/1812811

(220) 08/07/2024

(732) Kia Corporation

12, Heolleung-ro, Seocho-gu Seoul 06797,  
Republic of Korea

(540)Madrid Application

**DYNAPULSE**

(511) 14

(210) No. M/1812885

(220) 28/06/2024

(732) ROLEX SA

Rue François-Dussaud 3-5-7 CH-1211  
Genève 26, Switzerland



(540)Madrid Application

The logo for 'ARROW' is displayed in a bold, black, sans-serif font. The letters are evenly spaced and have a consistent thickness.

(511) 11 and 19

(210) No. M/1812915

(220) 25/10/2023

(732) Arrow Home Group Co., Ltd.

1 Tower, No. 1 Kangyu Three Road, Nanshan  
Town, Sanshui District, Foshan City  
Guangdong Province, China

(540)Madrid Application

The logo for 'FAENZA' is displayed in a bold, black, sans-serif font. The letters are evenly spaced and have a consistent thickness.

(511) 11 and 19

(210) No. M/1812916

(220) 25/10/2023

(732) FOSHAN CITY FAENZA SANITARY

WARE CO., LTD

Sanzhou Park, East Zone, Cangjiang Ind.

Zone, Gaoming District, Foshan City 528511

Guangdong Province, China

(540)Madrid Application

**M&G STATIONERY**

(511) 16

(210) No. M/1812990

(220) 12/06/2024

(732) Shanghai M&G Stationery Inc.

Building 3, No. 3469 Jinqian Road, Fengxian  
District Shanghai, China

(540)Madrid Application

**Lucky Circle**

(511) 09, 28 and 41

(210) No. M/1813067

(220) 29/04/2024

(732) Euro Games Technology Ltd.

6 Panorama Sofia Str., Richhill Business  
Center, ground floor, Vitosha Region BG-1766  
Sofia, Bulgaria

(540)Madrid Application



(511) 05, 06, 08, 09, 10, 11, 14, 16, 18, 25, 28 and 42

(210) No. M/1813162

(220) 28/05/2024

(732) BLUE ORIGIN MANAGEMENT

CONSULTANT PTE. LTD.

73 UPPER PAYA LEBAR ROAD, #07-02J

CENTRO BIANCO SINGAPORE 534818

(540)Madrid Application



(511) 09, 28 and 41

(210) No. M/1813181

(220) 13/05/2024

(732) Euro Games Technology Ltd.

6 Panorama Sofia Str., Richhill Business

Center, ground floor, Vitosha Region

BG-1766 Sofia, Bulgaria

(540)Madrid Application

I SNT

(511) 07

(210) No. M/1813288

(220) 08/07/2024

(732) ISNT (Suzhou) Machine Tool Co., Ltd.  
No. 6, Xingwang Road, Huangqiao Street,  
Xiangcheng District, Suzhou City 215100  
Jiangsu Province, China

(540)Madrid Application

**Clover Hit**

(511) 09, 28, 41 and 42

(210) No. M/1813457

(220) 10/04/2024

(732) EGT DIGITAL LTD.  
6, "Panorama Sofia" Str. Business Center  
"Richhill", block A BG-1766 Sofia, Bulgaria

(540)Madrid Application

**INSTAR**

(511) 03, 06, 07, 08, 09, 11, 12 and 21

(210) No. M/1813473

(220) 10/07/2024

(732) QINGDAO CHANG NING IMPORT AND  
EXPORT CO., LTD.

100 Hong Kong Road, office 2003 266071  
Qingdao, China

(540)Madrid Application

**HAVANOVE**

(511) 34

(210) No. M/1813485

(220) 08/08/2024

(732) Gulbahar Tobacco International FZE

P.O. Box 61401, Jebel Ali Free Zone Dubai,  
United Arab Emirates

(540)Madrid Application

**APPLE  
INTELLIGENCE**

(511) 09

(210) No. M/1813515

(220) 26/08/2024

(732) Apple Inc.

One Apple Park Way Cupertino CA 95014,  
United States of America

(540)Madrid Application

**HILTON. FOR THE  
STAY.**

(511) 43

(210) No. M/1813627

(220) 16/08/2024

(732) Hilton Worldwide Manage Limited

Maple Court Central Park, Reeds Crescent  
Watford, Hertfordshire WD24 4QQ,  
United Kingdom

(540)Madrid Application

The logo for "Sugar Duke" features the words "Sugar Duke" in a bold, yellow, sans-serif font with a thick purple outline. The letters are slightly shadowed, giving the logo a three-dimensional appearance.

(511) 09, 28, 41 and 42

(210) No. M/1813654

(220) 10/04/2024

(732) EGT DIGITAL LTD.

6, "Panorama Sofia" Str. Business Center

"Richhill", block A BG-1766 Sofia, Bulgaria

(540)Madrid Application

The logo for "Rongsheng" consists of a solid grey vertical bar on the left. To its right is a stylized grey graphic of three curved lines forming a partial arc, resembling a rainbow or a stylized 'R'. Below this graphic, the word "RONGSHENG" is written in a bold, grey, sans-serif font.

(511) 01, 04 and 23

(210) No. M/1813668

(220) 10/04/2024

(732) Rongsheng Petrochemical Co., Ltd.

NO.98 Hongyang Road, Yinong Town,

Xiaoshan District 311245 Zhejiang Province,

China

(540)Madrid Application

The Verizon logo is displayed in a bold, red, lowercase sans-serif font. The letter 'v' is slightly larger and more prominent than the other letters.

(511) 09, 37, 38 and 42

(210) No. M/1813711

(220) 07/08/2024

(732) Verizon Trademark Services LLC

1300 I Street, NW, Suite 500 East

Washington DC 20005,

United States of America

(540)Madrid Application

The logo for UBESLO is presented in a bold, black, uppercase sans-serif font.

(511) 05

(210) No. M/1813742

(220) 30/08/2024

(732) NewAmsterdam Pharma B.V.

Gooimeer 2 35 NL-1411 DC Naarden,

The Netherlands



(540)Madrid Application

findense

(511) 03

(210) No. M/1813746

(220) 13/09/2024

(732) Dongguan Blue Origin Brand Management  
Co., Ltd.

Room 1501, Yujing Building, No. 577

Dongcheng Road, Dongcheng District,

Dongguan Guangdong Province, China

(540)Madrid Application

**MOSI-OA-TUNYA  
GOLD COIN**

(511) 36

(210) No. M/1813755

(220) 23/05/2024

(732) RESERVE BANK OF ZIMBABWE

Samora Machel Avenue 80 Harare, Zimbabwe

(540)Madrid Application



(511) 14

(210) No. M/1813756

(220) 23/05/2024

(732) RESERVE BANK OF ZIMBABWE

Samora Machel Avenue 80 Harare,  
Zimbabwe

(540)Madrid Application



(511) 32 and 33

(210) No. M/1813758

(220) 24/09/2024

(732) Carlsberg Breweries A/S

J.C. Jacobsens Gade 1 DK-1799  
Copenhagen V, Denmark

(540)Madrid Application

**CAMPA**

(511) 32

(210) No. M/1814070

(220) 14/08/2024

(732) Reliance Retail Limited

3rd Floor, Court House, Lokmanya Tilak

Marg, Dhobi Talao, Mumbai 400 002

Maharashtra, India

(540)Madrid Application

**DURAJACK**

(511) 07

(210) No. M/1814118

(220) 16/05/2024

(732) Immco Pte Ltd.

7030 ANG MO KIO AVENUE 5, #04-07

NORTHSTAR @ AMK SINGAPORE 569880

(540)Madrid Application



(511) 42

(210) No. M/1814141

(220) 27/08/2024

(732) VLS INVESTMENTS PTE. LTD.

3 RAFFLES PLACE, #06-01 BHARAT  
BUILDING SINGAPORE 048617

(540)Madrid Application



(511) 12

(210) No. M/1814178

(220) 17/05/2024

(732) Skywell New Energy Vehicles Group Co.,  
Ltd.

No.369 Binhuai Road, Zhetang Town,  
Lishui District, Nanjing Jiangsu, China

(540)Madrid Application



(511) 01, 02, 06, 07, 08, 09, 11, 16, 17, 19, 20, 27, 37, 41, 42 and 45

(210) No. M/1814185

(220) 09/07/2024

(732) Knauf Gips KG

Am Bahnhof 7 97346 Iphofen, Germany

(540)Madrid Application

**ROULETTE  
FRENZY**

(511) 09, 28, 41 and 42

(210) No. M/1814196

(220) 08/03/2024

(732) Interblock d.o.o.

6900 S Decatur Blvd Ste 100 Las Vegas NV  
89118, United States of America

(540)Madrid Application

BEURRELIS

(511) 03

(210) No. M/1814203

(220) 03/06/2024

(732) BLUE ORIGIN MANAGEMENT  
CONSULTANT PTE. LTD.

73 UPPER PAYA LEBAR ROAD, #07-02J  
CENTRO BIANCO SINGAPORE 534818

(540)Madrid Application

Fambam

(511) 16

(210) No. M/1814204

(220) 03/06/2024

(732) BLUE ORIGIN MANAGEMENT  
CONSULTANT PTE. LTD.

73 UPPER PAYA LEBAR ROAD, #07-02J  
CENTRO BIANCO SINGAPORE 534818

(540)Madrid Application

SENSE MORE.

(511) 04

(210) No. M/1814205

(220) 03/06/2024

(732) BLUE ORIGIN MANAGEMENT  
CONSULTANT PTE. LTD.

73 UPPER PAYA LEBAR ROAD, #07-02J  
CENTRO BIANCO SINGAPORE 534818

(540)Madrid Application

Medibles

(511) 05 and 10

(210) No. M/1814206

(220) 04/06/2024

(732) BLUE ORIGIN MANAGEMENT  
CONSULTANT PTE. LTD.

73 UPPER PAYA LEBAR ROAD, #07-02J  
CENTRO BIANCO SINGAPORE 534818

(540)Madrid Application

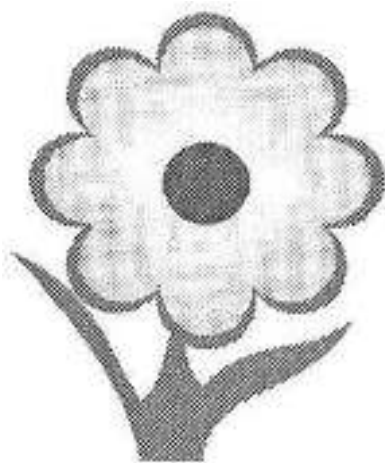

(511) 30

(210) No. M/1814271

(220) 19/06/2024

(732) Guangzhou Flower Flavours & Fragrances  
Co., Ltd

No. 1 Dongkeng street, Dongfeng East Street,  
North Baiyun Avenue, Yongping Street,  
Baiyun District, Guangzhou 510000  
Guangdong, China

(540)Madrid Application



(511) 33

(210) No. M/1814287

(220) 26/07/2024

(732) NOBLEWOOD LIMITED

Makariou III, 206, Chrysalia Court, 5th floor  
CY-3030 Limassol, Cyprus



(540)Madrid Application



(511) 14, 35, 36 and 43

(210) No. M/1814317

(220) 29/05/2024

(732) SOLUXURY HMC

82 rue Henri Farman F-92130

Issy-les-Moulineaux, France

(540)Madrid Application

**POP NOW**

(511) 30

(210) No. M/1814384

(220) 25/06/2024

(732) LOTTE CO., LTD.

20-1, Nishi-Shinjuku 3-chome,

Shinjuku-ku Tokyo, Japan

(540)Madrid Application

**NISUVI**

(511) 03, 05, 09, 10, 11, 35, 41, 42 and 44

(210) No. M/1814482

(220) 18/08/2023

(732) 3M Healthcare Intellectual Properties

Company

2501 Hudson Road, 3M Center St Paul MN

55144, United States of America

(540)Madrid Application

**ArtfulColor**

(511) 09

(210) No. M/1814496

(220) 20/06/2024

(732) SAMSUNG ELECTRONICS CO., LTD.

129, Samsung-ro, Yeongtong-gu, Suwon-si,

Gyeonggi-do, Republic of Korea

(540)Madrid Application

**PHOINN**

(511) 43

(210) No. M/1814501

(220) 24/06/2024

(732) Golden Gate Group Joint Stock Company  
No 60 Giang Van Minh Street, Doi Can  
Ward, Ba Dinh District Ha Noi, Vietnam

(540)Madrid Application

**SPACE WALKERS**

(511) 30

(210) No. M/1814581

(220) 16/08/2024

(732) Redwood Brand Holdings LLC  
14400 NW 112th Ave Hialeah Gardens FL  
33018, United States of America

(540)Madrid Application

**HOJITA**

(511) 06, 07, 08, 09 and 11

(210) No. M/1814625

(220) 31/05/2024

(732) Ingco Tools Co., Limited

Building 2, No. 20 Dagang Road, Fuqiao

Town, Taicang City 215000 Jiangsu Province,

China

(540)Madrid Application

**FLAMING  
SELECTION**

(511) 09, 28 and 41

(210) No. M/1814742

(220) 13/05/2024

(732) Euro Games Technology Ltd.

6 Panorama Sofia Str., Richhill Business

Center, ground floor, Vitosha Region

BG-1766 Sofia, Bulgaria

(540)Madrid Application

**SEA CHANGE  
FOUNDATION**

(511) 35 and 41

(210) No. M/1814758

(220) 04/06/2024

(732) Sea Change Foundation

3 Lagoon Drive, Suite 400 Redwood City CA  
94065, United States of America

(540)Madrid Application

**Bucalu**

(511) 06 and 19

(210) No. M/1814952

(220) 02/07/2024

(732) Guangdong Bucalu Curtain Wall Window &  
Door System Co. Ltd.

No.14 Community, Baijia Industrial Park,  
High-tech Development Zone, Qingyuan City  
511500 Guangdong Province, China

(540)Madrid Application

**CARVICO**

(511) 09, 20, 22, 23, 24, 25, 35, 38, 40 and 42

(210) No. M/1815053

(220) 10/11/2023

(732) CARVICO S.P.A.

Via Don A. Pedrinelli, 96 I-24030 CARVICO  
(BG), Italy

(540)Madrid Application



(511) 35, 36 and 41

(210) No. M/1815094

(220) 04/06/2024

(732) SEA CHANGE FOUNDATION

3 Lagoon Drive, Suite 400 Redwood City CA  
94065, United States of America

(540)Madrid Application

**CANDY**

(511) 07, 09, 11 and 37

(210) No. M/1815095

(220) 24/04/2024

(732) CANDY S.P.A.

Via Privata Eden Fumagalli S.N.C. I-20861  
BRUGHERIO, MONZA E BRIANZA, Italy

(540)Madrid Application

**SHEGLAM**

(511) 03 and 35

(210) No. M/1815197

(220) 26/08/2024

(732) ROADGET BUSINESS PTE. LTD.

12 MARINA BOULEVARD, #15-01  
MARINA BAY FINANCIAL CENTRE  
SINGAPORE 018982

(540)Madrid Application



(511) 09, 28 and 41

(210) No. M/1815237

(220) 06/12/2023

(732) Društvo za trgovija i uslugi EVRO GEJMS

TEHNOLODŽI DOOEL Skopje

Ul. Boris Trajkovski br.214 a, Kisela Voda

1000 Skopje, Macedonia, The Former

Yugoslav Republic of North Macedonia

(MK)

(540)Madrid Application

**Horal**

(511) 32

(210) No. M/1815258

(220) 06/08/2024

(732) Albion plus s.r.o.

Mezilesí 2068/40 CZ-193 00 Praha 9,

Horní Počernice, Czech Republic



(540)Madrid Application

ONVO

(511) 09, 12 and 37

(210) No. M/1815318

(220) 24/05/2024

(732) NIO Technology (Anhui) Co., Ltd.

Building F, Hengchuang Intelligent

Technology Park, Susong Rd. 3963,

Economic and Technological Development

Area, Hefei City Anhui Province, China

(540)Madrid Application

agafar

(511) 03, 35 and 44

(210) No. M/1815323

(220) 17/07/2024

(732) CHOI, CHUNKI

2319-1204, 36, Doyak-ro, Wonmi-gu,

Bucheon-si Gyeonggi-do, Republic of Korea

(540)Madrid Application

**LUBRILOG**

(511) 01 and 04

(210) No. M/1815331

(220) 06/08/2024

(732) LUBRILOG

18 Rue Nicolas Appert, ZI LES CHASSES F-  
26100 Romans-sur-Isère, France

## ພາກທີ IV

### (Part IV)

#### ເຄື່ອງໝາຍການຄ້າຜ່ານລະບົບມາດຣິດ

### Trademarks via Madrid Protocol

## 2. ຜົນການຈົດທະບຽນ

### (Registration)

#### ຄຳອະທິບາຍກ່ຽວກັບລະຫັດຫຍໍ້

#### (Introduction of Codes)

- (540) ເຄື່ອງໝາຍການຄ້າ (Trademark)
- (511) ໝວດ (Nice Classification)
- (210) ເລກທີ ຄຳຮ້ອງ (Number of the application)
- (220) ວັນທີ ຍື່ນຄຳຮ້ອງ (Date of filing of the application)
- (732) ຊື່ ແລະ ທີ່ຢູ່ ຂອງຜູ້ຍື່ນຄຳຮ້ອງ (Name and Address of applicant)
- (111) ເລກທີການຈົດທະບຽນເຄື່ອງໝາຍການຄ້າ (Number of the registration)
- (180) ວັນໝົດອາຍຸຂອງການຈົດທະບຽນ (Expiration date of the registration)

(540) Madrid Registration



(511) 29 and 43

(210) No. M/1284544

(220) 05/10/2023

(732) BHC Co., Ltd.

2F, TS Bldg, 299, Olympic-ro, Songpa-gu

Seoul, Republic of Korea

(111) No. M/1284544

(180) 19/11/2025

(540) Madrid Registration

**VEEV**

(511) 09, 11 and 34

(210) No. M/1305642

(220) 10/10/2023

(732) Philip Morris Products S.A.

Quai Jeanrenaud 3 CH-2000 Neuchâtel,

Switzerland

(111) No. M/1305642

(180) 18/05/2026

(540) Madrid Registration

**LEVIA**

(511) 34

(210) No. M/1716062

(220) 11/10/2023

(732) Philip Morris Products S.A.

Quai Jeanrenaud 3 CH-2000 Neuchâtel,

Switzerland

(111) No. M/1716062

(180) 22/11/2032

(540) Madrid Registration

**DELIA**

(511) 34

(210) No. M/1725821

(220) 11/10/2023

(732) Philip Morris Products S.A.

Quai Jeanrenaud 3 CH-2000 Neuchâtel,

Switzerland

(111) No. M/1725821

(180) 06/03/2033

(540) Madrid Registration

**LONG LIVE THE  
LAZY**

(511) 20

(210) No. M/1758762

(220) 19/09/2023

(732) La-Z-Boy Incorporated

One La-Z-Boy Drive Monroe MI 48162,

United States of America

(111) No. M/1758762

(180) 19/09/2033

(540) Madrid Registration

**Laneige Peony &  
Collagen Complex**

(511) 03

(210) No. M/1759207

(220) 26/09/2023

(732) Amorepacific Corporation

100, Hangang-daero, Yongsan-gu Seoul,

Republic of Korea

(111) No. M/1759207

(180) 26/09/2033

(540) Madrid Registration



(511) 30

(210) No. M/1759448

(220) 15/09/2023

(732) Nisshin Seifun Group Inc.

25, Kanda-Nishiki-cho 1-chome, Chiyoda-ku

Tokyo 101-8441, Japan

(111) No. M/1759448

(180) 15/09/2033

(540) Madrid Registration

**SEEKRUN**

(511) 09, 12 and 35

(210) No. M/1760312

(220) 09/10/2023

(732) Higo Technology Suzhou CO., LTD.

Building 6, Launching Area of Yangtze River

Delta International Research and

Development Zone, No. 286 Qinglonggang

Road, High-speed Rail New Town

Xiangcheng, China

(111) No. M/1760312

(180) 09/10/2033

(540) Madrid Registration



(511) 29

(210) No. M/1760398

(220) 27/09/2023

(732) Zhangzhou Tan Co., Ltd.

22nd Floor, Block 1, Liyuan Plaza, East

Nanchang Road, Zhangzhou 363000 Fujian,  
China

(111) No. M/1760398

(180) 27/09/2033

(540) Madrid Registration



(511) 03

(210) No. M/1760736

(220) 15/09/2023

(732) Shanghai Xingwu Brand Management Co.,

Ltd

J, 1st Floor, No. 185, Moyu Road, Jiading

District Shanghai, China

(111) No. M/1760736

(180) 15/09/2033



(540) Madrid Registration

CerviCARE AI

(511) 09 and 44

(210) No. M/1760895

(220) 05/10/2023

(732) NTL HEALTHCARE Co., Ltd

710-713, 42 Changeop-ro, Sujeong-gu

Seongnam-si, Gyeonggi-do,

Republic of Korea

(111) No. M/1760895

(180) 05/10/2033

(540) Madrid Registration

Driscoll's

(511) 31

(210) No. M/1761003

(220) 05/10/2023

(732) DRISCOLL'S, INC.

345 WESTRIDGE DRIVE WATSONVILLE

CA 95076, United States of America

(111) No. M/1761003

(180) 05/10/2033

(540) Madrid Registration

The logo for JOYOUS features the word "JOYOUS" in a bold, sans-serif font. The letter "O" is replaced by a stylized black and white icon of a person's head with a smiling face.

(511) 08

(210) No. M/1761314

(220) 26/09/2023

(732) STAR RICH ENTERPRISE CO., LTD.  
450/8 RAMA 3 ROAD, BANG KHLO SUB-  
DISTRICT 10120 BANG KHO LAEM  
DISTRICT, BANGKOK, THAILAND

(111) No. M/1761314

(180) 26/09/2033

(540) Madrid Registration

The logo for IT&LY HAIR FASHION features the words "IT&LY" in a large, stylized, serif font. The ampersand is highly decorative. Below "IT&LY" are the words "HAIR FASHION" in a smaller, clean, sans-serif font.

(511) 03

(210) No. M/1762030

(220) 20/09/2023

(732) G.V.F.- GIVIEFFE S.p.A.  
Via G. Falcone, 8 I-20080 VERNATE  
(Milano), Italy

(111) No. M/1762030

(180) 20/09/2033

(540) Madrid Registration

LEME

(511) 34

(210) No. M/1762057

(220) 21/09/2023

(732) LEME INTERNATIONAL PTE. LTD.

50 RAFFLES PLACE, #34-04 SINGAPORE

LAND TOWER SINGAPORE 048623

(111) No. M/1762057

(180) 21/09/2033

(540) Madrid Registration



(511) 29

(210) No. M/1762467

(220) 22/09/2023

(732) SUNSUSOLUTION COMPANY LIMITED

22/14 Mu 10 10540 Bang Kaeo Sub-district,

Bang Phli District, Samut Prakan, Thailand

(111) No. M/1762467

(180) 22/09/2033

(540) Madrid Registration

**DRISCOLL'S**

(511) 31

(210) No. M/1762516

(220) 05/10/2023

(732) Driscoll's, Inc.

345 Westridge Drive Watsonville CA 95076,

United States of America

(111) No. M/1762516

(180) 05/10/2033

(540) Madrid Registration

**N I G A O**

(511) 03

(210) No. M/1762521

(220) 21/09/2023

(732) Beauty Blend Co., Ltd.

87 Moo 6, Soi Krathumlom 22,

Phuttamonthon sai 4 Road, Krathumlom

Sub-district 73220 Samphran District,

Nakhonpathom, Thailand

(111) No. M/1762521

(180) 21/09/2033

(540) Madrid Registration

**E11EVEN**

(511) 25, 33 and 43

(210) No. M/1762956

(220) 05/10/2023

(732) GR OPCO, LLC

29 N.E. 11th Street Miami FL 33132,

United States of America

(111) No. M/1762956

(180) 05/10/2033

(540) Madrid Registration

**HIFIMAN**

(511) 09

(210) No. M/1762972

(220) 27/09/2023

(732) Kunshan Haifeiman Technology Group Co.,

Ltd

2001 Yingbin West Road, Bacheng Town,

Kunshan City Jiangsu Province, China

(111) No. M/1762972

(180) 27/09/2033

(540) Madrid Registration



(511) 28

(210) No. M/1763175

(220) 09/10/2023

(732) Fuan Ecoey Craft Co.,Ltd

Room 202, Building 7-1, Guang Yi Street,

No. 127 North Plaza Road, Yang Tou, FuAn

City, Ning De City 518000 Fujian, China

(111) No. M/1763175

(180) 09/10/2033

(540) Madrid Registration



(511) 16

(210) No. M/1763218

(220) 13/09/2023

(732) ZHEJIANG YIWU KEBIAO PEN-MAKING

CO., LTD.

No.757 Chengdian South Road,

Yiwu Zhejiang Province, China

(111) No. M/1763218

(180) 13/09/2033

(540) Madrid Registration

The logo for IMXS, consisting of the letters 'I', 'M', 'X', and 'S' in a bold, black, sans-serif font. The 'I' is a solid vertical bar, while the other letters have a stylized, slightly irregular appearance.

(511) 14, 18, 25 and 30

(210) No. M/1763238

(220) 14/09/2023

(732) Jiangxi Maisi Clothing Co., Ltd.

Area A10-4, 699 Creative Workshop, No.  
699 Shanghai Road, Qingshanhu District,  
Nanchang City 330000 Jiangxi Province,  
China

(111) No. M/1763238

(180) 14/09/2033

(540) Madrid Registration

The logo for BESTWES, consisting of the letters 'B', 'E', 'S', 'T', 'W', 'E', 'S' in a bold, black, sans-serif font.

(511) 34

(210) No. M/1763242

(220) 27/09/2023

(732) HUMBLE GRACE LIMITED

19H Maxgrand Plaza, No.3 Tai Yau Street,  
San Po Kong, Kowloon Hong Kong, China

(111) No. M/1763242

(180) 27/09/2033

(540) Madrid Registration



(511) 35, 41 and 45

(210) No. M/1763444

(220) 27/09/2023

(732) China Council for the Promotion of  
International Trade

No.1, Fuxingmenwai Street, Xicheng District  
100860 Beijing, China

(111) No. M/1763444

(180) 27/09/2033

(540) Madrid Registration



(511) 09 and 42

(210) No. M/1763539

(220) 04/10/2023

(732) Tractors Petroleum Services Sdn Bhd

No 1, Jalan Puchong, Taman Perindustrian  
Puchong Utama, 47100 Puchong Selangor,  
Malaysia

(111) No. M/1763539

(180) 04/10/2033



(540) Madrid Registration

**BECK'S**

(511) 32 and 43

(210) No. M/0808436

(220) 18/10/2023

(732) Brauerei Beck & Co. GmbH

Am Deich 18/19 28199 Bremen, Germany

(111) No. M/0808436

(180) 30/07/2033

(540) Madrid Registration

**LUXVISAGE**

(511) 03 and 44

(210) No. M/1409994

(220) 25/10/2023

(732) LUX-VISAGE Limited Liability Company

ul. Dzerzhinskaya 28, Zaslavl, Minskiy rayon

223036 Minskaya obl., Belarus

(111) No. M/1409994

(180) 28/02/2028

(540) Madrid Registration



**DR. VRANJES**

(511) 03, 04 and 35

(210) No. M/1443392

(220) 06/11/2023

(732) Dr. Vranjes Firenze S.p.A.

Via Sandro Pertini, 5, Frazione Antella

I-50012 Bagno a Ripoli (FI), Italy

(111) No. M/1443392

(180) 21/06/2028

(540) Madrid Registration

**AOAS**

(511) 09

(210) No. M/1526426

(220) 07/11/2023

(732) Zeng wei qin

17679 business space, 7th Street, third floor,  
gate 38, zone 2, International Trade City,

Yiwu City Zhejiang Province, China

(111) No. M/1526426

(180) 23/03/2030

(540) Madrid Registration

## **BONDS**

(511) 34

(210) No. M/1655824

(220) 19/10/2023

(732) Philip Morris Products S.A.

Quai Jeanrenaud 3 CH-2000 Neuchâtel,

Switzerland

(111) No. M/1655824

(180) 20/01/2032

(540) Madrid Registration

## **WellO2 MyBreath**

(511) 10

(210) No. M/1722025

(220) 02/11/2023

(732) WellO2 Oy

Verstaankatu 5 A 3 FI-33100 Tampere,

Finland

(111) No. M/1722025

(180) 11/01/2033

(540) Madrid Registration



(511) 05, 32 and 33

(210) No. M/1727586

(220) 31/10/2023

(732) Philipp Heift; Christine Heift and Corinna Heift

Goldenbergstr. 46 50374 Erftstadt, Germany;

Goldenbergstr. 46 50374 Erftstadt, Germany

and Goldenbergstr. 46 50374 Erftstadt,

Germany

(111) No. M/1727586

(180) 21/03/2033

(540) Madrid Registration

The logo for Belfone, featuring the word "Belfone" in a bold, black, sans-serif font. The letters "Belf" are in a standard weight, while "phone" is significantly larger and bolder. The text is set against a plain white background.

(511) 09

(210) No. M/1760533

(220) 12/10/2023

(732) Fujian Beifeng Telecom Technology Co., Ltd.

A-15 Huaqiao Economic Development Zone,

Shuangyang, Luojiang, Quanzhou Fujian,

China

(111) No. M/1760533

(180) 12/10/2033

(540) Madrid Registration

**FIBSHIELD**

(511) 01, 02, 03, 04 and 05

(210) No. M/1760534

(220) 12/10/2023

(732) Shenzhen Qianhai Tyrepair Industrial

Development Co., Ltd.

Room 201, Building A, No. 1, Qianhai 1st

Road, Qianhai Shenzhen-Hong Kong

Cooperation Zone, Shenzhen 518000

Guangdong, China

(111) No. M/1760534

(180) 12/10/2033

(540) Madrid Registration

**JOYOUS**

(511) 03, 04, 08, 10, 21, 25 and 26

(210) No. M/1761049

(220) 13/10/2023

(732) STAR RICH ENTERPRISE CO., LTD.

450/8 RAMA 3 ROAD, BANG KHLO SUB-

DISTRICT 10120 BANG KHO LAEM

DISTRICT, BANGKOK, THAILAND

(111) No. M/1761049

(180) 13/10/2033

(540) Madrid Registration

*Prairie Berry* 

(511) 03, 08, 10, 18, 21, 25 and 26

(210) No. M/1761410

(220) 13/10/2023

(732) Wingate Corporation Co., Ltd.

450/10 Rama 3 Road, Bang Khlo Sub-district  
10120 Bang Kho Laem District, Bangkok,  
Thailand

(111) No. M/1761410

(180) 13/10/2033

(540) Madrid Registration

*Pragon*   
*Blend*

(511) 34

(210) No. M/1761732

(220) 18/10/2023

(732) VENUS MANAGEMENT PTE. LTD.

111 NORTH BRIDGE ROAD, #21-03  
PENINSULA PLAZA SINGAPORE 179098

(111) No. M/1761732

(180) 18/10/2033

(540) Madrid Registration



(511) 20

(210) No. M/1762482

(220) 18/10/2023

(732) KIMNGUAN FURNITURE 2004

COMPANY LIMITED

129 MOO 5, TASAO SUB-DISTRICT 31000

HUAIRAT DISTRICT, BURIRAM,

THAILAND

(111) No. M/1762482

(180) 18/10/2033

(540) Madrid Registration



(511) 32

(210) No. M/1763228

(220) 19/10/2023

(732) Guangdong Pukou Food Co., Ltd.

F1, Office Building, No. 30 Huandao Road,

Shenwan Town, Zhongshan City Guangdong

Province, China

(111) No. M/1763228

(180) 19/10/2033

(540) Madrid Registration

**EV6 Water**

(511) 12

(210) No. M/1763790

(220) 27/10/2023

(732) Kia Corporation

12, Heolleung-ro, Seocho-gu Seoul 06797,

Republic of Korea

(111) No. M/1763790

(180) 27/10/2033

(540) Madrid Registration



**JUST WOKE UP<sup>®</sup>**  
**ENTREPRISES**



(511) 09, 25 and 41

(210) No. M/1764056

(220) 13/10/2023

(732) JUST WOKE UP SPRL

Rue Bara 175 B-1070 Bruxelles, Belgium

(111) No. M/1764056

(180) 13/10/2033



(540) Madrid Registration

The logo consists of the letters 'EVS' in a bold, stylized, italicized font, followed by the word 'Earth' in a standard serif font.

(511) 12

(210) No. M/1764109

(220) 27/10/2023

(732) Kia Corporation

12, Heolleung-ro, Seocho-gu Seoul 06797,

Republic of Korea

(111) No. M/1764109

(180) 27/10/2033

(540) Madrid Registration

The logo consists of the letters 'EVS' in a bold, stylized, italicized font, followed by the word 'Air' in a standard serif font.

(511) 12

(210) No. M/1764110

(220) 27/10/2023

(732) Kia Corporation

12, Heolleung-ro, Seocho-gu Seoul 06797,

Republic of Korea

(111) No. M/1764110

(180) 27/10/2033

(540) Madrid Registration

The logo for 'EVA Light' features the letters 'EVA' in a bold, stylized, black font. The 'E' and 'V' are connected, and the 'A' is also connected to the 'V'. To the right of 'EVA', the word 'Light' is written in a clean, black, sans-serif font.

(511) 12

(210) No. M/1764111

(220) 27/10/2023

(732) Kia Corporation

12, Heolleung-ro, Seocho-gu Seoul 06797,

Republic of Korea

(111) No. M/1764111

(180) 27/10/2033

(540) Madrid Registration



(511) 30 and 32

(210) No. M/1770598

(220) 13/10/2023

(732) Fonterra TM Limited

109 Fanshawe Street Auckland 1010,

New Zealand

(111) No. M/1770598

(180) 13/10/2033

(540) Madrid Registration



(511) 01, 05 and 29

(210) No. M/1706785

(220) 13/10/2023

(732) FONTERRA TM LIMITED

109 Fanshawe Street Auckland 1010,

New Zealand

(111) No. M/1706785

(180) 14/11/2032

(540) Madrid Registration

**WeDrink**

(511) 35

(210) No. M/1542609

(220) 12/09/2023

(732) ZHENGZHOU RUNXIANG CATERING  
MANAGEMENT CO., LTD.

Room 1906-1908, 19th Floor of Post

Building, No. 61 Zijingshan Road,

Guancheng District, Zhengzhou City Henan

Province, China

(111) No. M/1542609

(180) 27/05/2030

(540) Madrid Registration

**WeDrink**

(511) 30 and 32

(210) No. M/1543807

(220) 12/09/2023

(732) ZHENGZHOU RUNXIANG CATERING  
MANAGEMENT CO., LTD.

Room 1906-1908, 19th Floor of Post  
Building, No. 61 Zijingshan Road,  
Guancheng District, Zhengzhou City Henan  
Province, China

(111) No. M/1543807

(180) 06/07/2030

(540) Madrid Registration

**EJEAS**

(511) 09

(210) No. M/1740108

(220) 12/09/2023

(732) Shenzhen EJEAS Intelligent Technology Co.,  
Ltd.

Rm 3A, Bldg 1, No. 9, Zhongxin Rd.,  
Taoyuan Community, Dalang Subdist.,  
Longhua Dist., Shenzhen 518110  
Guangdong, China

(111) No. M/1740108

(180) 27/04/2033

(540) Madrid Registration

**Enigma**

(511) 33

(210) No. M/1758777

(220) 31/08/2023

(732) Enigma Wine Estates Pty Ltd

PO Box 252 FIGTREE NSW 2525,

AUSTRALIA

(111) No. M/1758777

(180) 31/08/2033

(540) Madrid Registration

**Neo QLED**

(511) 09

(210) No. M/1759628

(220) 01/09/2023

(732) Samsung Electronics Co., Ltd.

129, Samsung-ro, Yeongtong-gu Suwon-si,

Gyeonggi-do, Republic of Korea

(111) No. M/1759628

(180) 01/09/2033

(540) Madrid Registration

**MOINA**

(511) 03

(210) No. M/1760119

(220) 26/09/2023

(732) MOINA PTY LTD

Suite 201, 580 Collins Street Melbourne VIC

3000, Australia

(111) No. M/1760119

(180) 26/09/2033

(540) Madrid Registration

**MOR**

(511) 03

(210) No. M/1760121

(220) 26/09/2023

(732) MOR BOUTIQUE PTY LTD

Suite 201, 580 Collins Street Melbourne VIC

3000, Australia

(111) No. M/1760121

(180) 26/09/2033

(540) Madrid Registration



(511) 34

(210) No. M/1760291

(220) 01/09/2023

(732) SHEN ZHEN HUAFU TECHNOLOGY Co.,  
LTD

2703 Genzon Times Square Building, West  
Gate, No. 99, Longcheng Avenue, Shangjing  
Community, Longcheng Street, Longgang  
District, Shenzhen Guangdong Province,  
China

(111) No. M/1760291

(180) 01/09/2033

(540) Madrid Registration

**UYUSTOOLS**

(511) 07, 08, 09 and 11

(210) No. M/1760427

(220) 06/09/2023

(732) HANGZHOU HANTOO ENTERPRISES  
CO., LTD.

Building 4, No. 9 8th Xiyuan Road, Sandun  
Town, Xihu District, Hangzhou 310000  
Zhejiang, China

(111) No. M/1760427

(180) 06/09/2033

(540) Madrid Registration



(511) 35

(210) No. M/1760721

(220) 28/08/2023

(732) Shanghai Yoyao Intelligent New Energy

Automobile Sales Co., Ltd.

5th Floor, No. 277, Huqingping Road,

Minhang District Shanghai, China

(111) No. M/1760721

(180) 28/08/2033

(540) Madrid Registration

The letters 'AMX' in a bold, stylized, black font. The 'A' and 'M' are connected, and the 'X' is formed by two intersecting diagonal lines.

(511) 29

(210) No. M/1760722

(220) 24/08/2023

(732) INNER MONGOLIA YILI INDUSTRIAL

GROUP CO., LTD.

No.1 Jinshan Road, Jinshan Development

Zone, Hohhot 010110 Inner Mongolia

Autonomous Region, China

(111) No. M/1760722

(180) 24/08/2033



(540) Madrid Registration

**C&S SPECIAL**

(511) 03, 05, 16 and 24

(210) No. M/1760739

(220) 05/09/2023

(732) C&S PAPER CO., LTD.

No. 1 Longcheng Road, Dongsheng Town,

Zhongshan City Guangdong Province, China

(111) No. M/1760739

(180) 05/09/2033

(540) Madrid Registration

 **Eurotech**

(511) 06

(210) No. M/1761398

(220) 30/08/2023

(732) CONG TY CO PHAN TAP DOAN

EUROTECH

Km so 3+500, duong Nguyen Van Linh, to 1,

Phuong Thach Ban, Quan Long Bien Thanh

pho, Ha Noi, Vietnam

(111) No. M/1761398

(180) 30/08/2033

(540) Madrid Registration



(511) 32

(210) No. M/1761967

(220) 24/08/2023

(732) IPack B.V.

Cruquiusweg 98 W NL-1019 AJ Amsterdam,  
The Netherlands

(111) No. M/1761967

(180) 24/08/2033

(540) Madrid Registration

**Linxfour**

(511) 36

(210) No. M/1762557

(220) 04/10/2023

(732) linx4 GmbH

Eitzenbergerstraße 4-6/B06 A-2544  
Leobersdorf, Austria

(111) No. M/1762557

(180) 04/10/2033

(540) Madrid Registration



(511) 09

(210) No. M/1762692

(220) 25/08/2023

(732) INTERLINK COMMUNICATION PUBLIC  
COMPANY LIMITED

48 Interlink Building, Soi Rung-Reung,  
Ratchadapisek Road, Samsennok Sub-district  
Huay Khwang District, Bangkok 10310,  
Thailand

(111) No. M/1762692

(180) 25/08/2033

(540) Madrid Registration



(511) 20

(210) No. M/1762979

(220) 08/09/2023

(732) Chuangke Decoration New Materials (Hebei)  
Co., Ltd.

South of West Section, Zhenxing Road,  
Quzhou County, Handan City 057250 Hebei  
Province, China

(111) No. M/1762979

(180) 08/09/2033

(540) Madrid Registration

**MNCHIP**

(511) 10

(210) No. M/1762985

(220) 08/09/2023

(732) Tianjin MNCHIP Technologies Co.,Ltd.

F1-4 Section A Workshop, F1-2&4-5 of 3rd  
section of the office area, F5 of 2nd section of  
the office area, No, 122 Dongting Road  
Tianjin TEDA, China

(111) No. M/1762985

(180) 08/09/2033

(540) Madrid Registration

**BALODY**

(511) 28

(210) No. M/1763018

(220) 05/09/2023

(732) Shantou Liangao Toy Industry Co. LTD

Rongnan Road, Toufen village, Fengxiang  
Street, Chenghai, Shantou Guangdong, China

(111) No. M/1763018

(180) 05/09/2033

(540) Madrid Registration



(511) 10

(210) No. M/1763091

(220) 29/08/2023

(732) Shenzhen S-Hande Technology Co., Ltd.

2F, Building 8, Xinxintian Industrial Park,

Xinsha Road, Shajing Street, Baoan District,

Shenzhen City Guangdong Province, China

(111) No. M/1763091

(180) 29/08/2033

(540) Madrid Registration

**KAMTHAI**

(511) 09

(210) No. M/1763103

(220) 31/08/2023

(732) Lin Xiaobing

No. 216, chongbu 1st Road, Dongxing City,

Fangchenggang Guangxi Province, China

(111) No. M/1763103

(180) 31/08/2033

(540) Madrid Registration



(511) 07

(210) No. M/1763157

(220) 12/09/2023

(732) Yongkang Yishun Tools Co., Ltd.

No. 542 Huajin Road, Huajie Town,

Yongkang City, Jinhua City 321000 Zhejiang

Province, China

(111) No. M/1763157

(180) 12/09/2033

(540) Madrid Registration



(511) 03

(210) No. M/1763193

(220) 25/08/2023

(732) Guangzhou Suyin Trading Co., Ltd.

Rm 33, Rm 404, Bldg D, Guangzhou

Konggang Center, No. 1 Ivgang 3rd St,

Huadu Dist, Guangzhou, Guangdong Prov

China (Konggang Huadu), China

(111) No. M/1763193

(180) 25/08/2033

(540) Madrid Registration



(511) 19

(210) No. M/1763198

(220) 08/09/2023

(732) Chuangke Decoration New Materials (Hebei)  
Co., Ltd.

South of West Section, Zhenxing Road,

Quzhou County, Handan City 057250 Hebei

Province, China

(111) No. M/1763198

(180) 08/09/2033

(540) Madrid Registration



(511) 20

(210) No. M/1763210

(220) 08/09/2023

(732) Chuangke Decoration New Materials (Hebei)  
Co., Ltd.

South of West Section, Zhenxing Road,

Quzhou County, Handan City 057250 Hebei

Province, China

(111) No. M/1763210

(180) 08/09/2033

(540) Madrid Registration

**Hycomms**

(511) 06, 09 and 12

(210) No. M/1763212

(220) 06/09/2023

(732) Shenzhen Hycomms Communication Co.,  
Ltd.

Room 930, Sanhang Science and Technology  
Building, Northwestern Polytechnical  
University, No.45 Nanjiu Road, High-tech  
Zone, Yuehai Street Nanshan District,  
Shenzhen, China

(111) No. M/1763212

(180) 06/09/2033

(540) Madrid Registration

**DESO**

(511) 19

(210) No. M/1763216

(220) 06/09/2023

(732) ZHEJIANG DESO NEW BUILDING  
MATERIAL CO.,LTD

NO.121 JingSan Road, Economic  
Development Zone, Yueqing City 325600  
Zhejiang, China

(111) No. M/1763216

(180) 06/09/2033



(540) Madrid Registration

**HYMEY'S**

(511) 03

(210) No. M/1763229

(220) 21/08/2023

(732) Guangzhou Aisei Biotechnology Co., Ltd

(Airport Baiyun) 304, Block C, No. 13

Tongfu Road, Renhe Town, Baiyun District,

Guangzhou Guangdong Province, China

(111) No. M/1763229

(180) 21/08/2033

(540) Madrid Registration

**Filterpur**

(511) 11

(210) No. M/1763244

(220) 04/09/2023

(732) Foshan Qiding Environmental Protection

Technology Co., Ltd.

Room 801, Building 6, Haichuang Han's

Robot Intelligent Manufacturing Center, No. 3

Erzhi Industrial Avenue, Xihai Village, Beijiao

Town 528000 Shunde District, China

(111) No. M/1763244

(180) 04/09/2033

(540) Madrid Registration



(511) 29

(210) No. M/1763299

(220) 31/08/2023

(732) Sichuan Suining Nanda Food Co., Ltd.

No. 949, Yinhe South Road, Economic and  
Technological Development Zone, Suining  
City 629000 Sichuan, China

(111) No. M/1763299

(180) 31/08/2033

(540) Madrid Registration

**Solarwalker**

(511) 07

(210) No. M/1763504

(220) 12/09/2023

(732) Mamibot Manufacturing (Shanghai) Co., Ltd.

NORTH 21TH FLOOR, NO. 1 BUILDING,  
LN 1040 CAOYANG ROAD, PUTUO  
DISTRICT 200063 SHANGHAI, CHINA

(111) No. M/1763504

(180) 12/09/2033

(540) Madrid Registration

**Panelwalker**

(511) 07

(210) No. M/1763505

(220) 12/09/2023

(732) Mamibot Manufacturing (Shanghai) Co., Ltd.

NORTH 21TH FLOOR, NO. 1 BUILDING,

LN 1040 CAOYANG ROAD, PUTUO

DISTRICT 200063 SHANGHAI, CHINA

(111) No. M/1763505

(180) 12/09/2033

(540) Madrid Registration

**NSK**

(511) 04, 07, 12 and 37

(210) No. M/1007038

(220) 25/10/2022

(732) NSK Ltd.

6-3, Osaki 1-chome Shinagawa-ku, Tokyo

141-8560, Japan

(111) No. M/1007038

(180) 13/02/2029

(540) Madrid Registration

**OASIS**

(511) 01 and 17

(210) No. M/1594253

(220) 08/04/2021

(732) Smithers-Oasis Company

295 South Water Street, Suite 201 Kent OH

44240, United States of America

(111) No. M/1594253

(180) 08/04/2031

(540) Madrid Registration

 **CHENGSHAN**

(511) 12

(210) No. M/1692317

(220) 05/08/2022

(732) PRINX CHENGSHAN (SHANDONG) TIRE

COMPANY LTD.

NO.98 NANSHAN ROAD NORTH,

RONGCHENG CITY 264300 SHANDONG

PROVINCE, CHINA

(111) No. M/1692317

(180) 05/08/2032

(540) Madrid Registration

**Hedera**

(511)

(210) No. M/1720276

(220) 27/02/2023

(732) JIANGSU HANBON SCIENCE &  
TECHNOLOGY CO., LTD.

No. 1-9 Jixian Road and No. 10 Xinzhu Road,  
Economic Development Zone, Huai'An 223010  
Jiangsu, China

(111) No. M/1720276

(180) 27/02/2033

(540) Madrid Registration

**VURTUOSO**

(511) 05

(210) No. M/1300919

(220) 26/10/2023

(732) H. Lundbeck A/S

Ottiliavej 9 DK-2500 Valby, Denmark

(111) No. M/1300919

(180) 23/03/2026

(540) Madrid Registration

**PRUVYBO**

(511) 05

(210) No. M/1541830

(220) 30/10/2023

(732) CKD BiO Corporation

8, Chungjeong-ro, Seodaemun-gu Seoul,  
Republic of Korea

(111) No. M/1541830

(180) 03/06/2030

(540) Madrid Registration

**TQXIA**

(511) 05

(210) No. M/1546718

(220) 30/10/2023

(732) CKD BiO Corporation

8, Chungjeong-ro, Seodaemun-gu Seoul,  
Republic of Korea

(111) No. M/1546718

(180) 09/07/2030

(540) Madrid Registration

**TYEMVERS**

(511) 05

(210) No. M/1546741

(220) 30/10/2023

(732) CKD BiO Corporation

8, Chungjeong-ro, Seodaemun-gu Seoul,  
Republic of Korea

(111) No. M/1546741

(180) 09/07/2030

(540) Madrid Registration

**RQXO**

(511) 09

(210) No. M/1724117

(220) 31/10/2023

(732) QUAN ZHOU KAI LI ELECTRONICS CO.,  
LTD

Optoelectronic Information Industry Base,  
Xiamei Town, Nanan City 362300 Fujian  
Province, China

(111) No. M/1724117

(180) 16/01/2033

(540) Madrid Registration

**GAZER**

(511) 09 and 12

(210) No. M/1727261

(220) 26/05/2023

(732) Gazer Limited

17 Hanover Square London W1S 1BN,  
United Kingdom

(111) No. M/1727261

(180) 23/12/2032

(540) Madrid Registration

**CHALI**

(511) 29, 30, 32, 35 and 43

(210) No. M/1743269

(220) 19/10/2023

(732) GUANGZHOU CHALI GROUP CO., LTD.

No. A-2, Qunxin Road No. 22, Hengli  
Industrial Zone, Nansha District, Guangzhou  
City Guangdong Province, China

(111) No. M/1743269

(180) 02/03/2033



(540) Madrid Registration

**EXLANTIX**

(511) 37

(210) No. M/1748944

(220) 11/10/2023

(732) Chery Automobile Co., Ltd.

8 Changchun Road, Economy & Technology  
Development Zone, Wuhu City 241009  
Anhui Province, China

(111) No. M/1748944

(180) 29/06/2033

(540) Madrid Registration

 **VIPSHOP**

(511) 35

(210) No. M/1749512

(220) 11/10/2023

(732) VIPSHOP (China) Co., Ltd.

Building 6, No. 20 Huahai Avenue, Liwan  
District, Guangzhou Guangdong, China

(111) No. M/1749512

(180) 11/07/2033

(540) Madrid Registration



(511) 09, 28 and 41

(210) No. M/1764261

(220) 28/06/2023

(732) Euro Games Technology Ltd.

4, "Maritsa" Str., "Vranya-Lozen-

Triugulnika" BG-1151 Sofia, Bulgaria

(111) No. M/1764261

(180) 28/06/2033

(540) Madrid Registration



(511) 07, 09, 10, 12 and 42

(210) No. M/1764280

(220) 16/06/2023

(732) FAIR INNOVATION (Suzhou) ROBOT  
SYSTEM CO., LTD.

Room 1810 Building 2, No. 209 Zhuyuan

Road, New District, Suzhou 215000 Jiangsu,

China

(111) No. M/1764280

(180) 16/06/2033

(540) Madrid Registration

**ILUMA**

(511) 34

(210) No. M/1764390

(220) 12/10/2023

(732) Philip Morris Products S.A.

Quai Jeanrenaud 3 CH-2000 Neuchâtel,

Switzerland

(111) No. M/1764390

(180) 12/10/2033

(540) Madrid Registration

**Datik**

(511) 34

(210) No. M/1764567

(220) 24/10/2023

(732) VENUS MANAGEMENT PTE. LTD.

111 NORTH BRIDGE ROAD, #21-03

PENINSULA PLAZA SINGAPORE 179098

(111) No. M/1764567

(180) 24/10/2033

(540) Madrid Registration

**5 DAZZLING STAR**

(511) 09, 28 and 41

(210) No. M/1764569

(220) 30/06/2023

(732) Euro Games Technology Ltd.

4 Maritsa Street, Vrania-Lozen-Triugulnika,  
Pancharevo Region BG-1151 Sofia, Bulgaria

(111) No. M/1764569

(180) 30/06/2033

(540) Madrid Registration

**HONOR Notes**

(511) 09

(210) No. M/1764576

(220) 13/07/2023

(732) Honor Device Co., Ltd.

Suite 3401, Unit A, Building 6, Shum Yip  
Sky Park, No. 8089, Hongli West Road,  
Xiangmihu Street, Futian District, Shenzhen  
518040 Guangdong, China

(111) No. M/1764576

(180) 13/07/2033

(540) Madrid Registration



(511) 06, 07, 09, 11 and 12

(210) No. M/1764622

(220) 25/10/2023

(732) Helkama-Auto Oy

Lautamiehentie 3 FI-02770 Espoo, Finland

(111) No. M/1764622

(180) 25/10/2033

(540) Madrid Registration



(511) 09, 28 and 41

(210) No. M/1764701

(220) 28/06/2023

(732) Euro Games Technology Ltd.

4, "Maritsa" Str., "Vranya-Lozen-

Triugulnika" BG-1151 Sofia, Bulgaria

(111) No. M/1764701

(180) 28/06/2033

(540) Madrid Registration



(511) 09, 28 and 41

(210) No. M/1764733

(220) 28/06/2023

(732) Euro Games Technology Ltd.

4, "Maritsa" Str., "Vranya-Lozen-

Triugulnika" BG-1151 Sofia, Bulgaria

(111) No. M/1764733

(180) 28/06/2033

(540) Madrid Registration



(511) 09, 28 and 41

(210) No. M/1764734

(220) 28/06/2023

(732) Euro Games Technology Ltd.

6 Panorama Sofia Str., Richhill Business

Center, ground floor, Vitosha region

BG-1766 Sofia, Bulgaria

(111) No. M/1764734

(180) 28/06/2033

(540) Madrid Registration

**NEW COAST  
FORAGING  
COMPANY**

(511) 35

(210) No. M/1764753

(220) 12/07/2023

(732) Good Food Holdings, LLC

915 E 230th Street Carson CA 90745,

United States of America

(111) No. M/1764753

(180) 12/07/2033

(540) Madrid Registration

**FOREST BERRY  
CRUSH**

(511) 34

(210) No. M/1764821

(220) 10/11/2023

(732) Imperial Tobacco Limited

121 Winterstoke Road Bristol BS3 2LL,

United Kingdom

(111) No. M/1764821

(180) 10/11/2033

(540) Madrid Registration

**POLAR BERRY  
CRUSH**

(511) 34

(210) No. M/1764825

(220) 10/11/2023

(732) Imperial Tobacco Limited

121 Winterstoke Road Bristol BS3 2LL,

United Kingdom

(111) No. M/1764825

(180) 10/11/2033

(540) Madrid Registration

八子

(511) 05

(210) No. M/1764833

(220) 13/07/2023

(732) Shijiazhuang Yiling Pharmaceutical Co., Ltd

238, Tianshan Street, Hi-Tech Area,

Shijiazhuang Hebei Province, China

(111) No. M/1764833

(180) 13/07/2033



(540) Madrid Registration



(511) 05

(210) No. M/1764844

(220) 27/10/2023

(732) DeSouza International LLC

Suite #3, 1530 Pine Grove Ave. Port Huron

MI 48060, United States of America

(111) No. M/1764844

(180) 27/10/2033

(540) Madrid Registration

**OXITHION**

(511) 05

(210) No. M/1764949

(220) 26/07/2023

(732) NTC SRL

Via Luigi Razza 3 I-20124 Milano, Italy

(111) No. M/1764949

(180) 26/07/2033

(540) Madrid Registration

The logo for 'SHINING BOOM' features the word 'SHINING' in a yellow, blocky font with a slight shadow, and 'BOOM' in a larger, bold, yellow font with a red and orange gradient and a shadow effect.

(511) 09, 28 and 41

(210) No. M/1764955

(220) 28/06/2023

(732) Euro Games Technology Ltd.

6 Panorama Sofia Str., Richhill Business  
Center, ground floor, Vitosha region  
BG-1766 Sofia, Bulgaria

(111) No. M/1764955

(180) 28/06/2033

(540) Madrid Registration

The logo for 'Gift Spins' features the words 'Gift Spins' in a bold, black, serif font.

(511) 09, 28, 41 and 42

(210) No. M/1764980

(220) 22/06/2023

(732) EGT DIGITAL LTD.

6, "Panorama Sofia" Str., Business Center  
"Richhill", block A BG-1766 Sofia, Bulgaria

(111) No. M/1764980

(180) 22/06/2033

(540) Madrid Registration



(511) 03, 06, 07, 08, 09, 10, 11, 12, 14, 16, 17, 18,  
19, 20, 21, 22, 24, 25, 28, 32, 35, 37, 38, 42 and 43

(210) No. M/1764987

(220) 29/06/2023

(732) Foshan Alpicool Technology Co., LTD.

No. 38, the Pearl River Avenue, Bijiang

Industrial Zone, Bijiang Community, Beijiao

Town, Shunde District, Foshan City 528000

Guangdong Province, China

(111) No. M/1764987

(180) 29/06/2033

(540) Madrid Registration

**SKPEARLNEST**

(511) 29, 30 and 32

(210) No. M/1765087

(220) 31/08/2023

(732) KHANH HOA SANEST SOFT DRINK

JOINT STOCK COMPANY

National Highway 1A, My Thanh Village,

Cam Thinh Dong Commune, Cam Ranh City

Khanh Hoa Province, Vietnam

(111) No. M/1765087

(180) 31/08/2033

(540) Madrid Registration



(511) 12

(210) No. M/1765279

(220) 07/08/2023

(732) HO KHAC HUNG

Number 3A, Room 6, Group 16, Chuong  
Duong Ward, Hoan Kiem District Hanoi,  
Vietnam

(111) No. M/1765279

(180) 07/08/2033

(540) Madrid Registration



(511) 11

(210) No. M/1765326

(220) 29/08/2023

(732) Shenzhen Kuangxiang Technology Co., Ltd.

807, No.51, Pingxin North Road, Shangmugu  
Community, Pinghu Street, Longgang  
District, Shenzhen Guangdong Province,  
China

(111) No. M/1765326

(180) 29/08/2033

(540) Madrid Registration

The logo for MulinSen is written in a black, cursive, handwritten-style font.

(511) 25

(210) No. M/1765343

(220) 20/10/2023

(732) Fujian Shishi City Fusheng Shoes Industry  
Co., Ltd.

No. 58 Changlin West Road, Hubin Street,  
Shishi City, Quanzhou City 362000 Fujian  
Province, China

(111) No. M/1765343

(180) 20/10/2033

(540) Madrid Registration

The logo for SUPREME COMBO LINK features the word "SUPREME" in a bold, yellow, 3D-style font above the words "COMBO LINK" in a bold, red, 3D-style font.

(511) 09, 28 and 41

(210) No. M/1765349

(220) 28/06/2023

(732) Euro Games Technology Ltd.

4, "Maritsa" Str., "Vranya-Lozen-  
Triugulnika" BG-1151 Sofia, Bulgaria

(111) No. M/1765349

(180) 28/06/2033

(540) Madrid Registration



(511) 28

(210) No. M/1765360

(220) 25/08/2023

(732) Shantoushi Chenghaiqu Wensheng Plastic  
Toys Industry Co., Ltd.  
Donghu Industrial Zone, Fengxiang Street,  
Chenghai District, Shantou City 515800  
Guangdong Province, China

(111) No. M/1765360

(180) 25/08/2033

(540) Madrid Registration



(511) 29

(210) No. M/1765427

(220) 25/10/2023

(732) Shandong Qiteng Biotechnology Co., Ltd  
No. 999, North Yikang Avenue, Tengzhou  
Economic Development Zone, Zaozhuang  
Shandong, China

(111) No. M/1765427

(180) 25/10/2033

(540) Madrid Registration

## HONOR Docs

(511) 09

(210) No. M/1765443

(220) 10/10/2023

(732) Honor Device Co., Ltd.

Suite 3401, Unit A, Building 6, Shum Yip Sky  
Park, No. 8089, Hongli West Road, Xiangmihu  
Street, Futian District, Shenzhen 518040  
Guangdong, China

(111) No. M/1765443

(180) 10/10/2033

(540) Madrid Registration

## Formula Bao

(511) 12 and 37

(210) No. M/1765451

(220) 28/09/2023

(732) BYD COMPANY LIMITED

No.1, Yan'an Road, Kuichong Street, Dapeng  
New District, Shenzhen Guangdong, China

(111) No. M/1765451

(180) 28/09/2033

(540) Madrid Registration



(511) 41

(210) No. M/1765485

(220) 31/07/2023

(732) Chengdu Shangpai Cultural Media Co., Ltd  
Room 1805, 18th Floor, Unit 1, Building 6,  
No. 1700, Tianfu Avenue North Section,  
Chengdu High tech Zone (Sichuan) Pilot Free  
Trade Zone, China

(111) No. M/1765485

(180) 31/07/2033

(540) Madrid Registration



(511) 21

(210) No. M/1765504

(220) 23/10/2023

(732) FOSHAN HUAXING THERMOS CO., LTD  
No. 41, Baiye Rd., Xiqiao Industrial Zone,  
Nanhai, Foshan 528200 Guangdong, China

(111) No. M/1765504

(180) 23/10/2033



(540) Madrid Registration

**DIRECT ATTACHED**

(511) 09

(210) No. M/1765605

(220) 19/10/2023

(732) Amphenol Commercial Products (Chengdu)

Co., Ltd

Suite D3, Molding Tool Industrial Park

West District of Chengdu Tech Zone 611731

Chengdu, Sichuan, China

(111) No. M/1765605

(180) 19/10/2033

(540) Madrid Registration

**MindGPT**

(511) 09, 35, 41 and 42

(210) No. M/1765622

(220) 15/09/2023

(732) Beijing Chj Information Technology Co., Ltd.

Room 101, Building 1 No. 4 Hengxing Road,

Gaoliying Shunyi District, (Technological

Innovation Industry Functional Zone) 101300

Beijing, China

(111) No. M/1765622

(180) 15/09/2033

(540) Madrid Registration



(511) 09

(210) No. M/1765686

(220) 13/10/2023

(732) QINGDAO THUNDERBOT  
TECHNOLOGY CO., LTD.

No. 1 Haier Road, Laoshan District, Qingdao  
City Shandong Province, China

(111) No. M/1765686

(180) 13/10/2033

(540) Madrid Registration



(511) 12 and 37

(210) No. M/1765693

(220) 13/10/2023

(732) Chery Automobile Co., Ltd.

8 Changchun Road, Economy & Technology  
Development Zone, Wuhu City 241009  
Anhui Province, China

(111) No. M/1765693

(180) 13/10/2033

(540) Madrid Registration



(511) 09, 28 and 41

(210) No. M/1765728

(220) 28/06/2023

(732) Euro Games Technology Ltd.

4, "Maritsa" Str., "Vranya-Lozen-

Triugulnika" BG-1151 Sofia, Bulgaria

(111) No. M/1765728

(180) 28/06/2033

(540) Madrid Registration

***CARBONSONIC***

(511) 28

(210) No. M/1765732

(220) 19/06/2023

(732) VICTOR RACKETS INDUSTRIAL CORP.

No. 3-2, Lane 67, Sec. 3, Nangang Rd.,

Nangang Dist., Taipei 115004 Taiwan, China

(111) No. M/1765732

(180) 19/06/2033

(540) Madrid Registration

**E11EVEN BEACH**

(511) 25 and 28

(210) No. M/1765765

(220) 01/11/2023

(732) GR OPCO, LLC

29 N.E. 11th Street Miami FL 33132,

United States of America

(111) No. M/1765765

(180) 01/11/2033

(540) Madrid Registration

**KWS康巴仕**

(511) 10

(210) No. M/1765809

(220) 09/08/2023

(732) Hebei Kangweishi Medical Technology Co.,  
Ltd

South of Koucun Village (South District of

Hebei Yuanshi Economic Development

Zone), Yuanshi County, Shijiazhuang City

050000 Hebei Province, China

(111) No. M/1765809

(180) 09/08/2033

(540) Madrid Registration

**SHAIDEN ROGUE**

(511) 41

(210) No. M/1765813

(220) 23/08/2023

(732) U.D.P. UNREAL DIGITAL PAIN LTD

LORDOU VYRONOS 61-63 CY-6023

LARNACA, CYPRUS

(111) No. M/1765813

(180) 23/08/2033

(540) Madrid Registration



(511) 34

(210) No. M/1765848

(220) 18/10/2023

(732) Philip Morris Products S.A.

Quai Jeanrenaud 3 CH-2000 Neuchâtel,

Switzerland

(111) No. M/1765848

(180) 18/10/2033

(540) Madrid Registration

**TEREA**

(511) 34

(210) No. M/1765887

(220) 19/10/2023

(732) Philip Morris Products S.A.

Quai Jeanrenaud 3 CH-2000 Neuchâtel,

Switzerland

(111) No. M/1765887

(180) 19/10/2033

(540) Madrid Registration

**Mighty Heracle**

(511) 09, 28 and 41

(210) No. M/1766098

(220) 13/07/2023

(732) Euro Games Technology Ltd.

6 Panorama Sofia Str., Richhill Business

Center, ground floor, Vitosha region BG-1766

Sofia, Bulgaria

(111) No. M/1766098

(180) 13/07/2033

(540) Madrid Registration



(511) 01, 07 and 42

(210) No. M/1766433

(220) 28/06/2023

(732) BGRIMM Technology Group

No.1 Wenxing Street, Xiwai, Xicheng

District 100044 Beijing, China

(111) No. M/1766433

(180) 28/06/2033

(540) Madrid Registration



(511) 21 and 35

(210) No. M/1766613

(220) 19/12/2022

(732) Commerce Enterprises Pty. Ltd.

5 Goulburn Street Sydney NSW 2148,

Australia

(111) No. M/1766613

(180) 19/12/2032

(540) Madrid Registration

**Johnson&Johnson**

(511) 05, 09, 10, 16, 41, 42 and 44

(210) No. M/1766672

(220) 25/09/2023

(732) Johnson & Johnson

One Johnson & Johnson Plaza New  
Brunswick NJ 08933,  
United States of America

(111) No. M/1766672

(180) 25/09/2033

(540) Madrid Registration

**Vigor Doctor**

(511) 03 and 21

(210) No. M/1766850

(220) 03/08/2023

(732) Zhang Gan

No. H3-26781 Yiwu International Trade Mart  
Zhejiang, China

(111) No. M/1766850

(180) 03/08/2033



(540) Madrid Registration



(511) 05, 09, 10, 16, 41, 42 and 44

(210) No. M/1766867

(220) 25/09/2023

(732) Johnson & Johnson

One Johnson & Johnson Plaza New

Brunswick NJ 08933,

United States of America

(111) No. M/1766867

(180) 25/09/2033

(540) Madrid Registration

**FORTUNE NUMBER**

(511) 28 and 41

(210) No. M/1766910

(220) 10/11/2023

(732) INTERBLOCK D.O.O.

6900 S Decatur Boulevard, Suite 100 Las

Vegas NV 89118, United States of America

(111) No. M/1766910

(180) 10/11/2033

(540) Madrid Registration

**PARDO**

(511) 01

(210) No. M/1766924

(220) 04/07/2023

(732) JINXING WANG

Room 602, Building 14, Shunde Yajule  
Garden, No.22 Yannian Road, Daliang Street,  
Shunde District, Foshan City 528000  
Guangdong Province, China

(111) No. M/1766924

(180) 04/07/2033

(540) Madrid Registration

**milk\_shake**

(511) 03 and 35

(210) No. M/1766982

(220) 26/06/2023

(732) Z.ONE CONCEPT S.R.L.

Via Brodolini 30 I-21046 MALNATE (VA),  
ITALY

(111) No. M/1766982

(180) 26/06/2033

(540) Madrid Registration



(511) 01

(210) No. M/1767016

(220) 12/07/2023

(732) GUANGDONG MANCANDO

INFORMATION TECHNOLOGY CO.,  
LTD.

Floor 22 (Whole Floor), Vanke Sanyuanli

Center, No. 31, Airport Road, Baiyun District,

Guangzhou City 510080 Guangdong

Province, China

(111) No. M/1767016

(180) 12/07/2033

(540) Madrid Registration



(511) 04

(210) No. M/1767017

(220) 12/07/2023

(732) GUANGDONG MANCANDO

INFORMATION TECHNOLOGY CO.,  
LTD.

Floor 22 (Whole Floor), Vanke Sanyuanli

Center, No. 31, Airport Road, Baiyun District,

Guangzhou City 510080 Guangdong

Province, China

(111) No. M/1767017

(180) 12/07/2033

(540) Madrid Registration

The logo for SPACEPAH SYSTEM features the word "SPACEPAH" in a stylized, outlined font above the word "SYSTEM" in a similar but smaller font.

(511) 18

(210) No. M/1767072

(220) 18/09/2023

(732) FLIGHT 001 ASIA LIMITED

FLAT B, 77TH FLOOR, SHING HING

COMMERCIAL BLDG., 21-27 WING KUT

ST. CENTRAL HONG KONG, CHINA

(111) No. M/1767072

(180) 18/09/2033

(540) Madrid Registration

The logo for HERMES FORTUNES features the word "HERMES" in a large, stylized font above the word "FORTUNES" in a similar font. The letters are filled with a gradient and have a glowing effect.

(511) 09, 28, 41 and 42

(210) No. M/1767125

(220) 22/06/2023

(732) EGT DIGITAL LTD.

6, "Panorama Sofia" Str., Business Center

"Richhill", block A BG-1766 Sofia, Bulgaria

(111) No. M/1767125

(180) 22/06/2033

(540) Madrid Registration

**SPRIX**

(511) 09, 16 and 41

(210) No. M/1767190

(220) 23/10/2023

(732) SPRIX Inc.

2-2-1, Higashisakanouemachi, Nagaoka-shi

Niigata 940-0066, Japan

(111) No. M/1767190

(180) 23/10/2033

(540) Madrid Registration

**RSILOU**

(511) 09

(210) No. M/1767192

(220) 28/06/2023

(732) Guangzhou Onda Information Technology

Co., LTD

Room 1010 (Office only), No. 89 of Yanling

Road, Tianhe District, Guangzhou City

510000 Guangdong Province, China

(111) No. M/1767192

(180) 28/06/2033

(540) Madrid Registration

**COMBS**

(511) 25

(210) No. M/1767229

(220) 28/11/2023

(732) GFM GmbH Trademarks

An der Ach 3 82402 Seeshaupt, Germany

(111) No. M/1767229

(180) 28/11/2033

(540) Madrid Registration

**DESERT WEALTH**

(511) 09, 28 and 41

(210) No. M/1767305

(220) 28/06/2023

(732) Euro Games Technology Ltd.

4, "Maritsa" Str., "Vranya-Lozen-

Triugulnika" BG-1151 Sofia, Bulgaria

(111) No. M/1767305

(180) 28/06/2033

(540) Madrid Registration



(511) 09

(210) No. M/1767334

(220) 22/09/2023

(732) Apple Inc.

One Apple Park Way Cupertino CA 95014,  
United States of America

(111) No. M/1767334

(180) 22/09/2033

(540) Madrid Registration

**YUMSHARE**

(511) 21

(210) No. M/1767412

(220) 18/07/2023

(732) PETKIT Network Technology (Shanghai)

Co., Ltd.

Room 4139, Building 2, No. 588, Zixing  
Road, Minhang District 201100 Shanghai,  
China

(111) No. M/1767412

(180) 18/07/2033

(540) Madrid Registration

**SIGHTFUTURE**

(511) 03

(210) No. M/1767414

(220) 08/08/2023

(732) GUANGZHOU UNIASIA COSMETIC  
TECHNOLOGY CO., LTD.

No. 15 Kelin Road, Guangzhou Science City,  
Guangzhou City Guangdong Province, China

(111) No. M/1767414

(180) 08/08/2033

(540) Madrid Registration



(511) 43

(210) No. M/1767586

(220) 22/11/2023

(732) GAFA FINANZIARIA SRL

Via Bassano del Grappa n. 24 I-00195  
ROMA, Italy

(111) No. M/1767586

(180) 22/11/2033



(540) Madrid Registration

The logo for KEEPIZT is displayed in a bold, black, sans-serif font. The letters are spaced out, and the 'E's have a unique, slightly irregular shape.

(511) 16 and 21

(210) No. M/1767623

(220) 03/08/2023

(732) Neutrovis Sdn Bhd

Block C, PJ City Development, 15A, Jalan  
51a/219, Seksyen 51a, 46100 Petaling Jaya  
Selangor, Malaysia

(111) No. M/1767623

(180) 03/08/2033

(540) Madrid Registration

The logo for BGX is displayed in a bold, red, sans-serif font. The letters are spaced out, and the 'G' has a unique, slightly irregular shape.

(511) 07, 08, 09 and 11

(210) No. M/1767714

(220) 28/07/2023

(732) Nanjing BGX Machinery and Equipment Co.,  
Ltd.

Room 302, No. 301, Hanzhongmen Street,  
Gulou District, Nanjing City 210000 Jiangsu  
Province, China

(111) No. M/1767714

(180) 28/07/2033

(540) Madrid Registration

**KEEP·Y**

(511) 03

(210) No. M/1768391

(220) 15/08/2023

(732) GUANGZHOU UNIASIA COSMETIC  
TECHNOLOGY CO., LTD.

No. 15 Kelin Road, Guangzhou Science City,  
Guangzhou City Guangdong Province, China

(111) No. M/1768391

(180) 15/08/2033

(540) Madrid Registration

**GUUD**

(511) 05, 09, 10 and 44

(210) No. M/1768623

(220) 03/04/2023

(732) FERNANDO GARCIA SADA

CALZADA DEL VALLE NUM. EXT. 202,  
NUM. INT. PISO 3, COLONIA DEL  
VALLE 66220 MONTERREY, NUEVO  
LEON, MEXICO

(111) No. M/1768623

(180) 03/04/2033

(540) Madrid Registration



(511) 03 and 05

(210) No. M/1768653

(220) 11/08/2023

(732) THAI HERBAL HONGTHAI CO., LTD.

434 Phutthamonthon Sai2 RD, Bang Phai

Sub-district 10160 Bang Kae District,

Bangkok, Thailand

(111) No. M/1768653

(180) 11/08/2033

(540) Madrid Registration



(511) 30

(210) No. M/1768668

(220) 24/08/2023

(732) THANDEE INNOFOOD CO., LTD.

4 Soi Phetkasem 110/1, Phetkasem Road,

Nong Khang Phlu Sub-district 10160 Nong

Khaem District, Bangkok, Thailand

(111) No. M/1768668

(180) 24/08/2033

(540) Madrid Registration



谷瀑  
GOEPE.COM

(511) 35 and 42

(210) No. M/1768839

(220) 08/08/2023

(732) HANGZHOU VALLEY WATERFALL  
INFORMATION TECHNOLOGY CO.,  
LTD.

Room 917-920, Bldg. 2, No. 515, No. 2  
Avenue, Baiyang Sub-district, Qiantang  
District, Hangzhou City, Pilot Free Trade  
Zone Zhejiang Province, China

(111) No. M/1768839

(180) 08/08/2033

(540) Madrid Registration



chw!st

(511) 30

(210) No. M/1768858

(220) 21/08/2023

(732) VT SWEET & FOOD INNOTECH  
COMPANY LIMITED

38/8 Moo 5, Pak Nam Sub-district 24110  
Bang Khla District, Chachoengsao, Thailand

(111) No. M/1768858

(180) 21/08/2033

(540) Madrid Registration

**SOLVENTUM**

(511) 03, 05, 09, 10, 11, 35, 41, 42 and 44

(210) No. M/1768980

(220) 18/08/2023

(732) Solventum Intellectual Properties Company

3M Center, Building 275 2510 Conway

Avenue East Maplewood MN 55144,

United States of America

(111) No. M/1768980

(180) 18/08/2033

(540) Madrid Registration

**REYTEN**

(511) 11

(210) No. M/1768981

(220) 30/06/2023

(732) General Climate DOO Novi Sad

Novi Sad, Zheleznichka 13, Serbia

(111) No. M/1768981

(180) 30/06/2033

(540) Madrid Registration

**ULTRAMAN**

(511) 09, 16, 25, 28 and 41

(210) No. M/1769029

(220) 31/10/2023

(732) Tsuburaya Productions Co., Ltd.

16-17 Nampeidai-cho, Shibuya-ku Tokyo

150-0036, Japan

(111) No. M/1769029

(180) 31/10/2033

(540) Madrid Registration

**POLLEY**

(511) 25

(210) No. M/1769131

(220) 05/12/2023

(732) GFM GmbH Trademarks

An der Ach 3 82402 Seeshaupt, Germany

(111) No. M/1769131

(180) 05/12/2033

(540) Madrid Registration



(511) 29 and 30

(210) No. M/1769140

(220) 22/06/2023

(732) Société des Produits Nestlé S.A.

CH-1800 Vevey, Switzerland

(111) No. M/1769140

(180) 22/06/2033

(540) Madrid Registration

**GARNER AN IHG  
HOTEL**

(511) 35 and 43

(210) No. M/1769338

(220) 16/08/2023

(732) Six Continents Limited

1 Windsor Dials, Arthur Road Windsor,

Berkshire SL4 1RS, United Kingdom

(111) No. M/1769338

(180) 16/08/2033

(540) Madrid Registration



(511) 07, 09, 11 and 12

(210) No. M/1769394

(220) 24/08/2023

(732) SHENZHEN INVT ELECTRIC CO., LTD.

501, Building A7, Nanshan Zhiyuan, No.

1001 Xueyuan Avenue, Changyuan

Community, Taoyuan Subdistrict, Nanshan

District 518000 Shenzhen, China

(111) No. M/1769394

(180) 24/08/2033

(540) Madrid Registration



(511) 30 and 43

(210) No. M/1769436

(220) 05/09/2023

(732) TRUNG NGUYEN INVESTMENT

CORPORATION

82-84 Bui Thi Xuan Street, Ben Thanh Ward,

District 1 Ho Chi Minh City, Vietnam

(111) No. M/1769436

(180) 05/09/2033



(540) Madrid Registration



(511) 11

(210) No. M/1048748

(220) 30/11/2023

(732) Guangzhou Monalisa Building Materials  
Company Limited and Guangzhou Monalisa  
Sanitary Ware Co., Ltd.

Room 201, B Building, No. 4 Beixing  
Gangtou Industrial Area, Huadong Town,  
Huadu District, Guangzhou City Guangdong  
Province, China and Room 201, B Building,  
No. 4 Beixing Gangtou Industrial Area,  
Huadong Town, Huadu District, Guangzhou  
City Guangdong Province, China

(111) No. M/1048748

(180) 29/06/2030

(540) Madrid Registration

**LION OF PORCHES**

(511) 18 and 25

(210) No. M/1108183

(220) 22/11/2023

(732) TÊXTIL CÃES DE PEDRA, S.A.

Avenida 1º de Maio, 1666 P-4485-105 Fajozes,  
Portugal

(111) No. M/1108183

(180) 13/01/2032

(540) Madrid Registration

**GvW**

(511) 35, 36 and 45

(210) No. M/1151670

(220) 17/11/2023

(732) Graf von Westphalen, Rechtsanwälte

Ulmenstr. 23-25 60325 Frankfurt am Main,  
Germany

(111) No. M/1151670

(180) 21/12/2032

(540) Madrid Registration

**Winmax**

(511) 12

(210) No. M/1189005

(220) 21/11/2023

(732) KASHIYAMA SHOUTEN

3830 Iwamura, Saku-city Nagano-pref.  
385-0022, Japan

(111) No. M/1189005

(180) 29/10/2033

(540) Madrid Registration

**WellO2**

(511) 05, 10 and 11

(210) No. M/1192403

(220) 02/11/2023

(732) WellO2 Oy

Verstaankatu 5 A 3 Tampere, Finland

(111) No. M/1192403

(180) 18/09/2033

(540) Madrid Registration

**CONFIDIAN**

(511) 01 and 05

(210) No. M/1414607

(220) 06/11/2023

(732) Roche Diagnostics GmbH

Sandhofer Strasse 116 68305 Mannheim,

Germany

(111) No. M/1414607

(180) 01/06/2028

(540) Madrid Registration

**ITOVEBI**

(511) 05

(210) No. M/1574451

(220) 30/11/2023

(732) F. Hoffmann-La Roche AG

Grenzacherstrasse 124 CH-4070 Basel,

Switzerland

(111) No. M/1574451

(180) 11/12/2030

(540) Madrid Registration

**CERAMIC SHIELD**

(511) 09

(210) No. M/1591148

(220) 01/12/2023

(732) Apple Inc.

One Apple Park Way Cupertino CA 95014,

United States of America

(111) No. M/1591148

(180) 05/03/2031

(540) Madrid Registration

**[yellow tail]**

(511) 33

(210) No. M/1613478

(220) 28/11/2023

(732) Casella Wines Pty Limited

Farm 1471 Wakley Rd YENDA NSW 2681,  
Australia

(111) No. M/1613478

(180) 22/07/2031

(540) Madrid Registration

**THE PINK STUFF**

(511) 03

(210) No. M/1655131

(220) 24/11/2023

(732) Star Brands Limited

Suite 1, 1175 Century Way, Thorpe Park  
Leeds, West Yorkshire LS15 8ZB,  
United Kingdom

(111) No. M/1655131

(180) 07/01/2032

(540) Madrid Registration

The logo for LEVITA features the word "LEVITA" in a bold, black, sans-serif font. A horizontal yellow line is drawn across the middle of the letters, passing through the center of each letter.

(511) 41

(210) No. M/1666769

(220) 01/11/2023

(732) LEVITA FZCO

Dubai Silicon Oasis, IFZA Properties

DSO-FZA-21844, United Arab Emirates

(111) No. M/1666769

(180) 29/12/2031

(540) Madrid Registration



(511) 09, 36 and 38

(210) No. M/1717979

(220) 22/11/2023

(732) Kakao Corp.

242, Cheomdan-ro, Jeju-si Jeju-do,

Republic of Korea

(111) No. M/1717979

(180) 01/12/2032

(540) Madrid Registration

**KakaoPay**

(511) 09, 36 and 38

(210) No. M/1720785

(220) 27/11/2023

(732) Kakao Corp.

242, Cheomdan-ro, Jeju-si Jeju-do,  
Republic of Korea

(111) No. M/1720785

(180) 29/11/2032

(540) Madrid Registration

**OnePlus Open**

(511) 09

(210) No. M/1760515

(220) 15/11/2023

(732) OnePlus Technology (Shenzhen) Co., Ltd.

18C02, 18C03, 18C04, and 18C05, Shum Yip  
Terra Building, Binhe Avenue North, Futian  
District, Shenzhen Guangdong, China

(111) No. M/1760515

(180) 15/08/2033

(540) Madrid Registration

**WRITECH**

(511) 16

(210) No. M/1765129

(220) 03/11/2023

(732) WRITECH, INC

92 CORPORATE PARK STE C 204 IRVINE

CA 92606, UNITED STATES OF AMERICA

(111) No. M/1765129

(180) 03/11/2033

(540) Madrid Registration

 **Supeni**

(511) 06

(210) No. M/1765474

(220) 10/11/2023

(732) Guangdong Supeni Home Technology Co.,  
Ltd

Workshop 19-3, Yongxing Street (N), Hu  
Village Development Zone, Shadun, Liansha,  
Danzao Town, Nanhai District, Foshan City  
528000 Guangdong Province, China

(111) No. M/1765474

(180) 10/11/2033



(540) Madrid Registration



(511) 09

(210) No. M/1765671

(220) 02/11/2023

(732) Cai Qisheng

Tutou Village, Jinggu Township, Ruian City

Zhejiang Province, China

(111) No. M/1765671

(180) 02/11/2033

(540) Madrid Registration

**EYALTA**

(511) 05

(210) No. M/1765984

(220) 15/11/2023

(732) Vyluma Inc.

1019 US Highway 202-206 Bridgewater NJ

08807, United States of America

(111) No. M/1765984

(180) 15/11/2033

(540) Madrid Registration



(511) 09

(210) No. M/1766524

(220) 02/11/2023

(732) Interlink Communication Public Co., Ltd.

48 Interlink Building, Soi Rung-Reung,

Ratchadapisek Road, Samsennok, Huay

Khwang District 10310 Bangkok, Thailand

(111) No. M/1766524

(180) 02/11/2033

(540) Madrid Registration

**SHEIN**

(511) 25 and 35

(210) No. M/1767074

(220) 17/11/2023

(732) Roadget Business Pte. Ltd.

12 Marina Boulevard, #15-01, Marina Bay

Financial Centre Singapore 018982,

Singapore

(111) No. M/1767074

(180) 17/11/2033

(540) Madrid Registration

**DR.TWENTYPROJECT**

(511) 03

(210) No. M/1767159

(220) 20/11/2023

(732) GP CLUB CO., LTD

GP CLUB Bldg., 152, Wonhyo-ro,

Yongsan-gu Seoul, Republic of Korea

(111) No. M/1767159

(180) 20/11/2033

(540) Madrid Registration

**NEOFLAM**

(511) 21

(210) No. M/1769014

(220) 21/11/2023

(732) NEOFLAM Inc.

1, Gieopdosi-ro, Jijeong-myeon, Wonju-si

Gangwon-do, Republic of Korea

(111) No. M/1769014

(180) 21/11/2033

(540) Madrid Registration

**ELIE BLEU**

(511) 14, 20 and 34

(210) No. M/0484216

(220) 28/03/2024

(732) EBI, société anonyme

48 rue du Bac F-75007 Paris, France

(111) No. M/0484216

(180) 27/03/2034

(540) Madrid Registration



(511) 43

(210) No. M/1109915

(220) 01/12/2023

(732) PURA BRASA WORLD, S.L.

Montpalau, 1-3 Pineda de Mar (Barcelona),  
Spain

(111) No. M/1109915

(180) 05/01/2032

(540) Madrid Registration



(511) 09, 16, 35 and 41

(210) No. M/1197335

(220) 11/06/2020

(732) The British Council

1 Redman Place, Stratford London E20 1JQ,  
United Kingdom

(111) No. M/1197335

(180) 30/12/2033

(540) Madrid Registration

**KODIAQ**

(511) 12

(210) No. M/1303284

(220) 13/12/2023

(732) ŠKODA AUTO a.s.

tě. Václava Klementa 869, Mladá Boleslav II  
CZ-293 01 Mladá Boleslav, Czech Republic

(111) No. M/1303284

(180) 18/11/2025

(540) Madrid Registration



(511) 09, 12, 35, 36, 37 and 39

(210) No. M/1462320

(220) 13/08/2018

(732) ECOTEK CANADA PROMOTION TRADE  
CORPORATION

1188 West Georgia Street, Unit 1440

Vancouver BC V6E 4A2, Canada

(111) No. M/1462320

(180) 13/08/2028

(540) Madrid Registration

**ENYAQ**

(511) 12

(210) No. M/1480395

(220) 13/12/2023

(732) ŠKODA AUTO a.s.

tř. Václava Klementa 869 CZ-293 01 Mladá

Boleslav, Mladá Boleslav II, Czech Republic

(111) No. M/1480395

(180) 11/04/2029

(540) Madrid Registration

**20 BURNING DICE**

(511) 09, 28 and 41

(210) No. M/1487417

(220) 10/05/2019

(732) Euro Games Technology Ltd.

"Maritsa" Str., 4, „Vranya-Lozen-

Triugulnika" BG-1151 Sofia, Bulgaria

(111) No. M/1487417

(180) 10/05/2029

(540) Madrid Registration

**CHERIGAN**

(511) 03

(210) No. M/1527022

(220) 12/12/2023

(732) Luc GABRIEL and THE DIFFERENT

COMPANY

88, rue de l'Université F-75007 PARIS, France

and 37 rue Louise WEISS F-75013 PARIS,

France

(111) No. M/1527022

(180) 17/03/2030

(540) Madrid Registration

**POST-IT**

(511) 09 and 16

(210) No. M/1530682

(220) 10/03/2020

(732) 3M Company

3M Center, 2501 Hudson Road St. Paul MN

55144, United States of America

(111) No. M/1530682

(180) 10/03/2030

(540) Madrid Registration

**THE EMPIRE BRUNEI**

(511) 43

(210) No. M/1532572

(220) 14/04/2020

(732) JPH SENDIRIAN BERHAD

Muara-Tutong Highway Jerudong BG-3122,

Brunei Darussalam

(111) No. M/1532572

(180) 14/04/2030



(540) Madrid Registration



(511) 12

(210) No. M/1535917

(220) 15/05/2020

(732) HANKOOK & COMPANY CO., LTD.

286, Pangyo-ro, Bundang-gu, Seongnam-si

Gyeonggi-do, Republic of Korea

(111) No. M/1535917

(180) 15/05/2030

(540) Madrid Registration



(511) 35, 38 and 41

(210) No. M/1539941

(220) 25/03/2020

(732) CHINA INTERNATIONAL IMPORT EXPO

BUREAU

No.168, Yinggang East Road, Qingpu District

100031 Shanghai City, China

(111) No. M/1539941

(180) 25/03/2030

(540) Madrid Registration



(511) 09, 28 and 41

(210) No. M/1550673

(220) 29/05/2020

(732) Euro Games Technology Ltd.

4, "Maritsa" Str., "Vranya-Lozen-

Triugulnika" BG-1151 Sofia, Bulgaria

(111) No. M/1550673

(180) 29/05/2030

(540) Madrid Registration



(511) 09, 28 and 41

(210) No. M/1550785

(220) 02/06/2020

(732) Euro Games Technology Ltd.

4, "Maritsa" Str., "Vranya-Lozen-

Triugulnika" BG-1151 Sofia, Bulgaria

(111) No. M/1550785

(180) 02/06/2030

(540) Madrid Registration



(511) 09, 28 and 41

(210) No. M/1550951

(220) 02/06/2020

(732) Euro Games Technology Ltd.

4, "Maritsa" Str., "Vranya-Lozen-

Triugulnika" BG-1151 Sofia, Bulgaria

(111) No. M/1550951

(180) 02/06/2030

(540) Madrid Registration



(511) 09, 28 and 41

(210) No. M/1551157

(220) 02/06/2020

(732) Euro Games Technology Ltd.

4, "Maritsa" Str., "Vranya-Lozen-

Triugulnika" BG-1151 Sofia, Bulgaria

(111) No. M/1551157

(180) 02/06/2030

(540) Madrid Registration



(511) 09, 28 and 41

(210) No. M/1551513

(220) 02/06/2020

(732) Euro Games Technology Ltd.

4, "Maritsa" Str., "Vranya-Lozen-  
Triugulnika" BG-1151 Sofia, Bulgaria

(111) No. M/1551513

(180) 02/06/2030

(540) Madrid Registration



(511) 09, 28 and 41

(210) No. M/1551747

(220) 29/05/2020

(732) Euro Games Technology Ltd.

4, "Maritsa" Str., "Vranya-Lozen-  
Triugulnika" BG-1151 Sofia, Bulgaria

(111) No. M/1551747

(180) 29/05/2030

(540) Madrid Registration

**KUSHAQ**

(511) 12

(210) No. M/1580293

(220) 13/12/2023

(732) ŠKODA AUTO a.s.

tř. Václava Klementa 869 CZ-293 01 Mladá

Boleslav, Mladá Boleslav II, Czech Republic

(111) No. M/1580293

(180) 18/12/2030

(540) Madrid Registration

**SLAVIA**

(511) 12

(210) No. M/1580441

(220) 13/12/2023

(732) ŠKODA AUTO a.s.

tř. Václava Klementa 869 CZ-293 01 Mladá

Boleslav, Mladá Boleslav II, Czech Republic

(111) No. M/1580441

(180) 18/12/2030

(540) Madrid Registration



(511) 09, 28 and 41

(210) No. M/1596915

(220) 05/02/2021

(732) Euro Games Technology Ltd.

4, "Maritsa" Str., "Vranya-Lozen-

Triugulnika" BG-1151 Sofia, Bulgaria

(111) No. M/1596915

(180) 05/02/2031

(540) Madrid Registration



(511) 09, 28, 37, 38, 41 and 42

(210) No. M/1703000

(220) 14/07/2022

(732) Euro Games Technology Ltd.

4, "Maritsa" Str., "Vranya-Lozen-

Triugulnika" BG-1151 Sofia, Bulgaria

(111) No. M/1703000

(180) 14/07/2032

(540) Madrid Registration



(511) 09, 28, 37, 38, 41 and 42

(210) No. M/1703562

(220) 14/07/2022

(732) Euro Games Technology Ltd.

4, "Maritsa" Str., "Vranya-Lozen-  
Triugulnika" BG-1151 Sofia, Bulgaria

(111) No. M/1703562

(180) 14/07/2032

(540) Madrid Registration



(511) 09, 28, 37, 38, 41 and 42

(210) No. M/1703563

(220) 14/07/2022

(732) Euro Games Technology Ltd.

4, "Maritsa" Str., "Vranya-Lozen-  
Triugulnika" BG-1151 Sofia, Bulgaria

(111) No. M/1703563

(180) 14/07/2032

(540) Madrid Registration

**FIRE**

(511) 09, 28 and 41

(210) No. M/1732021

(220) 21/12/2022

(732) Euro Games Technology Ltd.

"Maritsa" Str. 4, "Vranya-Lozen-Triugulnika"

BG-1151 Sofia, Bulgaria

(111) No. M/1732021

(180) 21/12/2032

(540) Madrid Registration

*Pennii*

(511) 30

(210) No. M/1765050

(220) 27/09/2023

(732) PENNIN PENNY PATASSERIES CO.,LTD.

39 Soi Petchkasem 84 Bang Khae Nuae Sub-  
district 10160 Bang Khae District, Bangkok,  
Thailand

(111) No. M/1765050

(180) 27/09/2033



(540) Madrid Registration

**NANBEI**

(511) 09

(210) No. M/1765325

(220) 27/09/2023

(732) Nanbei Instrument Limited

No. 03, 26F, Block A, NO. 72 Beihuan Road,  
Jinshui District, Zhengzhou City 450000  
Henan Province, China

(111) No. M/1765325

(180) 27/09/2033

(540) Madrid Registration

**cibacco**

(511) 34

(210) No. M/1765368

(220) 08/10/2023

(732) CHINA TOBACCO JIANGXI

INDUSTRIAL CO., LTD.

Jinsheng Industrial & Technological Park,  
#201, JingDong Avenue, Nanchangcity  
330000 Jiangxi Province, China

(111) No. M/1765368

(180) 08/10/2033

(540) Madrid Registration

**WESTUL**

(511) 07

(210) No. M/1765437

(220) 14/09/2023

(732) Zhejiang Westul Trading Co., Ltd.

Room 503, Building 5B, Jinhua Information  
Economy Industrial Park, Liyu Road, Xiguan  
Street, Wucheng District, Jinhua City 321000  
Zhejiang Province, China

(111) No. M/1765437

(180) 14/09/2033

(540) Madrid Registration

**KEYPOWER**

(511) 07

(210) No. M/1765454

(220) 25/09/2023

(732) KEYPOWER SOLUTIONS(FUJIAN) CO.,  
LTD.

Office 19, Floor 7, Building #2, Hengli Bona  
Plaza (South District), No. 18, North Second  
Ring Middle Road, Huada Street, Gulou  
District, Fuzhou City Fujian Province, China

(111) No. M/1765454

(180) 25/09/2033

(540) Madrid Registration

The logo consists of the letters 'BAW' in a large, bold, serif font.

(511) 12

(210) No. M/1765459

(220) 11/09/2023

(732) Beijing Automobile Works Co., Ltd

South Shuanghe road, Renhe Town, Shunyi

District 101399 Beijing, China

(111) No. M/1765459

(180) 11/09/2033

(540) Madrid Registration

The logo consists of the numbers '212' in a bold, italicized, sans-serif font.

(511) 12

(210) No. M/1765460

(220) 11/09/2023

(732) Beijing Automobile Works Co., Ltd

South Shuanghe road Renhe Town, Shunyi

District 101399 Beijing, China

(111) No. M/1765460

(180) 11/09/2033

(540) Madrid Registration



(511) 28

(210) No. M/1765513

(220) 22/09/2023

(732) Shantou Meitian Trading Co., Ltd

N0. 1-2 of Room 1301, No. 11 Keji Middle  
Road, Shantou High-tech Zone Guangdong  
Province, China

(111) No. M/1765513

(180) 22/09/2033

(540) Madrid Registration



(511) 12

(210) No. M/1765531

(220) 09/10/2023

(732) Dongguan Senlo Photoelectric Technology  
Co., Ltd.

No. 6 room 918, Mulun innovation road,  
Changping town, Dongguan city Guangdong  
province, China

(111) No. M/1765531

(180) 09/10/2033

(540) Madrid Registration

**DATABEYOND**

(511) 07, 09 and 35

(210) No. M/1765546

(220) 07/09/2023

(732) Guangdong DataBeyond Technology Co.,  
Ltd.

Room 325, Building 15, No.1 Xuefu Road,  
Songshan Lake Park, Dongguan City 523808  
Guangdong Province, China

(111) No. M/1765546

(180) 07/09/2033

(540) Madrid Registration

*Fengshangmei*

(511) 03

(210) No. M/1765610

(220) 08/09/2023

(732) XU Hua

Room 1801, Unit 1, Building 4, Golden Coast  
Residential Area, Shangcheng District,  
Hangzhou City Zhejiang Province, China

(111) No. M/1765610

(180) 08/09/2033

(540) Madrid Registration

The logo for HUKO, featuring the word "HUKO" in a bold, black, sans-serif font. The letters are slightly spaced out, and there are small white dots at the top of the 'H' and 'O'.

(511) 03

(210) No. M/1765670

(220) 18/09/2023

(732) Guangzhou huko Technology Co. , Ltd.  
Room 602, No. 11 Hexian North Street,  
Baiyun District, Guangzhou City 510000  
Guangdong, China

(111) No. M/1765670

(180) 18/09/2033

(540) Madrid Registration

The logo for JG, featuring the letters "JG" in a bold, black, stylized font. The letters are slanted and have a modern, geometric appearance.

(511) 34

(210) No. M/1765737

(220) 08/10/2023

(732) CHINA TOBACCO JIANGXI  
INDUSTRIAL CO., LTD.  
Jinsheng Industrial & Technological Park,  
#201, JingDong Avenue, Nanchangcity  
330000 Jiangxi Province, China

(111) No. M/1765737

(180) 08/10/2033

(540) Madrid Registration



(511) 12

(210) No. M/1767418

(220) 14/09/2023

(732) Zhejiang New Gonow Automobile Co.,Ltd.

No. 777 Haihao Road, East New Area,

Taizhou Bay New Area, Taizhou City

Zhejiang Province, China

(111) No. M/1767418

(180) 14/09/2033

(540) Madrid Registration



(511) 35

(210) No. M/1767792

(220) 11/09/2023

(732) Lam Van Trung

No. 9 Le Quang Dinh Street, Ward 13,

District 5 Ho Chi Minh City, Vietnam

(111) No. M/1767792

(180) 11/09/2033

(540) Madrid Registration

The logo for ACMELIAE features the word in a bold, blue, sans-serif font. A horizontal bar with a red-to-white gradient is positioned behind the letters 'M' and 'E'.

(511) 16

(210) No. M/1767801

(220) 19/09/2023

(732) ACMELIAE (TIANJIN) I/E COMPANY

Building 23, Beizeyaju, Cross of Huaidong

Road and Huaihe Zhong Road, Beichen

District Tianjin City, China

(111) No. M/1767801

(180) 19/09/2033

(540) Madrid Registration

The logo for DOTSEN consists of the word in a bold, blue, sans-serif font.

(511) 11

(210) No. M/1767992

(220) 19/09/2023

(732) General Climate DOO Novi Sad

Novi Sad, Zheleznichka 13, Serbia

(111) No. M/1767992

(180) 19/09/2033



(540) Madrid Registration

**FURWAKER**

(511) 07, 08 and 11

(210) No. M/1768419

(220) 09/10/2023

(732) PETKIT Network Technology (Shanghai)

Co., Ltd.

Room 4139, Building 2, No. 588, Zixing

Road, Minhang District 201100 Shanghai,

China

(111) No. M/1768419

(180) 09/10/2033

(540) Madrid Registration

**XANHSM**

(511) 35, 37 and 39

(210) No. M/1768519

(220) 27/09/2023

(732) GSM Green and Smart Mobility Joint Stock

Company

Symphony Office Tower, Chu Huy Man

Street, Vinhomes Riverside Urban Area, Phuc

Loi Ward, Long Bien District Hanoi City,

Vietnam

(111) No. M/1768519

(180) 27/09/2033

(540) Madrid Registration



(511) 05 and 35

(210) No. M/1765512

(220) 22/09/2023

(732) Tianjin Pharmaceutical Da Ren Tang Group  
Corporation Ltd.

No. 17 Bai Di Road, Nankai District Tianjin,  
China

(111) No. M/1765512

(180) 22/09/2033

(540) Madrid Registration

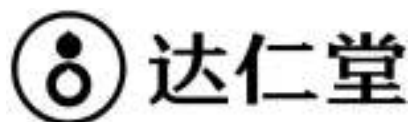

(511) 35

(210) No. M/1765517

(220) 22/09/2023

(732) Tianjin Pharmaceutical Da Ren Tang Group  
Corporation Ltd.

No. 17 Bai Di Road, Nankai District Tianjin,  
China

(111) No. M/1765517

(180) 22/09/2033

(540) Madrid Registration

長城牌



GREAT WALL BRAND

(511) 05

(210) No. M/1765528

(220) 22/09/2023

(732) Tianjin Pharmaceutical Da Ren Tang Group  
Corporation Ltd.

No. 17 Bai Di Road, Nankai District Tianjin,  
China

(111) No. M/1765528

(180) 22/09/2033

(540) Madrid Registration

長城牌



GREAT WALL BRAND

(511) 35

(210) No. M/1765529

(220) 22/09/2023

(732) Tianjin Pharmaceutical Da Ren Tang Group  
Corporation Ltd.

No. 17 Bai Di Road, Nankai District 300110  
Tianjin, China

(111) No. M/1765529

(180) 22/09/2033

(540) Madrid Registration

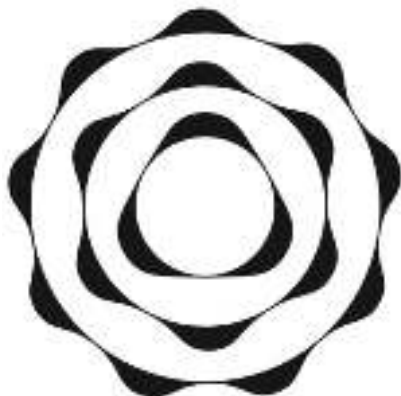

(511)

(210) No. M/1544329

(220) 19/10/2023

(732) Philip Morris Products S.A.

Quai Jeanrenaud 3 CH-2000 Neuchâtel,

Switzerland

(111) No. M/1544329

(180) 23/06/2030

(540) Madrid Registration

**KÖLAX**

(511)

(210) No. M/1747598

(220) 25/10/2023

(732) Yang zhan

No. 18, Building 9, No. 2 Meihu Street,

Jiangdong Street, Yiwu city, Jinhua city

Zhejiang province, China

(111) No. M/1747598

(180) 12/03/2033

(540) Madrid Registration

**AYMCETLA**

(511)

(210) No. M/1762418

(220) 19/12/2023

(732) BioNTech SE

An der Goldgrube 12 55131 Mainz, Germany

(111) No. M/1762418

(180) 27/09/2033

(540) Madrid Registration

**Ohuhu**

(511)

(210) No. M/1769719

(220) 24/10/2023

(732) Yiwu Thousandshores E-Commerce Co.,Ltd

9th Floor, Block A, No.512, Hehua South  
Road, Choujiang Sub-district, Yiwu City

Zhejiang Province, China

(111) No. M/1769719

(180) 24/10/2033

(540) Madrid Registration

**E11EVEN  
ULTRACLUB**

(511)

(210) No. M/1769752

(220) 13/10/2023

(732) GR OPCO, LLC

29 NE 11th Street Miami FL 33132,

United States of America

(111) No. M/1769752

(180) 13/10/2033

(540) Madrid Registration

**CITYRAY**

(511)

(210) No. M/1769771

(220) 13/11/2023

(732) ZHEJIANG GEELY HOLDING GROUP CO.,

LTD.

1760 JIANGLING ROAD, BINJIANG

DISTRICT, HANGZHOU ZHEJIANG,

CHINA

(111) No. M/1769771

(180) 13/11/2033

(540) Madrid Registration

**COLMO**

(511)

(210) No. M/1769785

(220) 04/07/2023

(732) Midea Group Co., Ltd.

B26-28F, Midea Headquarter Building, No. 6

Midea Avenue, Beijiao, Shunde,

Foshan Guangdong, China

(111) No. M/1769785

(180) 04/07/2033

(540) Madrid Registration

**FLEXMEET**

(511)

(210) No. M/1769800

(220) 28/11/2023

(732) Amphenol Aorora Technology (Huizhou) Co.,

Ltd.

No. 8 Factory Bldg, Xikeng Ind Zone,

Huihuan St, Zhongkai Hi-tech Ind Dev Zone,

Huizhou 516006 Guangdong, China

(111) No. M/1769800

(180) 28/11/2033

(540) Madrid Registration



(511)

(210) No. M/1769813

(220) 05/10/2023

(732) BRISK PADEL EUROPE, S.L.

Calle Omerlades, número 2º, A, 1º E-07012

PALMA DE MALLORCA/ILLES

BALEARS, SPAIN

(111) No. M/1769813

(180) 05/10/2033

(540) Madrid Registration

**SANYO**

(511)

(210) No. M/1769815

(220) 06/11/2023

(732) MEDIA ELECTRONICS, S.L.

Avda. Segle XXI, 34 E-08840 Viladecans,

Spain

(111) No. M/1769815

(180) 06/11/2033



(540) Madrid Registration



(511)

(210) No. M/1769850

(220) 14/07/2023

(732) Guangzhou Aotea Biological Technology Pte Ltd.

B108 is Compiled in 1102, No. 8, Jinsui Road, Tianhe District, Guangzhou Guangdong, China

(111) No. M/1769850

(180) 14/07/2033

(540) Madrid Registration



(511)

(210) No. M/1770100

(220) 08/08/2023

(732) SUZHOU DAKE MACHINERY CO., LTD.

NO. 45 SONGBEI ROAD, SUZHOU INDUSTRIAL PARK, SUZHOU CITY 215000 JIANGSU PROVINCE, CHINA

(111) No. M/1770100

(180) 08/08/2033

(540) Madrid Registration



(511)

(210) No. M/1770101

(220) 08/08/2023

(732) SUZHOU DAKE MACHINERY CO., LTD.

NO. 45 SONGBEI ROAD, SUZHOU

INDUSTRIAL PARK, SUZHOU CITY

215000 JIANGSU PROVINCE, CHINA

(111) No. M/1770101

(180) 08/08/2033

(540) Madrid Registration



(511)

(210) No. M/1770196

(220) 22/11/2023

(732) Symius, Inc.

15133 Praire Pl Broomfield CO 80023,

United States of America

(111) No. M/1770196

(180) 22/11/2033

(540) Madrid Registration

**Magic Portal**

(511)

(210) No. M/1770335

(220) 28/11/2023

(732) Honor Device Co., Ltd.

Suite 3401, Unit A, Building 6, Shum Yip Sky  
Park, No. 8089, Hongli West Road, Xiangmihu  
Street, Futian District, Shenzhen 518040  
Guangdong, China

(111) No. M/1770335

(180) 28/11/2033

(540) Madrid Registration

**T-OPT**

(511)

(210) No. M/1770355

(220) 08/12/2023

(732) Toyota Motor Asia (Singapore) Pte. Ltd.

1 WALLICH STREET, #36-01 GUOCO  
TOWER SINGAPORE 078881

(111) No. M/1770355

(180) 08/12/2033

(540) Madrid Registration



(511)

(210) No. M/1770431

(220) 01/09/2023

(732) Fédération Internationale de Football

Association (FIFA)

FIFA-Strasse 20 CH-8044 Zürich,

Switzerland

(111) No. M/1770431

(180) 01/09/2033

(540) Madrid Registration



(511)

(210) No. M/1770432

(220) 31/08/2023

(732) Fédération Internationale de Football

Association (FIFA)

FIFA-Strasse 20 CH-8044 Zürich,

Switzerland

(111) No. M/1770432

(180) 31/08/2033

(540) Madrid Registration

**TOPOW**

(511)

(210) No. M/1770519

(220) 04/07/2023

(732) ZHEJIANG TOPOW SEWING MACHINE  
TECHNOLOGY CO., LTD.

No. 2299, Jingzhong Road, Hongjia Street,  
Jiaojiang District, Taizhou City Zhejiang  
Province, China

(111) No. M/1770519

(180) 04/07/2033

(540) Madrid Registration

**MRL**

(511)

(210) No. M/1770570

(220) 22/09/2023

(732) MRL TYRES LIMITED

70/50 a, first floor rama road indl. area  
najaagarhroad, moti nagar new delhi 110015,  
India

(111) No. M/1770570

(180) 22/09/2033

(540) Madrid Registration



(511)

(210) No. M/1770574

(220) 27/09/2023

(732) HOUSSAM EL BADAoui

Rua Nanau, n° 92, apt° 102, Água Fria  
02335-040 São Paulo, Brazil

(111) No. M/1770574

(180) 27/09/2033

(540) Madrid Registration



(511)

(210) No. M/1770611

(220) 27/10/2023

(732) Apple Inc.

One Apple Park Way Cupertino CA 95014,  
United States of America

(111) No. M/1770611

(180) 27/10/2033

(540) Madrid Registration

**ID&E**

(511)

(210) No. M/1770694

(220) 15/11/2023

(732) Integrated Design & Engineering Holdings  
Co., Ltd.

5-4 Kojimachi, Chiyoda-ku Tokyo 102-8539,  
Japan

(111) No. M/1770694

(180) 15/11/2033

(540) Madrid Registration

**HONEYWHALE**

(511)

(210) No. M/1770704

(220) 20/10/2023

(732) SHENZHEN MINZHUO TECHNOLOGY  
CO., LTD.

1303 Hai'an Huanqing Building, No. 24  
Futian Road, Xuzhen Community, Futian  
Street, Futian District Shenzhen, China

(111) No. M/1770704

(180) 20/10/2033

(540) Madrid Registration



BEAUTÉ  
DANS  
LA PERMANENCE

(511)

(210) No. M/1770744

(220) 07/11/2023

(732) DR. DESIGNER Co., Ltd.; LEE, JINBAEG;

KWON, SOONWOO and PARK,

KYUNGMIN

#1719, 10, Tongil-ro, Jung-gu Seoul,

Republic of Korea; 135-1103, 266, Kangseo-

ro, Kangseogu Seoul, Republic of Korea;

202-2203, 60, Guil-ro 2-gil, Guro-gu Seoul,

Republic of Korea and 316-304, 90, Seodal-

ro, Dongjak-gu Seoul, Republic of Korea

(111) No. M/1770744

(180) 07/11/2033

(540) Madrid Registration



(511)

(210) No. M/1770746

(220) 07/11/2023

(732) DR. DESIGNER Co., Ltd.; LEE, JINBAEG;

KWON, SOONWOO and PARK,

KYUNGMIN

#1719, 10, Tongil-ro, Jung-gu Seoul,

Republic of Korea; 135-1103, 266, Kangseo-

ro, Kangseogu Seoul, Republic of Korea;

202-2203, 60, Guil-ro 2-gil, Guro-gu Seoul,

Republic of Korea and 316-304, 90,

Seodal-ro, Dongjak-gu Seoul,

Republic of Korea

(111) No. M/1770746

(180) 07/11/2033



(540) Madrid Registration



(511)

(210) No. M/1770962

(220) 25/09/2023

(732) INDUSTRIA DE DISEÑO TEXTIL, S.A.

(INDITEX, S.A.)

Avenida de la Diputación, "Edificio Inditex"

E-15142 Arteixo (A Coruña), Spain

(111) No. M/1770962

(180) 25/09/2033

(540) Madrid Registration



(511)

(210) No. M/1771047

(220) 10/08/2023

(732) LIXIL Corporation

Osaki Garden Tower, 1-1-1 Nishishinagawa,

Shinagawa-ku Tokyo 141-0033, Japan

(111) No. M/1771047

(180) 10/08/2033

(540) Madrid Registration



(511)

(210) No. M/1771094

(220) 01/12/2023

(732) Finesse US Inc.

734 S. Main Street, Floor 4 Los Angeles CA  
90014, United States of America

(111) No. M/1771094

(180) 01/12/2033

(540) Madrid Registration



(511)

(210) No. M/1771103

(220) 19/09/2023

(732) CITIC Dicastal Co., Ltd

No. 185 Longhai Ave, Economic and  
Technological Development Zone,  
Qinhuangdao City Hebei Province, China

(111) No. M/1771103

(180) 19/09/2033

(540) Madrid Registration



(511)

(210) No. M/1771130

(220) 15/11/2023

(732) Integrated Design & Engineering Holdings  
Co., Ltd.

5-4 Kojimachi, Chiyoda-ku Tokyo 102-8539,  
Japan

(111) No. M/1771130

(180) 15/11/2033

(540) Madrid Registration

**Shining Cash**

(511)

(210) No. M/1771131

(220) 29/03/2023

(732) Euro Games Technology Ltd.

6 Panorama Sofia Str., Richhill Business  
Center, ground floor, Vitosha region BG-1766  
Sofia, Bulgaria

(111) No. M/1771131

(180) 29/03/2033

(540) Madrid Registration

## **Exclusive Hot**

(511)

(210) No. M/1771133

(220) 28/06/2023

(732) Euro Games Technology Ltd.

6 Panorama Sofia Str., Richhill Business

Center, ground floor, Vitosha region BG-1766

Sofia, Bulgaria

(111) No. M/1771133

(180) 28/06/2033

(540) Madrid Registration

## **Super Power**

(511)

(210) No. M/1771134

(220) 13/07/2023

(732) Euro Games Technology Ltd.

6 Panorama Sofia Str., Richhill Business

Center, ground floor, Vitosha region BG-1766

Sofia, Bulgaria

(111) No. M/1771134

(180) 13/07/2033

(540) Madrid Registration

**Shining Power**

(511)

(210) No. M/1771135

(220) 13/07/2023

(732) Euro Games Technology Ltd.

6 Panorama Sofia Str., Richhill Business

Center, ground floor, Vitosha region BG-1766

Sofia, Bulgaria

(111) No. M/1771135

(180) 13/07/2033

(540) Madrid Registration

**Burning Power**

(511)

(210) No. M/1771136

(220) 13/07/2023

(732) Euro Games Technology Ltd.

6 Panorama Sofia Str., Richhill Business

Center, ground floor, Vitosha region BG-1766

Sofia, Bulgaria

(111) No. M/1771136

(180) 13/07/2033

(540) Madrid Registration



(511)

(210) No. M/1771170

(220) 29/12/2022

(732) «Design and Technology Bureau «SPRING»

LLC

Stantsionnaya ul., d. 30A, of. 109

Novosibirsk RU-630108 Novosibirskaya

oblast', Russian Federation

(111) No. M/1771170

(180) 29/12/2032

(540) Madrid Registration



(511)

(210) No. M/1771172

(220) 13/07/2023

(732) Euro Games Technology Ltd.

6 Panorama Sofia Str., Richhill Business

Center, ground floor, Vitosha region

BG-1766 Sofia, Bulgaria

(111) No. M/1771172

(180) 13/07/2033

(540) Madrid Registration

**WELLBAR**

(511)

(210) No. M/1771206

(220) 17/11/2023

(732) JOINT STOCK COMPANY BRAND

BUILDING GROUP

per. Bolshoj Savvinskij, d. 11, pom. 1/3/4,

vn.ter.g. municipalnyj okrug Xamovniki RU-

119435 Moscow, Russian Federation

(111) No. M/1771206

(180) 17/11/2033

(540) Madrid Registration

**LAND-DWELLER**

(511)

(210) No. M/1771297

(220) 13/11/2023

(732) ROLEX SA

Rue François-Dussaud 3-5-7 CH-1211

Genève 26, Switzerland

(111) No. M/1771297

(180) 13/11/2033

(540) Madrid Registration



(511)

(210) No. M/1771456

(220) 14/09/2023

(732) ARISE IIP INDIA PRIVATE LIMITED

1010, indra prakash, 21 barakhamba road new  
delhi 110001, India

(111) No. M/1771456

(180) 14/09/2033

(540) Madrid Registration



(511)

(210) No. M/1771511

(220) 06/11/2023

(732) Stropus Ltd.

Lizantia Court, office 310, Agioi Omologites  
CY-1087 Nicosia, Cyprus

(111) No. M/1771511

(180) 06/11/2033



(540) Madrid Registration



(511)

(210) No. M/1771534

(220) 27/07/2023

(732) Limited Liability Company "Binnopharm Group"

Kozhevnickeskaya str., 14, building 5, floor 3, room. 17, Danilovsky Municipal District, intercity territory of the city RU-115114 Moscow, Russian Federation

(111) No. M/1771534

(180) 27/07/2033

(540) Madrid Registration



(511)

(210) No. M/1771565

(220) 25/10/2023

(732) Dongguan Yangchen Furniture Co., Ltd

Room 101, Building 1, No. 255, Dalingshan Section, Guanchang Road, Dalingshan Town, Dongguan City 523000 Guangdong Province, China

(111) No. M/1771565

(180) 25/10/2033

(540) Madrid Registration

**BRIGHTCONNX**

(511)

(210) No. M/1771618

(220) 23/10/2023

(732) Amphenol Canada Corp.

5950 14th Avenue Markham ON L3S4M4,  
Canada

(111) No. M/1771618

(180) 23/10/2033

(540) Madrid Registration

**aditi 阿底提**

(511)

(210) No. M/1771635

(220) 17/10/2023

(732) Guangzhou Deyi Cosmetics Co., Ltd

Room 102, 1st Floor, Building 2, Greenland  
Huichuang Plaza, No. 6Kexing Road,  
Guangzhou Private Science and Technology  
Park, No. 1633 Beitai Road, Baiyun District,  
Guangzhou City 510415 Guangdong  
Province, China

(111) No. M/1771635

(180) 17/10/2033

(540) Madrid Registration



(511)

(210) No. M/1771681

(220) 03/11/2023

(732) Nanao Leather Articles Co., Ltd.

No.310, Shengshe New Street, Zhili Town,  
Wuxing District, Huzhou 313000 Zhejiang,  
China

(111) No. M/1771681

(180) 03/11/2033

(540) Madrid Registration



(511)

(210) No. M/1771726

(220) 20/10/2023

(732) Shenzhen Hui Kun Technology Co.,LTD

Floor 3-4, Building 3, Saitu Digital Industrial  
Factory, No.137, Bulan Road, Gankeng  
Community, Jihua Street, Longgang District,  
Shenzhen 518100 Guangdong, China

(111) No. M/1771726

(180) 20/10/2033

(540) Madrid Registration

**KUANGXIANG**

(511)

(210) No. M/1771733

(220) 29/08/2023

(732) Shenzhen Kuangxiang Technology Co., Ltd.

807, No.51, Pingxin North Road, Shangmugu

Community, Pinghu Street, Longgang

District, Shenzhen Guangdong Province,

China

(111) No. M/1771733

(180) 29/08/2033

(540) Madrid Registration

**ZXTec**

(511)

(210) No. M/1771943

(220) 15/11/2023

(732) JIANGSU ZHONGXING MOTORCYCLE

CO., LTD.

Xihu Road, Zhaqiao, Anzhen Town, Xishan

District, Wuxi City 214000 Jiangsu Province,

China

(111) No. M/1771943

(180) 15/11/2033

(540) Madrid Registration

**WORSHIP**

(511)

(210) No. M/1771950

(220) 27/09/2023

(732) Guangdong Mancando Information

Technology Co., Ltd.

Floor 22 (Whole Floor), Vanke Sanyuanli

Center, No. 31, Airport Road, Baiyun

District, Guangzhou City 510080 Guangdong

Province, China

(111) No. M/1771950

(180) 27/09/2033

(540) Madrid Registration

**SPATIAL CAPTURE**

(511)

(210) No. M/1771963

(220) 08/12/2023

(732) Apple Inc.

One Apple Park Way Cupertino CA 95014,

United States of America

(111) No. M/1771963

(180) 08/12/2033

(540) Madrid Registration

**SPATIAL CAPTURE**

(511)

(210) No. M/1771964

(220) 08/12/2023

(732) Apple Inc.

One Apple Park Way Cupertino CA 95014,  
United States of America

(111) No. M/1771964

(180) 08/12/2033

(540) Madrid Registration

 **CUTOP**

(511)

(210) No. M/1772219

(220) 19/10/2023

(732) Yangquan Zhongjia Abrasives Co., Ltd.

Baiquan Industrial Zone, Miaoling, Yangquan  
Shanxi, China

(111) No. M/1772219

(180) 19/10/2033

(540) Madrid Registration



(511)

(210) No. M/1772229

(220) 19/10/2023

(732) Yangquan Zhongjia Abrasives Co., Ltd.

Baiquan Industrial Zone, Miaoling, Yangquan  
Shanxi, China

(111) No. M/1772229

(180) 19/10/2033

(540) Madrid Registration



(511)

(210) No. M/1772283

(220) 16/10/2023

(732) Ningbo Oupu Electric Appliance Co., Ltd.

Mayan Village, Henghe Town, Cixi City  
Zhejiang, China

(111) No. M/1772283

(180) 16/10/2033

(540) Madrid Registration

The logo for "NAVER pay" features the word "NAVER" in a bold, black, sans-serif font, followed by "pay" in a smaller, lowercase, black, sans-serif font.

(511)

(210) No. M/1772291

(220) 16/11/2023

(732) NAVER Corporation

(Jeongja-dong) NAVER 1784, 95, Jeongjaill-ro, Bundang-gu Seongnam-si Gyeonggi-do, Republic of Korea

(111) No. M/1772291

(180) 16/11/2033

(540) Madrid Registration

The logo for "deNaX" features the text "deNaX" in a bold, black, sans-serif font, enclosed within a rectangular border.

(511)

(210) No. M/1772313

(220) 01/12/2023

(732) ARM Corp.

#6054, 6F, 29 Jukjeon-ro, Giheung-gu, Yongin-si Gyeonggi-do 16898, Republic of Korea

(111) No. M/1772313

(180) 01/12/2033



(540) Madrid Registration

 **KDFinechem**

(511)

(210) No. M/1772398

(220) 11/12/2023

(732) KD Finechem Co., Ltd.

3F, 135, Hasinbeonyeong -ro, Saha-gu Busan,  
Republic of Korea

(111) No. M/1772398

(180) 11/12/2033

(540) Madrid Registration

**HomeRunpet**

(511)

(210) No. M/1772442

(220) 14/11/2023

(732) Shenzhen Qianhai Homerun Smart

Technology Co., Ltd.

Room 201, Block A, No.1 Qianwan Road 1,  
Qianhai Shenzhen-Hong Kong Cooperation  
Zone Shenzhen, Guangdong, China

(111) No. M/1772442

(180) 14/11/2033

(540) Madrid Registration

Bluedge

(511)

(210) No. M/1772464

(220) 23/11/2023

(732) Shanghai Zhongxing Enterprise Management

Center (Limited Partnership)

Room 5050, Building 3, No. 201, Aihui

Road, Baoshan District 201900 Shanghai

City, China

(111) No. M/1772464

(180) 23/11/2033

(540) Madrid Registration

DACHENG

(511)

(210) No. M/1772503

(220) 23/11/2023

(732) Beijing Dacheng Law Offices, LLP

16-21F, Tower B, ZT International Center,

No. 10, Chaoyangmen Nandajie, Chaoyang

District Beijing, China

(111) No. M/1772503

(180) 23/11/2033

(540) Madrid Registration

KIYOMIN PROJECT

(511)

(210) No. M/1772531

(220) 09/11/2023

(732) PARK, Yoon Hee

101-1502, 49, Gyeongin-ro 43-gil, Guro-gu

Seoul 08226, Republic of Korea

(111) No. M/1772531

(180) 09/11/2033

(540) Madrid Registration

**MPRO**

(511)

(210) No. M/1772554

(220) 14/11/2023

(732) YiWu KeMei Electric Appliance CO., Ltd.

No. 1377-1, Yinhai International Business

Center, No. 1377 Chouzhou North Road,

Futian Street, Yiwu City Zhejiang Province,

China

(111) No. M/1772554

(180) 14/11/2033

(540) Madrid Registration



(511)

(210) No. M/1772569

(220) 14/09/2023

(732) ARISE IIP INDIA PRIVATE LIMITED

1010, indra prakash, 21 barakhamba road new  
delhi 110001, India

(111) No. M/1772569

(180) 14/09/2033

(540) Madrid Registration



(511)

(210) No. M/1772570

(220) 19/09/2023

(732) Arise IIP India Private Limited

1010, indra prakash, 21 barakhamba road,  
new delhi 110001, India

(111) No. M/1772570

(180) 19/09/2033

(540) Madrid Registration

**HOLOZ**

(511)

(210) No. M/1772579

(220) 16/10/2023

(732) Guangdong Holowits Technologies

Enterprise (Limited Partnership)

5F-520, Block A, New World Briuida

Building, Wanke City Community, Bantian

Street, Longgang District Shenzhen City,

Guangdong Province, China

(111) No. M/1772579

(180) 16/10/2033

(540) Madrid Registration

**LADY'S CARDS**

(511)

(210) No. M/1772749

(220) 03/08/2023

(732) Euro Games Technology Ltd.

4, "Maritsa" Str., "Vranya-Lozen-

Triugulnika" BG-1151 Sofia, Bulgaria

(111) No. M/1772749

(180) 03/08/2033

(540) Madrid Registration



(511)

(210) No. M/1772799

(220) 19/10/2023

(732) JINGMEN HONGTU SPECIAL AIRCRAFT  
MANUFACTURING CO., LTD.

No. 16 Yingchun Avenue, Duodao District,  
Jingmen High-tech Zone, Jingmen City  
448124 Hubei Province, China

(111) No. M/1772799

(180) 19/10/2033

(540) Madrid Registration



(511)

(210) No. M/1772934

(220) 24/10/2023

(732) Guangzhou Meixiusi Cosmetics Co., Ltd.

Room 110, Building 3, No. 25, Wanggang  
Industrial Zone 2nd Road, Jiahe Street,  
Baiyun District, Guangzhou City Guangdong  
Province, China

(111) No. M/1772934

(180) 24/10/2033

(540) Madrid Registration

**INNOLINK**

(511)

(210) No. M/1772972

(220) 25/10/2023

(732) DELI GROUP CO., LTD.

Deli Industrial Park, Ninghai County,

Ningbo 310008 Zhejiang, China

(111) No. M/1772972

(180) 25/10/2033

(540) Madrid Registration

**BELL LINK BOOST**

(511)

(210) No. M/1773073

(220) 31/07/2023

(732) Euro Games Technology Ltd.

4, "Maritsa" Str., "Vranya-Lozen-Triugulnika"

BG-1151 Sofia, Bulgaria

(111) No. M/1773073

(180) 31/07/2033

(540) Madrid Registration

**AMOS**

(511) 10

(210) No. M/1377704

(220) 12/12/2023

(732) Asian MOS Company Limited

175/154 Soi Sukhumvit 39, Sukhumvit Road

10110 Klongton-Nua, Wattana, Bangkok,

Thailand

(111) No. M/1377704

(180) 16/08/2027

(540) Madrid Registration

**The Different  
Company**  

(511) 03 and 04

(210) No. M/1483487

(220) 12/12/2023

(732) THE DIFFERENT COMPANY FRANCE

37 rue Louise Weiss F-75013 PARIS,

FRANCE

(111) No. M/1483487

(180) 14/06/2029



(540) Madrid Registration



(511) 14, 18, 25, 28 and 41

(210) No. M/1690388

(220) 05/12/2023

(732) KUKKIWON

(Yeoksam-dong), 32, Teheran-ro 7-gil,  
Gangnam-gu Seoul, Republic of Korea

(111) No. M/1690388

(180) 22/07/2032

(540) Madrid Registration



(511) 29 and 30

(210) No. M/1759994

(220) 24/11/2023

(732) SANYA ZHIBUZHI CONSULTING CO.,  
LTD.

1803, China Construction Bank Complex  
Building, No.100 Commodity Street Avenue,  
Jiyang District Sanya City, Hainan Province,  
China

(111) No. M/1759994

(180) 07/04/2033

(540) Madrid Registration

**YOUNGKIT**

(511) 09

(210) No. M/1770339

(220) 21/11/2023

(732) Guangzhou Laigu Technology Co., Ltd.

Room 312, Building 4, No. 24, Xinyi Road,

Liwan District, Guangzhou 510000

Guangdong, China

(111) No. M/1770339

(180) 21/11/2033

(540) Madrid Registration

**FOTON WONDER**

(511) 12 and 35

(210) No. M/1770723

(220) 27/11/2023

(732) BEIQI FOTON MOTOR CO., LTD.

Laoniawan Village North, Shayang Road,

Shahe Town, Changping District 102206

Beijing, China

(111) No. M/1770723

(180) 27/11/2033

(540) Madrid Registration

**omega3zone**

(511) 05, 35 and 44

(210) No. M/1770950

(220) 08/12/2023

(732) omega3zone GmbH

Josephsplatz 8 90403 Nürnberg, Germany

(111) No. M/1770950

(180) 08/12/2033

(540) Madrid Registration

**VEPOSS**

(511) 12

(210) No. M/1771830

(220) 12/12/2023

(732) Jite (Tianjin) Vehicle Materials Co., Ltd

Xiaojie Village Industrial Park, Shuangjie

Town, Beichen District 300000 Tianjin City,

China

(111) No. M/1771830

(180) 12/12/2033

(540) Madrid Registration

The logo for 'TUTU TIME' consists of the words 'TUTU' and 'TIME' in a bold, uppercase, sans-serif font. The letters are widely spaced, and the 'T' in 'TUTU' is significantly larger than the other letters.

(511) 03

(210) No. M/1771867

(220) 22/11/2023

(732) Lyu Xiaoli

No. 304, Group 2, Daxing Village, Hebao  
Town, Rongchang County Chongqing City,  
China

(111) No. M/1771867

(180) 22/11/2033

(540) Madrid Registration

The logo for 'BRAND'S' features the word 'BRAND'S' in a bold, uppercase, sans-serif font. Above the 'A' is a stylized arch or bridge shape.

(511) 05, 29, 30 and 32

(210) No. M/1771916

(220) 30/11/2023

(732) SUNTORY BEVERAGE & FOOD ASIA

PTE. LTD.

400 ORCHARD ROAD, #11-12 ORCHARD  
TOWERS SINGAPORE 238875

(111) No. M/1771916

(180) 30/11/2033

(540) Madrid Registration

**ONEONE**

(511) 09

(210) No. M/1772170

(220) 12/12/2023

(732) Stylemark Co.,Ltd.

Area A, 3/F,Building 01#, NO.150 South  
Longshan Road, Siming District, Xiamen  
Fujian, China

(111) No. M/1772170

(180) 12/12/2033

(540) Madrid Registration

**SANTAN**

(511) 09 and 11

(210) No. M/1772197

(220) 12/12/2023

(732) Jiangmen Santan Lighting Technology Co.,  
Ltd.

The first, second, and third floors of Huaheng  
Lighting Factory in Niugutian Dawei  
Industrial Zone, Muzhou Town, Xinhui  
District, Jiangmen City 529000 Guangdong,  
China

(111) No. M/1772197

(180) 12/12/2033

(540) Madrid Registration



(511) 30

(210) No. M/1772250

(220) 29/11/2023

(732) YAKE (CHINA) CO., LTD.

Wuli Industrial Zone, Jinjiang City 362200

Fujian Province, China

(111) No. M/1772250

(180) 29/11/2033

(540) Madrid Registration



(511) 07

(210) No. M/1772425

(220) 12/12/2023

(732) Shandong FUJIZY Elevator Co., Ltd.

South End of Taishan Road, Economic

Development Zone, Ningjin County, Dezhou

City Shandong, China

(111) No. M/1772425

(180) 12/12/2033

(540) Madrid Registration



(511) 11

(210) No. M/1772530

(220) 12/12/2023

(732) WUXI ZOZEN BOILERS CO., LTD.

No. 76 Xingda Road, Fenshui Village,

Zhoutie Town, Yixing City 210000 Jiangsu

Province, China

(111) No. M/1772530

(180) 12/12/2033

(540) Madrid Registration



(511) 09

(210) No. M/1772557

(220) 13/12/2023

(732) Apple Inc.

One Apple Park Way Cupertino CA 95014,

United States of America

(111) No. M/1772557

(180) 13/12/2033

(540) Madrid Registration

The logo for Teison, featuring the word "Teison" in a bold, black, sans-serif font. The letter 'i' has a small leaf-like shape above it.

(511) 09

(210) No. M/1772639

(220) 28/11/2023

(732) Teison Energy Technology Co.,Ltd

No.9 Meihu Road, Yangzhou City 225000

Jiangsu Province, China

(111) No. M/1772639

(180) 28/11/2033

(540) Madrid Registration

The logo for NOURSE, featuring the Chinese characters "卫仕" (Wei Shi) in a bold, black, sans-serif font above the word "NOURSE" in a bold, black, sans-serif font.

(511) 05 and 31

(210) No. M/1772663

(220) 24/11/2023

(732) Shanghai Chowsing Pet Products Co., Ltd

Room 301-007, Building 1, No. 398,

Shuanglian Road, Xujing Town, Qingpu

District Shanghai, China

(111) No. M/1772663

(180) 24/11/2033



(540) Madrid Registration



(511) 05

(210) No. M/1772932

(220) 24/11/2023

(732) KINGDOM HEALTHCARE HOLDINGS  
LIMITED. GUANGDONG

No. 23, East Baoshi Road, Guicheng Avenue,  
Nanhai District, Foshan City Guangdong  
Province, China

(111) No. M/1772932

(180) 24/11/2033

(540) Madrid Registration



(511) 03

(210) No. M/1772982

(220) 28/11/2023

(732) Guangzhou Aise Biotechnology Co., Ltd

(Airport Baiyun) 304, Block C, No. 13  
Tongfu Road, Renhe Town, Baiyun District,  
Guangzhou Guangdong Province, China

(111) No. M/1772982

(180) 28/11/2033

(540) Madrid Registration



(511) 08

(210) No. M/1772983

(220) 29/11/2023

(732) Chongqing Lanyatian Industry and Trade Co.,  
Ltd

No.7, Xindaqiao Industrial Park, Yongyi

Community 1, Longshui Town, Dazu District

402368 Chongqing, China

(111) No. M/1772983

(180) 29/11/2033

(540) Madrid Registration

SOONBOX

(511) 09 and 35

(210) No. M/1773087

(220) 27/11/2023

(732) Dongguan LingChao Electronic Technology  
Co., Ltd.

Room 101, Building 1, No. 9, First Street,

Zhenxing West Road, Changping Town,

Dongguan City 523581 Guangdong Province,

China

(111) No. M/1773087

(180) 27/11/2033

(540) Madrid Registration



(511) 43

(210) No. M/1773128

(220) 08/12/2023

(732) Yanbian Heba Catering Management Co.,  
Ltd.

2F, No. 2001, No. 463-4, Yanhe Street, Yanji  
City, Yanbian Prefecture Jilin Province,  
China

(111) No. M/1773128

(180) 08/12/2033

## ພາກທີ IV

### (Part IV)

## ເຄື່ອງໝາຍການຄ້າຜ່ານລະບົບມາດຣິດ

## Trademarks via Madrid Protocol

### 3. ຜົນການຕໍ່ອາຍຸ

#### (Renewal)

#### ຄຳອະທິບາຍກ່ຽວກັບລະຫັດຫຍໍ້

#### (Introduction of Codes)

- (540) ເຄື່ອງໝາຍການຄ້າ (Trademark)
- (511) ໝວດ (Nice Classification)
- (210) ເລກທີ ຄຳຮ້ອງ (Number of the application)
- (220) ວັນທີ ຍື່ນຄຳຮ້ອງ (Date of filing of the application)
- (732) ຊື່ ແລະ ທີ່ຢູ່ ຂອງຜູ້ຍື່ນຄຳຮ້ອງ (Name and Address of applicant)
- (111) ເລກທີການຈົດທະບຽນເຄື່ອງໝາຍການຄ້າ (Number of the registration)
- (180) ການຕໍ່ອາຍຸຂອງການຈົດທະບຽນ (Expiration date of the renewal)

**ພາກທີ IV**

**(Part IV)**

**ເຄື່ອງໝາຍການຄ້າຜ່ານລະບົບມາດຣິດ**

**Trademarks via Madrid Protocol**

**4. ການປ່ຽນແປງ**

**(Changes)**

**ພາກທີ IV**

**(Part IV)**

**ເຄື່ອງໝາຍການຄ້າຜ່ານລະບົບມາດຣິດ**

**Trademarks via Madrid Protocol**

**5. ການດັດແກ້**

**(Amendments)**

ພາກທີ V  
(Part V)  
ຖິ່ນກຳເນີດ  
**Geographical Indications**

1. ຄຳຮ້ອງ  
(Applications)

ພາກທີ V  
(Part V)  
ຖິ່ນກຳເນີດ  
**Geographical Indications**

2. ຜົນການຈົດທະບຽນ  
(Registration)



ພາກທີ V  
(Part V)  
ຖິ່ນກຳເນີດ  
**Geographical Indications**

2.1 ຜົນການຈັດທະບຽນ ຜ່ານລະບົບສາກົນ  
(Lisbon Registration)

ພາກທີ V

(Part V)

ຖິ່ນກຳເນີດ

**Geographical Indications**

2.2 ຜົນການຈົດທະບຽນ ຊື່ຖິ່ນກຳເນີດສະເພາະ ຜ່ານລະບົບສາກົນ

**(Lisbon Appellation of Origin Registration)**

**ພາກທີ V**

**(Part V)**

**ຖິ່ນກຳເນີດ**

**Geographical Indications**

**3. ການປ່ຽນແປງ**

**(Changes)**

**ພາກທີ V**  
**(Part V)**  
**ຖິ່ນກຳເນີດ**  
**Geographical Indications**

**4. ການດັດແກ້**  
**(Amendments)**

**ພາກທີ VI**

**(Part VI)**

**ພັນພືດໃໝ່**

**New Plant Varieties**

**1. ຄໍາຮ້ອງ**

**(Applications)**

**ພາກທີ VI**

**(Part VI)**

**ພັນພືດໃໝ່**

**New Plant Varieties**

**2. ຜົນການຈັດທະບຽນ**

**(Registration)**

**ພາກທີ VI**

**(Part VI)**

**ພັນພືດໃໝ່**

**New Plant Varieties**

**3. ການປ່ຽນແປງ**

**(Changes)**

**ພາກທີ VI**

**(Part VI)**

**ພັນພືດໃໝ່**

**New Plant Varieties**

**4. ການດັດແກ້**

**(Amendments)**



**ພາກທີ VII**

**(Part VII)**

**ລິຂະສິດ ແລະ ສິດກ່ຽວຂ້ອງກັບລິຂະສິດ**

**Copyrights and Related Rights**

**1. ການແຈ້ງຂໍ້ມູນ**

**(Notifications)**

**ພາກທີ VII**

**(Part VII)**

**ລິຂະສິດ ແລະ ສິດກ່ຽວຂ້ອງກັບລິຂະສິດ**

**Copyrights and Related Rights**

**2. ການປ່ຽນແປງ**

**(Changes)**

**ພາກທີ VIII**

**(Part VIII)**

**ການແກ້ໄຂຂໍ້ຂັດແຍ່ງທາງດ້ານບໍລິຫານກ່ຽວກັບການຈົດທະບຽນຊັບ  
ສິນອຸດສາຫະກຳ ແລະ ພັນພືດໃໝ່**

**Administrative Dispute Resolutions on the Registration of  
Industrial Property and New Plant Varieties**

**1. ຜົນການຄັດຄ້ານຄຳຮ້ອງ**

**(Result of Oppositions)**

**ພາກທີ VIII**

**(Part VIII)**

**ການແກ້ໄຂຂໍ້ຂັດແຍ່ງທາງດ້ານບໍລິຫານກ່ຽວກັບການຈັດທະບຽນຊັບ  
ສິນອຸດສາຫະກຳ ແລະ ພັນພືດໃໝ່**

**Administrative Dispute Resolutions on the Registration of  
Industrial Property and New Plant Varieties**

**2. ຜົນການແຈ້ງປະຕິເສດ**

**(Result of Refusals)**

**ພາກທີ VIII**

**(Part VIII)**

**ການແກ້ໄຂຂໍ້ຂັດແຍ່ງທາງດ້ານບໍລິຫານກ່ຽວກັບການຈົດທະບຽນຊັບ  
ສິນອຸດສາຫະກຳ ແລະ ພັນພືດໃໝ່**

**Administrative Dispute Resolutions on the Registration of  
Industrial Property and New Plant Varieties**

**3. ຜົນການຍົກເລີກ ຫຼື ລົບລ້າງ ຂອງການຈົດທະບຽນ  
(Result of Cancellation or Invalidation of Registration)**