



ສາທາລະນະລັດ ປະຊາທິປະໄຕ ປະຊາຊົນລາວ
LAO PEOPLE'S DEMOCRATIC REPUBLIC

ກະຊວງ ອຸດສາຫະກຳ ແລະ ການຄ້າ
ກົມຊັບສິນທາງປັນຍາ
MINISTRY OF INDUSTRY AND COMMERCE
DEPARTMENT OF INTELLECTUAL PROPERTY

ຈົດໝາຍເຫດທາງລັດຖະການ
ກ່ຽວກັບ ຊັບສິນທາງປັນຍາ
ຢູ່ ສປປ ລາວ

OFFICIAL GAZETTE ON INTELLECTUAL PROPERTY
IN LAO PDR

ພາກທີ I

(Part I)

ສິດທິບັດ ແລະ ອະນຸສິດທິບັດ (Patent and Petty Patent)

1. ຄໍາຮ້ອງ (Applications)

ຄໍາອະທິບາຍກ່ຽວກັບລະຫັດຫຍໍ້ (Introduction of Codes)

- (21) ເລກທີ ຄໍາຮ້ອງ (Filing Number)
- (22) ວັນທີ ຍືນຄໍາຮ້ອງ (Filing Date)
- (30) ວັນທີ ບຸລິມະສິດ (Priority Date)
- (43) ວັນທີເຜີຍແຜ່ (Publication Date)
- (51) ໝວດ (International Patent Classification)
- (54) ຊື່ຂອງການປະດິດ (Title)
- (57) ບົດຄັດຫຍໍ້ (Abstract)
- (71) ຊື່ ແລະ ທີ່ຢູ່ ເຈົ້າຂອງສິດທິບັດ ແລະ ອະນຸສິດທິບັດ (Owner Name and Address)
- (72) ຊື່ຜູ້ປະດິດ (Inventor Name)
- (74) ຊື່ຕົວແທນ (Representative Name)
- (55) ຮູບພາບ (Pictures)

ພາກທີ I

(Part I)

ສິດທິບັດ ແລະ ອະນຸສິດທິບັດ (Patent and Petty Patent)

2. ຜົນການອອກສິດທິບັດ ແລະ ອະນຸສິດທິບັດ (Grant of Patents and Petty Patents)

ຄຳອະທິບາຍກ່ຽວກັບລະຫັດຫຍໍ້

(Introduction of Codes)

- (11) ເລກທິ (Grant Number)
- (21) ເລກທິ ຄຳຮ້ອງ (Filing Number)
- (22) ວັນທິຍືນຄຳຮ້ອງ (Filing Date)
- (30) ວັນທິ ບຸລິມະສິດ (Priority Date)
- (43) ວັນທິເຜີຍແຜ່ (Publication Date)
- (51) ໝວດ (International Patent Classification)
- (54) ຫົວຂໍ້ການປະດິດ (Title)
- (57) ບົດຄັດຫຍໍ້ (Abstract)
- (71) ຊື່ ແລະ ທີ່ຢູ່ ເຈົ້າຂອງສິດທິບັດ ແລະ ອະນຸສິດທິບັດ (Owner Name and Address)
- (72) ຊື່ຜູ້ປະດິດ (Inventor Name)
- (74) ຊື່ຕົວແທນ (Representative Name)
- (55) ຮູບພາບ (Pictures)

- (11) No. 396
- (21) PA 396
- (22) 08/10/2015
- (30)
- (43)
- (51) Int.Cl.8E 02B 3/16
- (54) ວິທີການ ແລະ ເຄື່ອງມືທີ່ໃຊ້ໃນການປົກປັດ ແລະ ກັນນໍ້າສໍາຫລັບຂໍ້ຕໍ່ໃນວຽກໄຮໂດລິກ
- (57) ວິທີການ ແລະ ເຄື່ອງມືສໍາລັບການປົກປັດ ແລະ ກັນນໍ້າຂໍ້ຕໍ່ລະຫວ່າງ ຊັ້ນຄອນກຣີດ (12, 14) ໃນວຽກໄຮໂດລິກ ເຊັ່ນ ເຂື່ອນຄອງ ຊ່ອງໄຮໂດລິກ ແລະ ອ່າງເກັບນໍ້າ ແຜ່ນປົກປັດ (17) ທີ່ປະກອບດ້ວຍຊັ້ນກັນນໍ້າທີ່ຍືດຫຍຸ່ນໄດ້ (21) ໃນວັດສະດຸທີ່ເປັນໂຟລິເມີທີ່ຍືດຫຍຸ່ນທີ່ມີມໍລະດູລັດຂອງສະພາບ ຍືດຫຍຸ່ນທໍາອິດ (E1) ແລະ ຊັ້ນເສີມ ຢ່າງໜ້ອຍໜຶ່ງຊັ້ນ (23) ໃນວັດສະດຸສັງເຄາະທີ່ມີມໍລະດູລັດຂອງສະພາບຍືດຫຍຸ່ນຮອງ (E2) ຊຶ່ງມີຂະໜາດໃຫຍ່ ກວ່າມໍລະດູລັດຮູບຍືດຫຍຸ່ນທໍາອິດ (E1) ເພື່ອຈໍາກັດການຜິດຮູບຂອງແຜ່ນຍືດທີ່ບໍ່ສາມາດຊຶມຜ່ານໄດ້ (21), ຢູ່ຄ່ອມລະຫວ່າງຊັ້ນຄອນກຣີດທີ່ຢູ່ອີກດ້ານ (12, 14) ຕົວຢ່າງເຊັ່ນ ໃນຂໍ້ຕໍ່ແບບຕົງແລະ/ຫຼື ຂໍ້ຕໍ່ແບບແນວຍາວ ໃນວຽກໄຮໂດລິກຊັ້ນເສີມ (23) ແລະເຍື້ອທີ່ກັນນໍ້າ (21) ຈະຜັບຕາມຂວາງເປັນວົງ ແລະ ວາງພາຍໃນແລະ/ຫຼື ພາຍນອກຂໍ້ຕໍ່ທີ່ຮັດກັບແຜ່ນປົກປັດ (17) ເຂົ້າກັບຊັ້ນຄອນກຣີດ (12, 14) ລວມຖືງຂອບຂອງມັນດ້ວຍ ການເຄື່ອນລະຫວ່າງຊັ້ນຄອນກຣີດ (12, 14) ຂອງຂໍ້ຕໍ່ (16) ຈະທົດແທນດ້ວຍການຍືດຂະຫຍາຍຂອງແຜ່ນປົກປັດທີ່ຜັບຢູ່ໂດຍບໍ່ມີຂໍ້ຈໍາກັດ (17).
- (71) CARPI TECH B.V
Spoorhaven 88, NL-2651 AV Berkel en Rodenrijs, the Netherland., The Netherlands.
- (72) SCUERO ALBERTO MARIA.
- (74) Tilleke & Gibbins Lao Co., Ltd..
- (55)

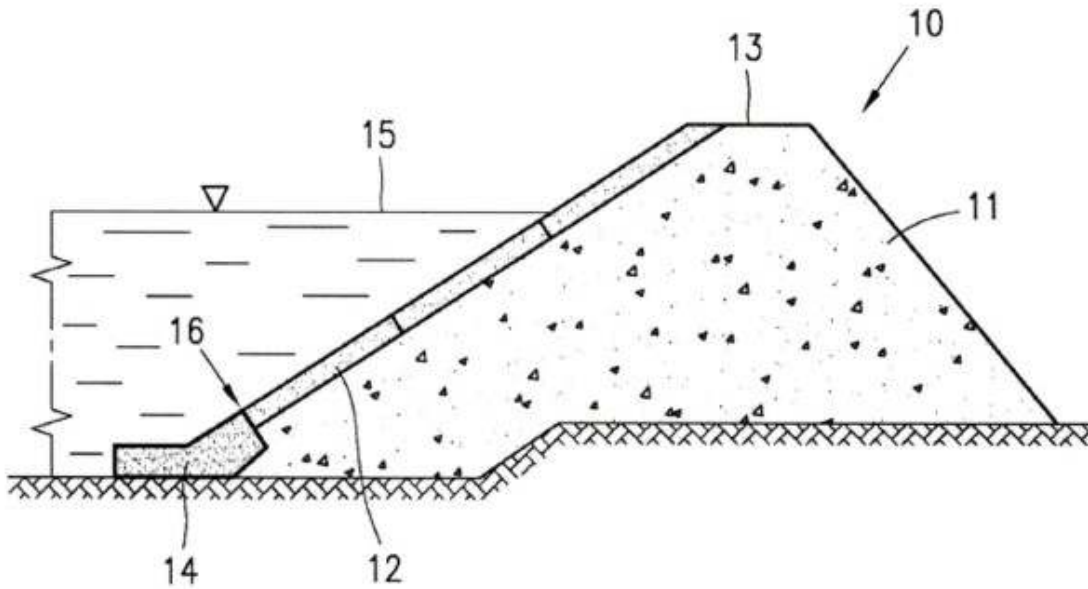

ຮູບທີ່ 1

ພາກທີ I

(Part I)

ສິດທິບັດ ແລະ ອະນຸສິດທິບັດ

(Patent and Petty Patent)

3. ການປ່ຽນແປງ

(Changes)

ພາກທີ I

(Part I)

ສິດທິບັດ ແລະ ອະນຸສິດທິບັດ

(Patent and Petty Patent)

4. ການດັດແກ້

(Amendments)

ພາກທີ II
(Part II)
ແບບອຸດສາຫະກຳ
(Industrial Design)

1. ຄຳຮ້ອງ
(Applications)

ຄຳອະທິບາຍກ່ຽວກັບລະຫັດຫຍໍ້
(Introduction of Codes)

- (21) ເລກທີ ຄຳຮ້ອງ (Filing Number)
(22) ວັນທີ ຄຳຮ້ອງ (Filing Date)
(30) ວັນທີ ບຸລິມາສິດ (Priority Date)
(51) ໝວດ (Locarno Classification)
(54) ຊື່ຂອງແບບອຸດສາຫະກຳ (Title)
(71) ຊື່ ແລະ ທີ່ຢູ່ ຂອງເຈົ້າຂອງ (Owner Name and Address)
(72) ຊື່ຜູ້ອອກແບບ (Designer Name)
(74) ຊື່ຕົວແທນ (Representative Name)
(55) ຮູບພາບ (Pictures)

ພາກທີ II
(Part II)
ແບບອຸດສາຫະກຳ
(Industrial Design)

2. ຜົນການຈົດທະບຽນ
(Registration)

ຄຳອະທິບາຍກ່ຽວກັບລະຫັດຫຍໍ້
(Introduction of Codes)

- (11) ເລກທີ ຈົດທະບຽນ (Registration Number)
(15) ວັນທີ ຈົດທະບຽນ (Registration Date)
(21) ເລກທີ ຍືນຄຳຮ້ອງ (Filing Number)
(22) ວັນທີ ຍືນຄຳຮ້ອງ (Filing Date)
(30) ວັນທີ ບຸລິມາສິດ (Priority Date)
(17) ວັນທີ ໝົດອາຍຸ (Expiration Date)
(51) ໝວດ (Locarno Classification)
(54) ຊື່ຂອງແບບອຸດສາຫະກຳ (Title)
(71) ຊື່ ແລະ ທີ່ຢູ່ ຂອງເຈົ້າຂອງ (Owner Name and Address)
(72) ຊື່ຜູ້ອອກແບບ (Designer Name)
(74) ຊື່ຕົວແທນ (Representative Name)
(55) ຮູບພາບ (Pictures)

ພາກທີ II

(Part II)

ແບບອຸດສາຫະກຳ

(Industrial Design)

3. ການປ່ຽນແປງ

(Changes)

ພາກທີ II

(Part II)

ແບບອຸດສາຫະກຳ

(Industrial Design)

4. ການດັດແກ້

(Amendments)

ພາກທີ III
(Part III)
ເຄື່ອງໝາຍການຄ້າ
Trademarks

1. ຄໍາຮ້ອງ
(Applications)

ຄໍາອະທິບາຍກ່ຽວກັບລະຫັດຫຍໍ້
(Introduction of Codes)

- (540) ເຄື່ອງໝາຍການຄ້າ (Trademark)
- (511) ໝວດ (Nice Classification)
- (210) ເລກທີ ຄໍາຮ້ອງ (Number of the application)
- (220) ວັນທີ ຄໍາຮ້ອງ (Date of filing of the application)
- (732) ຊື່ ແລະ ທີ່ຢູ່ ຂອງຜູ້ຍື່ນຄໍາຮ້ອງ (Name and Address of applicant)

(540) Trademark Application

ອາຍເຍາ

(511) 12

(210) No. 49459

(220) 12/12/2023

(732) ບໍລິສັດ ອາຍເຍາ ຂາອອກ - ຂາເຂົ້າ ຈຳກັດຜູ້ດຽວ
ບ້ານ ຫ້ວຍຫົງ, ເມືອງ ໄຊທານີ, ນະຄອນຫຼວງວຽງຈັນ,
ສປປ ລາວ

ພາກທີ III

(Part III)

ເຄື່ອງໝາຍການຄ້າ

Trademarks

2. ຜົນການຈົດທະບຽນ

(Registration)

ຄຳອະທິບາຍກ່ຽວກັບລະຫັດຫຍໍ້

(Introduction of Codes)

- (540) ເຄື່ອງໝາຍການຄ້າ (Trademark)
- (511) ໝວດ (Nice Classification)
- (210) ເລກທີ ຄຳຮ້ອງ (Number of the application)
- (220) ວັນທີ ຄຳຮ້ອງ (Date of filing of the application)
- (732) ຊື່ ແລະ ທີ່ຢູ່ ຂອງຜູ້ຍື່ນຄຳຮ້ອງ (Name and Address of applicant)
- (111) ເລກທີ ການຈົດທະບຽນເຄື່ອງໝາຍການຄ້າ (Number of the registration)
- (180) ວັນໝົດອາຍຸຂອງການຈົດທະບຽນ (Expiration date of the registration)

(540) Registration

(511) 33

(210) No. 49306

(220) 17/11/2023

(732) PHOENIX SYNDICATE (THAILAND)
COMPANY LIMITED

899/57 Soi Sukhumvit 101 Bang Chak,
Phra Khanong, Bangkok 10260, Thailand

(111) No. 61757

(180) 17/11/2033

(540) Registration

(511) 16, 35, 41, 42 and 45

(210) No. 49215

(220) 01/11/2023

(732) Tilleke & Gibbins International Ltd.

No. 1011, Supalai Grand Tower, 20th-26th
Floor, Rama 3 Road, Chongnonsi
Subdistrict, Yannawa District, 10120,
Bangkok, Thailand

(111) No. 61758

(180) 01/11/2033

(540) Registration

KRYTOX

(511) 04

(210) No. 49216

(220) 01/11/2023

(732) The Chemours Company FC, LLC

1007 Market Street, Wilmington, Delaware,
19899, United States Of America

(111) No. 61759

(180) 01/11/2033

(540) Registration

茂隆酱园
Maolong

(511) 29 and 30

(210) No. 49303

(220) 17/11/2023

(732) MAOLUNG JIANGYUAN FOOD CO.,
LTD.

No. 889, East Gaoming Avenue, Sanzhou,
Hecheng, Gaoming, Foshan, Guangdong,
China

(111) No. 61760

(180) 17/11/2033

(540) Registration

VEDA TINDA

(511) 03

(210) No. 49304

(220) 17/11/2023

(732) GUANGZHOU BENYUAN

INFORMATION TECHNOLOGY CO.,
LTD.

Room 409, Building 7, No. 63, Huangbian
North Road, Baiyun District, Guangzhou,
Guangdong, China

(111) No. 61761

(180) 17/11/2033

(540) Registration



(511) 35

(210) No. 49305

(220) 17/11/2023

(732) ITEL TECHNOLOGY LIMITED

Flat N, 16/F, Block B, Universal Industrial
Centre, 19-25 Shan Mei Street, Fotan, NT,
Hong Kong

(111) No. 61762

(180) 17/11/2033

(540) Registration



(511) 05 and 31

(210) No. 49230

(220) 03/11/2023

(732) GREENFEED VIETNAM CORPORATION

Nhut Chanh Commune, Ben Luc District,

Long An Province, Vietnam

(111) No. 61763

(180) 03/11/2033

(540) Registration



(511) 43

(210) No. 49232

(220) 06/11/2023

(732) GUANGZHOU SHENGFA CATERING

CO., LTD.

Room 103, No. 113, Changxing Road, Tianhe

District, Guangzhou City, Guangdong

Province, China

(111) No. 61764

(180) 06/11/2033

(540) Registration



(511) 06

(210) No. 49235

(220) 08/11/2023

(732) Dai Dung Metallic Manufacture Construction
and Trade Corporation

Lot 38, Zone C, D1 Street, An Ha Industrial
Park, Pham Van Hai Commune, Binh Chanh
District, Ho Chi Minh City, Vietnam

(111) No. 61765

(180) 08/11/2033

(540) Registration



(511) 09

(210) No. 49236

(220) 08/11/2023

(732) NGUYEN PHAN THANG

300/34/64 Nguyen Van Linh, Quarter 4, Binh
Thuan Ward, District 7, Ho Chi Minh City,
Vietnam

(111) No. 61766

(180) 08/11/2033

(540) Registration

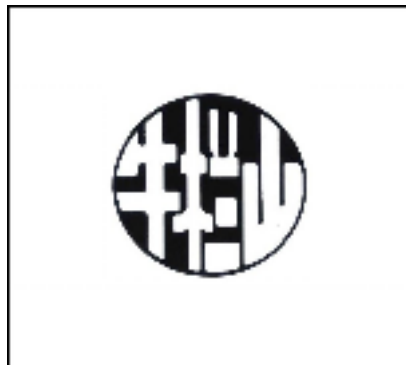

(511) 33

(210) No. 49238

(220) 09/11/2023

(732) Beijing Shunxin Agriculture Co., Ltd.

Niulanshan Winery

East of Office, Niushan Area, Shunyi

District, Beijing, China

(111) No. 61767

(180) 09/11/2033

(540) Registration



(511) 07, 12 and 35

(210) No. 49240

(220) 09/11/2023

(732) Siam Kubota Corporation Co., Ltd.

101/19-24 Moo 20, Navanakorn Industrial

Estate, Klongneung sub-district, Klongluang

district, Pathumtani, Thailand

(111) No. 61768

(180) 09/11/2033

(540) Registration

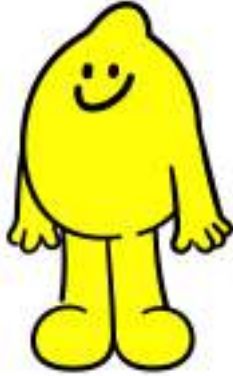

(511) 03, 09, 16, 18, 21, 25, 28, 35, 38, 41, 42 and 45

(210) No. 49242

(220) 09/11/2023

(732) Lemon Inc.

P.O. Box 31119 Grand Pavilion, Hibiscus
Way, 802 West Bay Road, Grand Cayman,
KY1-1205, Cayman Islands

(111) No. 61769

(180) 09/11/2033

(540) Registration



(511) 03, 09, 16, 18, 21, 25, 28, 35, 38, 41, 42 and 45

(210) No. 49243

(220) 09/11/2023

(732) Lemon Inc.

P.O. Box 31119 Grand Pavilion, Hibiscus
Way, 802 West Bay Road, Grand Cayman,
KY1-1205, Cayman Islands

(111) No. 61770

(180) 09/11/2033

(540) Registration



นมแม่

(511) 05 and 29

(210) No. 49246

(220) 10/11/2023

(732) Société des Produits Nestlé S.A.

1800 Vevey, Switzerland

(111) No. 61771

(180) 10/11/2033

(540) Registration



นมแม่

(511) 05 and 29

(210) No. 49247

(220) 10/11/2023

(732) Société des Produits Nestlé S.A.

1800 Vevey, Switzerland

(111) No. 61772

(180) 10/11/2033

(540) Registration

LACTOGROW

(511) 05 and 29

(210) No. 49248

(220) 10/11/2023

(732) Société des Produits Nestlé S.A.

1800 Vevey, Switzerland

(111) No. 61773

(180) 10/11/2033

(540) Registration

KLONG

(511) 07

(210) No. 49250

(220) 10/11/2023

(732) HANGZHOU KUAIZHUN AUTO PARTS

E-BUSINESS CO.,LTD

Room 1503-1504, Building 3, Haichuang

Science and Technology Center, Cangqian

Street, Yuhang District, Hangzhou City,

Zhejiang Province, China

(111) No. 61774

(180) 10/11/2033

(540) Registration

Kbase

(511) 12 and 17

(210) No. 49252

(220) 10/11/2023

(732) HANGZHOU KUAIZHUN AUTO PARTS

E-BUSINESS CO.,LTD

Room 1503-1504, Building 3, Haichuang

Science and Technology Center, Cangqian

Street, Yuhang District, Hangzhou City,

Zhejiang Province, China

(111) No. 61775

(180) 10/11/2033

(540) Registration

VIC EAGLE

(511) 04

(210) No. 49253

(220) 10/11/2023

(732) HANGZHOU KUAIZHUN AUTO PARTS

E-BUSINESS CO.,LTD

Room 1503-1504, Building 3, Haichuang

Science and Technology Center, Cangqian

Street, Yuhang District, Hangzhou City,

Zhejiang Province, China

(111) No. 61776

(180) 10/11/2033

(540) Registration

Coburo

(511) 01

(210) No. 49254

(220) 10/11/2023

(732) HANGZHOU KUAIZHUN AUTO PARTS

E-BUSINESS CO.,LTD

Room 1503-1504, Building 3, Haichuang

Science and Technology Center, Cangqian

Street, Yuhang District, Hangzhou City,

Zhejiang Province, China

(111) No. 61777

(180) 10/11/2033

(540) Registration

Q-CLEAN P+

(511) 12

(210) No. 49255

(220) 10/11/2023

(732) HANGZHOU KUAIZHUN AUTO PARTS

E-BUSINESS CO.,LTD

Room 1503-1504, Building 3, Haichuang

Science and Technology Center, Cangqian

Street, Yuhang District, Hangzhou City,

Zhejiang Province, China

(111) No. 61778

(180) 10/11/2033

(540) Registration

K-Leopard

(511) 09

(210) No. 49256

(220) 10/11/2023

(732) HANGZHOU KUAIZHUN AUTO PARTS

E-BUSINESS CO.,LTD

Room 1503-1504, Building 3, Haichuang

Science and Technology Center, Cangqian

Street, Yuhang district, Hangzhou City,

Zhejiang Province, China

(111) No. 61779

(180) 10/11/2033

(540) Registration

KZWON

(511) 07 and 12

(210) No. 49257

(220) 10/11/2023

(732) HANGZHOU KUAIZHUN AUTO PARTS

E-BUSINESS CO.,LTD

Room 1503-1504, Building 3, Haichuang

Science and Technology Center, Cangqian

Street, Yuhang District, Hangzhou City,

Zhejiang Province, China

(111) No. 61780

(180) 10/11/2033

(540) Registration



(511) 09

(210) No. 49259

(220) 10/11/2023

(732) Gokin Solar Co., Ltd.

Unit B25, 2 / F, Building 4, 153 Rongao
Road, Hengqin New District, Zhuhai City,
Guangdong Province, 519000, China

(111) No. 61781

(180) 10/11/2033

(540) Registration



(511) 34

(210) No. 49264

(220) 13/11/2023

(732) TAN KHER WEI

No. 65-2, 506, wanghai Road, Software Park
2, Siming District, Xiamen City, Fujian
Province 361000, China

(111) No. 61782

(180) 13/11/2033

(540) Registration

smartdaili

(511) 42

(210) No. 49265

(220) 13/11/2023

(732) SHANGHAI SHENG JUN INFORMATION
TECHNOLOGY LTD.

58 Bu Zhen Nan Rd., Bu Zhen, Chong Ming
Dist., Shanghai, China

(111) No. 61783

(180) 13/11/2033

(540) Registration

smartdaili

(511) 38

(210) No. 49266

(220) 13/11/2023

(732) SHANGHAI SHENG JUN INFORMATION
TECHNOLOGY LTD.

58 Bu Zhen Nan Rd., Bu Zhen, Chong Ming
Dist., Shanghai, China

(111) No. 61784

(180) 13/11/2033

(540) Registration

smartdaili

(511) 09

(210) No. 49267

(220) 13/11/2023

(732) SHANGHAI SHENG JUN INFORMATION
TECHNOLOGY LTD.

58 Bu Zhen Nan Rd., Bu Zhen, Chong Ming
Dist., Shanghai, China

(111) No. 61785

(180) 13/11/2033

(540) Registration

**UNLEASH THE
BEAST!**

(511) 32

(210) No. 49271

(220) 14/11/2023

(732) Monster Energy Company

1 Monster Way, Corona, California 92879,
United States Of America

(111) No. 61786

(180) 14/11/2033

(540) Registration

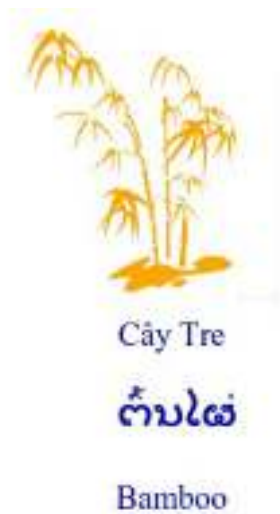

(511) 30

(210) No. 49274

(220) 14/11/2023

(732) VIMAFLOUR LTD

Cai Lan Industrial Zone, Ha Long City,
Quang Ninh Province, Vietnam

(111) No. 61787

(180) 14/11/2033

(540) Registration



(511) 29

(210) No. 49276

(220) 15/11/2023

(732) Samyang Foods Co., Ltd

104, Opaesan-ro 3-gil, Seongbuk-gu, Seoul,
02737, Republic Of Korea

(111) No. 61788

(180) 15/11/2033

(540) Registration



(511) 03 and 21

(210) No. 49279

(220) 15/11/2023

(732) LION CORPORATION

1-3-28 Kuramae, Taito-ku, 111-8644, Tokyo,
Japan

(111) No. 61789

(180) 15/11/2033

(540) Registration



(511) 03 and 21

(210) No. 49280

(220) 15/11/2023

(732) LION CORPORATION

1-3-28 Kuramae, Taito-ku, 111-8644, Tokyo ,
Japan

(111) No. 61790

(180) 15/11/2033

(540) Registration

TOUS *les* JOURS

(511) 09

(210) No. 49307

(220) 17/11/2023

(732) CJ FOODVILLE CORP.

34, Mareunnae-ro, Jung-gu, Seoul,

Republic Of Korea

(111) No. 61791

(180) 17/11/2033

(540) Registration

TOUS *les* JOURS

(511) 29

(210) No. 49308

(220) 17/11/2023

(732) CJ FOODVILLE CORP.

34, Mareunnae-ro, Jung-gu, Seoul,

Republic Of Korea

(111) No. 61792

(180) 17/11/2033

(540) Registration

TOUS *les* JOURS

(511) 30

(210) No. 49309

(220) 17/11/2023

(732) CJ FOODVILLE CORP.

34, Mareunnae-ro, Jung-gu, Seoul,
Republic Of Korea

(111) No. 61793

(180) 17/11/2033

(540) Registration

TOUS *les* JOURS

(511) 31

(210) No. 49310

(220) 17/11/2023

(732) CJ FOODVILLE CORP.

34, Mareunnae-ro, Jung-gu, Seoul,
Republic Of Korea

(111) No. 61794

(180) 17/11/2033

(540) Registration

TOUS *les* JOURS

(511) 35

(210) No. 49311

(220) 17/11/2023

(732) CJ FOODVILLE CORP.

34, Mareunnae-ro, Jung-gu, Seoul,
Republic Of Korea

(111) No. 61795

(180) 17/11/2033

(540) Registration

TOUS *les* JOURS

(511) 43

(210) No. 49312

(220) 17/11/2023

(732) CJ FOODVILLE CORP.

34, Mareunnae-ro, Jung-gu, Seoul,
Republic Of Korea

(111) No. 61796

(180) 17/11/2033

(540) Registration



(511) 09

(210) No. 49313

(220) 17/11/2023

(732) CJ FOODVILLE CORP.

34, Mareunnae-ro, Jung-gu, Seoul,
Republic Of Korea

(111) No. 61797

(180) 17/11/2033

(540) Registration



(511) 29

(210) No. 49314

(220) 17/11/2023

(732) CJ FOODVILLE CORP.

34, Mareunnae-ro, Jung-gu, Seoul,
Republic Of Korea

(111) No. 61798

(180) 17/11/2033

(540) Registration



(511) 30

(210) No. 49315

(220) 17/11/2023

(732) CJ FOODVILLE CORP.

34, Mareunnae-ro, Jung-gu, Seoul,
Republic Of Korea

(111) No. 61799

(180) 17/11/2033

(540) Registration



(511) 31

(210) No. 49316

(220) 17/11/2023

(732) CJ FOODVILLE CORP.

34, Mareunnae-ro, Jung-gu, Seoul,
Republic Of Korea

(111) No. 61800

(180) 17/11/2033

(540) Registration



(511) 35

(210) No. 49317

(220) 17/11/2023

(732) CJ FOODVILLE CORP.

34, Mareunnae-ro, Jung-gu, Seoul,
Republic Of Korea

(111) No. 61801

(180) 17/11/2033

(540) Registration



(511) 43

(210) No. 49318

(220) 17/11/2023

(732) CJ FOODVILLE CORP.

34, Mareunnae-ro, Jung-gu, Seoul,
Republic Of Korea

(111) No. 61802

(180) 17/11/2033

(540) Registration

江边城外 烤全鱼
RIVERSIDE GRILLED FISH

(511) 43

(210) No. 49319

(220) 20/11/2023

(732) Beijing Riverside & Courtyard Investment
Management Co., Ltd.

Room 4061, 4/F Building 8 Weibohao Home,
No.1 Weigongcun Street, Haidian district,
Beijing, China

(111) No. 61803

(180) 20/11/2033

(540) Registration

HOO

(511) 09, 34 and 35

(210) No. 49322

(220) 20/11/2023

(732) SHANGHAI TOBACCO GROUP CO., LTD.

717 Chang Yang Road, Yangpu District,
Shanghai, China

(111) No. 61804

(180) 20/11/2033

(540) Registration

SWICH OH BOY

(511) 30

(210) No. 49323

(220) 20/11/2023

(732) INTERNATIONAL FOODSTUFFS CO. LLC

Al-Wahda Street, Industrial Area No.1, P.O.

Box No.4115, Sharjah, United Arab Emirates

(111) No. 61805

(180) 20/11/2033

(540) Registration



(511) 06, 07, 09, 12, 14 and 16

(210) No. 49324

(220) 21/11/2023

(732) China Railway Kunming Group Co., Ltd.

No. 548, Tangshuang Road, Nanzhanxincun,

Kunming City, Yunnan Province, China

(111) No. 61806

(180) 21/11/2033

(540) Registration



(511) 33

(210) No. 49325

(220) 21/11/2023

(732) Guizhou Guijiu Co., Ltd.

Longchang Town, Xiuwen County, Guiyang
City Guizhou Province, China

(111) No. 61807

(180) 21/11/2033

(540) Registration



(511) 33

(210) No. 49326

(220) 21/11/2023

(732) Guizhou Guijiu Co., Ltd.

Longchang Town, Xiuwen County, Guiyang
City Guizhou Province, China

(111) No. 61808

(180) 21/11/2033

(540) Registration



(511) 18, 20, 21, 22, 25 and 35

(210) No. 49327

(220) 21/11/2023

(732) China Railway Kunming Group Co., Ltd.
No. 548, Tangshuang Road, Nanzhanxincun,
Kunming City, Yunnan Province, China

(111) No. 61809

(180) 21/11/2033

(540) Registration



(511) 36, 38, 39, 41, 42 and 45

(210) No. 49328

(220) 21/11/2023

(732) China Railway Kunming Group Co., Ltd.
No. 548, Tangshuang Road, Nanzhanxincun,
Kunming City, Yunnan Province, China

(111) No. 61810

(180) 21/11/2033

(540) Registration

瀾滄快鐵

(511) 06, 07, 09, 12, 14 and 16

(210) No. 49329

(220) 21/11/2023

(732) China Railway Kunming Group Co., Ltd.
No. 548, Tangshuang Road, Nanzhanxincun,
Kunming City, Yunnan Province, China

(111) No. 61811

(180) 21/11/2033

(540) Registration

瀾滄快鐵

(511) 18, 20, 21, 22, 25 and 35

(210) No. 49330

(220) 21/11/2023

(732) China Railway Kunming Group Co., Ltd.
No. 548, Tangshuang Road, Nanzhanxincun,
Kunming City, Yunnan Province, China

(111) No. 61812

(180) 21/11/2033

(540) Registration

澜滯快鐵

(511) 36, 38, 39, 41, 42 and 45

(210) No. 49331

(220) 21/11/2023

(732) China Railway Kunming Group Co., Ltd.
No. 548, Tangshuang Road, Nanzhanxincun,
Kunming City, Yunnan Province, China

(111) No. 61813

(180) 21/11/2033

(540) Registration

澜滯快鐵

(511) 06, 07, 09, 12, 14 and 16

(210) No. 49332

(220) 21/11/2023

(732) China Railway Kunming Group Co., Ltd.
No. 548, Tangshuang Road, Nanzhanxincun,
Kunming City, Yunnan Province, China

(111) No. 61814

(180) 21/11/2033

(540) Registration

昆明铁路集团

(511) 18, 20, 21, 22, 25 and 35

(210) No. 49333

(220) 21/11/2023

(732) China Railway Kunming Group Co., Ltd.
No. 548, Tangshuang Road, Nanzhanxincun,
Kunming City, Yunnan Province, China

(111) No. 61815

(180) 21/11/2033

(540) Registration

贵酒

(511) 33

(210) No. 49334

(220) 21/11/2023

(732) Guizhou Guijiu Co., Ltd.
Longchang Town, Xiuwen County, Guiyang
City Guizhou Province, China

(111) No. 61816

(180) 21/11/2033

(540) Registration

昆明铁路局

(511) 36, 38, 39, 41, 42 and 45

(210) No. 49335

(220) 21/11/2023

(732) China Railway Kunming Group Co., Ltd.
No. 548, Tangshuang Road, Nanzhanxincun,
Kunming City, Yunnan Province, China

(111) No. 61817

(180) 21/11/2033

(540) Registration

GUIJIU

(511) 33

(210) No. 49336

(220) 21/11/2023

(732) Guizhou Guijiu Co., Ltd.
Longchang Town, Xiuwen County, Guiyang
City Guizhou Province, China

(111) No. 61818

(180) 21/11/2033

(540) Registration

The logo for "City Fresh" features the word "City" in a bold, sans-serif font above the word "Fresh" in a larger, bolder, sans-serif font. Both words are in black.

(511) 29, 30, 31 and 43

(210) No. 49337

(220) 21/11/2023

(732) CITY FRESH FRUIT CO., LTD.

8 Karnchanapisek Road, Klong Bangbon,
Bangbon, Bangkok 10150, Thailand

(111) No. 61819

(180) 21/11/2033

(540) Registration

The logo for "TOPTEN" features the word "TOPTEN" in a bold, sans-serif font. The letter "O" is stylized with a circular pattern inside it. The entire logo is in black.

(511) 18

(210) No. 49340

(220) 22/11/2023

(732) SHINSUNG TONGSANG CO., LTD.

444 Dunchon-dong, Gangdong-ku, Seoul,
Republic Of Korea

(111) No. 61820

(180) 22/11/2033

(540) Registration



(511) 25

(210) No. 49341

(220) 22/11/2023

(732) SHINSUNG TONGSANG CO., LTD.

444 Dunchon-dong, Gangdong-ku, Seoul,
Republic Of Korea

(111) No. 61821

(180) 22/11/2033

(540) Registration



(511) 35

(210) No. 49342

(220) 22/11/2023

(732) SHINSUNG TONGSANG CO., LTD.

444 Dunchon-dong, Gangdong-ku, Seoul,
Republic Of Korea

(111) No. 61822

(180) 22/11/2033

(540) Registration

MR BLACK

(511) 33

(210) No. 49343

(220) 22/11/2023

(732) DIAGEO NORTH AMERICA, INC.

3 World Trade Center 175 Greenwich

Street New York, NY 10007,

United States Of America

(111) No. 61823

(180) 22/11/2033

(540) Registration



WEDRINK

(511) 29 and 43

(210) No. 49356

(220) 23/11/2023

(732) ZHENGZHOU RUNXIANG CATERING

MANAGEMENT CO., LTD.

Room 62, 14th Floor, Building 5, No.218

Xinzheng Road, Guancheng District,

Zhengzhou, Henan Province, China

(111) No. 61824

(180) 23/11/2033

(540) Registration

RONTAMIL

(511) 05

(210) No. 49357

(220) 23/11/2023

(732) DREAVIA AG

BAHNHOFSTRASSE 7, CH 6300 ZUG,
SWITZERLAND

(111) No. 61825

(180) 23/11/2033

(540) Registration

RONTAMEAL

(511) 05, 29, 30 and 32

(210) No. 49358

(220) 23/11/2023

(732) DREAVIA AG

BAHNHOFSTRASSE 7, CH 6300 ZUG,
SWITZERLAND

(111) No. 61826

(180) 23/11/2033

(540) Registration



(511) 30

(210) No. 49359

(220) 23/11/2023

(732) CALLETON (GROUP) CO., LTD

No.366 Houcuo, Qiancuo Village, Haicheng
Town, Longhai District, Zhangzhou City,
Fujian Province, China

(111) No. 61827

(180) 23/11/2033

(540) Registration

DAY BREAK

(511) 30

(210) No. 49361

(220) 24/11/2023

(732) INTERNATIONAL FOODSTUFFS CO. LLC

Al-Wahda Street, Industrial Area No.1, P.O.
Box No.4115, Sharjah, United Arab Emirates

(111) No. 61828

(180) 24/11/2033

(540) Registration

BREAKSTA

(511) 30

(210) No. 49363

(220) 24/11/2023

(732) INTERNATIONAL FOODSTUFFS CO. LLC

Al-Wahda Street, Industrial Area No.1, P.O.

Box No.4115, Sharjah, United Arab Emirates

(111) No. 61829

(180) 24/11/2033

(540) Registration

**QUANTA
BREAKTIME**

(511) 30

(210) No. 49364

(220) 24/11/2023

(732) INTERNATIONAL FOODSTUFFS CO. LLC

Al-Wahda Street, Industrial Area No.1, P.O.

Box No.4115, Sharjah, United Arab Emirates

(111) No. 61830

(180) 24/11/2033

(540) Registration

BREAK RIZZO

(511) 30

(210) No. 49365

(220) 24/11/2023

(732) INTERNATIONAL FOODSTUFFS CO. LLC

Al-Wahda Street, Industrial Area No.1, P.O.

Box No.4115, Sharjah, United Arab Emirates

(111) No. 61831

(180) 24/11/2033

(540) Registration

BREAK DELIGHTS

(511) 30

(210) No. 49366

(220) 24/11/2023

(732) INTERNATIONAL FOODSTUFFS CO. LLC

Al-Wahda Street, Industrial Area No.1, P.O.

Box No.4115, Sharjah, United Arab Emirates

(111) No. 61832

(180) 24/11/2033

(540) Registration

BREAK SUPA

(511) 30

(210) No. 49367

(220) 24/11/2023

(732) INTERNATIONAL FOODSTUFFS CO. LLC

Al-Wahda Street, Industrial Area No.1, P.O.

Box No.4115, Sharjah, United Arab Emirates

(111) No. 61833

(180) 24/11/2033

(540) Registration

BIG BREAK

(511) 30

(210) No. 49368

(220) 24/11/2023

(732) INTERNATIONAL FOODSTUFFS CO. LLC

Al-Wahda Street, Industrial Area No.1, P.O.

Box No.4115, Sharjah, United Arab Emirates

(111) No. 61834

(180) 24/11/2033

(540) Registration

HANKO

(511) 30

(210) No. 49369

(220) 24/11/2023

(732) INTERNATIONAL FOODSTUFFS CO. LLC

Al-Wahda Street, Industrial Area No.1, P.O.

Box No.4115, Sharjah, United Arab Emirates

(111) No. 61835

(180) 24/11/2033

(540) Registration

ROXTA

(511) 30

(210) No. 49370

(220) 24/11/2023

(732) INTERNATIONAL FOODSTUFFS CO. LLC

Al-Wahda Street, Industrial Area No.1, P.O.

Box No.4115, Sharjah, United Arab Emirates

(111) No. 61836

(180) 24/11/2033

(540) Registration

RICCO

(511) 30

(210) No. 49371

(220) 24/11/2023

(732) INTERNATIONAL FOODSTUFFS CO. LLC

Al-Wahda Street, Industrial Area No.1, P.O.

Box No.4115, Sharjah, United Arab Emirates

(111) No. 61837

(180) 24/11/2033

(540) Registration

TEAM UP

(511) 30

(210) No. 49372

(220) 24/11/2023

(732) INTERNATIONAL FOODSTUFFS CO. LLC

Al-Wahda Street, Industrial Area No.1, P.O.

Box No.4115, Sharjah, United Arab Emirates

(111) No. 61838

(180) 24/11/2033

(540) Registration

BRIO

(511) 30

(210) No. 49373

(220) 24/11/2023

(732) INTERNATIONAL FOODSTUFFS CO. LLC

Al-Wahda Street, Industrial Area No.1, P.O.

Box No.4115, Sharjah, United Arab Emirates

(111) No. 61839

(180) 24/11/2033

(540) Registration

HAPPY BREAK

(511) 30

(210) No. 49374

(220) 24/11/2023

(732) INTERNATIONAL FOODSTUFFS CO. LLC

Al-Wahda Street, Industrial Area No.1, P.O.

Box No.4115, Sharjah, United Arab Emirates

(111) No. 61840

(180) 24/11/2033

(540) Registration

GONUTS

(511) 30

(210) No. 49375

(220) 24/11/2023

(732) INTERNATIONAL FOODSTUFFS CO. LLC

Al-Wahda Street, Industrial Area No.1, P.O.

Box No.4115, Sharjah, United Arab Emirates

(111) No. 61841

(180) 24/11/2033

(540) Registration

SPADA

(511) 30

(210) No. 49376

(220) 24/11/2023

(732) INTERNATIONAL FOODSTUFFS CO. LLC

Al-Wahda Street, Industrial Area No.1, P.O.

Box No.4115, Sharjah, United Arab Emirates

(111) No. 61842

(180) 24/11/2033

(540) Registration

KRAEMER

(511) 30

(210) No. 49377

(220) 24/11/2023

(732) INTERNATIONAL FOODSTUFFS CO. LLC

Al-Wahda Street, Industrial Area No.1, P.O.

Box No.4115, Sharjah, United Arab Emirates

(111) No. 61843

(180) 24/11/2033

(540) Registration

CARAWHEEL

(511) 30

(210) No. 49378

(220) 24/11/2023

(732) INTERNATIONAL FOODSTUFFS CO. LLC

Al-Wahda Street, Industrial Area No.1, P.O.

Box No.4115, Sharjah, United Arab Emirates

(111) No. 61844

(180) 24/11/2033

(540) Registration

FRESCO

(511) 30

(210) No. 49380

(220) 24/11/2023

(732) INTERNATIONAL FOODSTUFFS CO. LLC

Al-Wahda Street, Industrial Area No.1, P.O.

Box No.4115, Sharjah, United Arab Emirates

(111) No. 61845

(180) 24/11/2033

(540) Registration

RUSH

(511) 30

(210) No. 49381

(220) 24/11/2023

(732) INTERNATIONAL FOODSTUFFS CO. LLC

Al-Wahda Street, Industrial Area No.1, P.O.

Box No.4115, Sharjah, United Arab Emirates

(111) No. 61846

(180) 24/11/2033

(540) Registration

SCALA

(511) 30

(210) No. 49382

(220) 24/11/2023

(732) INTERNATIONAL FOODSTUFFS CO. LLC

Al-Wahda Street, Industrial Area No.1, P.O.

Box No.4115, Sharjah, United Arab Emirates

(111) No. 61847

(180) 24/11/2033

(540) Registration

DESIRE

(511) 30

(210) No. 49383

(220) 24/11/2023

(732) INTERNATIONAL FOODSTUFFS CO. LLC

Al-Wahda Street, Industrial Area No.1, P.O.

Box No.4115, Sharjah, United Arab Emirates

(111) No. 61848

(180) 24/11/2033

(540) Registration

WOLFY

(511) 30

(210) No. 49384

(220) 24/11/2023

(732) INTERNATIONAL FOODSTUFFS CO. LLC

Al-Wahda Street, Industrial Area No.1, P.O.

Box No.4115, Sharjah, United Arab Emirates

(111) No. 61849

(180) 24/11/2033

(540) Registration

ALMONDAY

(511) 30

(210) No. 49385

(220) 24/11/2023

(732) INTERNATIONAL FOODSTUFFS CO. LLC

Al-Wahda Street, Industrial Area No.1, P.O.

Box No.4115, Sharjah, United Arab Emirates

(111) No. 61850

(180) 24/11/2033

(540) Registration

MAJESTO

(511) 30

(210) No. 49386

(220) 24/11/2023

(732) INTERNATIONAL FOODSTUFFS CO. LLC

Al-Wahda Street, Industrial Area No.1, P.O.

Box No.4115, Sharjah, United Arab Emirates

(111) No. 61851

(180) 24/11/2033

(540) Registration

IGLOO GOLD BAR

(511) 30

(210) No. 49387

(220) 24/11/2023

(732) INTERNATIONAL FOODSTUFFS CO. LLC

Al-Wahda Street, Industrial Area No.1, P.O.

Box No.4115, Sharjah, United Arab Emirates

(111) No. 61852

(180) 24/11/2033

(540) Registration

WAFEROO

(511) 30

(210) No. 49388

(220) 24/11/2023

(732) INTERNATIONAL FOODSTUFFS CO. LLC

Al-Wahda Street, Industrial Area No.1, P.O.

Box No.4115, Sharjah, United Arab Emirates

(111) No. 61853

(180) 24/11/2033

(540) Registration

ARMADA

(511) 30

(210) No. 49391

(220) 24/11/2023

(732) INTERNATIONAL FOODSTUFFS CO. LLC

Al-Wahda Street, Industrial Area No.1, P.O.

Box No.4115, Sharjah, United Arab Emirates

(111) No. 61854

(180) 24/11/2033

(540) Registration

COMBO

(511) 30

(210) No. 49392

(220) 24/11/2023

(732) INTERNATIONAL FOODSTUFFS CO. LLC

Al-Wahda Street, Industrial Area No.1, P.O.

Box No.4115, Sharjah, United Arab Emirates

(111) No. 61855

(180) 24/11/2033

(540) Registration

PALM BEACH

(511) 30

(210) No. 49393

(220) 25/11/2023

(732) INTERNATIONAL FOODSTUFFS CO. LLC

Al-Wahda Street, Industrial Area No.1, P.O.

Box No.4115, Sharjah, United Arab Emirates

(111) No. 61856

(180) 25/11/2033

(540) Registration

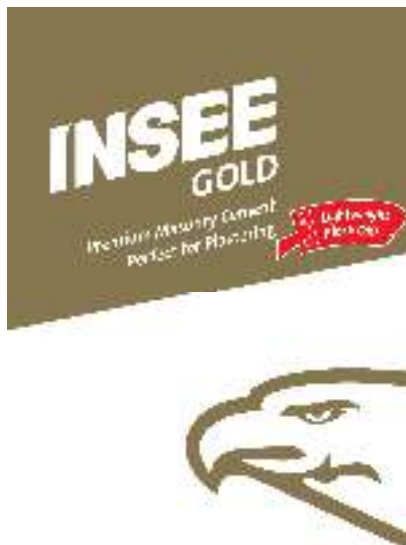

(511) 19

(210) No. 49395

(220) 27/11/2023

(732) Siam City Cement Public Company Limited
199 Column Tower, Ratchadapisek Road,
Klongtoey, Bangkok 10110, Thailand

(111) No. 61857

(180) 27/11/2033

(540) Registration



(511) 19

(210) No. 49396

(220) 27/11/2023

(732) Siam City Cement Public Company Limited
199 Column Tower, Ratchadapisek Road,
Klongtoey, Bangkok 10110, Thailand

(111) No. 61858

(180) 27/11/2033

(540) Registration

biaze

(511) 09

(210) No. 49397

(220) 27/11/2023

(732) Shenzhen Biaze Technology Co., LTD

1501, Building 2 Pengyuan, No. 18, Lilang
Road, Shanglilang Community, Nanwan
Street, Longgang District, Shenzhen, China

(111) No. 61859

(180) 27/11/2033

(540) Registration

PAXA

(511) 09

(210) No. 49398

(220) 28/11/2023

(732) SHANGHAI WEIHONGHANG CULTURE
COMMUNICATION CO., LTD

(Shanghai Hengtai Jingji Kaifa Zone) No.58
Fumin Branch Rd, Hengsha Township,
Chongming, Shanghai, China

(111) No. 61860

(180) 28/11/2033

(540) Registration

QUANTA SQUARES

(511) 30

(210) No. 49399

(220) 28/11/2023

(732) INTERNATIONAL FOODSTUFFS CO. LLC

Al-Wahda Street, Industrial Area No.1, P.O.

Box No.4115, Sharjah, United Arab Emirates

(111) No. 61861

(180) 28/11/2033

(540) Registration



(511) 30

(210) No. 49401

(220) 29/11/2023

(732) T.MAN PHARMACEUTICAL PUBLIC
COMPANY LIMITED

No. 69/1 Soi Bangkhunthian 14, Bangkhutian
Road, Samaedum, Bangkhunthian, Bangkok,
Thailand

(111) No. 61862

(180) 29/11/2033

(540) Registration



(511) 05

(210) No. 49402

(220) 29/11/2023

(732) T.MAN PHARMACEUTICAL PUBLIC
COMPANY LIMITED

No. 69/1 Soi Bangkhunthian 14, Bangkhutian
Road, Samaedum, Bangkhunthian, Bangkok,
Thailand

(111) No. 61863

(180) 29/11/2033

(540) Registration



(511) 03

(210) No. 49403

(220) 29/11/2023

(732) T.MAN PHARMACEUTICAL PUBLIC
COMPANY LIMITED

No. 69/1 Soi Bangkhunthian 14, Bangkhutian
Road, Samaedum, Bangkhunthian, Bangkok,
Thailand

(111) No. 61864

(180) 29/11/2033

(540) Registration



(511) 30

(210) No. 49404

(220) 29/11/2023

(732) INTERNATIONAL FOODSTUFFS CO.
LLC

Al-Wahda Street, Industrial Area No.1, P.O.

Box No.4115, Sharjah, United Arab Emirates

(111) No. 61865

(180) 29/11/2033

(540) Registration



(511) 30

(210) No. 49405

(220) 29/11/2023

(732) INTERNATIONAL FOODSTUFFS CO.
LLC

Al-Wahda Street, Industrial Area No.1, P.O.

Box No.4115, Sharjah, United Arab Emirates

(111) No. 61866

(180) 29/11/2033

(540) Registration



(511) 30

(210) No. 49406

(220) 29/11/2023

(732) INTERNATIONAL FOODSTUFFS CO.
LLC

Al-Wahda Street, Industrial Area No.1, P.O.

Box No.4115, Sharjah, United Arab Emirates

(111) No. 61867

(180) 29/11/2033

(540) Registration

JUICE UP

(511) 32

(210) No. 49407

(220) 29/11/2023

(732) INTERNATIONAL FOODSTUFFS CO. LLC

Al-Wahda Street, Industrial Area No.1, P.O.

Box No.4115, Sharjah, United Arab Emirates

(111) No. 61868

(180) 29/11/2033

(540) Registration

The logo for NEVO consists of the word "NEVO" in a bold, uppercase, sans-serif font. The letters are filled with a dense, stippled or pixelated pattern, giving it a textured, digital appearance.

(511) 12

(210) No. 49408

(220) 29/11/2023

(732) CHONGQING CHANGAN AUTOMOBILE
CO., LTD.

260 Jianxin East Road, Jiangbei District,
Chongqing, China

(111) No. 61869

(180) 29/11/2033

(540) Registration

The logo for LIGUANG features a stylized, bold, black graphic element above the word "LIGUANG" in a bold, uppercase, sans-serif font. The graphic element is a square with a thick border and a central white shape that resembles a stylized letter 'G' or a similar geometric form.

(511) 12

(210) No. 49409

(220) 30/11/2023

(732) ZHEJIANG PROVINCE LIGUANG
MOTORCYCLE FITTINGS CO., LTD.

Li'ao Northern Industry Zone (South of the
Ouhai Stone Market), Ouhai District,
Wenzhou City, Zhejiang Province, China

(111) No. 61870

(180) 30/11/2033

(540) Registration

The logo for 'Dcash' features the word 'Dcash' in a lowercase, sans-serif font. The 'D' is significantly larger and bolder than the other letters, which are in a standard weight.

(511) 03

(210) No. 49410

(220) 01/12/2023

(732) MODERN CASS INTERNATIONAL
COSMETICS CO., LTD.

26 Soi Chalermprakiat R. 9 Soi 30 Yak 12
Dokmai, Pravet, Bangkok 10250, Thailand

(111) No. 61871

(180) 01/12/2033

(540) Registration

The logo for 'WINNING STAR' features the word 'WINNING' in a smaller, uppercase, sans-serif font above the word 'STAR' in a larger, bold, uppercase, sans-serif font. The 'A' in 'STAR' is stylized with a dot above it.

(511) 09, 11 and 21

(210) No. 49413

(220) 04/12/2023

(732) YIWU WINNING STAR SUPPLY CHAIN
MANAGEMENT CO., LTD.

Rm. 1207, No.999 Chouzhou North Road,
Yiwu City, Zhejiang, China

(111) No. 61872

(180) 04/12/2033

(540) Registration



(511) 09

(210) No. 49416

(220) 06/12/2023

(732) Anhui Yingfa Ruineng Technology Co., Ltd
Weisan Road, Jingliu Street, Economic
Development Zone, Tian Chang, Anhui
Province 239300, China

(111) No. 61873

(180) 06/12/2033

(540) Registration

英发
YINGFA

(511) 09

(210) No. 49417

(220) 06/12/2023

(732) Anhui Yingfa Ruineng Technology Co., Ltd
Weisan Road, Jingliu Street, Economic
Development Zone, Tian Chang, Anhui
Province 239300, China

(111) No. 61874

(180) 06/12/2033

(540) Registration



(511) 06 and 12

(210) No. 49425

(220) 06/12/2023

(732) Mr. Lek Pornmukdamanee

271 Lan Luang Road, Wat Sommanat
Subdistrict, Pomprapsattruphai District,
Bangkok, Thailand

(111) No. 61875

(180) 06/12/2033

(540) Registration



(511) 06 and 12

(210) No. 49426

(220) 06/12/2023

(732) Mr. Lek Pornmukdamanee

271 Lan Luang Road, Wat Sommanat
Subdistrict, Pomprapsattruphai District,
Bangkok, Thailand

(111) No. 61876

(180) 06/12/2033

(540) Registration



(511) 06 and 12

(210) No. 49427

(220) 06/12/2023

(732) Mr. Lek Pornmukdamanee

271 Lan Luang Road, Wat Sommanat
Subdistrict, Pomprapsatruphai District,
Bangkok, Thailand

(111) No. 61877

(180) 06/12/2033

(540) Registration



(511) 33

(210) No. 49428

(220) 06/12/2023

(732) GUI YINGGAN

Room 1806, Building 2, Xingguang Huating,
No.103 Jinsha Road, Jinxia Street, Longhu
District, Shantou, Guangdong, 515000, China

(111) No. 61878

(180) 06/12/2033

(540) Registration

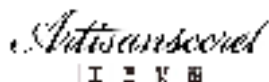

(511) 08, 09 and 11

(210) No. 49429

(220) 06/12/2023

(732) Guangzhou Aihua Electrical Technology Co.,
Ltd.

Room 302, No. 9, Huancun Street, Second
Team, Dongguan Village, Xinya Street,
Huadu District, Guangzhou, China

(111) No. 61879

(180) 06/12/2033

(540) Registration



(511) 32

(210) No. 49430

(220) 06/12/2023

(732) YUNNAN YUXI HUAZHUANG FROZEN
FOOD CO., LTD.

Tuanshan, Taibei Road, Hongta District,
Yuxi City, Yunnan Province, China

(111) No. 61880

(180) 06/12/2033

(540) Registration



(511) 01

(210) No. 49433

(220) 07/12/2023

(732) STANLEY AGRICULTURE GROUP CO.,
LTD.

Shidanli Street, Linshu County, Linyi City,
276700 Shandong Province, China

(111) No. 61881

(180) 07/12/2033

(540) Registration

WAFELLO

(511) 30

(210) No. 49434

(220) 07/12/2023

(732) Elite Gold Ltd.

Portcullis TrustNet Chambers, P.O. Box 3444,
Road Town, Tortola, British Virgin , Islands

(111) No. 61882

(180) 07/12/2033

(540) Registration



(511) 32

(210) No. 49435

(220) 07/12/2023

(732) 7-Eleven International LLC

3200 Hackberry Road, Irving, Texas 75063,
United States Of America

(111) No. 61883

(180) 07/12/2033

(540) Registration



(511) 32

(210) No. 49436

(220) 07/12/2023

(732) 7-Eleven International LLC

3200 Hackberry Road, Irving, Texas 75063,
United States Of America

(111) No. 61884

(180) 07/12/2033

(540) Registration

FAMELINE

(511) 19

(210) No. 49437

(220) 07/12/2023

(732) FAMELINE PRODUCTS CO., LTD.

35/11, Kanchana Phisek Road, Dok Mai

Sub-District, Prawet District, Bangkok

10250, Thailand

(111) No. 61885

(180) 07/12/2033

(540) Registration

FAMELINE

(511) 06

(210) No. 49438

(220) 07/12/2023

(732) FAMELINE PRODUCTS CO., LTD.

35/11, Kanchana Phisek Road, Dok Mai

Sub-District, Prawet District, Bangkok 10250

Thailand

(111) No. 61886

(180) 07/12/2033

(540) Registration



(511) 30

(210) No. 49439

(220) 07/12/2023

(732) LONDON DAIRY COMPANY LIMITED
Analyst House, Po Box 16 20-26 Peel Road,
Douglas, Isle Man, United Kingdom

(111) No. 61887

(180) 07/12/2033

(540) Registration



(511) 05, 29, 30 and 32

(210) No. 49442

(220) 08/12/2023

(732) SUNTORY BEVERAGE & FOOD ASIA
PTE. LTD.
400 Orchard Road, #11-12, Orchard Towers,
Singapore 238875

(111) No. 61888

(180) 08/12/2033

(540) Registration

House of Authenticity

(511) 29, 30 and 31

(210) No. 49443

(220) 08/12/2023

(732) DSR Fruits Sdn Bhd

No. 32-1, Jalan Eco Santuari 8/2A, Eco
Santuari, 42500 Telok Panglima Garang,
Selangor, Malaysia

(111) No. 61889

(180) 08/12/2033

(540) Registration

OMSA

(511) 09, 35 and 42

(210) No. 49444

(220) 08/12/2023

(732) DSR Fruits Sdn Bhd

No. 32-1, Jalan Eco Santuari 8/2A, Eco
Santuari, 42500 Telok Panglima Garang,
Selangor, Malaysia

(111) No. 61890

(180) 08/12/2033

(540) Registration

Miovapor

(511) 34

(210) No. 49445

(220) 08/12/2023

(732) SHENZHEN CIGREAT TECHNOLOGY CO.,
LTD.

2/F, 3/F & 5/F, Building C and 2/F, 3/F, 4/F &

6/F, Building K, Licheng Technology

Industrial Park, Xinhe Avenue, Gonghe

Community, Shajing Subdistrict, Bao'an

District, Shenzhen City, Guangdong Province,

China

(111) No. 61891

(180) 08/12/2033

(540) Registration



(511) 19 and 35

(210) No. 49446

(220) 11/12/2023

(732) Siam City Cement Public Company Limited
199 Column Tower, Ratchadapisek Road,
Klongtoey, Bangkok 10110, Thailand

(111) No. 61892

(180) 11/12/2033

(540) Registration

CONWOOD

(511) 19 and 35

(210) No. 49447

(220) 11/12/2023

(732) Siam City Cement Public Company Limited
199 Column Tower, Ratchadapisek Road,
Klongtoey, Bangkok 10110, Thailand

(111) No. 61893

(180) 11/12/2033

(540) Registration



(511) 35, 37 and 40

(210) No. 49448

(220) 11/12/2023

(732) Siam City Cement Public Company Limited
199 Column Tower, Ratchadapisek Road,
Klongtoey, Bangkok 10110, Thailand

(111) No. 61894

(180) 11/12/2033

(540) Registration

POLHAM

(511) 18

(210) No. 49450

(220) 11/12/2023

(732) A.TION FASHION, INC.

426-17, Dunchon-dong, Kangdong-gu, Seoul,
Republic Of Korea

(111) No. 61895

(180) 11/12/2033

(540) Registration

POLHAM

(511) 25

(210) No. 49451

(220) 11/12/2023

(732) A.TION FASHION, INC.

426-17, Dunchon-dong, Kangdong-gu, Seoul,
Republic Of Korea

(111) No. 61896

(180) 11/12/2033

(540) Registration

POLHAM

(511) 35

(210) No. 49452

(220) 11/12/2023

(732) A.TION FASHION, INC.

426-17, Dunchon-dong, Kangdong-gu, Seoul,
Republic Of Korea

(111) No. 61897

(180) 11/12/2033

(540) Registration

 **PROJECT M**

(511) 18

(210) No. 49453

(220) 11/12/2023

(732) A.TION FASHION, INC.

426-17, Dunchon-dong, Kangdong-gu, Seoul,
Republic Of Korea

(111) No. 61898

(180) 11/12/2033

(540) Registration



(511) 25

(210) No. 49454

(220) 11/12/2023

(732) A.TION FASHION, INC.

426-17, Dunchon-dong, Kangdong-gu, Seoul,
Republic Of Korea

(111) No. 61899

(180) 11/12/2033

(540) Registration



(511) 35

(210) No. 49455

(220) 11/12/2023

(732) A.TION FASHION, INC.

426-17, Dunchon-dong, Kangdong-gu, Seoul,
Republic Of Korea

(111) No. 61900

(180) 11/12/2033

(540) Registration

JMC Jimico

(511) 16

(210) No. 49456

(220) 11/12/2023

(732) OUYANG HUI

NO.102, KAIYUAN NORTH ROAD,

NIANSANLI, YIWU, ZHEJIANG, CHINA

(111) No. 61901

(180) 11/12/2033

(540) Registration



(511) 34

(210) No. 49463

(220) 12/12/2023

(732) Carreras Limited

Globe House, 4 Temple Place, London

WC2R 2PG, United Kingdom,

United Kingdom

(111) No. 61902

(180) 12/12/2033

(540) Registration

AOC

(511) 09

(210) No. 49464

(220) 12/12/2023

(732) Li Kenong

No. 196, Village Group 19, Yangshu Village,
Dongjiao Township, Xiangxiang City, Hunan
Province, China

(111) No. 61903

(180) 12/12/2033

(540) Registration

 **Safewell**

(511) 06, 09 and 35

(210) No. 49465

(220) 12/12/2023

(732) NINGBO SAFEWELL SMART SECURITY
PRODUCTS CO., LTD

(6-1)-(6-5) ROOM#647, #1858 SHUGUANG
NORTH ROAD, YIN ZHOU DISTRICT,
NINGBO, CHINA

(111) No. 61904

(180) 12/12/2033

(540) Registration

TOOPRE

(511) 12

(210) No. 49466

(220) 12/12/2023

(732) Kunshan Toopre Outdoor Supplies Co.,LTD
Room 2,No.99, Qipu Weat Road, Zhangpu
Town, Kunshan, China

(111) No. 61905

(180) 12/12/2033

(540) Registration

冠捷

(511) 09

(210) No. 49467

(220) 12/12/2023

(732) Li Kenong
No. 196, Village Group 19, Yangshu Village,
Dongjiao Township, Xiangxiang City, Hunan
Province, China

(111) No. 61906

(180) 12/12/2033

(540) Registration



**THE SPORTS
WAREHOUSE**

(511) 35

(210) No. 49468

(220) 13/12/2023

(732) PT Map Aktif Adiperkasa Tbk

Sahid Sudirman Center 26th Floor, Jl. Jend.

Sudirman Kav. 86, Jakarta Pusat 10220,

Indonesia

(111) No. 61907

(180) 13/12/2033

(540) Registration



7-ELEVEN
INTERNATIONAL

(511) 35 and 36

(210) No. 49473

(220) 14/12/2023

(732) 7-Eleven International LLC

3200 Hackberry Road, Irving, Texas 75063

USA, United States Of America

(111) No. 61908

(180) 14/12/2033

(540) Registration

BYOTOUTY

(511) 03

(210) No. 49474

(220) 14/12/2023

(732) GUANGZHOU BIYING COSMETICS CO.,
LTD

No. 68, Liangtian Country, Zhongluotan
Town, Baiyun District, Guangzhou City,
China

(111) No. 61909

(180) 14/12/2033

(540) Registration

AOPEIBOTO

(511) 03

(210) No. 49475

(220) 14/12/2023

(732) GUANGZHOU BIYING COSMETICS CO.,
LTD

No. 68, Liangtian Country, Zhongluotan
Town, Baiyun District, Guangzhou City,
China

(111) No. 61910

(180) 14/12/2033

(540) Registration

BIYING

(511) 03

(210) No. 49476

(220) 14/12/2023

(732) GUANGZHOU BIYING COSMETICS CO.,
LTD

No. 68, Liangtian Country, Zhongluotan Town,
Baiyun District, Guangzhou City, China

(111) No. 61911

(180) 14/12/2033

(540) Registration



(511) 32

(210) No. 49477

(220) 14/12/2023

(732) BOON RAWD BREWERY CO., LTD.

No. 999, Samsen Road, Thanon
Nakornchaisri Sub-district, Dusit District,
Bangkok 10300, Thailand

(111) No. 61912

(180) 14/12/2033

(540) Registration



(511) 32

(210) No. 49478

(220) 14/12/2023

(732) BOON RAWD BREWERY CO., LTD.

No. 999, Samsen Road, Thanon

Nakornchaisri Sub-district, Dusit District,

Bangkok 10300, Thailand

(111) No. 61913

(180) 14/12/2033

(540) Registration

TRADEMARK COLLECTION

(511) 43

(210) No. 49479

(220) 14/12/2023

(732) TMH Worldwide, LLC

22 Sylvan Way, Parsippany, New Jersey

07054, United States Of America

(111) No. 61914

(180) 14/12/2033

(540) Registration



(511) 43

(210) No. 49480

(220) 14/12/2023

(732) TMH Worldwide, LLC and Wyndham Hotels and Resorts, LLC

22 Sylvan Way, Parsippany, New Jersey

07054, United States Of America and 22

Sylvan Way, Parsippany, New Jersey 07054,

United States Of America

(111) No. 61915

(180) 14/12/2033

(540) Registration



(511) 32

(210) No. 49481

(220) 15/12/2023

(732) QIANG LI

UNIT 404, BLDG 10, SHANGCHENG

YAYUAN, NO. 68, BAIYUN RD,

CANGYUN DIST, FUZHOU, FUJIAN

PROV, CHINA

(111) No. 61916

(180) 15/12/2033

(540) Registration



(511) 41

(210) No. 49482

(220) 15/12/2023

(732) Q-TALENT MEDIA COMPANY LIMITED

No. 506/15/3 Ba Thang Hai Street, Ward 14,
District 10, Ho Chi Minh City, Vietnam

(111) No. 61917

(180) 15/12/2033

(540) Registration



(511) 30

(210) No. 49483

(220) 15/12/2023

(732) Guangzhou Qiaomai Network Technology

Consulting Co., Ltd.

Room A3-4, 2nd and 3rd floor, Building A,
No. 5, Suiyan Road, Kuipeng, Liwan District,
Guangzhou City, Guangdong Province, China

(111) No. 61918

(180) 15/12/2033

(540) Registration

The logo consists of the letters 'ABD' in a bold, italicized, serif font.

(511) 30

(210) No. 49484

(220) 15/12/2023

(732) Chen Yaoqin

No. 4, Lane 1, Xincuohe, Shangweikou,
Debei Village, Linpan Town, Lancheng,
Jiedong District, Jieyang City, Guangdong
Province, China

(111) No. 61919

(180) 15/12/2033

(540) Registration

The logo consists of the word 'TARGET' in a bold, sans-serif font.

(511) 09

(210) No. 49485

(220) 15/12/2023

(732) Target Brands, Inc.

1000 Nicollet Mall, Minneapolis, Minnesota
55403-2467, United States Of America

(111) No. 61920

(180) 15/12/2033

(540) Registration

TARGET

(511) 35

(210) No. 49486

(220) 15/12/2023

(732) Target Brands, Inc.

1000 Nicollet Mall, Minneapolis, Minnesota

55403-2467, United States Of America

(111) No. 61921

(180) 15/12/2033

(540) Registration

TARGET

(511) 36

(210) No. 49487

(220) 15/12/2023

(732) Target Brands, Inc.

1000 Nicollet Mall, Minneapolis, Minnesota

55403-2467, United States Of America

(111) No. 61922

(180) 15/12/2033

(540) Registration



(511) 09

(210) No. 49488

(220) 15/12/2023

(732) Target Brands, Inc.

1000 Nicollet Mall, Minneapolis, Minnesota

55403-2467, United States Of America

(111) No. 61923

(180) 15/12/2033

(540) Registration

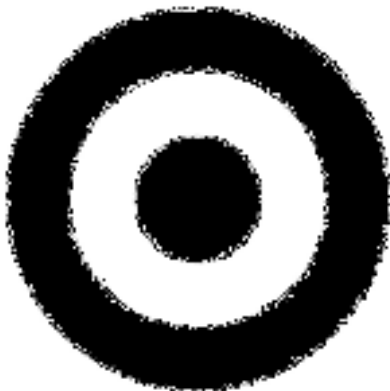

(511) 36

(210) No. 49489

(220) 15/12/2023

(732) Target Brands, Inc.

1000 Nicollet Mall, Minneapolis, Minnesota

55403-2467, United States Of America

(111) No. 61924

(180) 15/12/2033

(540) Registration



(511) 09

(210) No. 49490

(220) 15/12/2023

(732) Target Brands, Inc.

1000 Nicollet Mall, Minneapolis, Minnesota

55403-2467, United States Of America

(111) No. 61925

(180) 15/12/2033

(540) Registration



(511) 35

(210) No. 49491

(220) 15/12/2023

(732) Target Brands, Inc.

1000 Nicollet Mall, Minneapolis, Minnesota

55403-2467, United States Of America

(111) No. 61926

(180) 15/12/2033

(540) Registration



(511) 36

(210) No. 49492

(220) 15/12/2023

(732) Target Brands, Inc.

1000 Nicollet Mall, Minneapolis, Minnesota

55403-2467, United States Of America

(111) No. 61927

(180) 15/12/2033

(540) Registration



(511) 35

(210) No. 49493

(220) 15/12/2023

(732) Target Brands, Inc.

1000 Nicollet Mall, Minneapolis, Minnesota

55403-2467, United States Of America

(111) No. 61928

(180) 15/12/2033

(540) Registration



(511) 03, 05 and 32

(210) No. 49497

(220) 19/12/2023

(732) T.C. Union Global Public Company Limited
9/446-447 Moo 3, Rama II Road,
Bangkrachao, Muang Samutsakorn, 74000,
Samutsakorn, Thailand

(111) No. 61929

(180) 19/12/2033

(540) Registration

DCD

(511) 35, 36 and 45

(210) No. 49498

(220) 19/12/2023

(732) DCD & Partners Co., Ltd
3rd Floor Royal Square Building,
Samsenthay Road, Noongduangnuea Village,
Sikhottaboong District, Vientiane Cap,
Lao People's Democratic Republic

(111) No. 61930

(180) 19/12/2033

(540) Registration



danxuenilan
丹雪尼

(511) 03 and 35

(210) No. 49499

(220) 19/12/2023

(732) TA VAN SON

Chua Village, Dong Son Commune, Bac
Giang City, Bac Giang Province, Vietnam

(111) No. 61931

(180) 19/12/2033

(540) Registration



Mamy Poko
pants
HAPPY
All Day Dry

(511) 05

(210) No. 49500

(220) 19/12/2023

(732) UNI-CHARM CORPORATION

182 Shimobun, Kinsei-cho, Shikokuchuo-shi,
Ehime-ken, Japan

(111) No. 61932

(180) 19/12/2033

(540) Registration



(511) 09 and 25

(210) No. 49504

(220) 20/12/2023

(732) Dongguan Liuhe Aluminum Products Co.,
Ltd

Room 101, 1 F, No. 3 Yinxing Road,
Xiegang, Xiegang Town, Dongguan City,
Guangdong Province 523000, China

(111) No. 61933

(180) 20/12/2033

(540) Registration

WYNDHAM GARDEN

(511) 43

(210) No. 49507

(220) 21/12/2023

(732) Wyndham Hotels and Resorts, LLC
22 Sylvan Way, Parsippany,
New Jersey 07054 USA

(111) No. 61934

(180) 21/12/2033

(540) Registration

The logo for 'KEEPPLAY' features a stylized 'K' icon to the left of the word 'KEEPPLAY' in a bold, sans-serif font.

(511) 28

(210) No. 49508

(220) 21/12/2023

(732) Guangdong Qman Toys Industry Co., Ltd.

Intersection of Xingye West 2nd Road and
Xingye South Road, Laimei Industrial Park,
Chenghai District, Shantou, Guangdong,
China

(111) No. 61935

(180) 21/12/2033

(540) Registration



(511) 35, 39 and 43

(210) No. 49509

(220) 22/12/2023

(732) Mr. Jullapun Vongkittirux

9/29 Phahonyothin Road, Chatuchak
Subdistrict, Chatuchak District, Bangkok
10400, Thailand

(111) No. 61936

(180) 22/12/2033

(540) Registration



(511) 06

(210) No. 49510

(220) 22/12/2023

(732) MR. T-TUTT JUNGKANKUL

222 Rama three road, Bangkorlaem, 10120,
Bangkok, Thailand

(111) No. 61937

(180) 22/12/2033

(540) Registration



(511) 03

(210) No. 49511

(220) 22/12/2023

(732) MR. T-TUTT JUNGKANKUL

222 Rama three road , Bangkorlaem, 10120,
Bangkok, Thailand

(111) No. 61938

(180) 22/12/2033

(540) Registration

**SAMCO
FREEZERWEAR**

(511) 35

(210) No. 49512

(220) 22/12/2023

(732) REFRIGIWEAR, LLC

54 Breakstone Drive, Dahlonga,

Georgia 30533, United States Of America

(111) No. 61939

(180) 22/12/2033

(540) Registration

**SAMCO
FREEZERWEAR**

(511) 25

(210) No. 49513

(220) 22/12/2023

(732) REFRIGIWEAR, LLC

54 Breakstone Drive, Dahlonga,

Georgia 30533, United States Of America

(111) No. 61940

(180) 22/12/2033

(540) Registration

Draliapro

(511) 03

(210) No. 49514

(220) 22/12/2023

(732) Yimei pharmaceutical makeup (Guangdong)

Biotechnology Co., Ltd

Room 109, Building M3b, No.1 Hualian 1st

Road, Lianbian Pengxi, Helong Street,

Baiyun District, Guangzhou City, 510080,

China

(111) No. 61941

(180) 22/12/2033

(540) Registration

MEG-3

(511) 05

(210) No. 49515

(220) 24/12/2023

(732) DSM IP Assets B.V.

Het Overloon 1, 6411 TE Heerlen,

The Netherlands

(111) No. 61942

(180) 24/12/2033

(540) Registration

The logo for YUSEN, featuring the word "YUSEN" in a bold, black, sans-serif font with a textured, slightly distressed appearance.

(511) 35

(210) No. 49517

(220) 25/12/2023

(732) YONGKANG PUYUAN TOOLS CO., LTD.

Room 101, West Side, First Floor, Building
1, No. 168, Qiancheng Road, Nizhai Natural
Village, Nizhai Village, Huajie Town,
Yongkang City, Jinhua City, Zhejiang
Province, China

(111) No. 61943

(180) 25/12/2033

(540) Registration

The logo for NUCTECH, featuring a stylized circular icon to the left of the word "NUCTECH" in a bold, black, sans-serif font.

(511) 09

(210) No. 49518

(220) 25/12/2023

(732) NUCTECH COMPANY LIMITED

2ND FLOOR, BLOCK A, TONGFANG
BUILDING, SHUANGQINGLU, HAIDIAN
DISTRICT, BEIJING, CHINA

(111) No. 61944

(180) 25/12/2033

(540) Registration



(511) 05

(210) No. 49521

(220) 26/12/2023

(732) DSM IP Assets B.V.

Het Overloon 1, 6411 TE Heerlen,

The Netherlands

(111) No. 61945

(180) 26/12/2033

(540) Registration



(511) 35

(210) No. 49522

(220) 27/12/2023

(732) Guangzhou Meitianhui Technology Co., Ltd.

Room 3307, Building 3, No. 2 Chebei

Dagang Road, Tianhe District, Guangzhou,

China

(111) No. 61946

(180) 27/12/2033

(540) Registration

BreezeIN

(511) 11

(210) No. 49531

(220) 28/12/2023

(732) Shenzhen TCL New Technology Co., LTD.

9/F, Building D4, International E City, 1001

Zhongshan Park Road, Xili Street, Nanshan

District, Shenzhen, 518000 Guangdong, China

(111) No. 61947

(180) 28/12/2033

(540) Registration



(511) 03

(210) No. 49532

(220) 28/12/2023

(732) EQUATOR PURE NATURE CO., LTD.

No. 9/245 UM Tower, 24th Floor,

Ramkhamhaeng Road, Suanluang,

Suanluang, Bangkok 10250, Thailand

(111) No. 61948

(180) 28/12/2033

(540) Registration

KMA

(511) 03

(210) No. 49533

(220) 28/12/2023

(732) O.C.C. Public Company Limited

729/4-7 Radchadaphisek Rd., Bangpongpan,
Yannawa, 10120, Bangkok, Thailand

(111) No. 61949

(180) 28/12/2033

(540) Registration

力狼
LILANG

(511) 31

(210) No. 49534

(220) 28/12/2023

(732) Huaxing pet Food Co., Ltd

No.3, Pet Food Industrial Park, Nanhe
District, Xingtai City, Hebei Province, China

(111) No. 61950

(180) 28/12/2033

(540) Registration

國泰

(511) 36

(210) No. 49535

(220) 29/12/2023

(732) CATHAY FINANCIAL HOLDING CO.,
LTD.

No. 296, Ren Ai Rd., Sec. 4 Taipei, Taiwan

(111) No. 61951

(180) 29/12/2033

(540) Registration

国泰

(511) 36

(210) No. 49536

(220) 29/12/2023

(732) CATHAY FINANCIAL HOLDING CO.,
LTD.

No. 296, Ren Ai Rd., Sec. 4 Taipei, Taiwan

(111) No. 61952

(180) 29/12/2033

(540) Registration

Cathay

(511) 36

(210) No. 49537

(220) 29/12/2023

(732) CATHAY FINANCIAL HOLDING CO.,
LTD.

No. 296, Ren Ai Rd., Sec. 4 Taipei, Taiwan

(111) No. 61953

(180) 29/12/2033

(540) Registration



(511) 09

(210) No. 49538

(220) 29/12/2023

(732) CATHAY FINANCIAL HOLDING CO.,
LTD.

No. 296, Ren Ai Rd., Sec. 4 Taipei, Taiwan

(111) No. 61954

(180) 29/12/2033

(540) Registration



(511) 35

(210) No. 49539

(220) 29/12/2023

(732) CATHAY FINANCIAL HOLDING CO.,
LTD.

No. 296, Ren Ai Rd., Sec. 4 Taipei, Taiwan

(111) No. 61955

(180) 29/12/2033

(540) Registration



(511) 36

(210) No. 49540

(220) 29/12/2023

(732) CATHAY FINANCIAL HOLDING CO.,
LTD.

No. 296, Ren Ai Rd., Sec. 4 Taipei, Taiwan

(111) No. 61956

(180) 29/12/2033

(540) Registration



(511) 38

(210) No. 49541

(220) 29/12/2023

(732) CATHAY FINANCIAL HOLDING CO.,
LTD.

No. 296, Ren Ai Rd., Sec. 4 Taipei, Taiwan

(111) No. 61957

(180) 29/12/2033

(540) Registration



(511) 42

(210) No. 49542

(220) 29/12/2023

(732) CATHAY FINANCIAL HOLDING CO.,
LTD.

No. 296, Ren Ai Rd., Sec. 4 Taipei, Taiwan

(111) No. 61958

(180) 29/12/2033

(540) Registration

CAMCLAR

(511) 34

(210) No. 49544

(220) 29/12/2023

(732) CAMCLAR SCIENCE AND TECHNOLOGY
LIMITED

UNIT 616 /6F KAM TEEM INDUSTRIAL
BUILDING 135 CONNAUGHT RD WEST,
SAI WAN, 999077, HONG KONG

(111) No. 61959

(180) 29/12/2033

(540) Registration



(511) 44

(210) No. 49415

(220) 05/12/2023

(732) ບໍລິສັດ ສຸນຄວາມງາມ ເອເຟລັສ ບິວຕີ ເຊັນເຕີ
ຈໍາກັດຜູ້ດຽວ
ບ້ານ ທາດຫຼວງກາງ, ເມືອງ ໄຊເສດຖາ,
ນະຄອນຫຼວງວຽງຈັນ, ສປປ ລາວ

(111) No. 61960

(180) 05/12/2033

(540) Registration



(511) 03

(210) No. 49418

(220) 06/12/2023

(732) ນາງ ດາວວອນ ຝິມວິຈິດ

ບ້ານ ຫົວນາ, ເມືອງນ້ຳບາກ, ແຂວງ ຫຼວງພະບາງ,

ສປປ ລາວ

(111) No. 61961

(180) 06/12/2033

(540) Registration



(511) 05 and 35

(210) No. 49419

(220) 06/12/2023

(732) ບໍລິສັດ ເຮຊັນຟາມາຊຸທິໂກ (ລາວ) ຈຳກັດ

ບ້ານ ໜອງບົວທອງໃຕ້, ເມືອງ ສີໂຄດຕະບອງ,

ນະຄອນຫຼວງວຽງຈັນ, ສປປ ລາວ

(111) No. 61962

(180) 06/12/2033

(540) Registration



(511) 30

(210) No. 49420

(220) 06/12/2023

(732) ບໍລິສັດ ຮຸ່ງໂຊກ ຈຳກັດຜູ້ດຽວ

ບ້ານ ມິໄຊ, ເມືອງ ຈັນທະບູລີ, ນະຄອນຫຼວງວຽງຈັນ,

ສປປ ລາວ

(111) No. 61963

(180) 06/12/2033

(540) Registration



(511) 30

(210) No. 49431

(220) 07/12/2023

(732) ນາງ ຂັນທະລີ ເດດວິງຜັນ

ບ້ານ ໂນນສະຫວ່າງ, ເມືອງ ວຽງຄຳ, ແຂວງ ວຽງຈັນ,

ສປປ ລາວ

(111) No. 61964

(180) 07/12/2033

(540) Registration



(511) 30

(210) No. 49432

(220) 07/12/2023

(732) ນາງ ຂັນທະລີ ເດດວິງພັນ

ບ້ານ ໂນນສະຫວ່າງ, ເມືອງ ວຽງຄໍາ, ແຂວງ ວຽງຈັນ,
ສປປ ລາວ

(111) No. 61965

(180) 07/12/2033

(540) Registration



(511) 35

(210) No. 49440

(220) 08/12/2023

(732) ບໍລິສັດ ອໍ້ຫຼຽນການຄ້າ ຂາເຂົ້າຂາອອກ ຈຳກັດຜູ້ດຽວ

ບ້ານ ຂົວຫຼວງເໜືອ, ເມືອງຈັນທະບູລີ,
ນະຄອນຫຼວງວຽງຈັນ, ສປປ ລາວ

(111) No. 61966

(180) 08/12/2033

(540) Registration



(511) 35

(210) No. 49441

(220) 08/12/2023

(732) ບໍລິສັດ ອີ້ຫຼຽນການຄ້າ ຂາເຂົ້າຂາອອກ ຈຳກັດຜູ້ດຽວ
ບ້ານ ຂົວຫຼວງເໜືອ, ເມືອງຈັນທະບູລີ,
ນະຄອນຫຼວງວຽງຈັນ, ສປປ ລາວ

(111) No. 61967

(180) 08/12/2033

(540) Registration



(511) 39

(210) No. 49457

(220) 12/12/2023

(732) ບໍລິສັດ ສະໜາມບິນສາກົນບໍ່ແກ້ວ ຈຳກັດ.
ຕຶກບັນເທີງ, ຖະໜົນດອກງົວຄຳ,
ເຂດເສດຖະກິດພິເສດ, ເມືອງຕົ້ນເຜິ້ງ, ແຂວງບໍ່ແກ້ວ,
ສປປ ລາວ

(111) No. 61968

(180) 12/12/2033

(540) Registration



(511) 30 and 43

(210) No. 49458

(220) 12/12/2023

(732) ຫ້າວ ຄຳຜູ້ມິນ ແກ້ວໄຊມິ

ບ້ານ ຊ້າງຄູ້, ເມືອງ ໄຊທານີ, ນະຄອນຫຼວງວຽງຈັນ,
ສປປ ລາວ

(111) No. 61969

(180) 12/12/2033

(540) Registration



(511) 09

(210) No. 49460

(220) 12/12/2023

(732) ບໍລິສັດ ຈິງດ້າ ການຄ້າ ຂາເຂົ້າ-ຂາອອກ ຈຳກັດຜູ້ດຽວ

ບ້ານ ໜອງພະຍາ, ເມືອງ ໄຊທານີ,
ນະຄອນຫຼວງວຽງຈັນ, ສປປ ລາວ

(111) No. 61970

(180) 12/12/2033

(540) Registration



(511) 31

(210) No. 49461

(220) 12/12/2023

(732) ສວນໝາກນາວ ອຳໄພ ສວນບຸກຄົນ

ບ້ານ ດອນໂມ, ເມືອງ ຊຽງເງິນ, ແຂວງ ຫຼວງພະບາງ,

ສປປ ລາວ

(111) No. 61971

(180) 12/12/2033

(540) Registration



(511) 36

(210) No. 49462

(220) 12/12/2023

(732) ທະນາຄານ ສິ່ງເສີມກະສິກຳ ຈຳກັດ

ບ້ານພະຂາວ, ເມືອງໄຊທານີ, ນະຄອນຫຼວງວຽງຈັນ,

ສປປ ລາວ

(111) No. 61972

(180) 12/12/2033

(540) Registration



(511) 09 and 35

(210) No. 49469

(220) 13/12/2023

(732) ບໍລິສັດ ຫົວຊີງ ອຸປະກອນເສີມດິຈິຕອນເອເລັກໂຕຣນິກ

ຈຳກັດຜູ້ດຽວ

ບ້ານ ດົງປາລານທ່າ, ເມືອງ ຫາດຊາຍຝອງ,

ນະຄອນຫຼວງວຽງຈັນ, ສປປ ລາວ

(111) No. 61973

(180) 13/12/2033

(540) Registration



(511) 09 and 35

(210) No. 49470

(220) 13/12/2023

(732) ບໍລິສັດ ຫົວຊີງ ອຸປະກອນເສີມດິຈິຕອນເອເລັກໂຕຣນິກ

ຈຳກັດຜູ້ດຽວ

ບ້ານ ດົງປາລານທ່າ, ເມືອງ ສີສັດຕະນາກ,

ນະຄອນຫຼວງວຽງຈັນ, ສປປ ລາວ

(111) No. 61974

(180) 13/12/2033

(540) Registration



(511) 09 and 35

(210) No. 49471

(220) 13/12/2023

(732) ບໍລິສັດ ຫົວຊີງ ອຸປະກອນເສີມດິຈິຕອນເອເລັກໂຕຣນິກ

ຈໍາກັດຜູ້ດຽວ

ບ້ານ ດົງປ່າລານທ່າ, ເມືອງ ສີສັດຕະນາກ,

ນະຄອນຫຼວງວຽງຈັນ, ສປປ ລາວ

(111) No. 61975

(180) 13/12/2033

(540) Registration



(511) 30

(210) No. 49494

(220) 18/12/2023

(732) ບໍລິສັດ ບໍລິຄໍາໄຊການຄ້າຂາອອກ-ຂາເຂົ້າ

ຈໍາກັດຜູ້ດຽວ.

ບ້ານ ອານຸສອນ, ເມືອງ ປາກຊັນ, ແຂວງ ບໍລິຄໍາໄຊ,

ສປປ ລາວ

(111) No. 61976

(180) 18/12/2033

(540) Registration



(511) 30 and 44

(210) No. 49495

(220) 18/12/2023

(732) ບໍລິສັດ ໂພຄະຊັບພັດທະນາກະສິກໍາ ຂາເຂົ້າ-ຂາອອກ
ຈໍາກັດຜູ້ດຽວ.

ບ້ານ ວັງໄຮ, ເມືອງ ໄຊ, ແຂວງ ອຸດົມໄຊ, ສປປ ລາວ

(111) No. 61977

(180) 18/12/2033

(540) Registration



(511) 29

(210) No. 49496

(220) 18/12/2023

(732) ວິສາຫະກິດ ສ່ວນບຸກຄົນ ໄຄແຜ່ນອົບກອບຫຼວງພະບາງ
ເອັນ-ວີ

ບ້ານ ນາວຽງຄໍາ, ນະຄອນຫຼວງພະບາງ,

ແຂວງ ຫຼວງພະບາງ, ສປປ ລາວ

(111) No. 61978

(180) 18/12/2033

(540) Registration



(511) 32

(210) No. 49505

(220) 20/12/2023

(732) ບໍລິສັດ ລາວ ຈີນ ມິດລິງ ໂຄລ ມາຍນິງ ອິນຈີເນຍລິງ

ຄອນສະຕັກຊັນ

ບ້ານ ດອນແດງ, ເມືອງ ຈັນທະບູລີ,

ນະຄອນຫຼວງວຽງຈັນ, ສປປ ລາວ

(111) No. 61979

(180) 20/12/2033

(540) Registration



(511) 37

(210) No. 49506

(220) 20/12/2023

(732) ບໍລິສັດ ວັດທະນາ ກໍ່ສ້າງ ຂົວ-ທາງ ແລະ ຊົນລະປະທານ

ຈໍາກັດຜູ້ດຽວ

ບ້ານ ໄຊມຸງຄຸນ, ເມືອງ ນາຊາຍທອງ,

ນະຄອນຫຼວງວຽງຈັນ, ສປປ ລາວ

(111) No. 61980

(180) 20/12/2033

(540) Registration



(511) 20 and 35

(210) No. 49516

(220) 25/12/2023

(732) MR KAI SUN

ບ້ານ ວັດໄຕນ້ອຍທົ່ງ, ເມືອງ ສີໂຄດຕະບອງ,

ນະຄອນຫຼວງວຽງຈັນ, ສປປ ລາວ

(111) No. 61981

(180) 25/12/2033

(540) Registration



(511) 39

(210) No. 49520

(220) 26/12/2023

(732) ບໍລິສັດ ເດີຊັນ ທຣາໂວ ຈຳກັດຜູ້ດຽວ

ຖະໜົນ 13 ໃຕ້, ບ້ານ ໂພຄຳ, ເມືອງໄຊທານີ,

ນະຄອນຫຼວງວຽງຈັນ, ສປປ ລາວ

(111) No. 61982

(180) 26/12/2033

(540) Registration

**Four Thousand
Islands**

(511) 01, 02, 03, 04, 05, 06, 07, 08, 09, 10, 11, 12,
13, 14, 15, 16, 17, 18, 19, 20, 21, 22, 23, 24, 25, 26,
27, 28, 29, 30, 31, 32, 33, 34, 35, 36, 37, 38, 39, 40,
41, 42, 43, 44 and 45

(210) No. 49524

(220) 27/12/2023

(732) ບໍລິສັດ ຮ່ວມພັດທະນາ ສີທັນດອນ ຈຳກັດ

ບ້ານ ທ່າຄໍ້, ເມືອງໂຂງ, ແຂວງ ຈຳປາສັກ, ສປປ ລາວ

(111) No. 61984

(180) 27/12/2033

(540) Registration

四千美島

(511) 01, 02, 03, 04, 05, 06, 07, 08, 09, 10, 11, 12,
13, 14, 15, 16, 17, 18, 19, 20, 21, 22, 23, 24, 25, 26,
27, 28, 29, 30, 31, 32, 33, 34, 35, 36, 37, 38, 39, 40,
42, 43, 44 and 45

(210) No. 49525

(220) 27/12/2023

(732) ບໍລິສັດ ຮ່ວມພັດທະນາ ສີທັນດອນ ຈຳກັດ

ບ້ານ ທ່າຄໍ້, ເມືອງໂຂງ, ແຂວງ ຈຳປາສັກ, ສປປ ລາວ

(111) No. 61985

(180) 27/12/2033

(540) Registration

ເຈີນລົງ

(511) 03, 05, 20, 29, 30, 31, 34, 35 and 43

(210) No. 49526

(220) 27/12/2023

(732) ກຸ່ມບໍລິສັດ 520 ຈຳກັດ

ບ້ານ ທ່າຄໍ້, ເມືອງໂຂງ, ແຊວງຈຳປາສັກ, ສປປ ລາວ

(111) No. 61986

(180) 27/12/2033

(540) Registration

真腊

(511) 03, 05, 20, 29, 30, 31, 34, 35 and 43

(210) No. 49527

(220) 27/12/2023

(732) ກຸ່ມບໍລິສັດ 520 ຈຳກັດ

ບ້ານ ທ່າຄໍ້, ເມືອງໂຂງ, ແຊວງຈຳປາສັກ, ສປປ ລາວ

(111) No. 61987

(180) 27/12/2033

(540) Registration

CHENLA

(511) 03, 05, 20, 29, 30, 31, 34, 35 and 43

(210) No. 49528

(220) 27/12/2023

(732) ກຸ່ມບໍລິສັດ 520 ຈຳກັດ

ບ້ານ ທ່າຄໍ້, ເມືອງໂຂງ, ແຂວງຈຳປາສັກ, ສປປ ລາວ

(111) No. 61988

(180) 27/12/2033

(540) Registration

SVLF

(511) 45

(210) No. 49529

(220) 27/12/2023

(732) ບໍລິສັດ ເອສວິລິເມີມ ຈຳກັດຜູ້ດຽວ

ຖະໜົນ ທາງຮ່ອມ 6, ບ້ານ ໄຊສະຫວ່າງ,

ເມືອງ ໄຊທານີ, ນະຄອນຫຼວງວຽງຈັນ, ສປປ ລາວ

(111) No. 61989

(180) 27/12/2033

(540) Registration



(511) 02

(210) No. 49530

(220) 28/12/2023

(732) ນາງ ສິມສະໝອນ ສຸລິສັກ

ໜ່ວຍ 13, ບ້ານໂຄກສະອາດ, ເມືອງໄຊທານີ,

ນະຄອນຫຼວງວຽງຈັນ, ສປປ ລາວ

(111) No. 61990

(180) 28/12/2033

(540) Registration



(511) 01

(210) No. 49545

(220) 02/01/2024

(732) JORAKAY CORPORATION CO., LTD.

10 Krungthepkreetha Road, Thapchang,

Saphansung, Bangkok 10250, Thailand

(111) No. 61991

(180) 02/01/2034

(540) Registration



(511) 02

(210) No. 49546

(220) 02/01/2024

(732) JORAKAY CORPORATION CO., LTD.

10 Krungthepkreetha Road, Thapchang,

Saphansung, Bangkok 10250, Thailand

(111) No. 61992

(180) 02/01/2034

(540) Registration



(511) 19

(210) No. 49547

(220) 02/01/2024

(732) JORAKAY CORPORATION CO., LTD.

10 Krungthepkreetha Road, Thapchang,

Saphansung, Bangkok 10250, Thailand

(111) No. 61993

(180) 02/01/2034

(540) Registration



(511) 34

(210) No. 49557

(220) 08/01/2024

(732) GOLDEN LEAF (MACAU) TOBACCO'S
MANUFACTURING LIMITED
RUA DOS PESCADORES, N°66, EDIFICIO
INDUSTRIAL OCEANO, BLOCO II,
3°ANDAR-A, EM MACAU, CHINA

(111) No. 61994

(180) 08/01/2034

(540) Registration

WD-MIMO⁺

(511) 09, 38 and 42

(210) No. 49559

(220) 08/01/2024

(732) Beijing Wide Technology Co., Ltd.
(Yizhuang Group, High-end Industrial Zone
of Beijing Pilot Free Trade Zone) 101, Floor
1-5, Building 4, Zone 3, No.88, Jinghai Fifth
Road, Beijing Economic and Technological
Development Zone, Beijing, China

(111) No. 61995

(180) 08/01/2034

(540) Registration



(511) 30

(210) No. 49560

(220) 08/01/2024

(732) THAI WAH PUBLIC COMPANY LIMITED

21/11, 21/13 Thai Wah Tower 1, Floor 6,
Sathorn Road, Thungmahamek, Sathorn,
Bangkok 10120, Thailand

(111) No. 61996

(180) 08/01/2034

(540) Registration

Widecreate

(511) 09, 38 and 42

(210) No. 49561

(220) 08/01/2024

(732) Beijing Wide Technology Co., Ltd.

(Yizhuang Group, High-end Industrial Zone
of Beijing Pilot Free Trade Zone) 101, Floor
1-5, Building 4, Zone 3, No.88, Jinghai Fifth
Road, Beijing Economic and Technological
Development Zone, Beijing, China

(111) No. 61997

(180) 08/01/2034

(540) Registration



(511) 09, 38 and 42

(210) No. 49562

(220) 08/01/2024

(732) Beijing Wide Technology Co., Ltd.

(Yizhuang Group, High-end Industrial Zone of Beijing Pilot Free Trade Zone) 101, Floor 1-5, Building 4, Zone 3, No.88, Jinghai Fifth Road, Beijing Economic and Technological Development Zone, Beijing, China

(111) No. 61998

(180) 08/01/2034

(540) Registration



(511) 06, 07, 09, 35, 37, 39, 40 and 42

(210) No. 49566

(220) 09/01/2024

(732) ATOZED OPTIMA CONSULTING

PTE.LTD.

8 EU TONG SEN STREET #14-83 THE CENTRAL SINGAPORE(059818)

(111) No. 61999

(180) 09/01/2034

(540) Registration

UPOWER

(511) 06, 09, 35, 37 and 40

(210) No. 49567

(220) 09/01/2024

(732) ATOZED OPTIMA CONSULTING
PTE.LTD.

8 EU TONG SEN STREET #14-83 THE
CENTRAL SINGAPORE(059818)

(111) No. 62000

(180) 09/01/2034

(540) Registration

PLPT POONG LIM PHARMATECH INC.

(511) 10

(210) No. 49570

(220) 10/01/2024

(732) PoongLim Pharmatech Inc.

Jayumuyeok Area, 21 Jayumuyeok 1-gil,
Gunsan-si, Jeollabuk-do, Republic Of Korea

(111) No. 62001

(180) 10/01/2034

(540) Registration

PLPT សេដ្ឋកិច្ច ធានាសុវត្ថិភាព **សេដ្ឋកិច្ច ធានាសុវត្ថិភាព**

(511) 03

(210) No. 49571

(220) 10/01/2024

(732) PoongLim Pharmatech Inc.

Jayumuyeok Area, 21 Jayumuyeok 1-gil,

Gunsan-si, Jeollabuk-do, Republic Of Korea

(111) No. 62002

(180) 10/01/2034

(540) Registration

PLPT សេដ្ឋកិច្ច ធានាសុវត្ថិភាព **សេដ្ឋកិច្ច ធានាសុវត្ថិភាព**

(511) 35

(210) No. 49572

(220) 10/01/2024

(732) PoongLim Pharmatech Inc.

Jayumuyeok Area, 21 Jayumuyeok 1-gil,

Gunsan-si, Jeollabuk-do, Republic Of Korea

(111) No. 62003

(180) 10/01/2034

(540) Registration



(511) 06

(210) No. 49574

(220) 10/01/2024

(732) CHINA RAILWAY CONTAINER
TRANSPORT CORP., LTD
ROOM 510, NO. 24 YAZIQIAO RD.,
XICHENG DISTRICT, BEIJING 100055,
CHINA

(111) No. 62004

(180) 10/01/2034

(540) Registration



(511) 12

(210) No. 49575

(220) 10/01/2024

(732) CHINA RAILWAY CONTAINER
TRANSPORT CORP., LTD
ROOM 510, NO. 24 YAZIQIAO RD.,
XICHENG DISTRICT, BEIJING 100055,
CHINA

(111) No. 62005

(180) 10/01/2034

(540) Registration



(511) 35

(210) No. 49576

(220) 10/01/2024

(732) CHINA RAILWAY CONTAINER
TRANSPORT CORP., LTD
ROOM 510, NO. 24 YAZIQIAO RD.,
XICHENG DISTRICT, BEIJING 100055,
CHINA

(111) No. 62006

(180) 10/01/2034

(540) Registration



(511) 36

(210) No. 49577

(220) 10/01/2024

(732) CHINA RAILWAY CONTAINER
TRANSPORT CORP., LTD
ROOM 510, NO. 24 YAZIQIAO RD.,
XICHENG DISTRICT, BEIJING 100055,
CHINA

(111) No. 62007

(180) 10/01/2034

(540) Registration



(511) 39

(210) No. 49578

(220) 10/01/2024

(732) CHINA RAILWAY CONTAINER
TRANSPORT CORP., LTD
ROOM 510, NO. 24 YAZIQIAO RD.,
XICHENG DISTRICT, BEIJING 100055,
CHINA

(111) No. 62008

(180) 10/01/2034

(540) Registration



(511) 06

(210) No. 49579

(220) 10/01/2024

(732) CHINA RAILWAY CONTAINER
TRANSPORT CORP., LTD
ROOM 510, NO. 24 YAZIQIAO RD.,
XICHENG DISTRICT, BEIJING 100055,
CHINA

(111) No. 62009

(180) 10/01/2034

(540) Registration



(511) 12

(210) No. 49580

(220) 10/01/2024

(732) CHINA RAILWAY CONTAINER
TRANSPORT CORP., LTD
ROOM 510, NO. 24 YAZIQIAO RD.,
XICHENG DISTRICT, BEIJING 100055,
CHINA

(111) No. 62010

(180) 10/01/2034

(540) Registration



(511) 35

(210) No. 49581

(220) 10/01/2024

(732) CHINA RAILWAY CONTAINER
TRANSPORT CORP., LTD
ROOM 510, NO. 24 YAZIQIAO RD.,
XICHENG DISTRICT, BEIJING 100055,
CHINA

(111) No. 62011

(180) 10/01/2034

(540) Registration



(511) 36

(210) No. 49582

(220) 10/01/2024

(732) CHINA RAILWAY CONTAINER
TRANSPORT CORP., LTD
ROOM 510, NO. 24 YAZIQIAO RD.,
XICHENG DISTRICT, BEIJING 100055,
CHINA

(111) No. 62012

(180) 10/01/2034

(540) Registration



(511) 39

(210) No. 49583

(220) 10/01/2024

(732) CHINA RAILWAY CONTAINER
TRANSPORT CORP., LTD
ROOM 510, NO. 24 YAZIQIAO RD.,
XICHENG DISTRICT, BEIJING 100055,
CHINA

(111) No. 62013

(180) 10/01/2034

(540) Registration



(511) 35

(210) No. 49584

(220) 10/01/2024

(732) ABSOLUTE HOTEL SERVICES CO., LTD.

No. 571 RSU Tower, 9th Floor, Unit 903, Soi

Sukhumvit 31, Sukhumvit Road, Kwang

Khlong Tan Nuea, Khet Watthana, Bangkok,

10110, Thailand

(111) No. 62014

(180) 10/01/2034

(540) Registration



(511) 43

(210) No. 49585

(220) 10/01/2024

(732) ABSOLUTE HOTEL SERVICES CO., LTD.

No. 571 RSU Tower, 9th Floor, Unit 903, Soi

Sukhumvit 31, Sukhumvit Road, Kwang

Khlong Tan Nuea, Khet Watthana, Bangkok,

10110, Thailand

(111) No. 62015

(180) 10/01/2034

(540) Registration



(511) 44

(210) No. 49586

(220) 10/01/2024

(732) ABSOLUTE HOTEL SERVICES CO., LTD.

No. 571 RSU Tower, 9th Floor, Unit 903, Soi

Sukhumvit 31, Sukhumvit Road, Kwang

Khlong Tan Nuea, Khet Watthana, Bangkok,

10110, Thailand

(111) No. 62016

(180) 10/01/2034

(540) Registration



(511) 34

(210) No. 49588

(220) 12/01/2024

(732) PAX INNOVATIONS (SHENZHEN)

LIMITED

RM 808, Block A, Bldg 2, Tongtai Times

Centre, Haoye Rd, Bao'an District, Shenzhen,

China

(111) No. 62017

(180) 12/01/2034

(540) Registration

KAITASHI

(511) 10

(210) No. 49589

(220) 12/01/2024

(732) VO VAN TAI

Lot OBT1, Plot No. 20 Northern Linh Dam
Expansion, Dai Kim Ward, Hoang Mai
District, Hanoi City, Vietnam

(111) No. 62018

(180) 12/01/2034

(540) Registration

 **NewRixing**

(511) 09

(210) No. 49591

(220) 12/01/2024

(732) DongGuan LeTu Electronic Technology Co.,
Ltd.

No.4 Industrial Yilu, Xiakeng Village,
Changping Town, Dongguan City,
Guangdong Province, China

(111) No. 62019

(180) 12/01/2034

(540) Registration

YAMAGUCHI

(511) 10

(210) No. 49592

(220) 12/01/2024

(732) VO VAN TAI

Lot OBT1, Plot No. 20 Northern Linh Dam
Expansion, Dai Kim Ward, Hoang Mai
District, Hanoi City, Vietnam

(111) No. 62020

(180) 12/01/2034

(540) Registration

ANGLOMOIL

(511) 01 and 04

(210) No. 49593

(220) 15/01/2024

(732) LUU GIA NU

T4, A37.09, 159 Hanoi Highway, Thao Dien
Ward, Thu Duc City, Ho Chi Minh City,
Vietnam

(111) No. 62021

(180) 15/01/2034

(540) Registration

Karseell

(511) 03

(210) No. 49599

(220) 16/01/2024

(732) Guangzhou Chinchy Cosmetics Co.,Ltd.
Room 1616,No.395, Jianpeng road, Helong
street,Baiyun District, guangzhou, 510000,
China

(111) No. 62022

(180) 16/01/2034

(540) Registration

Biostime

(511) 30, 31 and 32

(210) No. 49600

(220) 17/01/2024

(732) Health and Happiness (H&H) Hong Kong
Limited
SUITES 4007-09 40/F, ONE ISLAND EAST
TAIKOO PLACE, 18 WESTLANDS ROAD
QUARRY BAY, HONG KONG

(111) No. 62023

(180) 17/01/2034

(540) Registration



(511) 29, 30, 31 and 32

(210) No. 49601

(220) 17/01/2024

(732) Health and Happiness (H&H) Hong Kong
Limited

SUITES 4007-09 40/F, ONE ISLAND EAST
TAIKOO PLACE, 18 WESTLANDS ROAD
QUARRY BAY, HONG KONG

(111) No. 62024

(180) 17/01/2034

(540) Registration



(511) 41

(210) No. 49602

(220) 17/01/2024

(732) Health and Happiness (H&H) Hong Kong
Limited

SUITES 4007-09 40/F, ONE ISLAND EAST
TAIKOO PLACE, 18 WESTLANDS ROAD
QUARRY BAY, HONG KONG

(111) No. 62025

(180) 17/01/2034

(540) Registration



(511) 41

(210) No. 49603

(220) 17/01/2024

(732) Health and Happiness (H&H) Hong Kong
Limited

SUITES 4007-09 40/F, ONE ISLAND EAST
TAIKOO PLACE, 18 WESTLANDS ROAD
QUARRY BAY, HONG KONG

(111) No. 62026

(180) 17/01/2034

(540) Registration



(511) 30

(210) No. 49604

(220) 17/01/2024

(732) Aalst Chocolate Pte Ltd

26 Tuas Avenue 7, Singapore 639273

(111) No. 62027

(180) 17/01/2034

(540) Registration

HYPER GRAPFINS

(511) 11

(210) No. 49607

(220) 17/01/2024

(732) Midea Group Co., Ltd.

B26-28F, Midea Headquarter Building, No.6

Midea Avenue, Beijiao, Shunde, Foshan,

Guangdong, China

(111) No. 62028

(180) 17/01/2034

(540) Registration



(511) 30

(210) No. 49608

(220) 17/01/2024

(732) ZHANG, SHENG

MIXUE Floor 1-2, J.market 64

Ngamwongwan Rd, Lat Yao, Chatuchak,

Bangkok 10900, Thailand

(111) No. 62029

(180) 17/01/2034

(540) Registration

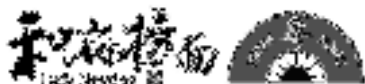

(511) 30, 35 and 43

(210) No. 49609

(220) 17/01/2024

(732) Jiangsu Hefu Restaurant Management Co.,
Ltd.

GROUP 5, LU MEN COMMUNITY,
CHENGBEI STREET, RUGAO ,
NANTONG, JIANGSU PROVINCE,
CHINA

(111) No. 62030

(180) 17/01/2034

(540) Registration

Midea PRO SHOP

(511) 11

(210) No. 49612

(220) 18/01/2024

(732) Midea Group Co., Ltd.

B26-28F, Midea Headquarter Building, No.6
Midea Avenue, Beijiao, Shunde, Foshan,
Guangdong, China

(111) No. 62031

(180) 18/01/2034

(540) Registration

Midea PRO SHOP

(511) 35

(210) No. 49613

(220) 18/01/2024

(732) Midea Group Co., Ltd.

B26-28F, Midea Headquarter Building, No.6

Midea Avenue, Beijiao, Shunde, Foshan,

Guangdong, China

(111) No. 62032

(180) 18/01/2034

(540) Registration

KZNEED

(511) 12

(210) No. 49616

(220) 19/01/2024

(732) Hangzhou Kuaizhun Auto Parts E-Business
co.,Ltd

Room 1503-1504, Building 3, Haichuang

Science and Technology Center, Cangqian

Street, Yuhang district, Hangzhou City,

Zhejiang Province, China

(111) No. 62033

(180) 19/01/2034

(540) Registration



(511) 01, 04, 07, 09, 12 and 17

(210) No. 49617

(220) 19/01/2024

(732) Hangzhou Kuaizhun Auto Parts E-Business
co.,Ltd

Room 1503-1504, Building 3, Haichuang
Science and Technology Center, Cangqian
Street, Yuhang district, Hangzhou City,
Zhejiang Province, China

(111) No. 62034

(180) 19/01/2034

(540) Registration



(511) 01, 04, 07, 09, 12 and 17

(210) No. 49618

(220) 19/01/2024

(732) Hangzhou Kuaizhun Auto Parts E-Business
co.,Ltd

Room 1503-1504, Building 3, Haichuang
Science and Technology Center, Cangqian
Street, Yuhang district, Hangzhou City,
Zhejiang Province, China

(111) No. 62035

(180) 19/01/2034

(540) Registration

Mooekiss

(511) 03 and 21

(210) No. 49619

(220) 19/01/2024

(732) ZHEJIANG KEMO NETWORK
TECHNOLOGY CO., LTD.

Room 203, 2nd Floor, Hengding Building, No.
597 Bin'an Road, Changhe Street, Binjiang
District, Hangzhou, China (Zhejiang) Pilot
Free Trade Zone, China

(111) No. 62036

(180) 19/01/2034

(540) Registration

蜀大侠

(511) 29, 30 and 43

(210) No. 49621

(220) 19/01/2024

(732) Chengdu Shudaxia Catering Management
Co., Ltd

No. 12, Floor 5, No. 207, Xiyulong Street,
Qingyang District, Chengdu, Sichuan
Province, China

(111) No. 62037

(180) 19/01/2034

(540) Registration



(511) 29, 30 and 43

(210) No. 49622

(220) 19/01/2024

(732) Chengdu Shudaxia Catering Management
Co., Ltd

No. 12, Floor 5, No. 207, Xiyulong Street,
Qingyang District, Chengdu, Sichuan
Province, China

(111) No. 62038

(180) 19/01/2034

(540) Registration

SHUDAXIA HOT POT

(511) 29, 30 and 43

(210) No. 49623

(220) 19/01/2024

(732) Chengdu Shudaxia Catering Management
Co., Ltd

No. 12, Floor 5, No. 207, Xiyulong Street,
Qingyang District, Chengdu, Sichuan
Province, China

(111) No. 62039

(180) 19/01/2034

(540) Registration

AIYISHI

(511) 14

(210) No. 49624

(220) 19/01/2024

(732) GUANGZHOU AIYISHI TRADING CO.,
LTD.

No. 2282, Floor 16, Xingguangyingjing, No.
119, Shuiyin Road, Yuexiu District,
Guangzhou City, Guangdong Province, China

(111) No. 62040

(180) 19/01/2034

(540) Registration



(511) 35

(210) No. 49625

(220) 19/01/2024

(732) HUNAN BUSY FOR YOU COMMERCIAL
CHAIN CO., LTD.

33001-33006, Yunda Central Plaza II
Commercial Complex Building, No. 567,
Changsha Avenue, Yuhua District, Changsha
City, Hunan Province, China

(111) No. 62041

(180) 19/01/2034

(540) Registration



(511) 09

(210) No. 49627

(220) 23/01/2024

(732) Clarios Technology and Recycling GmbH

Am Leineufer 51, 30419 Hannover, Germany

(111) No. 62042

(180) 23/01/2034

(540) Registration

FENESTRON

(511) 12

(210) No. 49629

(220) 23/01/2024

(732) AIRBUS HELICOPTERS

Aéroport International Marseille Provence,

13725 Marignane Cedex, France

(111) No. 62043

(180) 23/01/2034

(540) Registration

ECUREUIL

(511) 12

(210) No. 49630

(220) 23/01/2024

(732) AIRBUS HELICOPTERS

Aéroport International Marseille Provence,
13725 Marignane Cedex, France

(111) No. 62044

(180) 23/01/2034

(540) Registration

DAUPHIN

(511) 12

(210) No. 49631

(220) 23/01/2024

(732) AIRBUS HELICOPTERS

Aéroport International Marseille Provence,
13725 Marignane Cedex, France

(111) No. 62045

(180) 23/01/2034

(540) Registration

SPHERIFLEX

(511) 07 and 12

(210) No. 49632

(220) 23/01/2024

(732) AIRBUS HELICOPTERS

Aéroport International Marseille Provence,
13725 Marignane Cedex, France

(111) No. 62046

(180) 23/01/2034

(540) Registration

STARFLEX

(511) 07 and 12

(210) No. 49633

(220) 23/01/2024

(732) AIRBUS HELICOPTERS

Aéroport International Marseille Provence,
13725 Marignane Cedex, France

(111) No. 62047

(180) 23/01/2034

(540) Registration



(511) 29 and 30

(210) No. 49636

(220) 24/01/2024

(732) CJ CHEILJEDANG CORPORATION
CJ Cheiljedang Center, 330, Dongho-ro,
Jung-gu, Seoul, Republic Of Korea

(111) No. 62048

(180) 24/01/2034

(540) Registration

Temple hotels and resorts

(511) 43

(210) No. 49638

(220) 25/01/2024

(732) Julian Roberto Ongpin
7232 Ayala Avenue Ext., Bel-Air, Makati,
Metropolitan Manila, 1209, Philippines

(111) No. 62049

(180) 25/01/2034

(540) Registration

SALOMON

(511) 18, 25 and 35

(210) No. 49639

(220) 25/01/2024

(732) SALOMON S.A.S.

14 Chemin des Croiselets ZA des Croiselets

74370 Epagny Metz-Tessy, France

(111) No. 62050

(180) 25/01/2034

(540) Registration

Yiwu Market

(511) 20

(210) No. 49640

(220) 25/01/2024

(732) Zhejiang China Commodities City Group Co.,

Ltd.

Ocean Business Building, No.105 Futian Road,

Yiwu City, Zhejiang Province, China

(111) No. 62051

(180) 25/01/2034

(540) Registration



(511) 20

(210) No. 49641

(220) 25/01/2024

(732) Zhejiang China Commodities City Group Co.,
Ltd.

Ocean Business Building, No.105 Futian
Road, Yiwu City, Zhejiang Province, China

(111) No. 62052

(180) 25/01/2034

(540) Registration

SHUDAXIA HOT POT

(511) 30

(210) No. 49642

(220) 25/01/2024

(732) Chengdu Shudaxia Catering Management
Co., Ltd.

No. 12, Floor 5, No. 207, Xiyulong Street,
Qingyang District, Chengdu, Sichuan
Province, China

(111) No. 62053

(180) 25/01/2034

(540) Registration

SHUDAXIA HOT POT

(511) 43

(210) No. 49643

(220) 25/01/2024

(732) Chengdu Shudaxia Catering Management
Co., Ltd.

No. 12, Floor 5, No. 207, Xiyulong Street,
Qingyang District, Chengdu, Sichuan
Province, China

(111) No. 62054

(180) 25/01/2034

(540) Registration



(511) 43

(210) No. 49644

(220) 25/01/2024

(732) Chengdu Shudaxia Catering Management
Co., Ltd.

No. 12, Floor 5, No. 207, Xiyulong Street,
Qingyang District, Chengdu, Sichuan
Province, China

(111) No. 62055

(180) 25/01/2034

(540) Registration

蜀大侠

(511) 30

(210) No. 49645

(220) 25/01/2024

(732) Chengdu Shudaxia Catering Management
Co., Ltd.

No. 12, Floor 5, No. 207, Xiyulong Street,
Qingyang District, Chengdu, Sichuan
Province, China

(111) No. 62056

(180) 25/01/2034

(540) Registration

蜀大侠

(511) 43

(210) No. 49646

(220) 25/01/2024

(732) Chengdu Shudaxia Catering Management
Co., Ltd.

Chengdu Shudaxia Catering Management
Co., Ltd.No. 12, Floor 5, No. 207, Xiyulong
Street, Qingyang District, Chengdu, Sichuan
Province, China

(111) No. 62057

(180) 25/01/2034

(540) Registration

LIRAGET

(511) 05

(210) No. 49647

(220) 25/01/2024

(732) Getz Pharma International FZ LLC

Office No. 1307, 13th Floor, Al-Thuraya

Tower 1, Dubai Media City, Dubai,

U.A.E, P.O. Box: 345018, Dubai,

United Arab Emirates

(111) No. 62058

(180) 25/01/2034

(540) Registration



(511) 30

(210) No. 49648

(220) 25/01/2024

(732) Chengdu Shudaxia Catering Management

Co., Ltd.

No. 12, Floor 5, No. 207, Xiyulong Street,

Qingyang District, Chengdu,

Sichuan Province, China

(111) No. 62059

(180) 25/01/2034

(540) Registration

The logo for Hankook, featuring a stylized orange flame-like symbol to the left of the word "HANKOOK" in a bold, black, sans-serif font.

(511) 09

(210) No. 49655

(220) 29/01/2024

(732) HANKOOK & COMPANY CO., LTD.
286, Pangyo-ro, Bundang-gu, Seongnam-si,
Gyeonggi-do, Republic Of Korea

(111) No. 62060

(180) 29/01/2034

(540) Registration

The logo for Great Wall, featuring the words "Great Wall" in a bold, red, sans-serif font.

(511) 09

(210) No. 49656

(220) 29/01/2024

(732) CHINA ELECTRONICS CORPORATION
Building A, Tri-Tower, No. 66-1,
Zhongguancun East Road, Haidian District,
BeiJing 100190, China

(111) No. 62061

(180) 29/01/2034

(540) Registration

SKYLARK

(511) 09, 38 and 42

(210) No. 49658

(220) 30/01/2024

(732) NINGBO ZHIHUI NETWORK
TECHNOLOGY CO., LTD.

9-17, No.76 Zhenxing North Road, Yishi
Village, Yishi Town, Ninghai County,
Ningbo City, Zhejiang Province, China

(111) No. 62062

(180) 30/01/2034

(540) Registration

MORIZO

(511) 12

(210) No. 49659

(220) 30/01/2024

(732) TOYOTA JIDOSHA KABUSHIKI KAISHA
(also trading as TOYOTA MOTOR
CORPORATION)

1, Toyota-cho, Toyota-shi, Aichi-ken, Japan

(111) No. 62063

(180) 30/01/2034

(540) Registration



(511) 09

(210) No. 49660

(220) 30/01/2024

(732) Jiangsu Bangwei Optical Glasses Co., Ltd.
319 Yuquan Street, Kaifa District, Danyang
City, Jiangsu Province, 212300, China

(111) No. 62064

(180) 30/01/2034

(540) Registration

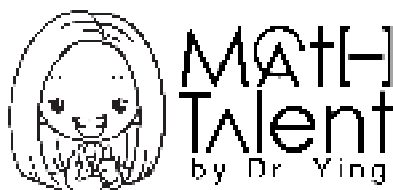

(511) 41

(210) No. 49661

(220) 30/01/2024

(732) MATH TALENT COMPANY LIMITED
254 Wittayakit Building Fl. 18, Phaya Thai
Rd., Pathumwan Sub-district, Pathumwan
District, Bangkok 10330, Thailand

(111) No. 62065

(180) 30/01/2034

(540) Registration

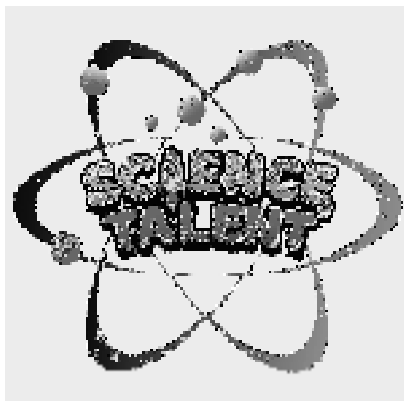

(511) 41

(210) No. 49662

(220) 30/01/2024

(732) MATH TALENT COMPANY LIMITED

254 Wittayakit Building Fl. 18, Phaya Thai
Rd., Pathumwan Sub-district, Pathumwan
District, Bangkok 10330, Thailand

(111) No. 62066

(180) 30/01/2034

(540) Registration

(511) 18

(210) No. 49665

(220) 30/01/2024

(732) GUANGZHOU ZIXI MANAGEMENT
SERVICES CO., LTD.

Suite 907, 8#, Kaitai Avenue, Huangpu
District, Guangzhou, China

(111) No. 62067

(180) 30/01/2034

(540) Registration

Cabbeen

(511) 25

(210) No. 49666

(220) 30/01/2024

(732) GUANGZHOU ZIXI MANAGEMENT
SERVICES CO., LTD.

Suite 907, 8#, Kaitai Avenue, Huangpu
District, Guangzhou, China

(111) No. 62068

(180) 30/01/2034

(540) Registration

卡宾

(511) 18

(210) No. 49667

(220) 30/01/2024

(732) GUANGZHOU ZIXI MANAGEMENT
SERVICES CO., LTD.

Suite 907, 8#, Kaitai Avenue, Huangpu
District, Guangzhou, China

(111) No. 62069

(180) 30/01/2034

(540) Registration



(511) 25

(210) No. 49668

(220) 30/01/2024

(732) GUANGZHOU ZIXI MANAGEMENT
SERVICES CO., LTD.

Suite 907, 8#, Kaitai Avenue, Huangpu
District, Guangzhou, China

(111) No. 62070

(180) 30/01/2034

(540) Registration



(511) 18

(210) No. 49669

(220) 30/01/2024

(732) GUANGZHOU ZIXI MANAGEMENT
SERVICES CO., LTD.

Suite 907, 8#, Kaitai Avenue, Huangpu
District, Guangzhou, China

(111) No. 62071

(180) 30/01/2034

(540) Registration



(511) 25

(210) No. 49670

(220) 30/01/2024

(732) GUANGZHOU ZIXI MANAGEMENT SERVICES CO., LTD.

Suite 907, 8#, Kaitai Avenue, Huangpu District, Guangzhou, China

(111) No. 62072

(180) 30/01/2034

(540) Registration



(511) 03

(210) No. 49674

(220) 31/01/2024

(732) BIZ ON DEMAND CO., LTD.

120/5 Soi Ngamwongwan 43 (Chin Khet 1), Thung Song Hong Subdistrict, Lak Si District, Bangkok 10210, Thailand

(111) No. 62073

(180) 31/01/2034

(540) Registration

The logo for CIVAGO is rendered in a bold, black, pixelated font. The letters are blocky and have a slightly irregular, digital appearance.

(511) 21

(210) No. 49675

(220) 31/01/2024

(732) XIAO TAO

Room 1602, Building 5, Dongfang No.1
Apartment, Xiaoshan Economic and
Technological Development Zone,
Xiaoshan District, Hangzhou, China

(111) No. 62074

(180) 31/01/2034

(540) Registration

The logo for 小龙坎 (XIAOLONGKAN) features the Chinese characters in a bold, black, pixelated font. To the right of the characters, the English name 'XIAOLONGKAN' is written in a smaller, black, pixelated font, with 'XIAO' on the top line, 'LONG' in the middle, and 'KAN' on the bottom line.

(511) 43

(210) No. 49676

(220) 31/01/2024

(732) CHENGDU XIAOLONGKAN CATERING
MANAGEMENT CO., LTD.

Attached No.1, No.201, 2/F, Unit1, No.50,
DongDaJie, Jinjiang Dist., Chengdu, Sichuan,
China

(111) No. 62075

(180) 31/01/2034

(540) Registration

小龙坎
SHOO LOONG KAN

(511) 43

(210) No. 49677

(220) 31/01/2024

(732) CHENGDU XIAOLONGKAN CATERING
MANAGEMENT CO., LTD.

Attached No.1, No.201, 2/F, Unit1, No.50,
DongDaJie, Jinjiang Dist., Chengdu, Sichuan,
China

(111) No. 62076

(180) 31/01/2034

(540) Registration



(511) 03

(210) No. 49678

(220) 31/01/2024

(732) ERIKA12(THAILAND) LIMITED
PARTNERSHIP.

194/7-8 Tha Kham Road, Samae Dam
Subdistrict, Bang Khun Thian District
Bangkok 10150, Thailand

(111) No. 62077

(180) 31/01/2034

(540) Registration



(511) 37

(210) No. 49614

(220) 19/01/2024

(732) ວິສາຫະກິດສ່ວນບຸກຄົນ ສີໄຊ ກໍ່ສ້າງ

ບ້ານ ຮ່ອງຄ້າ, ເມືອງ ຈັນທະບູລີ,

ນະຄອນຫຼວງວຽງຈັນ, ສປປ ລາວ

(111) No. 62078

(180) 19/01/2034

(540) Registration



(511) 02 and 19

(210) No. 49615

(220) 19/01/2024

(732) ບໍລິສັດ ລາງດູ ອິນຕັສທຣຽນ ຈຳກັດຜູ້ດຽວ

ບ້ານ ຕານມີໄຊ, ເມືອງ ໄຊທານີ,

ນະຄອນຫຼວງວຽງຈັນ, ສປປ ລາວ

(111) No. 62079

(180) 19/01/2034

(540) Registration



(511) 12 and 35

(210) No. 49620

(220) 19/01/2024

(732) ບໍລິສັດ ເຊິ່ງຄັງການຄ້າ ຈຳກັດຜູ້ດຽວ
ບ້ານ ວັດໄຕນ້ອຍທົ່ງ, ເມືອງ ສີໂຄດຕະບອງ,
ນະຄອນຫຼວງວຽງຈັນ, ສປປ ລາວ

(111) No. 62080

(180) 19/01/2034

(540) Registration



(511) 43

(210) No. 49626

(220) 22/01/2024

(732) ບໍລິສັດ ກິນດີມຕ້າຫຼິງຢ່ຽນລາວ ຈຳກັດຜູ້ດຽວ
ບ້ານເພຍວັດ, ເມືອງສີສັດຕະນາກ,
ນະຄອນຫຼວງວຽງຈັນ, ສປປ ລາວ

(111) No. 62081

(180) 22/01/2034

(540) Registration



(511) 09 and 35

(210) No. 49628

(220) 23/01/2024

(732) ບໍລິສັດ ຫົວຊິງ ອຸປະກອນເສີມດິຈິຕອນເອເລັກໂຕຣນິກ
ຈຳກັດຜູ້ດຽວ

ບ້ານ ດົງປາລານທ່າ, ເມືອງ ສີສັດຕະນາກ,

ນະຄອນຫຼວງວຽງຈັນ, ສປປ ລາວ

(111) No. 62082

(180) 23/01/2034

(540) Registration



(511) 32

(210) No. 49634

(220) 24/01/2024

(732) ບໍລິສັດ ເບຍສິດເພນກວິນລາວ ຈຳກັດຜູ້ດຽວ

ບ້ານດອນມຸນ, ເມືອງ ຕົ້ນເຜີ້ງ, ແຂວງ ບໍ່ແກ້ວ,

ສປປ ລາວ

(111) No. 62083

(180) 24/01/2034

(540) Registration



(511) 30

(210) No. 49637

(220) 24/01/2024

(732) ບ້ານກະແລ້ມ

ບ້ານ ບຶງຂະຫຍອງ, ເມືອງ ສີສັດຕະນາກ,

ນະຄອນຫຼວງວຽງຈັນ, ສປປ ລາວ

(111) No. 62084

(180) 24/01/2034

(540) Registration



(511) 34

(210) No. 49649

(220) 27/01/2024

(732) ບໍລິສັດ ຮຸ້ນສ່ວນການຄ້າ ແລະ ກໍ່ສ້າງເຕີຍໂຕ II ຈຳກັດ

ບ້ານ ນາມອນ, ເມືອງ ວຽງໄຊ, ແຂວງ ຫົວພັນ, ສປປ

ລາວ

(111) No. 62085

(180) 27/01/2034

(540) Registration



(511) 34

(210) No. 49650

(220) 27/01/2024

(732) ບໍລິສັດ ຮຸ້ນສ່ວນການຄ້າ ແລະ ກໍ່ສ້າງເຕີຍໂດ II ຈຳກັດ
ບ້ານ ນາມອນ, ເມືອງ ວຽງໄຊ, ແຂວງ ຫົວພັນ,
ສປປ ລາວ

(111) No. 62086

(180) 27/01/2034

(540) Registration



(511) 34

(210) No. 49651

(220) 27/01/2024

(732) ບໍລິສັດ ຮຸ້ນສ່ວນການຄ້າ ແລະ ກໍ່ສ້າງເຕີຍໂດ II ຈຳກັດ
ບ້ານ ນາມອນ, ເມືອງ ວຽງໄຊ, ແຂວງ ຫົວພັນ,
ສປປ ລາວ

(111) No. 62087

(180) 27/01/2034

(540) Registration



(511) 35

(210) No. 49652

(220) 29/01/2024

(732) ບໍລິສັດ ຄະຕະລິສ ພານິສ ຈຳກັດຜູ້ດຽວ

ຖະນົນ ດົງປາຍນາ, ບ້ານ ສະພານທອງເໜືອ,

ເມືອງ ສີສັດຕະນາກ, ນະຄອນຫຼວງວຽງຈັນ, ສປປ ລາວ

(111) No. 62088

(180) 29/01/2034

(540) Registration



(511) 35

(210) No. 49653

(220) 29/01/2024

(732) ບໍລິສັດ ຄະຕະລິສ ພານິສ ຈຳກັດຜູ້ດຽວ

ຖະນົນ ດົງປາຍນາ, ບ້ານ ສະພານທອງເໜືອ,

ເມືອງ ສີສັດຕະນາກ, ນະຄອນຫຼວງວຽງຈັນ, ສປປ ລາວ

(111) No. 62089

(180) 29/01/2034

(540) Registration



(511) 41

(210) No. 49654

(220) 29/01/2024

(732) ບໍລິສັດ ຄະຕະລິສ ພານິສ ຈຳກັດຜູ້ດຽວ
ຖະນົນ ດົງປາຍນາ, ບ້ານ ສະພານທອງເໜືອ,
ເມືອງ ສີສັດຕະນາກ, ນະຄອນຫຼວງວຽງຈັນ, ສປປ ລາວ

(111) No. 62090

(180) 29/01/2034

(540) Registration



(511) 29

(210) No. 49657

(220) 30/01/2024

(732) ໂຮງງານຜະລິດນ້ຳແຈ່ວ ນາມມິໄຊ ສ່ວນບຸກຄົນ
ບ້ານ ຊຽງດາ ເມືອງ ໄຊທານີ, ນະຄອນຫຼວງວຽງຈັນ,
ສປປ ລາວ

(111) No. 62091

(180) 30/01/2034

(540) Registration



(511) 34

(210) No. 49663

(220) 30/01/2024

(732) ບໍລິສັດ ຮຸ້ນສ່ວນການຄ້າ ແລະ ກໍ່ສ້າງເຕີຍ II ຈຳກັດ

ບ້ານ ນາມອນ, ເມືອງ ວຽງໄຊ, ແຂວງ ຫົວພັນ,

ສປປ ລາວ

(111) No. 62092

(180) 30/01/2034

(540) Registration



(511) 34

(210) No. 49664

(220) 30/01/2024

(732) ບໍລິສັດ ຮຸ້ນສ່ວນການຄ້າ ແລະ ກໍ່ສ້າງເຕີຍໂຕ II ຈຳກັດ

ບ້ານ ນາມອນ, ເມືອງ ວຽງໄຊ, ແຂວງ ຫົວພັນ,

ສປປ ລາວ

(111) No. 62093

(180) 30/01/2034

(540) Registration



(511) 39

(210) No. 49671

(220) 30/01/2024

(732) ບໍລິສັດ ມຸມໃຈທອງທ່ຽວ

ບ້ານ ບໍ່, ເມືອງ ໄຊ, ແຂວງ ອຸດົມໄຊ, ສປປ ລາວ

(111) No. 62094

(180) 30/01/2034

(540) Registration



(511) 45

(210) No. 49672

(220) 30/01/2024

(732) ບໍລິສັດ ມຸມໃຈບໍລິການເອກະສານ ຈຳກັດຜູ້ດຽວ

ບ້ານ ບໍ່, ເມືອງ ໄຊ, ແຂວງ ອຸດົມໄຊ, ສປປ ລາວ

(111) No. 62095

(180) 30/01/2034

(540) Registration



(511) 31

(210) No. 49673

(220) 30/01/2024

(732) ບໍລິສັດ ລາວຕິງເຊິງ ສິ່ງເສີມການກະເສດ ແລະ ຂາເຂົ້າ-
ຂາອອກ ຈຳກັດ

ບ້ານ ນາຄຳ, ເມືອງ ສີໂຄດຕະບອງ,

ນະຄອນຫຼວງວຽງຈັນ, ສປປ ລາວ

(111) No. 62096

(180) 30/01/2034

(540) Registration



(511) 35 and 39

(210) No. 49550

(220) 03/01/2024

(732) ບໍລິສັດ ຈະເລີນ ດິສທິວບົວຊັນ ສິສເຕັມ ຈຳກັດຜູ້ດຽວ

ບ້ານ ທາດຫຼວງກາງ, ເມືອງ ໄຊເສດຖາ,

ນະຄອນຫຼວງວຽງຈັນ, ສປປ ລາວ

(111) No. 62097

(180) 03/01/2034

(540) Registration



(511) 29

(210) No. 49551

(220) 03/01/2024

(732) ບໍລິສັດ ເມືອງລາວ ຈຳກັດຜູ້ດຽວ
ບ້ານ ໂຊກຄຳ, ເມືອງ ໄຊເສດຖາ,
ນະຄອນຫຼວງວຽງຈັນ, ສປປ ລາວ

(111) No. 62098

(180) 03/01/2034

(540) Registration



(511) 12

(210) No. 49552

(220) 05/01/2024

(732) ບໍລິສັດ ຫັງແຈລິດຈັກ ຈຳກັດຜູ້ດຽວ
ບ້ານ ໃໝ່, ເມືອງ ສີໂຄດຕະບອງ,
ນະຄອນຫຼວງວຽງຈັນ, ສປປ ລາວ

(111) No. 62099

(180) 05/01/2034

(540) Registration



(511) 12

(210) No. 49553

(220) 05/01/2024

(732) ບໍລິສັດ ຫັງແຈລິດຈິກ ຈຳກັດຜູ້ດຽວ

ບ້ານໃໝ່, ເມືອງ ສີໂຄດຕະບອງ, ນະຄອນຫຼວງວຽງຈັນ,
ສປປ ລາວ

(111) No. 62100

(180) 05/01/2034

(540) Registration



(511) 32

(210) No. 49555

(220) 05/01/2024

(732) ໂຮງງານນໍ້າດື່ມ ແລະ ນໍ້າກ້ອນ ເຄເອັສ ສ່ວນບຸກຄົນ.

ຖະໜົນ 13 ໃຕ້, ບ້ານ ດ່ານຮີ, ເມືອງ ຫີນບູນ,
ແຂວງ ຄຳມ່ວນ, ສປປ ລາວ

(111) No. 62101

(180) 05/01/2034

(540) Registration



(511) 29, 30 and 35

(210) No. 49556

(220) 05/01/2024

(732) ບໍລິສັດ ເສັ້ນຫລີຢຽນ ນໍາເຂົ້າ-ສົ່ງອອກ ຈໍາກັດ ຜູ້ດຽວ
ບ້ານ ດົງນາທອງ, ເມືອງ ສີໂຄດຕະບອງ,
ນະຄອນຫຼວງວຽງຈັນ, ສປປ ລາວ

(111) No. 62102

(180) 05/01/2034

(540) Registration



ຍອດຊາພູເບນິອ
Ngotsaphouneau

(511) 30

(210) No. 49558

(220) 08/01/2024

(732) ວິສາຫະກິດສ່ວນບຸກຄົນ
ໂຮງງານປຸງແຕ່ງຊາຂະໜາດນ້ອຍ ສຸກ ແສນຫານ
ບ້ານ ມົງເຈົ້າ, ເມືອງ ຜົ້ງສາລີ, ແຂວງ ຜົ້ງສາລີ,
ສປປ ລາວ

(111) No. 62103

(180) 08/01/2034

(540) Registration

KNINE

(511) 12

(210) No. 49568

(220) 10/01/2024

(732) ບໍລິສັດ ເຄອິສະຕາ ນໍາເຂົ້າ ແລະ ສົ່ງອອກ ຈຳກັດຜູ້ດຽວ

ບ້ານ ທາດຫຼວງໃຕ້, ເມືອງ ໄຊເສດຖາ,

ນະຄອນຫຼວງວຽງຈັນ, ສປປ ລາວ

(111) No. 62104

(180) 10/01/2034

(540) Registration

BIGGER

(511) 12

(210) No. 49569

(220) 10/01/2024

(732) ບໍລິສັດ ເຄອິສະຕາ ນໍາເຂົ້າ ແລະ ສົ່ງອອກ ຈຳກັດຜູ້ດຽວ

ບ້ານ ທາດຫຼວງໃຕ້, ເມືອງ ໄຊເສດຖາ,

ນະຄອນຫຼວງວຽງຈັນ, ສປປ ລາວ

(111) No. 62105

(180) 10/01/2034

(540) Registration



(511) 03

(210) No. 49573

(220) 10/01/2024

(732) ບໍລິສັດ ຍາຈີ ແຟັບ + ສະໄລ ຈຳກັດ

ບ້ານ ຊ່າງໄຫ, ເມືອງ ປາກອູ, ແຂວງ ຫຼວງພະບາງ

(111) No. 62106

(180) 10/01/2034

(540) Registration



(511) 44

(210) No. 49587

(220) 11/01/2024

(732) ສຸນເສີມຄວາມງາມ ແຊນຕີ້ ຈຳກັດຜູ້ດຽວ

ບ້ານ ຈອມມະນີ, ເມືອງ ໄຊເສດຖາ,

ນະຄອນຫຼວງວຽງຈັນ, ສປປ ລາວ

(111) No. 62107

(180) 11/01/2034

(540) Registration



(511) 32

(210) No. 49594

(220) 15/01/2024

(732) ບໍລິສັດ ເບຍລາວ ຈຳກັດ

ຫຼັກ 12, ຖະໜົນທ່າເດື່ອ, ເມືອງ ຫາດຊາຍຝອງ,

ນະຄອນຫຼວງວຽງຈັນ, ສປປ ລາວ

(111) No. 62108

(180) 15/01/2034

(540) Registration

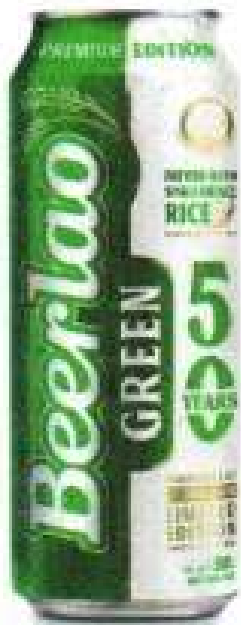

(511) 32

(210) No. 49595

(220) 15/01/2024

(732) ບໍລິສັດ ເບຍລາວ ຈຳກັດ

ຫຼັກ 12, ຖະໜົນທ່າເດື່ອ, ເມືອງ ຫາດຊາຍຝອງ,

ນະຄອນຫຼວງວຽງຈັນ, ສປປ ລາວ

(111) No. 62109

(180) 15/01/2034

(540) Registration



(511) 32

(210) No. 49596

(220) 15/01/2024

(732) ບໍລິສັດ ເບຍລາວ ຈຳກັດ

ຫຼັກ 12, ຖະໜົນທ່າເດື່ອ, ເມືອງ ຫາດຊາຍຝອງ,

ນະຄອນຫຼວງວຽງຈັນ, ສປປ ລາວ

(111) No. 62110

(180) 15/01/2034

ພາກທີ III
(Part III)
ເຄື່ອງໝາຍການຄ້າ
Trademarks

3. ການຕໍ່ອາຍຸ
(Renewal)

ຄຳອະທິບາຍກ່ຽວກັບລະຫັດຫຍໍ້
(Introduction of Codes)

- (540) ເຄື່ອງໝາຍການຄ້າ (Trademark)
- (511) ໝວດ (Nice Classification)
- (210) ເລກທີ ຄຳຮ້ອງ (Number of the application)
- (220) ວັນທີ ຄຳຮ້ອງ (Date of filing of the application)
- (732) ຊື່ ແລະ ທີ່ຢູ່ ຂອງຜູ້ຍື່ນຄຳຮ້ອງ (Name and Address of applicant)
- (111) ເລກທີການຈັດທະບຽນເຄື່ອງໝາຍການຄ້າ (Number of the registration)
- (180) ການຕໍ່ອາຍຸການຈັດທະບຽນ (Expiration date of the renewal)

ພາກທີ III

(Part III)

ເຄື່ອງໝາຍການຄ້າ

Trademarks

4. ການປ່ຽນແປງ

(Changes)

ພາກທີ III
(Part III)
ເຄື່ອງໝາຍການຄ້າ
Trademarks

5. ການດັດແກ້
(Amendments)

ພາກທີ IV

(Part IV)

ເຄື່ອງໝາຍການຄ້າຜ່ານລະບົບມາດຣິດ

Trademarks via Madrid Protocol

1. ຄໍາຮ້ອງ

(Applications)

ຄໍາອະທິບາຍກ່ຽວກັບລະຫັດຫຍໍ້

(Introduction of Codes)

- (540) ເຄື່ອງໝາຍການຄ້າ (Trademark)
- (511) ໝວດ (Nice Classification)
- (210) ເລກທີ ຄໍາຮ້ອງ (Number of the application)
- (220) ວັນທີ ຄໍາຮ້ອງ (Date of filing of the application)
- (732) ຊື່ ແລະ ທີ່ຢູ່ ຂອງຜູ້ຍື່ນຄໍາຮ້ອງ (Name and Address of applicant)

ພາກທີ IV

(Part IV)

ເຄື່ອງໝາຍການຄ້າຜ່ານລະບົບມາດຣິດ

Trademarks via Madrid Protocol

2. ຜົນການຈົດທະບຽນ

(Registration)

ຄຳອະທິບາຍກ່ຽວກັບລະຫັດຫຍໍ້

(Introduction of Codes)

- (540) ເຄື່ອງໝາຍການຄ້າ (Trademark)
- (511) ໝວດ (Nice Classification)
- (210) ເລກທີ ຄຳຮ້ອງ (Number of the application)
- (220) ວັນທີ ຍື່ນຄຳຮ້ອງ (Date of filing of the application)
- (732) ຊື່ ແລະ ທີ່ຢູ່ ຂອງຜູ້ຍື່ນຄຳຮ້ອງ (Name and Address of applicant)
- (111) ເລກທີການຈົດທະບຽນເຄື່ອງໝາຍການຄ້າ (Number of the registration)
- (180) ວັນໝົດອາຍຸຂອງການຈົດທະບຽນ (Expiration date of the registration)

ພາກທີ IV

(Part IV)

ເຄື່ອງໝາຍການຄ້າຜ່ານລະບົບມາດຣິດ

Trademarks via Madrid Protocol

3. ຜົນການຕໍ່ອາຍຸ

(Renewal)

ຄຳອະທິບາຍກ່ຽວກັບລະຫັດຫຍໍ້

(Introduction of Codes)

- (540) ເຄື່ອງໝາຍການຄ້າ (Trademark)
- (511) ໝວດ (Nice Classification)
- (210) ເລກທີ ຄຳຮ້ອງ (Number of the application)
- (220) ວັນທີ ຍື່ນຄຳຮ້ອງ (Date of filing of the application)
- (732) ຊື່ ແລະ ທີ່ຢູ່ ຂອງຜູ້ຍື່ນຄຳຮ້ອງ (Name and Address of applicant)
- (111) ເລກທີການຈົດທະບຽນເຄື່ອງໝາຍການຄ້າ (Number of the registration)
- (180) ການຕໍ່ອາຍຸຂອງການຈົດທະບຽນ (Expiration date of the renewal)

ພາກທີ IV

(Part IV)

ເຄື່ອງໝາຍການຄ້າຜ່ານລະບົບມາດຣິດ

Trademarks via Madrid Protocol

4. ການປ່ຽນແປງ

(Changes)

ພາກທີ IV

(Part IV)

ເຄື່ອງໝາຍການຄ້າຜ່ານລະບົບມາດຣິດ

Trademarks via Madrid Protocol

5. ການດັດແກ້

(Amendments)

ພາກທີ V
(Part V)
ຖິ່ນກຳເນີດ
Geographical Indications

1. ຄຳຮ້ອງ
(Applications)

ພາກທີ V
(Part V)
ຖິ່ນກຳເນີດ
Geographical Indications

2. ຜົນການຈົດທະບຽນ
(Registration)

ພາກທີ V
(Part V)
ຖິ່ນກຳເນີດ
Geographical Indications

2.1 ຜົນການຈັດທະບຽນ ຜ່ານລະບົບສາກົນ
(Lisbon Registration)

ພາກທີ V

(Part V)

ຖິ່ນກຳເນີດ

Geographical Indications

2.2 ຜົນການຈົດທະບຽນ ຊື່ຖິ່ນກຳເນີດສະເພາະ ຜ່ານລະບົບສາກົນ

(Lisbon Appellation of Origin Registration)

ພາກທີ V

(Part V)

ຖິ່ນກຳເນີດ

Geographical Indications

3. ການປ່ຽນແປງ

(Changes)

ພາກທີ V
(Part V)
ຖິ່ນກຳເນີດ
Geographical Indications

4. ການດັດແກ້
(Amendments)

ພາກທີ VI

(Part VI)

ພັນພືດໃໝ່

New Plant Varieties

1. ຄໍາຮ້ອງ

(Applications)

ພາກທີ VI

(Part VI)

ພັນພືດໃໝ່

New Plant Varieties

2. ຜົນການຈັດທະບຽນ

(Registration)

ພາກທີ VI

(Part VI)

ພັນພືດໃໝ່

New Plant Varieties

3. ການປ່ຽນແປງ

(Changes)

ພາກທີ VI

(Part VI)

ພັນພືດໃໝ່

New Plant Varieties

4. ການດັດແກ້

(Amendments)

ພາກທີ VII

(Part VII)

ລິຂະສິດ ແລະ ສິດກ່ຽວຂ້ອງກັບລິຂະສິດ

Copyrights and Related Rights

1. ການແຈ້ງຂໍ້ມູນ

(Notifications)

ພາກທີ VII

(Part VII)

ລິຂະສິດ ແລະ ສິດກ່ຽວຂ້ອງກັບລິຂະສິດ

Copyrights and Related Rights

2. ການປ່ຽນແປງ

(Changes)

ພາກທີ VIII

(Part VIII)

ການແກ້ໄຂຂໍ້ຂັດແຍ່ງທາງດ້ານບໍລິຫານກ່ຽວກັບການຈົດທະບຽນຊັບ
ສິນອຸດສາຫະກຳ ແລະ ພັນພືດໃໝ່

**Administrative Dispute Resolutions on the Registration of
Industrial Property and New Plant Varieties**

1. ຜົນການຄັດຄ້ານຄຳຮ້ອງ

(Result of Oppositions)

ພາກທີ VIII

(Part VIII)

**ການແກ້ໄຂຂໍ້ຂັດແຍ່ງທາງດ້ານບໍລິຫານກ່ຽວກັບການຈັດທະບຽນຊັບ
ສິນອຸດສາຫະກຳ ແລະ ພັນພືດໃໝ່**

**Administrative Dispute Resolutions on the Registration of
Industrial Property and New Plant Varieties**

2. ຜົນການແຈ້ງປະຕິເສດ

(Result of Refusals)

ພາກທີ VIII

(Part VIII)

**ການແກ້ໄຂຂໍ້ຂັດແຍ່ງທາງດ້ານບໍລິຫານກ່ຽວກັບການຈົດທະບຽນຊັບ
ສິນອຸດສາຫະກຳ ແລະ ພັນພືດໃໝ່**

**Administrative Dispute Resolutions on the Registration of
Industrial Property and New Plant Varieties**

**3. ຜົນການຍົກເລີກ ຫຼື ລົບລ້າງ ຂອງການຈົດທະບຽນ
(Result of Cancellation or Invalidation of Registration)**