



ສາທາລະນະລັດ ປະຊາທິປະໄຕ ປະຊາຊົນລາວ  
LAO PEOPLE'S DEMOCRATIC REPUBLIC

ກະຊວງ ອຸດສາຫະກຳ ແລະ ການຄ້າ  
ກົມຊັບສິນທາງປັນຍາ

MINISTRY OF INDUSTRY AND COMMERCE  
DEPARTMENT OF INTELLECTUAL PROPERTY

ຈົດໝາຍເຫດທາງລັດຖະການ  
ກ່ຽວກັບ ຊັບສິນທາງປັນຍາ  
ຢູ່ ສປປ ລາວ

OFFICIAL GAZETTE ON INTELLECTUAL PROPERTY  
IN LAO PDR

ສະບັບທີ (Vol.) 285

# ພາກທີ I

## (Part I)

### ສິດທິບັດ ແລະ ອະນຸສິດທິບັດ

### (Patent and Petty Patent)

## 1. ຄໍາຮ້ອງ

### (Applications)

#### ຄໍາອະທິບາຍກ່ຽວກັບລະຫັດຫຍໍ້

#### (Introduction of Codes)

- (21) ເລກທີ ຄໍາຮ້ອງ (Filing Number)
- (22) ວັນທີ ຍືນຄໍາຮ້ອງ (Filing Date)
- (30) ວັນທີ ບຸລິມະສິດ (Priority Date)
- (43) ວັນທີເຜີຍແຜ່ (Publication Date)
- (51) ໝວດ (International Patent Classification)
- (54) ຊື່ຂອງການປະດິດ (Title)
- (57) ບົດຄັດຫຍໍ້ (Abstract)
- (71) ຊື່ ແລະ ທີ່ຢູ່ ເຈົ້າຂອງສິດທິບັດ ແລະ ອະນຸສິດທິບັດ (Owner Name and Address)
- (72) ຊື່ຜູ້ປະດິດ (Inventor Name)
- (74) ຊື່ຕົວແທນ (Representative Name)
- (55) ຮູບພາບ (Pictures)

# ພາກທີ I (Part I)

## ສິດທິບັດ ແລະ ອະນຸສິດທິບັດ (Patent and Petty Patent)

### 2. ຜົນການອອກສິດທິບັດ ແລະ ອະນຸສິດທິບັດ (Grant of Patents and Petty Patents)

#### ຄໍາອະທິບາຍກ່ຽວກັບລະຫັດຫຍໍ້ (Introduction of Codes)

- (11) ເລກທີ (Grant Number)
- (21) ເລກທີ ຄໍາຮ້ອງ (Filing Number)
- (22) ວັນທີຍືນຄໍາຮ້ອງ (Filing Date)
- (30) ວັນທີ ບຸລິມະສິດ (Priority Date)
- (43) ວັນທີເຜີຍແຜ່ (Publication Date)
- (51) ໝວດ (International Patent Classification)
- (54) ຫົວຂໍ້ການປະດິດ (Title)
- (57) ບົດຄັດຫຍໍ້ (Abstract)
- (71) ຊື່ ແລະ ທີ່ຢູ່ ເຈົ້າຂອງສິດທິບັດ ແລະ ອະນຸສິດທິບັດ (Owner Name and Address)
- (72) ຊື່ຜູ້ປະດິດ (Inventor Name)
- (74) ຊື່ຕົວແທນ (Representative Name)
- (55) ຮູບພາບ (Pictures)

**ພາກທີ I**

**(Part I)**

**ສິດທິຂັດ ແລະ ອະນຸສິດທິຂັດ**

**(Patent and Petty Patent)**

**3. ການປ່ຽນແປງ**

**(Changes)**

**ພາກທີ I**

**(Part I)**

**ສິດທິຂັດ ແລະ ອະນຸສິດທິຂັດ**

**(Patent and Petty Patent)**

**4. ການດັດແກ້**

**(Amendments)**

**ພາກທີ II**  
**(Part II)**  
**ແບບອຸດສາຫະກຳ**  
**(Industrial Design)**

**1. ຄຳຮ້ອງ**  
**(Applications)**

**ຄຳອະທິບາຍກ່ຽວກັບລະຫັດຫຍໍ້**  
**(Introduction of Codes)**

- (21) ເລກທີ ຄຳຮ້ອງ (Filing Number)
- (22) ວັນທີ ຄຳຮ້ອງ (Filing Date)
- (30) ວັນທີ ບຸລິມາສິດ (Priority Date)
- (51) ໝວດ (Locarno Classification)
- (54) ຊື່ຂອງແບບອຸດສາຫະກຳ (Title)
- (71) ຊື່ ແລະ ທີ່ຢູ່ ຂອງເຈົ້າຂອງ (Owner Name and Address)
- (72) ຊື່ຜູ້ອອກແບບ (Designer Name)
- (74) ຊື່ຕົວແທນ (Representative Name)
- (55) ຮູບພາບ (Pictures)

## ພາກທີ II

### (Part II)

## ແບບອຸດສາຫະກຳ (Industrial Design)

### 2. ຜົນການຈົດທະບຽນ (Registration)

#### ຄຳອະທິບາຍກ່ຽວກັບລະຫັດຫຍໍ້ (Introduction of Codes)

- (11) ເລກທີ ຈົດທະບຽນ (Registration Number)
- (15) ວັນທີ ຈົດທະບຽນ (Registration Date)
- (21) ເລກທີ ຍືນຄຳຮ້ອງ (Filing Number)
- (22) ວັນທີ ຍືນຄຳຮ້ອງ (Filing Date)
- (30) ວັນທີ ບຸລິມາສິດ (Priority Date)
- (17) ວັນທີ ໝົດອາຍຸ (Expiration Date)
- (51) ໝວດ (Locarno Classification)
- (54) ຊື່ຂອງແບບອຸດສາຫະກຳ (Title)
- (71) ຊື່ ແລະ ທີ່ຢູ່ ຂອງເຈົ້າຂອງ (Owner Name and Address)
- (72) ຊື່ຜູ້ອອກແບບ (Designer Name)
- (74) ຊື່ຕົວແທນ (Representative Name)
- (55) ຮູບພາບ (Pictures)

- |      |  |      |            |
|------|--|------|------------|
| (11) | No. 656  | (21) | ID 656     |
| (15) | 02/01/2025   | (22) | 25/03/2024 |
| (28) |  | (17) | 25/03/2029 |
| (30) | 20233063342.7 27/09/2023 CN  | (51) | 12-11      |
| (54) | Electric Motorcycle  |      |            |
| (71) | TAILG SCIENCE AND TECHNOLOGY (DONGGUAN) CO.,LTD.<br>Building 1, No.92, Fenghuang Road, Dalingshan, Dalingshan Town, Dongguan City,<br>Guangdong Province, China. |      |            |
| (72) | Muchu Sun; Yao Chang and Anchen You.   |      |            |
| (74) | Ageless Lao Sole Co. Ltd.  |      |            |
| (55) |  |      |            |

FIG. 1



FIG. 2





FIG. 3



FIG. 4



FIG. 5



FIG. 6



FIG. 7



FIG. 8



Official Gazette of Industrial Property Vol. 285, 03/01/2025

- |      |  |      |            |
|------|--|------|------------|
| (11) | No. 657  | (21) | ID 657     |
| (15) | 02/01/2025   | (22) | 22/04/2024 |
| (28) |  | (17) | 22/04/2029 |
| (30) | 202330683161.5 20/10/2023 CN   | (51) | 12-08      |
| (54) | AUTOMOBILE   |      |            |
| (71) | HOZON NEW ENERGY AUTOMOBILE CO., LTD.<br>NO. 988, TONGREN ROAD, WUTONG STREET, TONGXIANG, JIAXING, ZHEJIANG<br>314500, CHINA |      |            |
| (72) | CHANG, Bing.   |      |            |
| (74) | Tilleke & Gibbins Lao Co., Ltd.  |      |            |
| (55) |  |      |            |



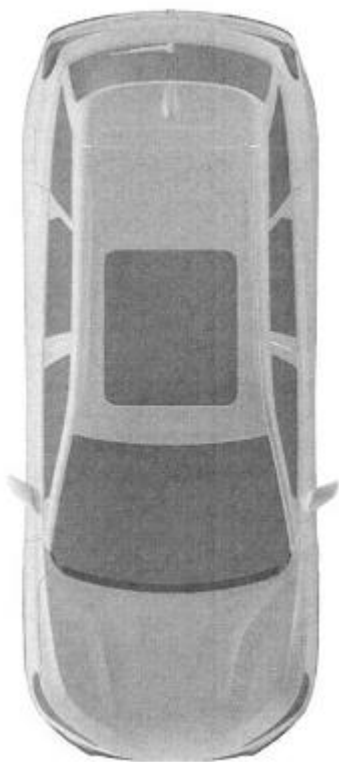
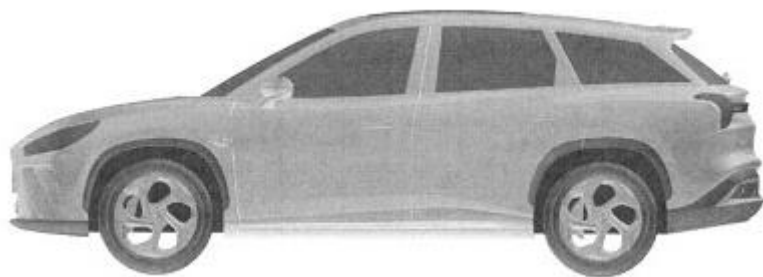

- |      |  |      |            |
|------|--|------|------------|
| (11) | No. 658  | (21) | ID 658     |
| (15) | 02/01/2025   | (22) | 08/05/2024 |
| (28) |  | (17) | 08/05/2029 |
| (30) | 202430150918.9 22/03/2024 CN   | (51) | 12-11      |
| (54) | Electric Motorcycle  |      |            |
| (71) | TAILG SCIENCE AND TECHNOLOGY (DONGGUAN) CO., LTD.<br>Building 1, No. 92, Fenghuang Road, Dalingshan, Dalingshan Town, Dongguan City,<br>Guangdong Province, China. |      |            |
| (72) | Muchu Sun.   |      |            |
| (74) | Ageless Lao Sole Co. Ltd.  |      |            |
| (55) |  |      |            |

**FIG. 1**



**FIG. 2**



**FIG. 3**



**FIG. 4**



**FIG. 5**



**FIG. 6**



**FIG. 7**



**FIG. 8**



Official Gazette of Industrial Property Vol. 285, 03/01/2025

- |      |  |      |            |
|------|--|------|------------|
| (11) | No. 659  | (21) | ID 659     |
| (15) | 02/01/2025   | (22) | 10/05/2024 |
| (28) |  | (17) | 10/05/2029 |
| (30) | 2023307434872 14/11/2023 CN  | (51) | 23-01      |
| (54) | Steel pipe pile lock (C type-I- shaped)  |      |            |
| (71) | Steel World (Hong Kong) Ltd<br>Flat D 28/F YHC Tower 1, Sheung Yuet Road, Kowloon Bay, Kowloon, Hong Kong,<br>China. |      |            |
| (72) | LIN, Qingbin.  |      |            |
| (74) | Concetti Lao Co., Ltd.   |      |            |
| (55) |  |      |            |





Official Gazette of Industrial Property Vol. 285, 03/01/2025

- |      |  |      |            |
|------|--|------|------------|
| (11) | No. 660  | (21) | ID 660     |
| (15) | 02/01/2025   | (22) | 08/07/2024 |
| (28) |  | (17) | 08/07/2029 |
| (30) |  | (51) | 09-03      |
| (54) | Long Neck Bottle Crate   |      |            |
| (71) | Platinum Pro Plastic Co., Ltd.<br>99/11 Moo 6, Makhamkoo, Nihomphattana, Rayong 21180, Thailand. |      |            |
| (72) | Mr. Chatarat Hiranchaowiwat.   |      |            |
| (74) | Tilleke & Gibbins Lao Co., Ltd.  |      |            |
| (55) |  |      |            |

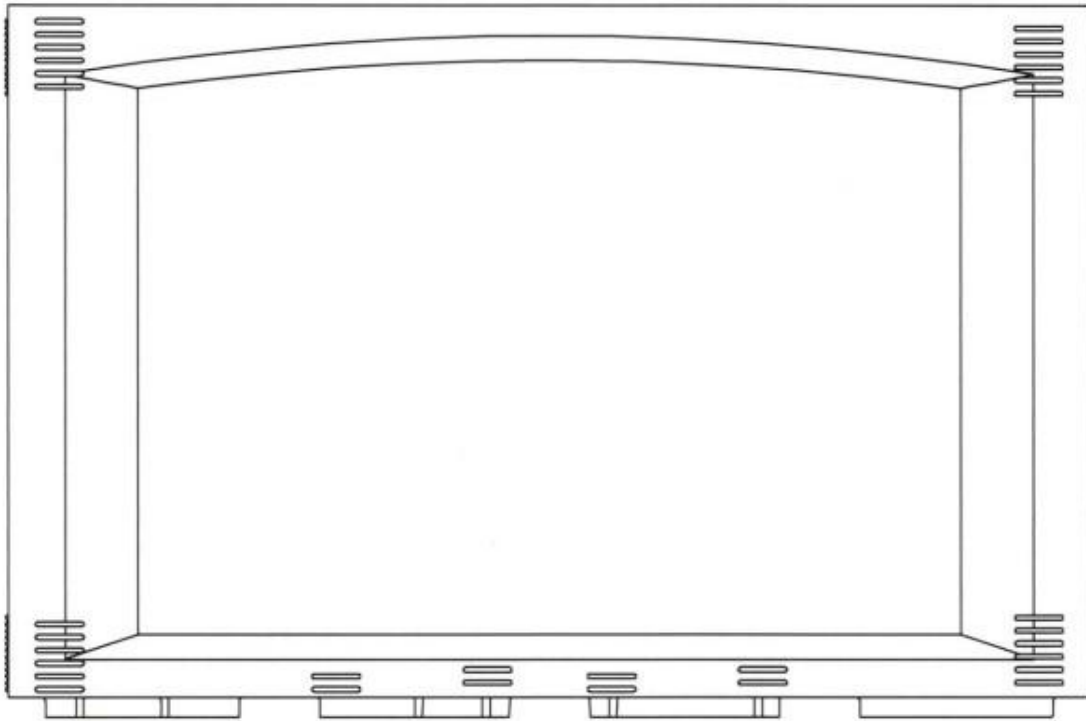

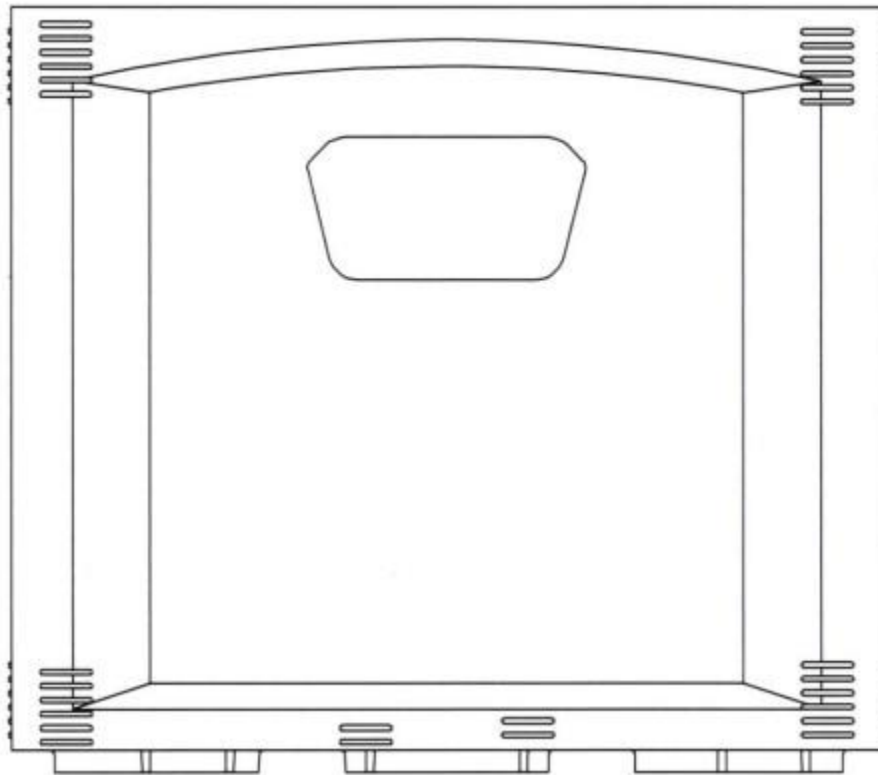
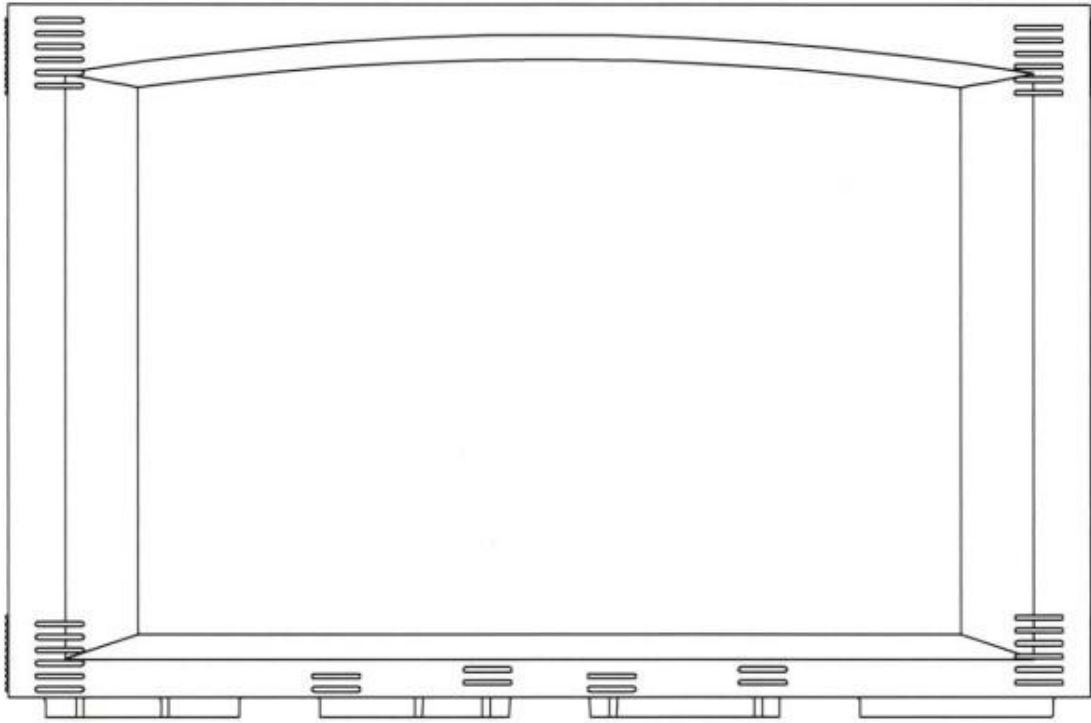

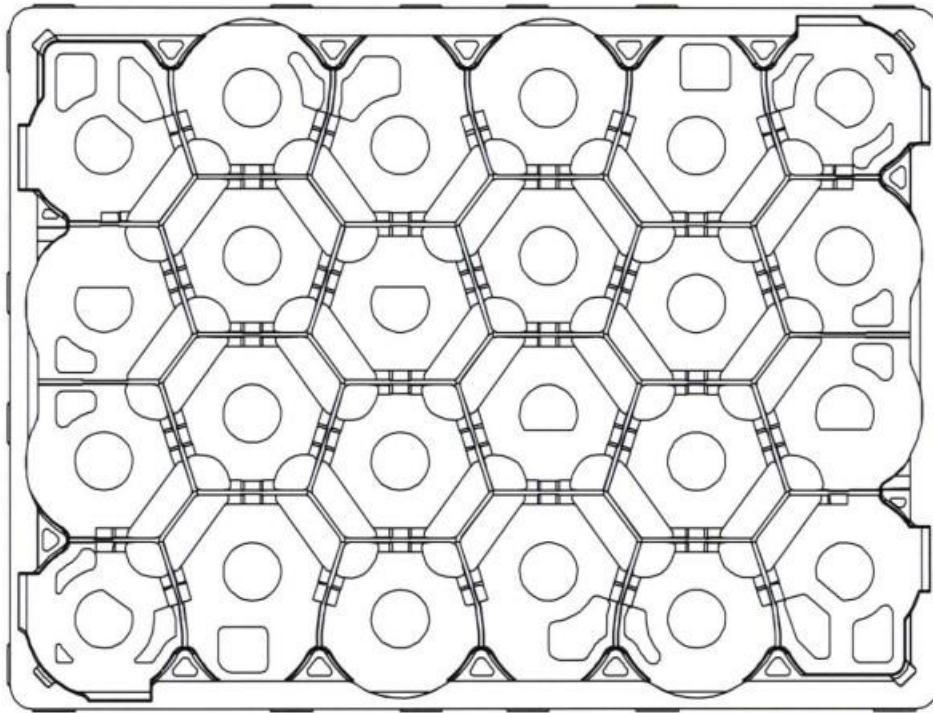
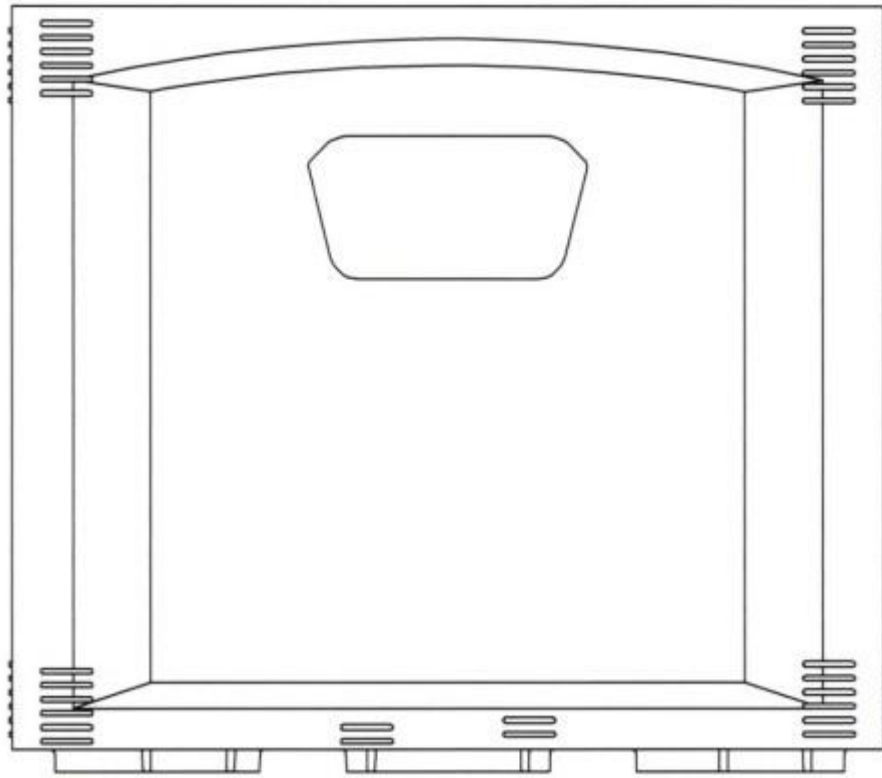

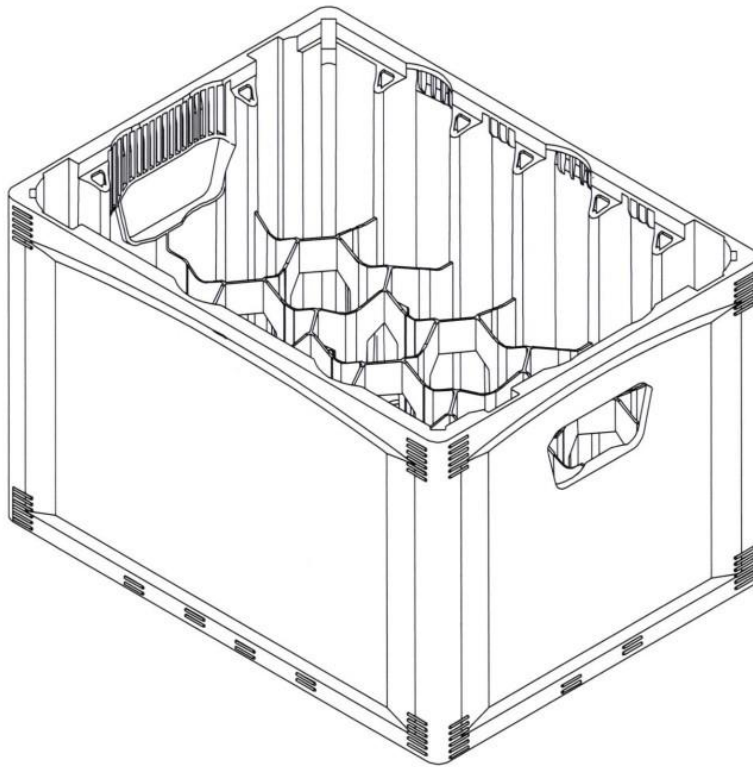
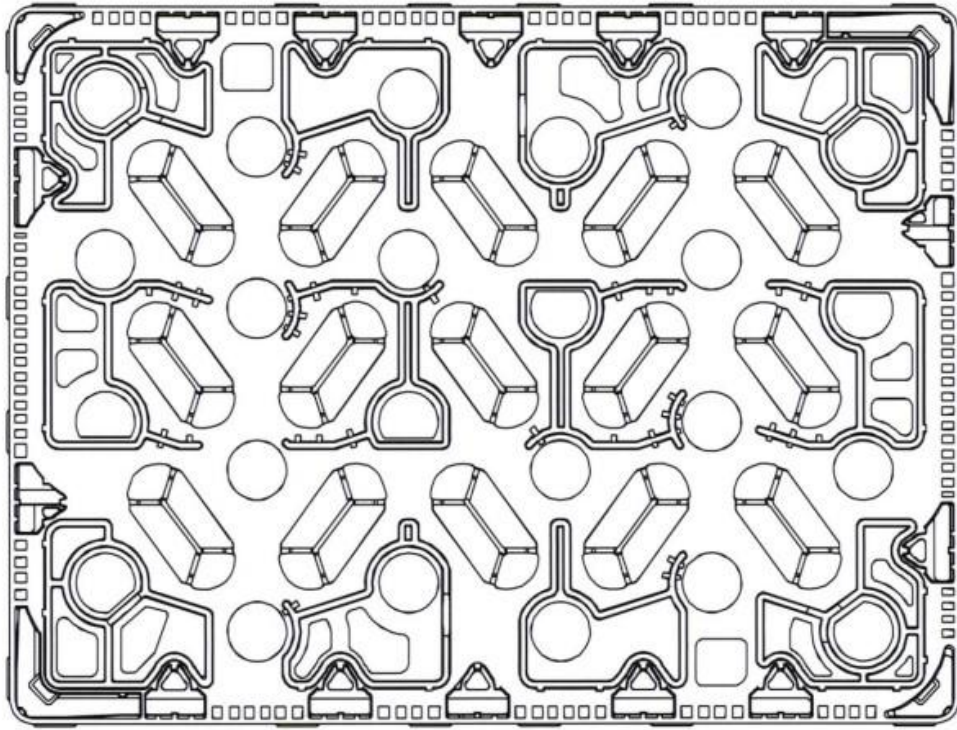

- |      |  |      |            |
|------|--|------|------------|
| (11) | No. 661  | (21) | ID 661     |
| (15) | 02/01/2025   | (22) | 08/07/2024 |
| (28) |  | (17) | 08/07/2029 |
| (30) |  | (51) | 09-03      |
| (54) | Short Neck Bottle Crate  |      |            |
| (71) | Platinum Pro Plastic Co., Ltd.<br>99/11 Moo 6, Makhamkoo, Nihomphattana, Rayong 21180, Thailand. |      |            |
| (72) | Mr. Chatarat Hiranchaowiwat.   |      |            |
| (74) | Tilleke & Gibbins Lao Co., Ltd.  |      |            |
| (55) |  |      |            |

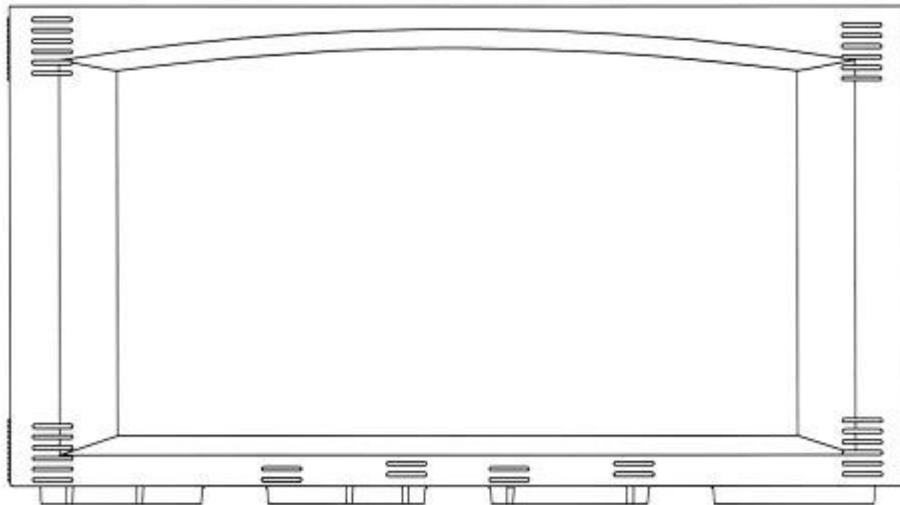
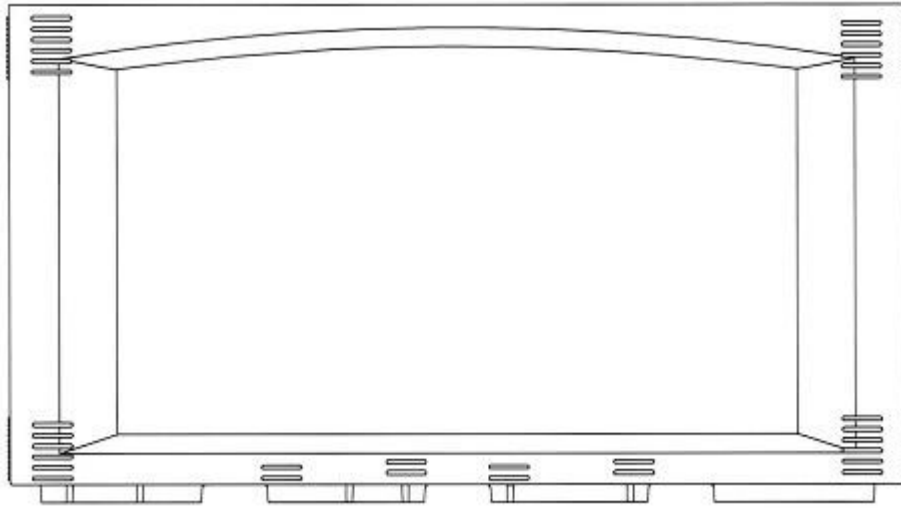

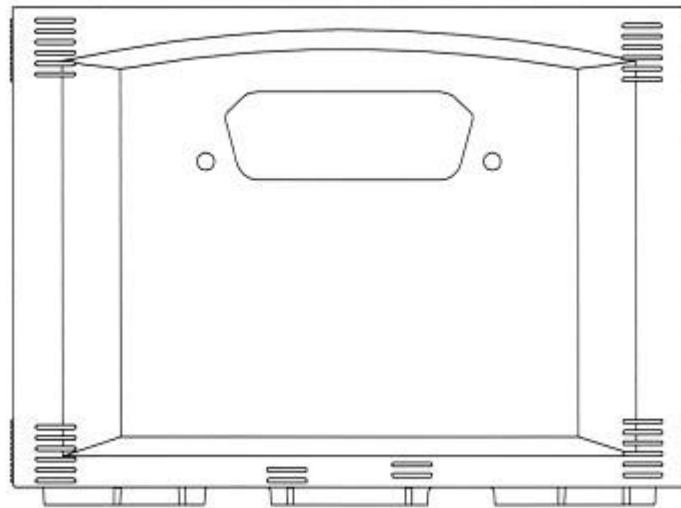
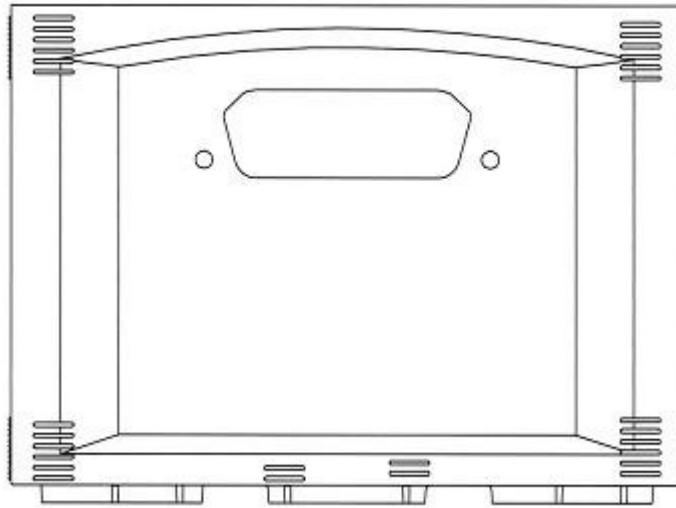

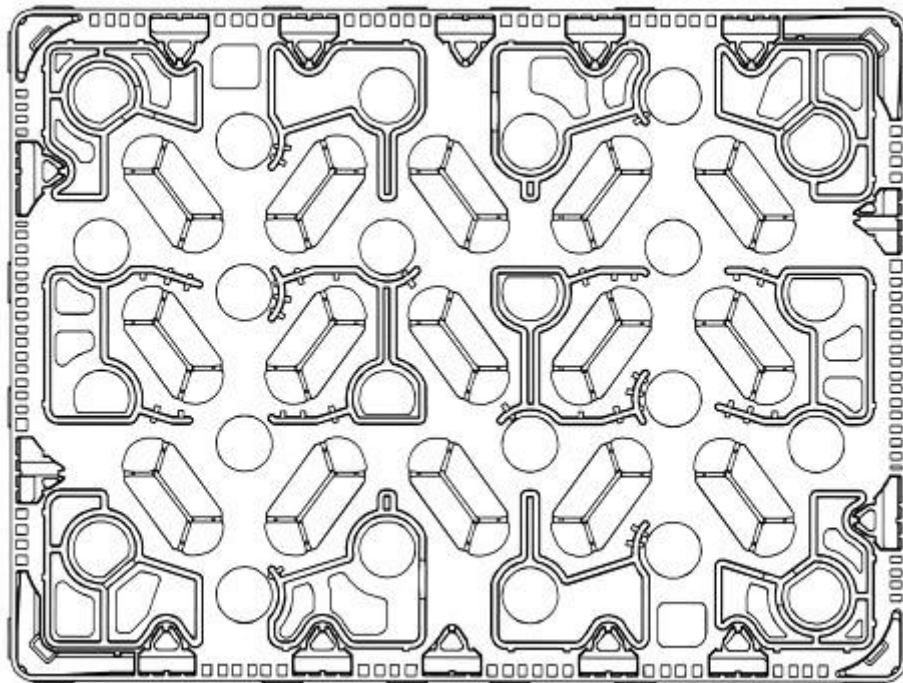
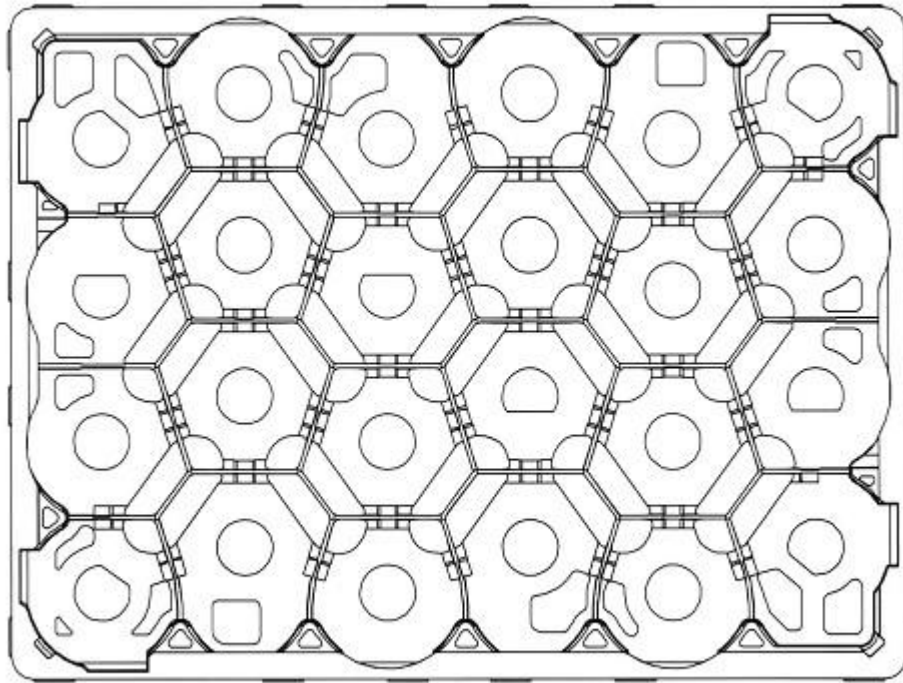

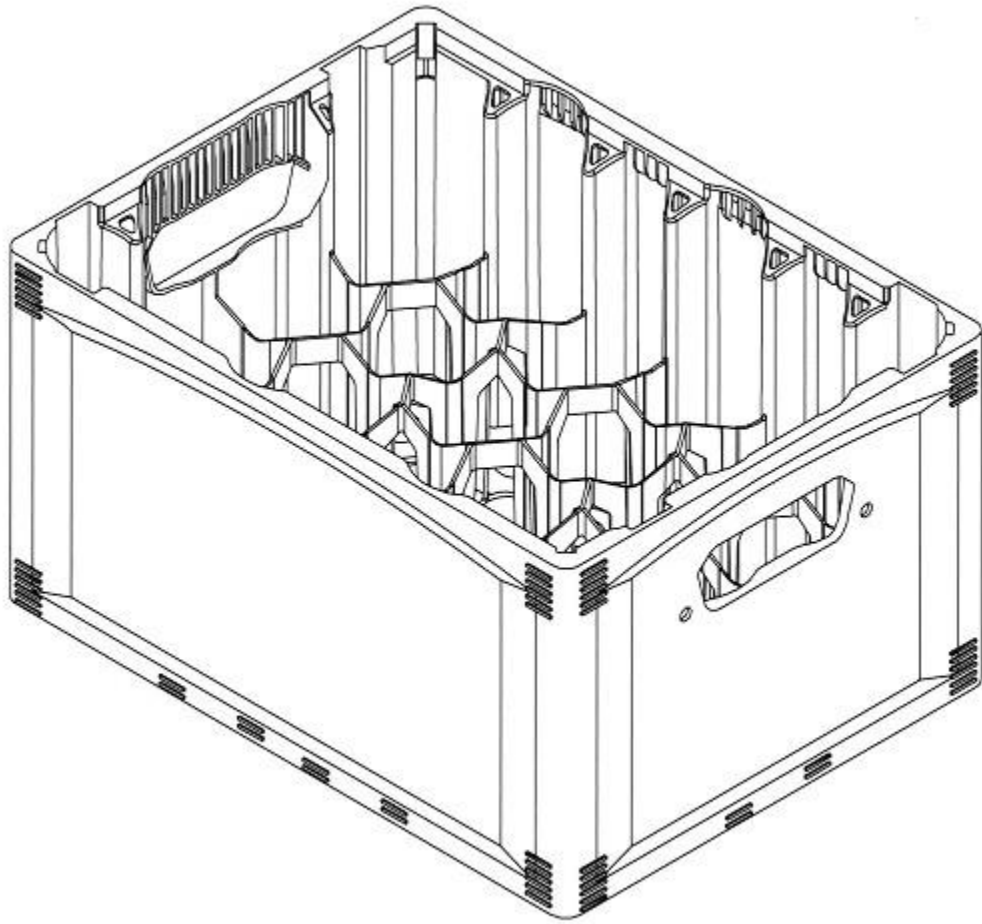



Official Gazette of Industrial Property Vol. 285, 03/01/2025

- |      |   |      |            |
|------|---|------|------------|
| (11) | No. 663   | (21) | ID 663     |
| (15) | 02/01/2025  | (22) | 24/07/2024 |
| (28) |   | (17) | 24/07/2029 |
| (30) | 2024-002583 07/02/2024 JP   | (51) | 12-11      |
| (54) | A motor scooter   |      |            |
| (71) | HONDA MOTOR CO., LTD.<br>1-1, Minami-Aoyama 2-Chome, Minato-ku, Tokyo, 107-8556, Japan. |      |            |
| (72) | PRATAMA Rosyid Abdur and SAKAMOTO Ken.  |      |            |
| (74) | Lao Trademark Agency (LAO IP AGENCY).   |      |            |
| (55) |   |      |            |



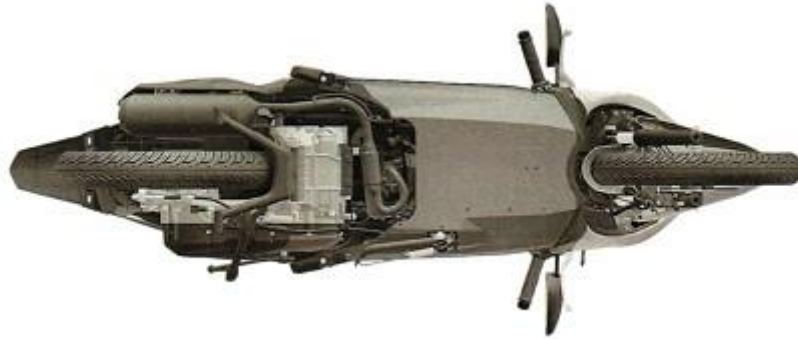





**ພາກທີ II**

**(Part II)**

**ແບບອຸດສາຫະກຳ  
(Industrial Design)**

**3. ການປ່ຽນແປງ**

**(Changes)**

**ພາກທີ II**

**(Part II)**

**ແບບອຸດສາຫະກຳ**

**(Industrial Design)**

**4. ການດັດແກ້**

**(Amendments)**

**ພາກທີ III**  
**(Part III)**  
**ເຄື່ອງໝາຍການຄ້າ**  
**Trademarks**

**1. ຄໍາຮ້ອງ**  
**(Applications)**

**ຄໍາອະທິບາຍກ່ຽວກັບລະຫັດຫຍໍ້**  
**(Introduction of Codes)**

- (540) ເຄື່ອງໝາຍການຄ້າ (Trademark)
- (511) ໝວດ (Nice Classification)
- (210) ເລກທີ ຄໍາຮ້ອງ (Number of the application)
- (220) ວັນທີ ຄໍາຮ້ອງ (Date of filing of the application)
- (732) ຊື່ ແລະ ທີ່ຢູ່ ຂອງຜູ້ຍື່ນຄໍາຮ້ອງ (Name and Address of applicant)

**ພາກທີ III**  
**(Part III)**  
**ເຄື່ອງໝາຍການຄ້າ**  
**Trademarks**

**2. ຜົນການຈົດທະບຽນ**  
**(Registration)**

**ຄຳອະທິບາຍກ່ຽວກັບລະຫັດຫຍໍ້**  
**(Introduction of Codes)**

- (540) ເຄື່ອງໝາຍການຄ້າ (Trademark)
- (511) ໝວດ (Nice Classification)
- (210) ເລກທີ ຄຳຮ້ອງ (Number of the application)
- (220) ວັນທີ ຄຳຮ້ອງ (Date of filing of the application)
- (732) ຊື່ ແລະ ທີ່ຢູ່ ຂອງຜູ້ຍື່ນຄຳຮ້ອງ (Name and Address of applicant)
- (111) ເລກທີ ການຈົດທະບຽນເຄື່ອງໝາຍການຄ້າ (Number of the registration)
- (180) ວັນໝົດອາຍຸຂອງການຈົດທະບຽນ (Expiration date of the registration)



**ພາກທີ III**  
**(Part III)**  
**ເຄື່ອງໝາຍການຄ້າ**  
**Trademarks**

**3. ການຕໍ່ອາຍ**  
**(Renewal)**

**ຄຳອະທິບາຍກ່ຽວກັບລະຫັດຫຍໍ້**  
**(Introduction of Codes)**

- (540) ເຄື່ອງໝາຍການຄ້າ (Trademark)
- (511) ໝວດ (Nice Classification)
- (210) ເລກທີ ຄຳຮ້ອງ (Number of the application)
- (220) ວັນທີ ຄຳຮ້ອງ (Date of filing of the application)
- (732) ຊື່ ແລະ ທີ່ຢູ່ ຂອງຜູ້ຍື່ນຄຳຮ້ອງ (Name and Address of applicant)
- (111) ເລກທີການຈັດທະບຽນເຄື່ອງໝາຍການຄ້າ (Number of the registration)
- (180) ການຕໍ່ອາຍການຈັດທະບຽນ (Expiration date of the renewal)

(540) Trademark Renewal

**NOKIA**

(511)

(210) No. 3056

(220) 06/06/1994

(732) Nokia Corporation

Karakaari 7, 02610 Espoo, Finland

(111) No. 2965

(180) 06/06/2034

(540) Trademark Renewal

**KHONG GUAN**

(511) 30

(210) No. 3425

(220) 21/11/1994

(732) KHOG GUAN OVERSEAS INVESTMENT  
LTD

Flat E, 2nd Floor, Block 2, Kwun Tong

Industrial Centre, 460-470 Kwun Tong Road,

Kwun Tong, Kowloon, Hong Kong

(111) No. 3460

(180) 21/11/2034

(540) Trademark Renewal

**GEOX**

(511) 18

(210) No. 11280

(220) 21/05/2004

(732) GEOX S.P.A

Via Feltrina Centro 16 Montebelluna Frazione  
Biadene (Treviso), Italy

(111) No. 10468

(180) 20/05/2034

(540) Trademark Renewal

**GEOX**

(511) 25

(210) No. 11284

(220) 21/05/2004

(732) GEOX S.P.A

Via Feltrina Centro 16 Montebelluna Frazione  
Biadene (Treviso), Italy

(111) No. 10772

(180) 20/05/2034

(540) Trademark Renewal



(511) 17

(210) No. 11693

(220) 26/08/2004

(732) PT Sumatra Tobacco Trading Company  
Jalan Pattimura No. 3, Pematang Siantar,  
Sumatera Utara, Indonesia

(111) No. 11127

(180) 01/09/2034

(540) Trademark Renewal



(511) 18

(210) No. 11694

(220) 26/08/2004

(732) PT Sumatra Tobacco Trading Company  
Jalan Pattimura No. 3, Pematang Siantar,  
Sumatera Utara, Indonesia

(111) No. 11128

(180) 01/09/2034

(540) Trademark Renewal



(511) 23

(210) No. 11699

(220) 26/08/2004

(732) PT Sumatra Tobacco Trading Company  
Jalan Pattimura No. 3, Pematang Siantar,  
Sumatera Utara, Indonesia

(111) No. 11133

(180) 01/09/2034

(540) Trademark Renewal



(511) 29

(210) No. 11705

(220) 26/08/2004

(732) PT Sumatra Tobacco Trading Company  
Jalan Pattimura No. 3, Pematang Siantar,  
Sumatera Utara, Indonesia

(111) No. 11139

(180) 01/09/2034

(540) Trademark Renewal

**HOM MALI**

(511) 30

(210) No. 12175

(220) 18/11/2004

(732) Department of Foreign Trade, Ministry of  
Commerce

563 Nonthaburi Road, Amphur Muang,  
Nonthaburi 11000, Thailand

(111) No. 11678

(180) 18/11/2034

(540) Trademark Renewal



(511) 29

(210) No. 28351

(220) 08/01/2013

(732) BEST BEAN INTERNATIONAL PTE LTD  
705 Sims Drive #04-16B, Shun Li Industrial  
Complex, Singapore 387384

(111) No. 28274

(180) 30/06/2034

(540) Trademark Renewal



(511) 43

(210) No. 28352

(220) 08/01/2013

(732) BEST BEAN INTERNATIONAL PTE LTD

705 Sims Drive #04-16B, Shun Li Industrial  
Complex, Singapore 387384

(111) No. 28275

(180) 30/06/2034

(540) Trademark Renewal

**SPG**

(511) 36

(210) No. 28783

(220) 12/03/2013

(732) PREFERRED GUEST, INC.

7750 Wisconsin Avenue, Bethesda, Maryland  
20814, United States of America

(111) No. 28616

(180) 29/08/2034

(540) Trademark Renewal

**ROSEMOUNT**

(511) 33

(210) No. 29113

(220) 19/04/2013

(732) TREASURY WINE ESTATES UK BRANDS  
LIMITED

Regal Houes, 70 London Road, Twickenham  
Middlesex TW1 3QS, United Kingdom

(111) No. 28921

(180) 04/09/2034

(540) Trademark Renewal

**LINDEMANS**

(511) 33

(210) No. 29114

(220) 19/04/2013

(732) TREASURY WINE ESTATES UK BRANDS  
LIMITED

Regal Houes, 70 London Road, Twickenham  
Middlesex TW1 3QS, United Kingdom

(111) No. 28922

(180) 04/09/2034



(540) Trademark Renewal

**PENFOLDS**

(511) 33

(210) No. 29115

(220) 19/04/2013

(732) Southcorp Brands Pty Limited

Level 8, 161 Collins street, Melbourne,  
Victoria 3000, Australia

(111) No. 28923

(180) 04/09/2034

(540) Trademark Renewal

**BERINGER**

(511) 33

(210) No. 29118

(220) 19/04/2013

(732) Treasury Wine Estates Americas Company

555 Gateway Drive, Napa, California 94558,  
United States of America

(111) No. 28926

(180) 04/09/2034

(540) Trademark Renewal

**WOLF BLASS**

(511) 33

(210) No. 29119

(220) 19/04/2013

(732) BILYARA VINEYARDS PTY LTD

Level 8, 161 Collins street, Melbourne,  
Victoria 3000, Australia

(111) No. 28927

(180) 04/09/2034

(540) Trademark Renewal



(511) 12

(210) No. 30191

(220) 29/08/2013

(732) SHAANXI HEAVY - DUTY

AUTOMOBILE CO., LTD

JINGWEI INDUSTRIAL PARK, XI'AN  
ECONOMIC AND TECHNOLOGICAL  
DEVELOPMENT ZONE, XI'AN 710200,  
SHAANXI, CHINA

(111) No. 29942

(180) 04/12/2034

(540) Trademark Renewal



(511) 35

(210) No. 30192

(220) 29/08/2013

(732) SHAANXI HEAVY - DUTY

AUTOMOBILE CO., LTD

JINGWEI INDUSTRIAL PARK, XI'AN

ECONOMIC AND TECHNOLOGICAL

DEVELOPMENT ZONE, XI'AN 710200,

SHAANXI, CHINA

(111) No. 29943

(180) 04/12/2034

(540) Trademark Renewal



(511) 04

(210) No. 30208

(220) 02/09/2013

(732) KUNMING YUNNEI POWER CO., LTD.

No. 66, Jingjing Road, Kunming Economic

Development Zone, Pilot Free Trade Zone,

Yunnan, China

(111) No. 29959

(180) 04/12/2034

(540) Trademark Renewal



(511) 07

(210) No. 30209

(220) 02/09/2013

(732) KUNMING YUNNEI POWER CO., LTD.

No. 66, Jingjing Road, Kunming Economic  
Development Zone, Pilot Free Trade Zone,  
Yunnan, China

(111) No. 29960

(180) 04/12/2034

(540) Trademark Renewal



(511) 12

(210) No. 30210

(220) 02/09/2013

(732) KUNMING YUNNEI POWER CO., LTD.

No. 66, Jingjing Road, Kunming Economic  
DevelopmentZone, Pilot Free Trade Zone,  
Yunnan, China

(111) No. 29961

(180) 04/12/2034

(540) Trademark Renewal

**IMBRUVICA**

(511) 05

(210) No. 30450

(220) 01/10/2013

(732) JOHNSON & JOHNSON

ONE JOHNSON & JOHNSON PLAZA,  
NEW BRUNSWICK, NEW JERSEY, 08933.,  
UNITED STATES OF AMERICA

(111) No. 30202

(180) 05/12/2034

(540) Trademark Renewal

**BAKOMA MIKUŚ**

(511) 29

(210) No. 30487

(220) 04/10/2013

(732) BAKOMA Sp. z o.o

Polczyńska 97A, 01-303 Warszawa, Poland

(111) No. 30228

(180) 05/12/2034

(540) Trademark Renewal

**BAKOMA BAKUŚ**

(511) 29

(210) No. 30488

(220) 04/10/2013

(732) BAKOMA Sp. z o.o

Polczyńska 97A, 01-303 Warszawa, Poland

(111) No. 30229

(180) 05/12/2034

(540) Trademark Renewal

**BAKOMA TWIST**

(511) 29

(210) No. 30489

(220) 04/10/2013

(732) BAKOMA Sp. z o.o

Polczyńska 97A, 01-303 Warszawa, Poland

(111) No. 30230

(180) 05/12/2034

(540) Trademark Renewal

**BAKOMA SATINO**

(511) 29

(210) No. 30490

(220) 04/10/2013

(732) BAKOMA Sp. z o.o

Polczyńska 97A, 01-303 Warszawa, Poland

(111) No. 30231

(180) 05/12/2034

(540) Trademark Renewal

**BAKOMA SONATA**

(511) 29

(210) No. 30491

(220) 04/10/2013

(732) BAKOMA Sp. z o.o

Polczyńska 97A, 01-303 Warszawa, Poland

(111) No. 30232

(180) 05/12/2034

(540) Trademark Renewal

**BAKOMA PREMIO**

(511) 29

(210) No. 30492

(220) 04/10/2013

(732) BAKOMA Sp. z o.o

Polczyńska 97A, 01-303 Warszawa, Poland

(111) No. 30233

(180) 05/12/2034

(540) Trademark Renewal



(511) 29

(210) No. 30493

(220) 04/10/2013

(732) BAKOMA Sp. z o.o

Polczyńska 97A, 01-303 Warszawa, Poland

(111) No. 30234

(180) 05/12/2034



(540) Trademark Renewal



(511) 29

(210) No. 30494

(220) 04/10/2013

(732) BAKOMA Sp. z o.o

Polczyńska 97A, 01-303 Warszawa, Poland

(111) No. 30235

(180) 05/12/2034

(540) Trademark Renewal



(511) 29

(210) No. 30495

(220) 04/10/2013

(732) BAKOMA Sp. z o.o

Polczyńska 97A, 01-303 Warszawa, Poland

(111) No. 30236

(180) 05/12/2034

(540) Trademark Renewal

**VIETCEREAL**

(511) 30

(210) No. 30586

(220) 21/10/2013

(732) THANH AN COMPANY LIMITED

3 rd Floor, Minh Tam Building, 137 Nguyen

Van Cu, Ngoc Lam War Long Bien District,

Hanoi City., Vietnam

(111) No. 30317

(180) 05/12/2034

**ພາກທີ III**  
**(Part III)**

**ເຄື່ອງໝາຍການຄ້າ**  
**Trademarks**

**4. ການປ່ຽນແປງ**  
**(Changes)**

**ພາກທີ III**

**(Part III)**

**ເຄື່ອງໝາຍການຄ້າ**

**Trademarks**

**5. ການດັດແກ້**

**(Amendments)**

## ພາກທີ IV

### (Part IV)

## ເຄື່ອງໝາຍການຄ້າຜ່ານລະບົບມາດຣິດ

### Trademarks via Madrid Protocol

#### 1. ຄໍາຮ້ອງ

#### (Applications)

##### ຄໍາອະທິບາຍກ່ຽວກັບລະຫັດຫຍໍ້

##### (Introduction of Codes)

- (540) ເຄື່ອງໝາຍການຄ້າ (Trademark)
- (511) ໝວດ (Nice Classification)
- (210) ເລກທີ ຄໍາຮ້ອງ (Number of the application)
- (220) ວັນທີ ຄໍາຮ້ອງ (Date of filing of the application)
- (732) ຊື່ ແລະ ທີ່ຢູ່ ຂອງຜູ້ຍື່ນຄໍາຮ້ອງ (Name and Address of applicant)

(540)Madrid Application

**STELLA**

(511) 32

(210) No. M/0755873

(220) 07/11/2024

(732) Anheuser-Busch InBev S.A.

Grand-Place 1 B-1000 Brussels, Belgium

(540)Madrid Application

**ENGEL**

(511) 09, 18 and 25

(210) No. M/1118157

(220) 10/12/2024

(732) F. Engel K/S

Norgesvej 12 DK-6100 Haderslev, Denmark

(540)Madrid Application

(511) 16, 36, 41, 42 and 44

(210) No. M/1120170

(220) 15/11/2024

(732) INSTITUT CURIE

26 rue d'Ulm F-75005 PARIS, France

(540)Madrid Application

(511) 01, 04, 06, 07, 09, 10, 11, 12, 17, 19 and 37

(210) No. M/1233236

(220) 04/12/2024

(732) Nabtesco Corporation

JA Kyosai Bldg., 7-9, Hirakawacho 2-chome,  
Chiyoda-ku Tokyo 102-0093, Japan

(540)Madrid Application

(511) 09

(210) No. M/1238261

(220) 20/11/2024

(732) Lihe Technology (Hunan) Co., Ltd.  
No. 668 Qingshan Road Information Park,  
High-tech District, Changsha City Hunan  
Province, China

(540)Madrid Application

(511) 09

(210) No. M/1441917

(220) 20/11/2024

(732) ETNIA EYEWEAR CULTURE, S.L.  
Enric Morera 42-44 E-08950 ESPLUGUES  
DE LLOBREGAT, Spain



(540)Madrid Application

(511) 29 and 32

(210) No. M/1632780

(220) 15/10/2024

(732) Sichuan Weiyi Beverage and Food Co., Ltd.  
2.5 kilometres to the Lanjian Avenue Shifang,  
Sichuan, China

(540)Madrid Application

(511) 01 and 05

(210) No. M/1646495

(220) 09/12/2024

(732) SUMITOMO CHEMICAL COMPANY,  
LIMITED

2-7-1, Nihonbashi, Chuo-ku Tokyo 103-6020,  
Japan

**SUMILARV**

(540)Madrid Application

(511) 14

(210) No. M/1703297

(220) 04/12/2024

(732) Citizen Tokei Kabushiki Kaisha also trading  
as Citizen Watch Co., Ltd.

1-12, 6-chome, Tanashi-cho, Nishi-tokyo-shi  
Tokyo 188-8511, Japan

(540)Madrid Application

(511) 09 and 42

(210) No. M/1760066

(220) 18/10/2024

(732) SAMSUNG ELECTRONICS CO., LTD.

129, Samsung-ro, Yeongtong-gu Suwon-si,  
Gyeonggi-do, Republic of Korea

(540)Madrid Application

(511) 11

(210) No. M/1785112

(220) 15/10/2024

(732) Yang Xiaoli

No. 37, Qiaobei 1st Road, Liusha Town,  
Puning City, Jieyang City Guangdong  
Province, China

(540)Madrid Application

(511) 43

(210) No. M/1804559

(220) 05/12/2024

(732) Radisson Hospitality Belgium B.V. / S.R.L.

Avenue du Bourget 44 B-1130 Brussel,  
Belgium

**PRIZE BY  
RADISSON**

(540)Madrid Application

(511) 35, 41 and 43

(210) No. M/1810401

(220) 14/11/2024

(732) BLUE ORIGIN MANAGEMENT

CONSULTANT PTE. LTD.

73 UPPER PAYA LEBAR ROAD, #07-02J

CENTRO BIANCO SINGAPORE 534818

(540)Madrid Application

(511) 12

(210) No. M/1823310

(220) 04/12/2024

(732) Mazda Motor Corporation

3-1, Shinchu, Fuchu-cho, Aki-gun Hiroshima

730-8670, Japan

(540)Madrid Application

(511) 17

(210) No. M/1826796

(220) 21/08/2024

(732) Jiangsu Xinchu New Materials Co., Ltd  
Group 13, Xuzhuang Village, Jiangduo  
Town, Jiangyan District, Taizhou City  
225500 Jiangsu Province, China

(540)Madrid Application

(511) 18

(210) No. M/1826797

(220) 14/10/2024

(732) Baoding Baigou New City Haoshuai Luggage  
Sales Department  
No. 164, 2nd Floor, Zone 6, Hedao  
International Luggage and Leather Trading  
Center, Baigou Town, Baoding City Hebei  
Province, China

(540)Madrid Application

(511) 35

(210) No. M/1826832

(220) 23/05/2024

(732) Geng Yanzhou

No. 40, Gengxi Team, Gengchong Village,  
Liufu Town, Fengyang County Anhui  
Province, China

(540)Madrid Application

(511) 22

(210) No. M/1826881

(220) 18/10/2024

(732) Haining Jinchao Industrial Co., Ltd.

No. 13, Jinchang Road, Haining Economic  
Development Zone, Haining City Zhejiang  
Province, China

(540)Madrid Application

(511) 09

(210) No. M/1826888

(220) 03/09/2024

(732) Shenzhen Liangdianpai Technology Co., Ltd.  
No. 201, No. 8, Gankengtong Fuyu Industrial  
Zone, Gankeng Community, Jihua Street,  
Longgang District, Shenzhen Guangdong,  
China

(540)Madrid Application

(511) 03

(210) No. M/1826889

(220) 13/09/2024

(732) Shanghai Huafeng Commodity Co.,Ltd.  
2-3F, No. 1, Lane 518, Zidong Road,  
Minhang District Shanghai City, China

(540)Madrid Application

(511) 28

(210) No. M/1826892

(220) 23/08/2024

(732) Ren Xiufang

Room 403, Unit 2, No. 29, Longyuewan  
Community, Huancui District, Weihai City  
264200 Shandong Province, China

(540)Madrid Application

(511) 09

(210) No. M/1826924

(220) 06/09/2024

(732) Greentest Technology Co., Ltd.

Room 201, Building A, No.1 Qianwan 1st  
Road, Qianhai Shenzhen Hong Kong  
Cooperation Zone, Shenzhen 518000  
Guangdong, China



(540)Madrid Application

**HUADEHOME**

(511) 21

(210) No. M/1826934

(220) 01/11/2024

(732) Chaozhou Huade Ceramics Manufacture  
Co.,Ltd

Plant A18, North of Zhengong West Road,  
Phase II Industrial Park, Chaozhou 521000  
Guangdong Province, China

(540)Madrid Application

(511) 12

(210) No. M/1826950

(220) 04/11/2024

(732) Shandong Huasheng Rubber Co., Ltd.

Daozhuang Town Government Station,  
Guangrao County, Dongying City 257336  
Shandong Province, China

(540)Madrid Application

(511) 29

(210) No. M/1826953

(220) 04/11/2024

(732) Cofco Agri-Industries Management Co., Ltd.

Room 1223, Tower A, Cofco Plaza No. 8,

Jianguomennei Ave., Dongcheng District

Beijing, China

(540)Madrid Application

(511) 12

(210) No. M/1826956

(220) 11/09/2024

(732) Chery Automobile Co., Ltd.

No.8 Changchun Road, Economy &

Technology Development Zone, Wuhu City

241009 Anhui Province, China

(540)Madrid Application

(511) 03

(210) No. M/1826961

(220) 04/09/2024

(732) Shantou Minghui Biotechnology Co., Ltd.

3F, No. 7 Fenggao Rd Section, Zizhong Rd,  
Heping Town, Chaoyang Dist., Shantou City  
Guangdong Province, China

(540)Madrid Application

(511) 09

(210) No. M/1826965

(220) 11/09/2024

(732) Guiyang Zhong'an Technology Group Co.,  
Ltd.

No. 77, Shugu Avenue, Modern  
Manufacturing Industrial Park, Jinhua Town,  
Guanshanhu District, Guiyang City Guizhou  
Province, China

(540)Madrid Application

**MEGA MANIA  
SUPER SPIN**

(511) 41

(210) No. M/1826985

(220) 12/11/2024

(732) Interblock d.o.o.

6900 S Decatur Blvd, Suite 100 Las Vegas NV  
89118, United States of America

(540)Madrid Application

(511) 18

(210) No. M/1827037

(220) 11/10/2024

(732) Fujian OMI Investment Co., Ltd.

Unit D, Room 1501, Tongchuang Building,  
No. 2561, Binhai West Avenue, Science and  
Technology Innovation Park, Torch High-  
tech Zone, Xiamen Fujian, China

(540)Madrid Application

(511) 09 and 35

(210) No. M/1827040

(220) 04/09/2024

(732) Hubei Xingji Meizu Group Co., Ltd

No. B1345 Chuanggu Start-Up Area, Taizi  
Lake Cultural And Digital Creative Industry  
Park, No. 18, Shenlong Avenue, Wuhan  
Economic And Technological Development  
Zone, Wuhan Hubei, China

(540)Madrid Application

(511) 25

(210) No. M/1827043

(220) 11/09/2024

(732) JINJIANG WENYI IMPORT&EXPORT

TRADING CO.,LTD

Room 304, Building 3, Shimao Yulong Bay,  
Artificial Lake Area, Meiling Street, Jinjiang  
City, Quanzhou City 362000 Fujian Province,  
China

(540)Madrid Application

(511) 30

(210) No. M/1827045

(220) 21/10/2024

(732) Taohuayuan(Wuyishan) Agricultural  
Technology Co.,Ltd  
Floor 2, Building 2, No.69, Duba, Wuyijiaoting  
Village, Wuyishan 354300 Fujian, China

(540)Madrid Application

(511) 29, 30 and 32

(210) No. M/1827063

(220) 04/09/2024

(732) Dali Foods Group Limited  
Linkou, Zishan Town, Hui'An County  
Quanzhou 362100 Fujian, China

(540)Madrid Application

(511) 14

(210) No. M/1827065

(220) 24/09/2024

(732) Shenzhen STARKING Watch Co., Ltd.  
13th Floor, Building 1, STARKING Science  
and Technology Park, South side of  
Chuangye Road, East of No. 7 Road, No. 7  
Industrial Zone, Heshuikou Community,  
Gongming Street, Guangming New District,  
Shenzhen Guangdong, China

(540)Madrid Application

(511) 07 and 08

(210) No. M/1827067

(220) 19/09/2024

(732) NINGBO SHIJIBOSI TOOLS CO., LTD.  
No. 28, Beixing East Road, Mazhu Town,  
Yuyao, Ningbo 315000 Zhejiang, China

(540)Madrid Application

(511) 21

(210) No. M/1827068

(220) 04/11/2024

(732) Yiwu Ackiliss Electric Co., Ltd.

Room 2407-1, Block A, Futian Ginza, No.  
99, Financial 6 Street, Financial Business  
District, Futian Street, Yiwu City, Jinhua  
Zhejiang, China

(540)Madrid Application

(511) 09

(210) No. M/1827078

(220) 29/09/2024

(732) AUTOPHIX TECH CO., LTD

**AUTOPHIX**

Room 406, 403 and 402, Building 2, No. 8  
Xiangrong Road, Bujiuwo, Longping  
Community, Dalang Sub-district, Longhua  
District, Shenzhen 518000 Guangdong, China



(540)Madrid Application

(511) 03 and 04

(210) No. M/1827089

(220) 28/06/2024

(732) Dongguan Blue Origin Brand Management  
Co., Ltd.

Room 1501, Yujing Building, No. 577  
Dongcheng Road, Dongcheng District,  
Dongguan Guangdong Province, China

(540)Madrid Application

(511) 03 and 04

(210) No. M/1827090

(220) 28/06/2024

(732) Dongguan Blue Origin Brand Management  
Co., Ltd.

Room 1501, Yujing Building, No. 577  
Dongcheng Road, Dongcheng District,  
Dongguan Guangdong Province, China

(540)Madrid Application

(511) 12

(210) No. M/1827137

(220) 01/11/2024

(732) ZHEJIANG GEELY HOLDING GROUP  
CO., LTD.

1760 Jiangling Road, Binjiang District,  
Hangzhou Zhejiang, China

(540)Madrid Application

(511) 09

(210) No. M/1827142

(220) 09/09/2024

(732) GUANGDONG PISEN ELECTRONICS  
CO.,LTD

(Building 1-5) 1st Floor, No. 5 Factory  
Building, No. 9 Qinfu 1St Street, Liuyuanan  
Community, Henggang Street, Longgang  
District, Shenzhen City 518000 Guangdong  
Province, China

(540)Madrid Application

**PISEN CUBE**

(511) 09

(210) No. M/1827148

(220) 09/09/2024

(732) GUANGDONG PISEN ELECTRONICS  
CO.,LTD

(Building 1-5) 1st Floor, No. 5 Factory  
Building, No. 9 Qinfu 1St Street, Liuyuenan  
Community, Henggang Street, Longgang  
District, Shenzhen City 518000 Guangdong  
Province, China

(540)Madrid Application

**PHUCAL**

(511) 10

(210) No. M/1827155

(220) 25/09/2024

(732) Fei Yang

Room 206, Unit 3, Building 23, Heqiao  
Residential Area, Heqiao Village, Tangqiao  
Town, Zhangjiagang City 215600 Jiangsu  
Province, China

(540)Madrid Application



(511) 36

(210) No. M/1827235

(220) 11/09/2024

(732) XELTOX ENTERPRISES LTD

422 RICHARDS STREET, UNIT 170

VANCOUVER BC V6B 2Z4, CANADA

(540)Madrid Application

**CLUB MED**

(511) 39, 41, 43 and 44

(210) No. M/1827304

(220) 07/06/2024

(732) CLUB MED

11 Rue de Cambrai F-75019 PARIS, France

(540)Madrid Application



(511) 18 and 25

(210) No. M/1827376

(220) 24/09/2024

(732) INDUSTRIA DE DISEÑO TEXTIL, S.A.  
(INDITEX, S.A.)

Avenida de la Diputación, "Edificio Inditex"  
E-15142 Arteixo (A Coruña), Spain

(540)Madrid Application



(511) 33

(210) No. M/1827467

(220) 17/10/2024

(732) LOTTE CHILSUNG BEVERAGE CO.,  
LTD.

15, SEOCHO-DAERO 70-GIL, SEOCHO-  
GU SEOUL, REPUBLIC OF KOREA

(540)Madrid Application



(511) 12

(210) No. M/1827471

(220) 03/09/2024

(732) Profender Company Limited

8/8 Moo 3, Homkret Sub-district 73110

Sampran District, Nakhon Pathom, Thailand

(540)Madrid Application



(511) 09

(210) No. M/1827497

(220) 30/09/2024

(732) Potel Cable Group CO.,LTD

No.8899 Changdong Avenue, Hi-tech

Development Zone, Nanchang City 330000

Jiangxi Province, China

(540)Madrid Application

**Burning Coins**

(511) 09, 28 and 41

(210) No. M/1827516

(220) 24/07/2024

(732) Euro Games Technology Ltd.

Panorama Sofia Str. 6, Richhill Business  
Center, ground floor BG-1766 Vitosha Region,  
Sofia, Bulgaria

(540)Madrid Application

**eiléno**

(511) 06, 14, 16, 20, 21, 26 and 31

(210) No. M/1827575

(220) 13/08/2024

(732) Dongguan Blue Origin Brand Management  
Co., Ltd.

Room 1501, Yujing Building, No. 577  
Dongcheng Road, Dongcheng District,  
Dongguan Guangdong Province, China

(540)Madrid Application

蜜思琳

(511) 03, 05, 10, 30 and 32

(210) No. M/1827600

(220) 05/11/2024

(732) Zhejiang Tianxian Biopharmaceutical  
Co.,Ltd.

No.19,Fengxi West Road, Modern Industrial  
Cluster Zone, Fuying Street, Xianju County  
Taizhou City, Zhejiang Province, China

(540)Madrid Application

**TaiRay**

(511) 09

(210) No. M/1827606

(220) 21/10/2024

(732) LONGi Green Energy Technology Co., Ltd.

No. 388 Middle Hangtian Road, Chang'an  
District, Xi'an 710000 Shaanxi, China



(540)Madrid Application

**SIMO**

(511) 09, 12 and 42

(210) No. M/1827611

(220) 19/11/2024

(732) SHANGHAI JIDU AUTOMOBILE CO., LTD.

Building 2, No. 1688 Yecheng Road, Jiading  
District Shanghai, China

(540)Madrid Application

**SAG INTL**

(511) 12

(210) No. M/1827652

(220) 20/09/2024

(732) SHAANXI AUTOMOBILE GROUP CO.,  
LTD.

Jingwei Industrial Park, Xi'An Economic and  
Technological Development Zone, Xi'An  
710200 Shaanxi, China

(540)Madrid Application



(511) 01

(210) No. M/1827653

(220) 23/09/2024

(732) Guangzhou Kaimirui Fertilizer Co., Ltd.

No. 999, Wenfa Road, Dawen Industrial  
Zone, Dongyong Town, Nansha Free Trade  
Zone, Guangzhou City 510000 Guangdong  
Province, China

(540)Madrid Application



(511) 25

(210) No. M/1827658

(220) 30/09/2024

(732) Hangzhou Xingyi Technology Co., Ltd.

Room 1301-5, Yinfeng Building, No. 1505  
Binsheng Road, Xixing Street, Binjiang  
District, Hangzhou City Zhejiang Province,  
China

(540)Madrid Application

The logo consists of the letters 'LUSQI' in a bold, black, sans-serif font. The letter 'S' is stylized with a curved underline that extends to the right, passing under the 'Q' and 'I'.

(511) 07

(210) No. M/1827659

(220) 30/09/2024

(732) Zhejiang Lusiqi Import and Export Co., Ltd.  
No. 629, Maolin, Hongguang Village, Lunan  
Street, Luqiao District, Taizhou City 318050  
Zhejiang Province, China

(540)Madrid Application

The logo features the Chinese characters '奥陆' (Ào lù) in a bold, black, sans-serif font. Below the characters, the letters 'AUOLLU' are written in a bold, black, sans-serif font.

(511) 03

(210) No. M/1827747

(220) 29/07/2024

(732) Tianjin Feixuan Technology Co.,Ltd.  
Jiangjia Hutong Village Section, Baijian  
Township, Jingha Road North, Baijian Town,  
Jizhou District Tianjin, China

(540)Madrid Application



(511) 29 and 30

(210) No. M/1827801

(220) 24/09/2024

(732) RED LOONG GLOBAL HOLDINGS

PRIVATE LIMITED

346C KING GEORGE'S AVENUE, KING

GEORGE'S BUILDING SINGAPORE

208577

(540)Madrid Application



(511) 35 and 41

(210) No. M/1827808

(220) 22/10/2024

(732) Isha Foundation Inc.

951 Isha Lane McMinnville TN 37110,

United States of America

(540)Madrid Application



(511) 05

(210) No. M/1827894

(220) 11/10/2024

(732) Zhejiang Lamking Bio-Technology Co.,Ltd  
No. 2, Yanhu Road, Shangxi Town, Yiwu,  
Jinhua Zhejiang, China

(540)Madrid Application

**LONGi TaiRay**

(511) 09

(210) No. M/1827906

(220) 21/10/2024

(732) LONGi Green Energy Technology Co., Ltd.  
No. 388 Middle Hangtian Road, Chang'an  
District, Xi'an 710000 Shaanxi, China

(540)Madrid Application

**JAPAPROS**

(511) 05

(210) No. M/1827909

(220) 13/11/2024

(732) ASKA Pharmaceutical Co., Ltd.

5-1, Shibaura 2-chome, Minato-ku Tokyo 108-8532, Japan

(540)Madrid Application

**JUDOBY**

(511) 25 and 35

(210) No. M/1827931

(220) 30/08/2024

(732) DOKMA TEXTILE COMPANY LIMITED

No. 5 Lang Yen Street, Thanh Luong Ward,  
Hai Ba Trung District Hanoi City, Vietnam

(540)Madrid Application



(511) 12 and 35

(210) No. M/1827945

(220) 29/09/2024

(732) BEIQI FOTON MOTOR CO., LTD.

Laoniawan Village North, Shayang Road,  
Shahe Town, Changping District 102206  
Beijing, China

(540)Madrid Application

(511) 03, 06, 08, 10, 16, 18, 20, 21, 22, 25, 27 and  
28

(210) No. M/1827974

(220) 27/06/2024

(732) Shenzhen Blue Origin Brand Management  
Co., Ltd.

Room 3302, Building 2, Shenzhen New  
Generation Industrial Park, No. 136,  
Zhongkang Road, Meidu Community, Meilin  
Street, Futian District, Shenzhen City  
Guangdong Province, China

(540)Madrid Application



(511) 05

(210) No. M/1827977

(220) 21/10/2024

(732) Merck Sharp & Dohme B.V.

Waarderweg 39 NL-2031 BN Haarlem,  
The Netherlands

(540)Madrid Application



(511) 06, 07 and 09

(210) No. M/1827986

(220) 26/09/2024

(732) NINGBO UNITED TOOLS CO., LTD.

Room 501, No.1, Lishi Financial Plaza,  
Shouan Street, Yinzhou District, Ningbo  
City Zhejiang Province, China



(540)Madrid Application

**INFOWEAR**

(511) 09 and 14

(210) No. M/1827991

(220) 30/09/2024

(732) Chongqing Zhouhai Intelligent Technology  
Co., Ltd.

4th Floor, Building 9, Linkong Intelligent  
Industrial Park, No. 6 Langyue Road,  
Shuangfengqiao Street 401120 Yubei District,  
Chongqing City, China

(540)Madrid Application

**FASTRACK**

(511) 09 and 14

(210) No. M/1828056

(220) 17/05/2024

(732) TITAN COMPANY LIMITED

INTEGRITY, NO. 193, VEERASANDRA,  
ELECTRONICS CITY P. O., OFF HOSUR  
MAIN ROAD, BANGALORE 560100  
KARNATAKA, INDIA

(540)Madrid Application



(511) 25, 32, 33, 41 and 43

(210) No. M/1828072

(220) 04/06/2024

(732) Anheuser-Busch InBev S.A.

Grand-Place 1 B-1000 Brussels, Belgium

(540)Madrid Application

The logo for "5 CLOVER HIT" is centered on the left side of the second box. The text "5 CLOVER HIT" is written in a bold, stylized font. The numbers "5" and "HIT" are in yellow with a black outline, while "CLOVER" is in orange with a black outline. The letters have a slight 3D effect.

(511) 09, 28 and 41

(210) No. M/1828162

(220) 19/07/2024

(732) EGT DIGITAL LTD.

"Panorama Sofia" Str. 6, Business Center

"Richhill", block A BG-1766 Sofia, Bulgaria

(540)Madrid Application

**LUMIRA**

(511) 05 and 10

(210) No. M/1828171

(220) 11/11/2024

(732) Roche Diagnostics GmbH

Sandhofer Strasse 116 68305 Mannheim,  
Germany

(540)Madrid Application



(511) 12

(210) No. M/1828256

(220) 20/09/2024

(732) SHAANXI AUTOMOBILE GROUP CO.,  
LTD.

Jingwei Industrial Park, Xi'An Economic and  
Technological Development Zone, Xi'An  
710200 Shaanxi, China

(540)Madrid Application



(511) 09

(210) No. M/1828257

(220) 26/09/2024

(732) NUUKO POWER CO.,LTD

BUILDING 16, INTERSECTION OF

LINQUAN EAST ROAD AND

XIANGCHENG ROAD, FEIDONG

ECONOMIC DEVELOPMENT ZONE,

FEIDONG COUNTY, HEFEI CITY 230000

ANHUI PROVINCE, CHINA

(540)Madrid Application



(511) 12

(210) No. M/1828268

(220) 20/09/2024

(732) SHAANXI AUTOMOBILE GROUP CO.,  
LTD.

Jingwei Industrial Park, Xi'An Economic and

Technological Development Zone, Xi'An

710200 Shaanxi, China

(540)Madrid Application



(511) 04

(210) No. M/1828302

(220) 12/06/2024

(732) EASTMAN AUTO & POWER LTD

572, Udyog Vihar, Phase, V, Gurugram

Haryana 122016, India

(540)Madrid Application

**C'UVE DI PRUN**

(511) 33 and 43

(210) No. M/1828332

(220) 30/08/2024

(732) CROCE DEL VENTO S.R.L.

Via del Pontarol, 13, Marano di Valpolicella I-

37020 VERONA (VR), Italy

(540)Madrid Application



(511) 43

(210) No. M/1828345

(220) 24/10/2024

(732) BLACKSPOON INVESTMENT FZE

FZH 330 SRT, Floor Number 04, Sheikh  
Rashid Tower, Dubi World Trade Center  
Dubai, United Arab Emirates

(540)Madrid Application

**QIANWHITE**

(511) 03

(210) No. M/1828349

(220) 05/09/2024

(732) Qianxiaobai (Guangzhou) Pharmaceutical

Technology Co., Ltd.  
Room 301, No. 563, Yuncheng East Road,  
Baiyun District, Guangzhou City 510000  
Guangdong Province, China

(540)Madrid Application

**KOLAV**

(511) 09

(210) No. M/1828356

(220) 24/09/2024

(732) HONG Liang

Room 2005, Unit 1, Lihumingyuan,  
Huangsha Avenue, Liwan District  
Guangzhou, Guangdong, China

(540)Madrid Application

**SAGMOTO**

(511) 12

(210) No. M/1828362

(220) 20/09/2024

(732) SHAANXI AUTOMOBILE GROUP CO.,  
LTD.

Jingwei Industrial Park, Xi'An Economic and  
Technological Development Zone, Xi'An  
710200 Shaanxi, China

(540)Madrid Application



(511) 12

(210) No. M/1828444

(220) 23/07/2024

(732) Obshchestvo s ogranichennoy

otvetstvennost'yu "SK KANT"

Elektrolitnyy pr-d, d. 7, korp. 2 RU-115230

Moskva, Russian Federation

(540)Madrid Application

**Samsung Friends**

(511) 07, 09 and 11

(210) No. M/1828518

(220) 30/07/2024

(732) SAMSUNG ELECTRONICS CO., LTD.

129, Samsung-ro, Yeongtong-gu Suwon-si,

Gyeonggi-do, Republic of Korea



(540)Madrid Application

**SAKAI LEGEND**

(511) 31

(210) No. M/1828552

(220) 25/09/2024

(732) Solis High-Tech Ind.(Shenzhen)LTD.

NO. 33, Wanfeng Rd., Dafeng Vil., Dakang,  
Yuan Shan Sub-District, Longgang Dist.,  
Shenzhen Guangdong Province, China

(540)Madrid Application

**HELLO  
COCO**

(511) 32

(210) No. M/1828553

(220) 25/09/2024

(732) Hainan Xunxiang Food Co., Ltd

Room 766, 7/F, CMEC Building, Guomao  
Avenue, Longhua District, Haikou Hainan,  
China

(540)Madrid Application

**DALEAD**

(511) 29, 30 and 32

(210) No. M/1828594

(220) 01/11/2024

(732) DALI FOODS GROUP LIMITED

Linkou, Zishan Town, Hui'An County,  
Quanzhou 362100 Fujian, China

(540)Madrid Application

**GEMSY**

(511) 07

(210) No. M/1828710

(220) 05/07/2024

(732) Shang Gong Sewing Machine (Zhejiang) Co.,  
Ltd.

No. 318, Jinchuan Road, Xinqian Street,  
Huangyan District, Taizhou City Zhejiang  
Province, China

(540)Madrid Application

**NORA**

(511) 29

(210) No. M/1828712

(220) 18/09/2024

(732) Taokaenoi Food & Marketing Public  
Company Limited

337 Bond Street Road, Bang Phut Sub-district  
11120 Pak Kret District, Nonthaburi  
Province, Thailand

(540)Madrid Application

**TOYILY**

(511) 06, 14, 20, 26 and 28

(210) No. M/1828713

(220) 13/08/2024

(732) Shenzhen Blue Origin Brand Management  
Co., Ltd.

Room 3302, Building 2, Shenzhen New  
Generation Industrial Park, No. 136,  
Zhongkang Road, Meidu Community, Meilin  
Street, Futian District, Shenzhen City  
Guangdong Province, China

(540)Madrid Application

**FLORA FOOD**

(511) 35 and 43

(210) No. M/1828795

(220) 08/11/2024

(732) Flora Food Global Principal B.V.

Beethovenstraat 551–7th floor NL-1083 HK  
Amsterdam, The Netherlands

(540)Madrid Application

**БЕСТРИП**

**BESTTRIP**

(511) 09, 16, 35, 36, 39, 41, 42 and 43

(210) No. M/1829003

(220) 03/04/2024

(732) LIMITED LIABILITY COMPANY

"DATAUNIVERSE"

Leningradsky avenue, 31 A, building. 1,  
room. 4/5, fl./of. 5/15, ext.ter.g. municipal  
district, Begovoy RU-125284 Moscow,  
Russian Federation

(540)Madrid Application

**E11EVEN**

(511) 36

(210) No. M/1829044

(220) 31/07/2024

(732) GR Opco, LLC

29 N.E. 11th Street Miami FL 33132,  
United States of America

(540)Madrid Application

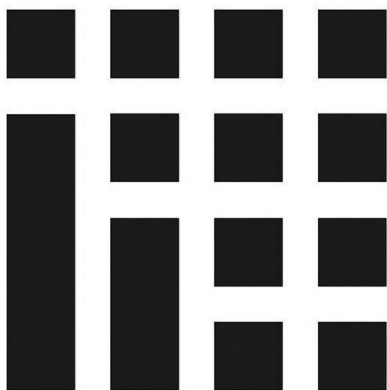

(511) 03 and 21

(210) No. M/1829091

(220) 03/07/2024

(732) Hangzhou Meixi Aesthetics Bio-technology  
Co., LTD

Rm 1512, 15th Floor, Bldg 8, No. 19, Jugong  
Road, Xixing St, Binjiang Dist., Hangzhou  
City 310000 Zhejiang, China

(540)Madrid Application



(511) 16

(210) No. M/1829168

(220) 11/11/2024

(732) SuFeng

No. 21, Xizhuang Group, Shencun  
Community, Shencun Town, Xuanzhou  
District, Xuancheng City 242000 Anhui  
Province, China

(540)Madrid Application



(511) 29 and 30

(210) No. M/1829184

(220) 17/10/2024

(732) HaiXin Foods Co., Ltd.

1# Building, No. 150, Jianxin North Road,  
Jianxin, Cangshan, Fuzhou Fujian, China

(540)Madrid Application



(511) 09, 12 and 35

(210) No. M/1829185

(220) 18/09/2024

(732) HUBEI XINGJI MEIZU GROUP CO., LTD  
NO. B1345 CHUANGGU START-UP  
AREA, TAIZI LAKE CULTURAL AND  
DIGITAL CREATIVE INDUSTRY PARK,  
NO. 18, SHENLONG AVENUE, WUHAN  
ECONOMIC AND TECHNOLOGICAL  
DEVELOPMENT ZONE, WUHAN HUBEI,  
CHINA

(540)Madrid Application

**KAMINOMOTO**

(511) 03 and 05

(210) No. M/1829223

(220) 08/11/2024

(732) KABUSHIKI KAISHA KAMINOMOTO  
HOMPO (KAMINOMOTO CO., LTD.)  
3-25, 3-chome, Kumochibashidori, Chuo-ku,  
Kobe-shi Hyogo-ken 651-0055, Japan

(540)Madrid Application



(511) 03  
(210) No. M/1829263  
(220) 13/11/2024  
(732) Guangzhou Xiaotan Technology Co.,LTD  
Room 2119, No.56, Hanxing Street,  
Zhongcun Street, Panyu District, Guangzhou  
City 511400 Guangdong Province, China

(540)Madrid Application



(511) 03 and 21  
(210) No. M/1829265  
(220) 09/10/2024  
(732) Jiangsu Oppeal Daily Cosmetics Corp., Ltd  
South Huatong Road, Yangshou Town,  
Hanjiang District, Yangzhou City Jiangsu  
Province, China



(540)Madrid Application



(511) 30

(210) No. M/1829268

(220) 14/11/2024

(732) Guangzhou Restaurant Group Co., Ltd.

12th floor (self built 13th floor) full floor unit  
of Ximenkou Plaza Office Tower, No. 50  
Zhongshan 7th Road, Liwan District  
Guangzhou City, Guangdong Province, China

(540)Madrid Application

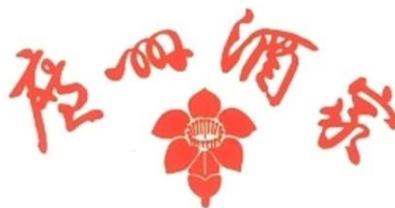

(511) 43

(210) No. M/1829270

(220) 14/11/2024

(732) Guangzhou Restaurant Group Co., Ltd.

12th floor (self built 13th floor) full floor unit  
of Ximenkou Plaza Office Tower, No. 50  
Zhongshan 7th Road, Liwan District  
Guangzhou City, Guangdong Province, China

(540)Madrid Application



(511) 11

(210) No. M/1829271

(220) 18/10/2024

(732) Yang Xiaoli

No. 101, Building 8, Pingning Zhuang,  
Pinghu Garden, Liusha West Sub-District,  
Puning City Guangdong Province, China

(540)Madrid Application



(511) 25

(210) No. M/1829280

(220) 10/10/2024

(732) GUANGZHOU MONTON SPORTS  
PRODUCTS CO., LTD.

4F of Factory, Chigang Village, Shilou Town,  
Panyu District, Guangzhou CityGuang dong  
Province, China

(540)Madrid Application

**AOE VALORE**

(511) 25

(210) No. M/1829284

(220) 10/10/2024

(732) GUANGZHOU MONTON SPORTS  
PRODUCTS CO., LTD.

4F of Factory, Chigang Village, Shilou Town,  
Panyu District, Guangzhou City Guangdong  
Province, China

(540)Madrid Application

**14K**

(511) 29

(210) No. M/1829294

(220) 13/11/2024

(732) McCoy, Archie

905-1 Hikina Lane Honolulu HI 96817,  
United States of America

(540)Madrid Application

**Shaleni<sup>o</sup>**

(511) 03, 10, 14, 18 and 25

(210) No. M/1829337

(220) 26/08/2024

(732) Kiriyakulov Maximus Heorhiiiovych  
vul. Drahomanova, 17, kv. 7 Kyiv 02068,  
Ukraine

(540)Madrid Application

**MAXUM**  
Gypsum for Maximum Quality

(511) 19

(210) No. M/1829366

(220) 31/10/2024

(732) WESTERN DECOR CORPORATION  
PUBLIC COMPANY LIMITED  
1168/81-82, 27th floor, Lumpini Tower,  
Rama 4 Rd., Thungmahamek 10120 Sathorn,  
Bangkok, Thailand

(540)Madrid Application

**Falling Wilds**

(511) 09, 28 and 41

(210) No. M/1829531

(220) 27/08/2024

(732) EGT DIGITAL LTD.

"Panorama Sofia" Str. 6, Business Center

"Richhill", block A BG-1766 Sofia, Bulgaria

(540)Madrid Application

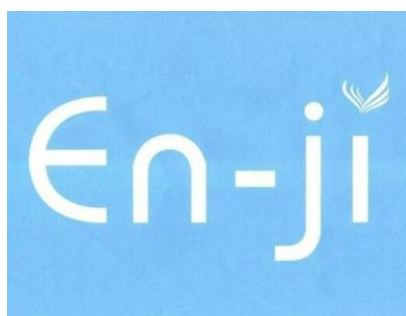

(511) 18

(210) No. M/1829554

(220) 25/10/2024

(732) PT. MENARA INTER MODE

Jl. Bhumimas V, Kawasan Industri dan

Pergudangan, Cikupa Mas No. 8, Talaga,

Cikupa, Kabupaten Tangerang Banten 15710,

Indonesia

(540)Madrid Application



(511) 30

(210) No. M/1829558

(220) 17/09/2024

(732) P.R.Foodland Company Limited

56 Village No.10, Pak chong Sub-district, Pak  
chong District 30130 Nakhon Ratchasima,  
Thailand

(540)Madrid Application

**JIRPET**

(511) 11

(210) No. M/1829590

(220) 19/11/2024

(732) Jirpet (Zhejiang) Technology Co., Ltd.

Room 801, 8th Floor, Building A, 2588  
Sanbei Street, Baisha Road Street, Cixi City  
315302 Zhejiang Province, China

(540)Madrid Application



20 BEER CASH

(511) 09, 28 and 41

(210) No. M/1829668

(220) 16/08/2024

(732) Euro Games Technology Ltd.

Panorama Sofia Str. 6, Richhill Business  
Center, ground floor, Vitosha Region BG-  
1766 Sofia, Bulgaria

(540)Madrid Application



瞬足

(511) 25

(210) No. M/1829799

(220) 16/10/2024

(732) ACHILLES CORPORATION

21-1, Kita-Shinjuku 2-chome, Shinjuku-ku  
Tokyo 169-8885, Japan

(540)Madrid Application

The logo for SYUNSOKU is written in a bold, italicized, black sans-serif font.

(511) 25

(210) No. M/1829837

(220) 16/10/2024

(732) ACHILLES CORPORATION

21-1, Kita-Shinjuku 2-chome, Shinjuku-ku  
Tokyo 169-8885, Japan

(540)Madrid Application

The logo for GRINABLE features the letters 'e', 'CO', and 'GRINABLE' in a green, rounded font. A light green leaf is positioned above the 'e', and a light blue circle is partially visible behind the 'O' in 'CO'. The word 'GRINABLE' is written in a smaller, green, sans-serif font below the 'CO'.

(511) 01 and 17

(210) No. M/1829840

(220) 18/10/2024

(732) ARONKASEI CO., LTD.

2-8-6, Nishi-shimbashi, Minato-ku Tokyo,  
Japan



(540)Madrid Application



(511) 05

(210) No. M/1829895

(220) 25/09/2024

(732) Novartis AG

CH-4002 Basel, Switzerland

(540)Madrid Application



(511) 09, 28 and 41

(210) No. M/1829925

(220) 16/08/2024

(732) Euro Games Technology Ltd.

Panorama Sofia Str. 6, Richhill Business  
Center, ground floor, Vitosha Region BG-  
1766 Sofia, Bulgaria

(540)Madrid Application

The logo for CELIMO features a stylized icon of three horizontal bars with a curved top, followed by the word "CELIMO" in a bold, black, sans-serif font.

(511) 12

(210) No. M/1829934

(220) 23/09/2024

(732) Jiangsu General Science Technology Co.,  
Ltd.

Gangxia, Donggang Town, Xishan District,  
Wuxi City 214199 Jiangsu Province, China

(540)Madrid Application

The logo for 10 BEER CASH features the text "10 BEER CASH" in a bold, 3D-style font with a yellow-to-orange gradient and a metallic texture. The numbers "10" are significantly larger than the words "BEER" and "CASH".

(511) 09, 28 and 41

(210) No. M/1830003

(220) 16/08/2024

(732) Euro Games Technology Ltd.

Panorama Sofia Str. 6, Richhill Business  
Center, ground floor, Vitosha Region BG-  
1766 Sofia, Bulgaria

(540)Madrid Application



(511) 39

(210) No. M/1830206

(220) 15/08/2024

(732) GSM Green and Smart Mobility Joint Stock  
Company

Symphony Office Tower, Chu Huy Man

Street, Vinhomes Riverside Urban Area, Phuc

Loi Ward, Long Bien District Hanoi City,

Vietnam

(540)Madrid Application

Flaming Cash

(511) 09, 28 and 41

(210) No. M/1830228

(220) 16/08/2024

(732) Euro Games Technology Ltd.

Panorama Sofia Str. 6, Richhill Business

Center, ground floor, Vitosha Region BG-

1766 Sofia, Bulgaria

(540)Madrid Application

**Daliyuan**

(511) 29, 30 and 32

(210) No. M/1830229

(220) 25/07/2024

(732) DALI FOODS GROUP LIMITED

Linkou, Zishan Town, Hui'An County,  
Quanzhou 362100 Fujian, China

(540)Madrid Application

**Dalez**

(511) 29, 30 and 32

(210) No. M/1830230

(220) 25/07/2024

(732) DALI FOODS GROUP LIMITED

Linkou, Zishan Town, Hui'An County,  
Quanzhou 362100 Fujian, China

(540)Madrid Application



(511) 16

(210) No. M/1830236

(220) 23/10/2024

(732) PORTA CRAFT PTY LTD

51 Edison Cct Forrestdale WA 6112,  
Australia

(540)Madrid Application

**E11EVEN**

(511) 37

(210) No. M/1830500

(220) 31/07/2024

(732) GR OPCO, LLC

29 N.E. 11 Street Miami FL 33132,  
United States of America

(540)Madrid Application

**AVAC**

(511) 05

(210) No. M/1830601

(220) 21/10/2024

(732) AVAC VIETNAM JOINT STOCK  
COMPANY

National Highway 5A, Ngoc Lich Village,  
Trung Trac Commune, Van Lam District  
Hung Yen Province, Vietnam

(540)Madrid Application

**GOBAO**

(511) 09 and 12

(210) No. M/1830629

(220) 21/08/2024

(732) Guangdong Gobao Intelligent Technology  
Co., Ltd.

NO.3 West Industry Rd, Songshan Lake  
Industrial Park, Dongguan 523429  
Guangdong, China

(540)Madrid Application

**GRIN**

(511) 03, 10 and 21

(210) No. M/1830642

(220) 16/08/2024

(732) Sacks Holdings, Inc.

11440 West Bernardo Court, Suite 250 San  
Diego CA 92127, United States of America

(540)Madrid Application

**E25X**

(511) 07 and 09

(210) No. M/1830749

(220) 08/11/2024

(732) Honor Machinery Co., Pte. Ltd.

7 TEMASEK BOULEVARD, #12-07  
SUNTEC TOWER ONE SINGAPORE  
038987

(540)Madrid Application

**20 BURNING POWER**

(511) 09, 28 and 41

(210) No. M/1830792

(220) 16/08/2024

(732) Euro Games Technology Ltd.

Panorama Sofia Str. 6, Richhill Business  
Center, ground floor, Vitosha Region BG-  
1766 Sofia, Bulgaria

(540)Madrid Application

**VUELTA**

(511) 12

(210) No. M/1830799

(220) 17/07/2024

(732) D.Mag (Kunshan) New Material Technology  
Co.,Ltd.

No. 118 Pengxi South Road, Kunshan  
Development Zone Jiangsu, China



(540)Madrid Application



**Dr. papie**

(511) 10

(210) No. M/1830856

(220) 10/09/2024

(732) STARMED PHARMACEUTICAL GROUP  
JOINT STOCK COMPANY

28-30 TT4A, Van Quan - Yen Phuc Urban  
Area, Phuc La Ward, Ha Dong District Hanoi  
City, Vietnam

(540)Madrid Application



**FGI**

(511) 04, 07, 09, 11 and 37

(210) No. M/1830902

(220) 02/08/2024

(732) WindSun Science & Technology Co., Ltd.  
North of Middle Section of Jincheng Road,  
Economic Development Zone, Wenshang  
County Shandong, China

(540)Madrid Application

**Señor Muerto**

(511) 09, 28 and 41

(210) No. M/1830912

(220) 27/08/2024

(732) EGT DIGITAL LTD.

"Panorama Sofia" Str. 6, Business Center

"Richhill", block A BG-1766 Sofia, Bulgaria

(540)Madrid Application

**Eternal Trinity**

(511) 09, 28 and 41

(210) No. M/1830914

(220) 27/08/2024

(732) Euro Games Technology Ltd.

6 Panorama Sofia Str., Richhill Business

Center, ground floor, Vitosha Region BG-1766

Sofia, Bulgaria

(540)Madrid Application



(511) 03 and 05

(210) No. M/1830998

(220) 06/11/2024

(732) MR. Wongspus Eua-areemitr

18 soi Sathon 15, Yannawa, Sathon 10120

Bangkok, Thailand

(540)Madrid Application



(511) 09, 16, 25, 35, 36, 37, 38, 39, 40, 41, 42, 44  
and 45

(210) No. M/1831066

(220) 24/06/2024

(732) Integrated Design & Engineering Holdings

Co., Ltd.

5-4 Kojimachi, Chiyoda-ku Tokyo 102-8539,

Japan

(540)Madrid Application

The logo for Apple Sports, featuring the Apple logo icon followed by the word "Sports" in a bold, sans-serif font.

(511) 41

(210) No. M/1831070

(220) 10/07/2024

(732) Apple Inc.

One Apple Park Way Cupertino CA 95014,  
United States of America

(540)Madrid Application

**NASHI**

(511) 03

(210) No. M/1831084

(220) 03/08/2024

(732) JETHARAM NEMARAM GEHLOT

101, shree white heights, saraswati nagar,  
hirawadi road, panchavati, nashik maharashtra  
422003, India

(540)Madrid Application



(511) 45

(210) No. M/1831115

(220) 07/11/2024

(732) Guangdong Huashang Law Firm

Floor 21A-3, 22A, 23A, 24A, 25A, 26A of  
Hong Kong China Travel Service Building,  
4011 Shennan Avenue, Futian District,  
Shenzhen 518000 Guangdong Province,  
China

(540)Madrid Application



(511) 16

(210) No. M/1831156

(220) 25/09/2024

(732) Chengdu Quilimen Business Co., Ltd.

No. 221, 2ndFloor, Building 1, No. 99,  
Tianfu 2nd Street, Chengdu Hi-Tech Zone  
610041 Sichuan Pilot Free Trade Zone, China

(540)Madrid Application

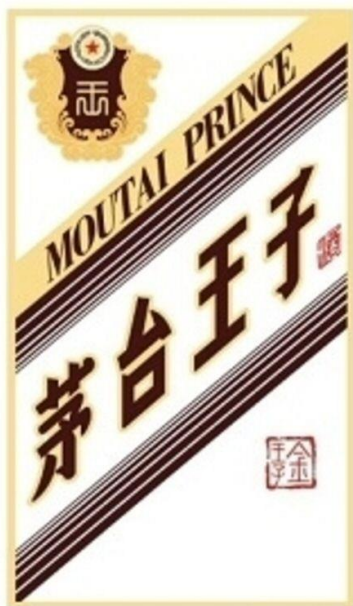

(511) 33

(210) No. M/1831158

(220) 11/11/2024

(732) China Kweichow Moutai Distillery (Group)  
Co., Ltd.

No.4 East Mountain Lane, East Road of  
Outside Loop, Guiyang City Guizhou  
Province, China

(540)Madrid Application

**CHILWEE**

(511) 12

(210) No. M/1831253

(220) 21/06/2024

(732) CHAOWEI POWER GROUP CO., LTD.

Xinxing Industrial Park, Zhicheng Town,  
Changxing County, Huzhou City 313100  
Zhejiang Province, China

(540)Madrid Application



(511) 03

(210) No. M/1831257

(220) 16/10/2024

(732) PHITHANLIFE COMPANY LIMITED

518/5 Building Maneeya Center floor 6,  
Ploenchit Road, Lumpini Sub-district 10330  
Pathumwan district, Bangkok, Thailand

(540)Madrid Application



(511) 43

(210) No. M/1831332

(220) 01/10/2024

(732) HANGUG GROWTH PTE. LTD.

68 ORCHARD ROAD, #02-01 PLAZA  
SINGAPURA SINGAPORE 238839

(540)Madrid Application

**Dazzle Strikes**

(511) 09, 28 and 41

(210) No. M/1831342

(220) 29/08/2024

(732) Euro Games Technology Ltd.

6 Panorama Sofia Str., Richhill Business

Center, ground floor, Vitosha Region BG-1766

Sofia, Bulgaria

(540)Madrid Application

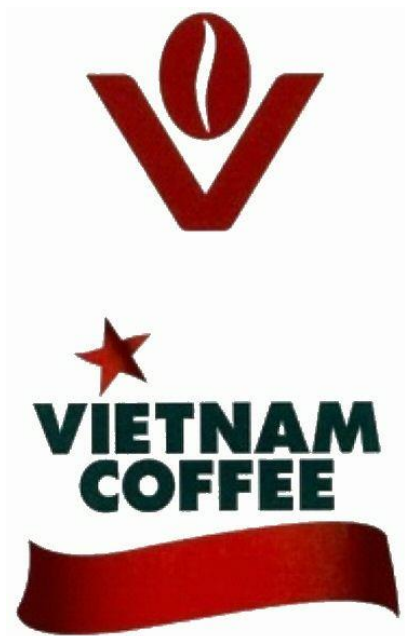

(511) 30

(210) No. M/1831470

(220) 12/09/2024

(732) VIET NAM NATIONAL COFFEE

CORPORATION

211-213-213A Tran Huy Lieu, Ward 08, Phu

Nhuan District Ho Chi Minh City, Vietnam



(540)Madrid Application

*wehag*

(511) 06, 07 and 09

(210) No. M/1831478

(220) 07/11/2024

(732) HOPO INC.

1 Cuttermill Road, suite#4 Great Neck NY  
11021, United States of America

(540)Madrid Application

**DFH**

(511) 09 and 21

(210) No. M/1831616

(220) 20/09/2024

(732) Deng Zhongjiang

Room 702, Building 2, Xinghewan Huixin  
Garden, No. 521 Yingbin Road, Panyu  
District, Guangzhou City 510000 Guangdong  
Province, China

(540)Madrid Application



(511) 03

(210) No. M/1831669

(220) 21/10/2024

(732) Zhejiang Rifeshow Cosmetics Co., Ltd.

No.67 Dashi Road, Fotang Town, Yiwu City  
Zhejiang, China

(540)Madrid Application



(511) 09

(210) No. M/1831827

(220) 13/06/2024

(732) Beijing Laite Linke Photoelectric Technology  
Co., Ltd.

Room 5008, 5th Floor, No. 19 Haidian South  
Road, Haidian District Beijing, China

(540)Madrid Application



(511) 06, 07, 09, 11, 16, 17, 25, 35, 36, 37, 38, 39, 40, 41, 42, 44 and 45

(210) No. M/1831829

(220) 24/06/2024

(732) Integrated Design & Engineering Holdings  
Co., Ltd.  
5-4 Kojimachi, Chiyoda-ku Tokyo 102-8539,  
Japan

(540)Madrid Application



(511) 07, 09, 16, 35, 36, 38, 39 and 42

(210) No. M/1831835

(220) 02/07/2024

(732) Touch 'n Go Sdn Bhd  
Tower 6, Avenue 5, The Horizon, Bangsar  
South, No. 8, Jalan Kerinchi, Wilayah  
Persekutuan 59200 Kuala Lumpur, Malaysia

(540)Madrid Application

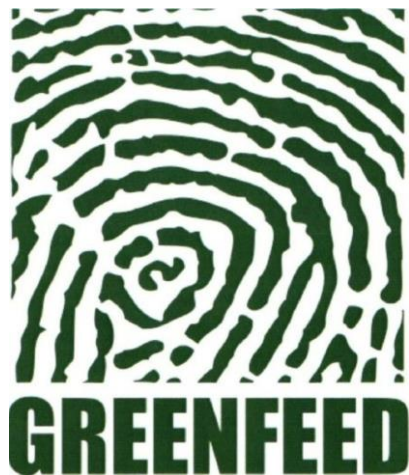

(511) 01 and 16  
(210) No. M/1831883  
(220) 13/08/2024  
(732) GREENFEED AGRO SDN BHD  
UNIT 9-7, 7TH FLOOR, THE  
BOULEVARD MID VALLEY CITY,  
LINGKARAN SYED PUTRA 59200  
KUALA LUMPUR, MALAYSIA

(540)Madrid Application



(511) 35 and 39  
(210) No. M/1831885  
(220) 11/09/2024  
(732) NISSIN CORPORATION  
6-81 Onoecho, Naka-ku, Yokohama-shi  
Kanagawa 2318477, Japan

(540)Madrid Application

**BRINGING LIGHT  
TO LIFE.**

(511) 14 and 35

(210) No. M/1831931

(220) 18/10/2024

(732) Lightbox Jewelry Ltd

17 Charterhouse Street London EC1N 6RA,  
United Kingdom

(540)Madrid Application



(511) 09

(210) No. M/1831979

(220) 10/11/2024

(732) Apple Inc.

One Apple Park Way Cupertino CA 95014,  
United States of America

(540)Madrid Application



(511) 30

(210) No. M/1831981

(220) 30/10/2024

(732) MK Restaurant Group Public Company  
Limited

1200 Debaratna Road, Bangna Tai 10260  
Bangna, Bangkok, Thailand

(540)Madrid Application

**Enertrack**

(511) 06 and 07

(210) No. M/1831993

(220) 01/11/2024

(732) Enertrack Technology Co., Ltd.

Building B1, Taohua Science and Technology  
Innovation Valley, 200 meters east from the  
intersection of Yonghe Road and Mingchuan  
Road, Taohua Town, Feixi County, Hefei City  
Anhui Province, China

(540)Madrid Application

**Aridge**

(511) 09, 12 and 37

(210) No. M/1832010

(220) 22/11/2024

(732) Guangdong Huitian Aerospace Technology  
Co., Ltd.

No. 318 Waihuanxi Road, Higher Education  
Mega Center, Xiaoguwei Street, Panyu  
District, Guangzhou Guangdong Province,  
China

(540)Madrid Application

**เครื่องต้น**  
KREUNGTON 肯动

(511) 30

(210) No. M/1832171

(220) 23/11/2024

(732) THUNTOUCH INTERTRADE COMPANY  
LIMITED

44, 46 Soi Thian Thale 8, Bang Khun Thian  
Chai Thale Road, Samae Dam 10150 Bang  
Khun Thian, Bangkok, Thailand

(540)Madrid Application

The logo for 'wendays' is written in a lowercase, elegant, cursive script font.

(511) 05

(210) No. M/1832172

(220) 23/11/2024

(732) Dot Dash Dash Co., Ltd.

22/14 Sukhaphiban 2 Road, Prawet

Subdistrict 10250 Prawet District, Bangkok,

Thailand

(540)Madrid Application

The logo for 'ZENFRY' is written in a bold, uppercase, blocky font with a thick, dark outline and a slight 3D effect.

(511) 29

(210) No. M/1832175

(220) 23/11/2024

(732) SMILE FARM FOOD &SERVICE

COMPANY LIMITED

206/103 KANLAPAPHRUEK ROAD,

BANG WA 10160 PHASI CHAROEN,

BANGKOK, THAILAND



(540)Madrid Application



(511) 36, 37, 39 and 42

(210) No. M/1832332

(220) 29/10/2024

(732) Nishimatsu Construction Co., Ltd.

17-1, Toranomom 1-chome, Minato-ku Tokyo  
105-6407, Japan

(540)Madrid Application



(511) 01

(210) No. M/1832359

(220) 23/11/2024

(732) Eden Agritech Co., Ltd.

188/147 Moo 6, Bang Kruai Sub-district  
11130 Bang Kruai District, Nonthaburi,  
Thailand

(540)Madrid Application



(511) 12

(210) No. M/1832360

(220) 23/11/2024

(732) S. R. Tyres Co., Ltd.

222 Moo 1, Suwinthawong Rd., Khokthai  
Sub-district 25190 Srimahosot District,  
Prachinburi, Thailand

(540)Madrid Application

**RLUX**

(511) 03, 09, 14, 18, 25, 35 and 39

(210) No. M/1832365

(220) 06/11/2024

(732) Coupang Corp.

18th Floor (Sincheon-dong), 570 Songpa-  
daero, Songpa-gu, Seoul, Republic of Korea

(540)Madrid Application



(511) 41

(210) No. M/1832454

(220) 20/11/2024

(732) Mr.Somsak Inpuek

50/10, Nongkham Community, Moo 7,

Tambon Nikomsangtoneng, Amphur Muang

15000 Lopburi Province, Thailand

(540)Madrid Application



(511) 30

(210) No. M/1832526

(220) 04/10/2024

(732) ITALPO ENTERPRISE S.R.L.

Via Manara Negrone, 29 I-27020 Albonese

(PV), Italy

(540)Madrid Application

**BIG OLITA**

(511) 25

(210) No. M/1832582

(220) 05/12/2024

(732) Industria de Diseño Textil, S.A. (Inditex, S.A.)

Avenida de la Diputación, Edificio Inditex,  
Arteixo E-15143 A Coruña, Spain

## ພາກທີ IV

### (Part IV)

## ເຄື່ອງໝາຍການຄ້າຜ່ານລະບົບມາດຣິດ

### Trademarks via Madrid Protocol

#### 2. ຜົນການຈົດທະບຽນ

##### (Registration)

##### ຄຳອະທິບາຍກ່ຽວກັບລະຫັດຫຍໍ້

##### (Introduction of Codes)

- (540) ເຄື່ອງໝາຍການຄ້າ (Trademark)
- (511) ໝວດ (Nice Classification)
- (210) ເລກທີ ຄຳຮ້ອງ (Number of the application)
- (220) ວັນທີ ຍື່ນຄຳຮ້ອງ (Date of filing of the application)
- (732) ຊື່ ແລະ ທີ່ຢູ່ ຂອງຜູ້ຍື່ນຄຳຮ້ອງ (Name and Address of applicant)
- (111) ເລກທີການຈົດທະບຽນເຄື່ອງໝາຍການຄ້າ (Number of the registration)
- (180) ວັນໝົດອາຍຸຂອງການຈົດທະບຽນ (Expiration date of the registration)

## ພາກທີ IV

### (Part IV)

## ເຄື່ອງໝາຍການຄ້າຜ່ານລະບົບມາດຣິດ

### Trademarks via Madrid Protocol

#### 3. ຜົນການຕໍ່ອາຍຸ

##### (Renewal)

##### ຄຳອະທິບາຍກ່ຽວກັບລະຫັດຫຍໍ້

##### (Introduction of Codes)

- (540) ເຄື່ອງໝາຍການຄ້າ (Trademark)
- (511) ໝວດ (Nice Classification)
- (210) ເລກທີ ຄຳຮ້ອງ (Number of the application)
- (220) ວັນທີ ຍື່ນຄຳຮ້ອງ (Date of filing of the application)
- (732) ຊື່ ແລະ ທີ່ຢູ່ ຂອງຜູ້ຍື່ນຄຳຮ້ອງ (Name and Address of applicant)
- (111) ເລກທີການຈັດທະບຽນເຄື່ອງໝາຍການຄ້າ (Number of the registration)
- (180) ການຕໍ່ອາຍຸຂອງການຈັດທະບຽນ (Expiration date of the renewal)

**ພາກທີ IV**

**(Part IV)**

**ເຄື່ອງໝາຍການຄ້າຜ່ານລະບົບມາດຣິດ**

**Trademarks via Madrid Protocol**

**4. ການປ່ຽນແປງ**

**(Changes)**

**ພາກທີ IV**

**(Part IV)**

**ເຄື່ອງໝາຍການຄ້າຜ່ານລະບົບມາດຣິດ**

**Trademarks via Madrid Protocol**

**5. ການດັດແກ້**

**(Amendments)**



**ພາກທີ V**  
**(Part V)**  
**ຖິ່ນກຳເນີດ**  
**Geographical Indications**

**1. ຄຳຮ້ອງ**  
**(Applications)**

**ພາກທີ V**  
**(Part V)**  
**ຖິ່ນກຳເນີດ**  
**Geographical Indications**

**2. ຜົນການຈົດທະບຽນ**  
**(Registration)**

**ພາກທີ V**  
**(Part V)**  
**ຖິ່ນກຳເນີດ**  
**Geographical Indications**

**2.1 ຜົນການຈົດທະບຽນ ຜ່ານລະບົບສາກົນ**  
**(Lisbon Registration)**

**ພາກທີ V**  
**(Part V)**  
**ຖິ່ນກຳເນີດ**  
**Geographical Indications**

**2.2 ຜົນການຈົດທະບຽນ ຊື່ຖິ່ນກຳເນີດສະເພາະ ຜ່ານລະບົບສາກົນ**  
**(Lisbon Appellation of Origin Registration)**

**ພາກທີ V**

**(Part V)**

**ຖິ່ນກຳເນີດ**

**Geographical Indications**

**3. ການປ່ຽນແປງ**

**(Changes)**

**ພາກທີ V**  
**(Part V)**  
**ຖິ່ນກຳເນີດ**  
**Geographical Indications**

**4. ການດັດແກ້**  
**(Amendments)**

**ພາກທີ VI**

**(Part VI)**

**ພັນພືດໃໝ່**

**New Plant Varieties**

**1. ຄໍາຮ້ອງ**

**(Applications)**

**ພາກທີ VI**

**(Part VI)**

**ພັນພືດໃໝ່**

**New Plant Varieties**

**2. ຜົນການຈັດທະບຽນ**

**(Registration)**



**ພາກທີ VI**  
**(Part VI)**

**ພັນພືດໃໝ່**  
**New Plant Varieties**

**3. ການປ່ຽນແປງ**  
**(Changes)**

**ພາກທີ VI**

**(Part VI)**

**ພັນພືດໃໝ່**

**New Plant Varieties**

**4. ການດັດແກ້**

**(Amendments)**

**ພາກທີ VII**

**(Part VII)**

**ລິຂະສິດ ແລະ ສິດກ່ຽວຂ້ອງກັບລິຂະສິດ**

**Copyrights and Related Rights**

**1. ການແຈ້ງຂໍ້ມູນ**

**(Notifications)**

**ພາກທີ VII**

**(Part VII)**

**ລິຂະສິດ ແລະ ສິດກ່ຽວຂ້ອງກັບລິຂະສິດ**

**Copyrights and Related Rights**

**2. ການປ່ຽນແປງ**

**(Changes)**

**ພາກທີ VIII**

**(Part VIII)**

**ການແກ້ໄຂຂໍ້ຂັດແຍ່ງທາງດ້ານບໍລິຫານກ່ຽວກັບການຈົດ**

**ທະບຽນຊັບສິນອຸດສາຫະກຳ ແລະ ພັນພືດໃໝ່**

**Administrative Dispute Resolutions on the Registration of  
Industrial Property and New Plant Varieties**

**1. ຜົນການຄັດຄ້ານຄຳຮ້ອງ**

**(Result of Oppositions)**

**ພາກທີ VIII**

**(Part VIII)**

**ການແກ້ໄຂຂໍ້ຂັດແຍ່ງທາງດ້ານບໍລິຫານກ່ຽວກັບການຈົດ**

**ທະບຽນຊັບສິນອຸດສາຫະກຳ ແລະ ພັນພືດໃໝ່**

**Administrative Dispute Resolutions on the Registration of  
Industrial Property and New Plant Varieties**

**2. ຜົນການແຈ້ງປະຕິເສດ**

**(Result of Refusals)**

**ພາກທີ VIII**

**(Part VIII)**

**ການແກ້ໄຂຂໍ້ຂັດແຍ່ງທາງດ້ານບໍລິຫານກ່ຽວກັບການຈົດ  
ທະບຽນຊັບສິນອຸດສາຫະກຳ ແລະ ພັນພືດໃໝ່**

**Administrative Dispute Resolutions on the Registration of  
Industrial Property and New Plant Varieties**

**3. ຜົນການຍົກເລີກ ຫຼື ລົບລ້າງ ຂອງການຈົດທະບຽນ  
(Result of Cancellation or Invalidation of Registration)**