



ສາທາລະນະລັດ ປະຊາທິປະໄຕ ປະຊາຊົນລາວ  
LAO PEOPLE'S DEMOCRATIC REPUBLIC

ກະຊວງ ອຸດສາຫະກຳ ແລະ ການຄ້າ  
ກົມຊັບສິນທາງປັນຍາ

MINISTRY OF INDUSTRY AND COMMERCE  
DEPARTMENT OF INTELLECTUAL PROPERTY

ຈົດໝາຍເຫດທາງລັດຖະການ  
ກ່ຽວກັບ ຊັບສິນທາງປັນຍາ  
ຢູ່ ສປປ ລາວ

OFFICIAL GAZETTE ON INTELLECTUAL PROPERTY  
IN LAO PDR

ສະບັບທີ (Vol.) 351

# ພາກທີ I

## (Part I)

### ສິດທິບັດ ແລະ ອະນຸສິດທິບັດ (Patent and Petty Patent)

#### 1. ຄໍາຮ້ອງ (Applications)

##### ຄໍາອະທິບາຍກ່ຽວກັບລະຫັດຫຍໍ້ (Introduction of Codes)

- (21) ເລກທີ ຄໍາຮ້ອງ (Filing Number)
- (22) ວັນທີ ຍືນຄໍາຮ້ອງ (Filing Date)
- (30) ວັນທີ ບຸລິມະສິດ (Priority Date)
- (43) ວັນທີເຜີຍແຜ່ (Publication Date)
- (51) ໝວດ (International Patent Classification)
- (54) ຊື່ຂອງການປະດິດ (Title)
- (57) ບົດຄັດຫຍໍ້ (Abstract)
- (71) ຊື່ ແລະ ທີ່ຢູ່ ເຈົ້າຂອງສິດທິບັດ ແລະ ອະນຸສິດທິບັດ (Owner Name and Address)
- (72) ຊື່ຜູ້ປະດິດ (Inventor Name)
- (74) ຊື່ຕົວແທນ (Representative Name)
- (55) ຮູບພາບ (Pictures)

- (21) No. PT 905
- (22) 03/08/2023
- (30) JP2021-184271 11/11/2021 JP
- (43)
- (51) Int.Cl.2018.01D 01F 6/60(2006.01), D 01F 8/12(2006.01), A 41G 3/00(2006.01)
- (54) FIBER FOR ARTIFICIAL HAIR, AND WIG
- (57) A problem to be solved of the invention is to provide a fiber for artificial hair comprising polyamide, which has a glossy feeling with suppressed luster similar to natural hair, is excellent in persistent antistatic properties, and also excellent in heat-setting properties. The means for solving the problem is a fiber for artificial- hair comprising a thermoplastic polyamide and a polymeric antistatic agent having compatibility with the thermoplastic polyamide, wherein the polymeric antistatic agent has a melting point equal to or lower than the melting point of the thermoplastic polyamide..
- (71) ADERANS COMPANY LIMITED  
6-3, Shinjuku 1-chome, Shinjuku-ku, Tokyo 1608429, Japan.
- (72) SATO, Shunsuke; MATSUMOTO, ShihO and SUGAWARA, Fumitaka.
- (74) Tilleke & Gibbins Lao Co., Ltd.
- (55)

Fig. 1

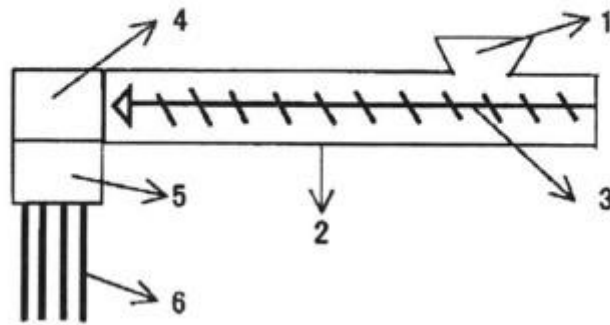

- (21) No. PT 911
- (22) 28/08/2023
- (30) 13/136,474 01/08/2011 US and 61/469,537 30/03/2011 US
- (43)
- (51) Int.Cl.2018.01C 02F 1/00(2006.01)
- (54) METHOD AND SYSTEM FOR TREATING WATER USED FOR INDUSTRIAL PURPOSES
- (57) A low cost method and system for treating water, which will be used in an industrial process, is provided. A system of the invention generally includes at least one containing means, at least one coordination means, at least one chemical application means, at least one mobile suction means, and at least one filtration means. The coordination means can control the necessary processes depending on the system needs (e.9., water quality or purity). The method and system of the invention purifies the water and eliminates suspended solids without the need of filtering the totality of the water volume, but only filtering a small fraction of up to 200 times less than the flow filtered by a conventional water treatment filtration system..
- (71) Crystal Lagoons (Curacao) B.V.  
Kaya W.F.G. (Jombi) Mensing, 14 Curacao, Netherlands, The Netherlands.
- (72) FISCHMANN T., Fernando.
- (74) Tilleke & Gibbins Lao Co., Ltd.
- (55)

**Figure 1**

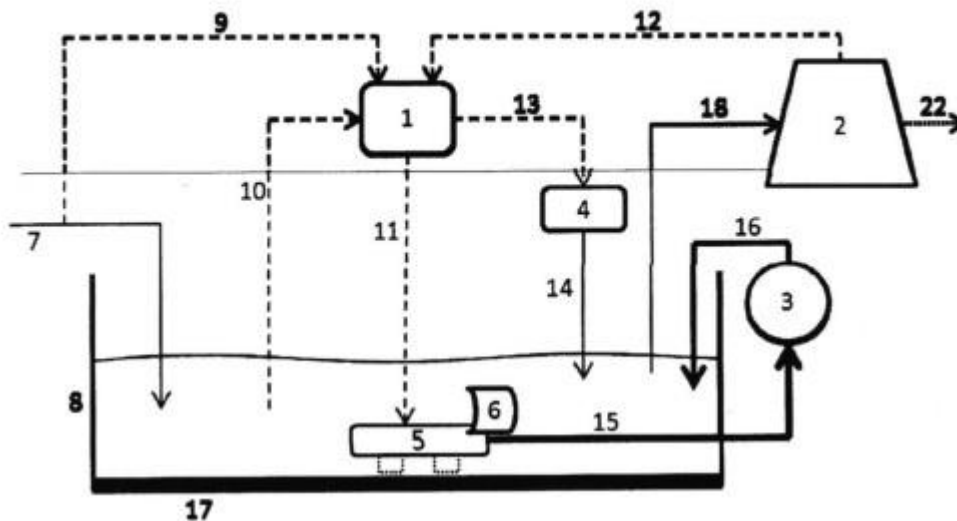

- (21) No. PT 912
- (22) 28/08/2023
- (30) 13/195,695 01/08/2011 US
- (43)
- (51) Int.Cl.2018.01E 01H 1/08(2006.01)
- (54) METHOD AND SYSTEM FOR THE SUSTAINABLE COOLING OF INDUSTRIAL PROCESSES
- (57) A method and system for treating water, and using the treated water for the cooling of industrial processes is disclosed. The water is treated and stored in a large container or artificial lagoon, has high clarity and high microbiological quality. A system of the invention generally includes a containing means, such as a large container or artificial lagoon, a coordination means, a chemical application means, a mobile suction means, and a filtration means, The coordination means monitors and controls the processes in order to adjust water quality parameters within specified limits. The large container of artificial lagoon can act as a heat sink, absorbing waste heat from the industrial cooling process, thus creating thermal energy reservoirs in a sustainable manner, which can be later used for other purposes. The method and system can be used in any industrial cooling system with any type of water available, including fresh water, brackish water, and seawater..
- (71) CRYSTAL LAGOONS (CURACAO) B.V.  
Kaya W.F.G. (Jombi) Mensing, 14 Curacao Netherlands, The Netherlands.
- (72) FISCHMANN T., Fernando.
- (74) Tilleke & Gibbins Lao Co., Ltd.
- (55)

Figure 1

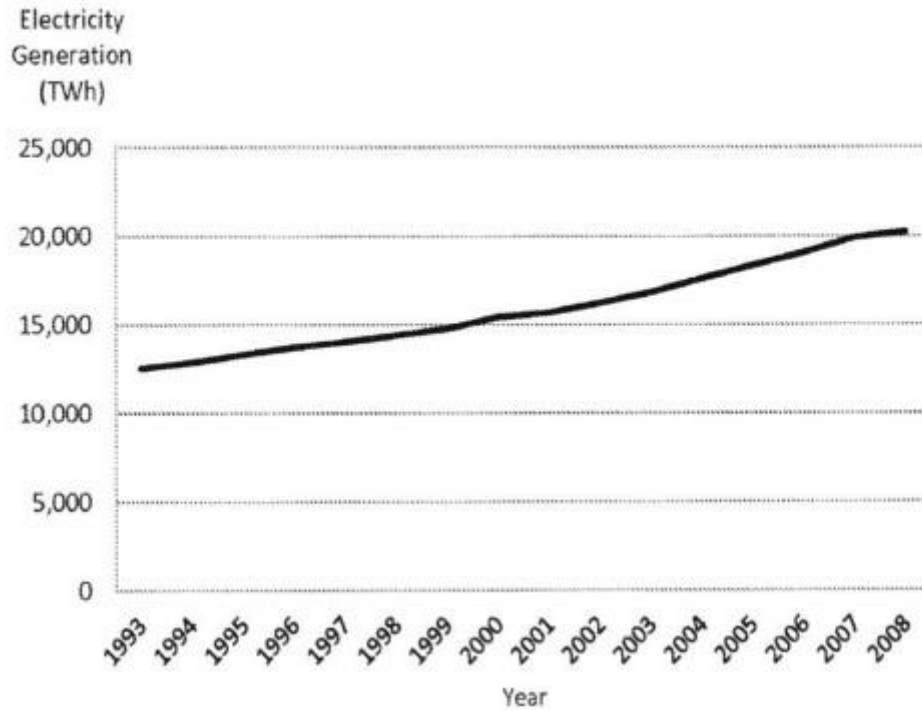

- (21) No. PT 918
- (22) 12/09/2023
- (30) SG10201603678X 27/06/2012 SG
- (43)
- (51) Int.Cl.2018.01H 04S 7/00(2006.01), H 04S 3/00(2006.01)
- (54) SYSTEM AND TOOLS FOR ENHANCED 3D AUDIO AUTHORIZING AND RENDERING
- (57) ເຄື່ອງມືທີ່ໄດ້ຮັບການພັດທະນາສໍາລັບການຂຽນ ແລະ ການສ້າງພາບຈາກແບບຈໍາລອງຂໍ້ມູນການຂະຫຍາຍສຽງແມ່ນໄດ້ຮັບການສະໜອງ. ບາງເຄື່ອງມືການຂຽນດັ່ງກ່າວນັ້ນຊ່ວຍສາມາດສະຫຼຸບຂໍ້ມູນການຂະຫຍາຍສຽງສໍາລັບສະພາບແວດລ້ອມການຂະຫຍາຍທີ່ຫຼາກຫຼາຍ. ຂໍ້ມູນການສ້າງສຽງອາດຖືກຂຽນຂຶ້ນໂດຍການສ້າງຂໍ້ມູນເມຕາສໍາລັບວັດຖຸສຽງ. ຂໍ້ມູນເມຕາອາດຖືກສ້າງຂຶ້ນໂດຍອີງຕາມຂອບເຂດຂອງລໍາໂພງ. ໃນລະຫວ່າງຂະບວນການສ້າງພາບຈາກແບບຈໍາລອງ, ຂໍ້ມູນການຂະຫຍາຍສຽງອາດຈະຖືກໃໝ່ຕາມໂຄງຮ່າງ ລໍາໂພງຂອງສະພາບແວດລ້ອມຂອງການຂະຫຍາຍສຽງສະເພາະ..
- (71) Dolby Laboratories Licensing Corporation, United States of America.
- (72) TSINGOS, Nicolas R. - American; ROBINSON, Charles Q. - American and SCHARPF, Jurgen W. - American.
- (74) ACTIP (LAO) IP CO., LTD..
- (55)

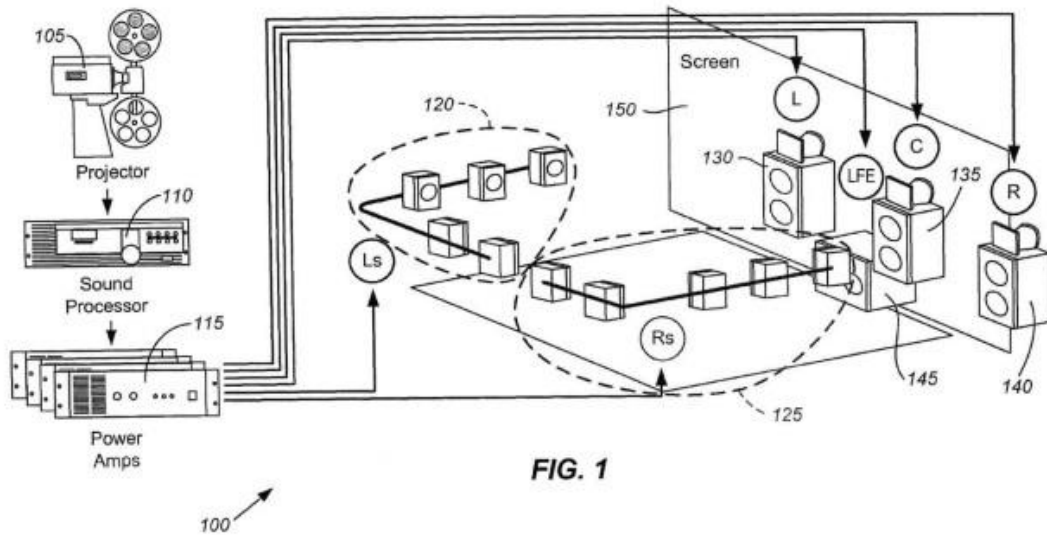
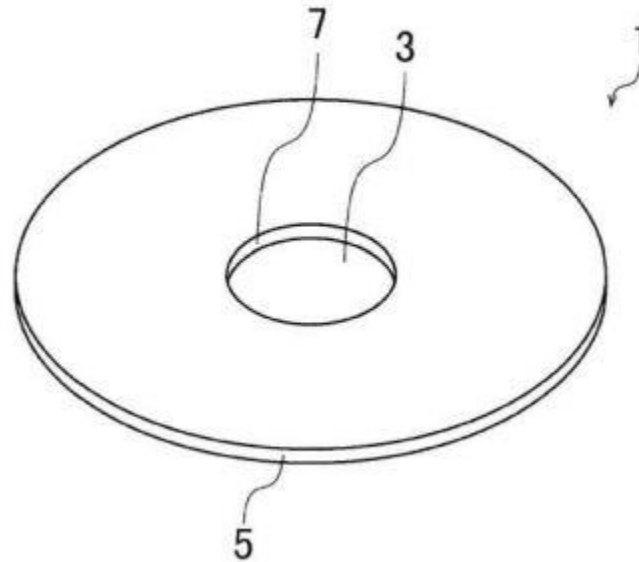

FIG. 1

- (21) No. PT 921
- (22) 14/09/2023
- (30)
- (43)
- (51) Int.Cl.2018.01C 03C 19/00(2006.01), G 11B 5/84(2006.01), G 11B 5/73(2006.01), B 24B 9/00(2006.01), B 24B 1/00(2006.01)
- (54) MAGNETIC DISK SUBSTRATE, MAGNETIC DISK, ANNULAR-SHAPED SUBSTRATE, AND METHOD FOR MANUFACTURING MAGNETIC DISK SUBSTRATE
- (57) A magnetic disk substrate according to an embodiment includes two main surfaces and an outer circumferential edge surface. In the magnetic-disk substrate, the outer circumferential edge surface includes two chamfered surfaces that are respectively connected to the main surfaces, and a side wall surface that is curved and extends to protrude outward between the two chamfered surfaces. The side wall surface has a radius of curvature of  $1100 \text{ Irm}$  or more on a cross-section of the magnetic-disk substrate extending along a plate thickness direction of the magnetic-disk substrate..
- (71) HOYA CORPORATION  
6-10-1 Nishi-Shinjuku, Shinjuku-ku, Tokyo 1608347, Japan.
- (72) Shuhei and Toshio TAKIZAWA.
- (74) Tilleke & Gibbins Lao Co., Ltd.
- (55)



Official Gazette of Industrial Property Vol. 351, 10/04/2026

- (21) No. PT 928
- (22) 10/10/2023
- (30) 2103455.8 12/03/2021 GB
- (43)
- (51) Int.Cl.2018.01G 01F 23/292(2006.01), G 01F 1/00(2006.01), G 01G 11/00(2006.01), E 02F 7/02(2006.01), E 21C 47/04(2006.01), B 65G 41/00(2006.01), B 65G 43/08(2006.01)
- (54) ເຄື່ອງແລ່ນສາຍພານ
- (57) ການເປີດເຜີຍແມ່ນກ່ຽວຂ້ອງກັບອຸປະກອນເຄື່ອງປັ່ນ, ລະບົບວິທີການນຳໃຊ້ກັບການເຄື່ອນໄຫວຂອງວັດສະດຸຫຼາຍ ແລະ ໂດຍສະເພາະສຳລັບການເຄື່ອນໄຫວຂອງການແລ່ນຫຼາຍອຸປະກອນການຂຸດຄົ້ນບໍ່ແຮ່ຈາກສະຖານທີ່ເຮັດວຽກ. ໂດຍສະເພາະ, ອຸປະກອນເຄື່ອງປັ່ນໄດ້ຖືກເປີດເຜີຍປະກອບດ້ວຍ: ອຸປະກອນອາຫານທີ່ມີຈຸດຮັບວັດສະດຸສຳລັບຮັບວັດສະດຸ; ວັດສະດຸຂອງສິ່ນທີ່ໄດ້ຮັບວັດສະດຸ; ສາຍພານທີ່ບໍ່ມີສິ້ນສຸດເພື່ອກຳນົດຜິວລຳລຽງລະຫວ່າງປາຍຮັບວັດສະດຸ ແລະ ສິ້ນສາມາດເຄື່ອນຍ້າຍໄດ້ໃນການນຳໃຊ້ເພື່ອເຮັດໃຫ້ວັດສະດຸທີ່ໄດ້ຮັບໃນຕອນທ້າຍຮັບວັດສະດຸຖືກສົ່ງກັບທ້າຍການໄຫຼຂອງວັດສະດຸ, ໃນນັ້ນ ເຄື່ອງລຳລຽງທີ່ບໍ່ມີສິ້ນສຸດປະກອບດ້ວຍຫຼາຍຂອງໂລຫະ arrayed ຢ່າງຕໍ່ເນື່ອງ. ຈານ, ໝໍ້ ຫຼື ຖ້ຽວບິນ; ອຸປະກອນຕິດຕາມການໄຫຼຂອງວັດສະດຸທີ່ຖືກຖິ້ມຢູ່ໃນສະມາຄົມກັບອຸປະກອນອາຫານ ແລະ ດັດແປງເພື່ອໃຫ້ໄດ້ໃນການນຳໃຊ້ຕົວແທນການວັດແທກຂອງປະລິມານຂອງວັດສະດຸທີ່ຜ່ານໜ້າຕີນຂອງລຳລຽງທີ່ບໍ່ມີວັນສິ້ນສຸດ; ໃນນັ້ນ ອຸປະກອນຕິດຕາມການໄຫຼຂອງວັດສະດຸແມ່ນປັບຕົວເພື່ອໃຫ້ໄດ້ຮັບຕົວແທນການວັດແທກຂອງນ້ຳຂອງອຸປະກອນທີ່ຜ່ານການລຳລຽງໄດ້.
- (71) MMD GROUP LIMITED  
The House of Sizers, The Promenade, Laxey IM4 7DB (GB), United Kingdom.
- (72) PEARSON, Christopher.
- (74) Lao Trademark Agency.
- (55)

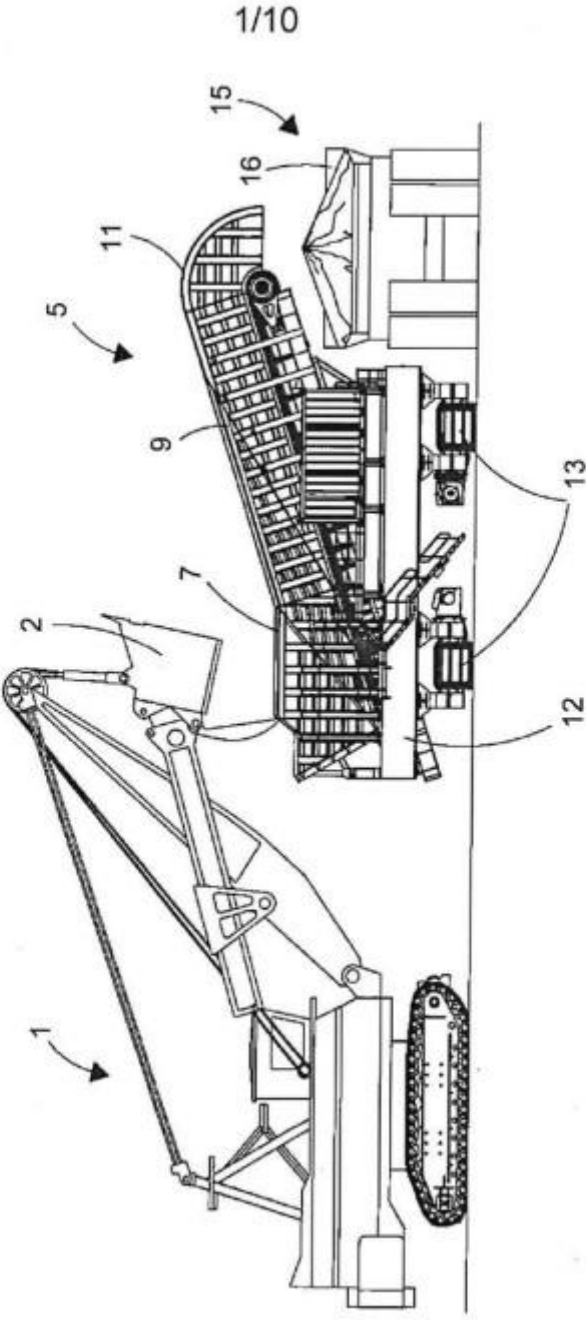

FIG. 1

Official Gazette of Industrial Property Vol. 351, 10/04/2026

- (21) No. PT 932  
(22) 14/11/2023  
(30)  
(43)  
(51) Int.CI.2018.01H 02H 1/00(2006.01), H 02J 13/00(2006.01), G 08B 19/00(2006.01)  
(54) INTELLIGENT TRANSFORMER MONITORING SYSTEM  
(57) An intelligent transformer monitoring system to detect and monitor random failures in distribution transformers due to improper usage and poor maintenance is provided. The intelligent transformer monitoring system includes a GSM-GPRS, a measurement and instrumentation module, a control relay module, a Trivector energy measurement, and a GPS module. The GSM-GPRS includes microcontroller along with GSM-GPRS modem in order to execute remote communication on GSM-GPRS. The Measurement and Instrumentation module includes eleven temperature measurement channels with 8-digital temperature sensors and 3-RTD. The control relay module includes 4 SPDT relays to execute output controls such as load trip and cooling motor etc. The GPS module acquires the latitude, longitude and time data from the satellite for location sharing. The Power supply module is an AC/DC SMPS power supply to convert 240V/415V AC to 12VDC for the intelligent transformer monitoring system.
- (71) ISCIENIFIC TECHSOLUTIONS LABS  
133/1/B, 1ST FLOOR, PHASE-II, IDA, CHERLAPALLY, GHATKESAR MANDAL,  
RANGAREDDY DIST, HYDERABAD 500051 TELANGANA, INDIA.
- (72) RAO K, NARASIMHA.  
(74) HAVIP (LAOS) INTELLECTUAL PROPERTY LAW SOLE CO., LTD..  
(55)

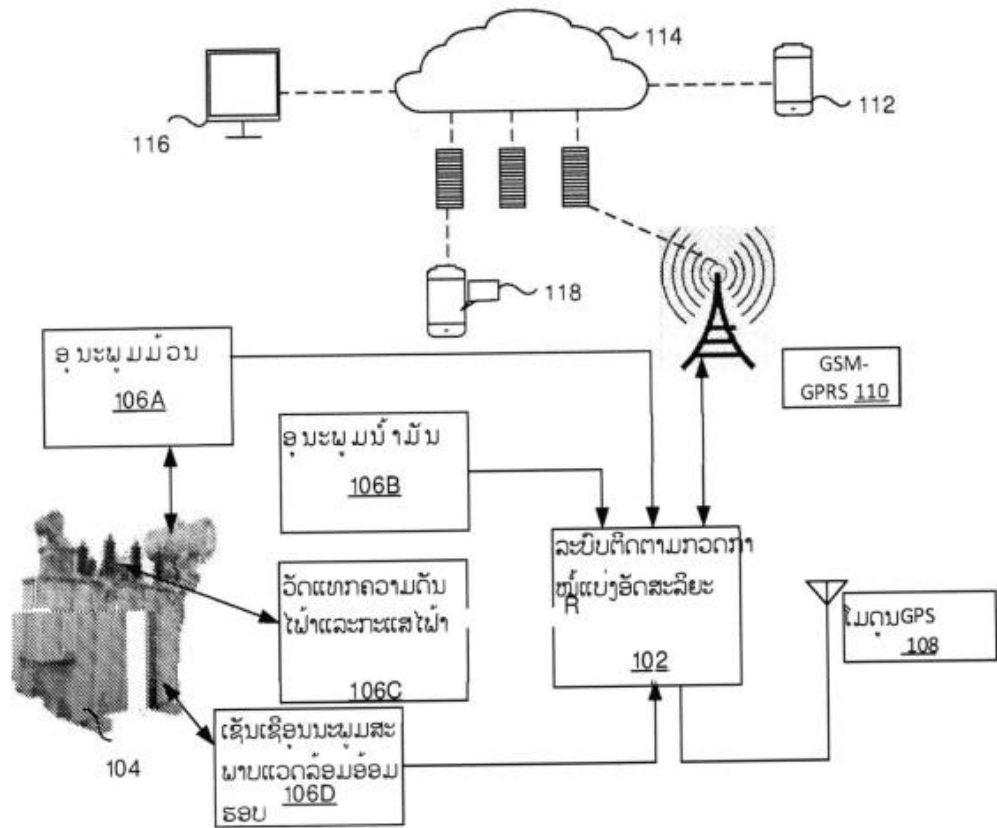

FIG.1

- (21) No. PT 938  
(22) 29/12/2023  
(30)  
(43)  
(51) Int.Cl.2018.01A 61K 36/736(2006.01), A 61K 9/00(2006.01), A 61K 9/16(2006.01), A 61K 9/20(2006.01), A 61K 9/48(2006.01), A 61P 11/00(2006.01), A 61P 31/12(2006.01), A 61P 31/16(2006.01)  
(54) TRADITIONAL CHINESE MEDICINE COMPOSITION FOR TREATING COLD IN CHILDREN  
(57) The present invention seeks to protect a traditional Chinese medicine composition for treating cold of children. The traditional Chinese medicine composition is composed of the following raw materials in parts by weight: 250-400 parts of Fructus Forsythia, 250-400 parts of Lonicera Flos, 50-150 parts of ephedra, 50-150 parts of bitter apricot seed, 250-400 parts of gypsum, 250-400 parts of Radix Isatidis, 50-150 parts of Herba Pogostemonis, 30-90 parts of Radix et Rhizome Rhei, 10-50 parts of Herba Rhodiolae, 120-280 parts of Menthae Haplocalycis Herba, and 50-150 parts of Radix Glycyrrhizae. The experimental results show that the medicament of the present invention has a remarkable effect on common cold and influenza..  
(71) HEBEI YILING MEDICINE RESEARCH INSTITUTE CO. LTD  
238 Tianshan Street, Hi-tech Development Zone, Shijiazhuang City, Hebei Province, 050035, China.  
(72) Zhenhua JIA.  
(74) Lao Trademark Agency.  
(55)

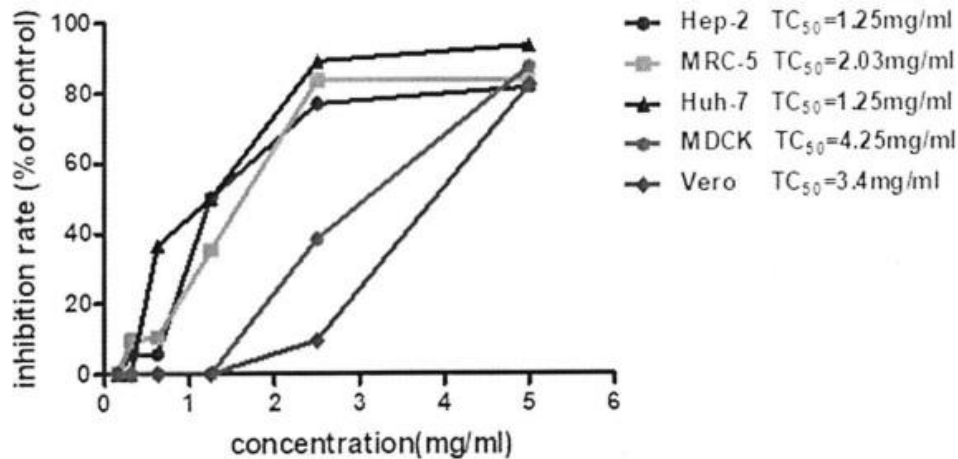

FIG. 1

- (21) No. PT 953
- (22) 16/05/2024
- (30)
- (43)
- (51) Int.Cl.2018.01C 07K 16/18(2006.01), C 12N 15/13(2006.01), A 61K 39/395(2006.01), A 61P 17/00(2006.01), A 61P 35/00(2006.01)
- (54) Method Of Fabricating A Catalyst On A Substrate
- (57) A method of fabricating a catalyst on a substrate comprising: providing a substrate having a layer of metal thereon; and contacting the layer of metal with a corrosive solution to form the catalyst..
- (71) Australian National University  
Acton Australian capital Territory 2601, Australia.
- (72) Siva Krishna KARUTURI; Chennupati JAGADISH; Hark Hoe TAN; Bikesh GUPTA and Joshua Zheyuan SOO.
- (74) Lao Trademark Agency (LAO IP AGENCY).
- (55)

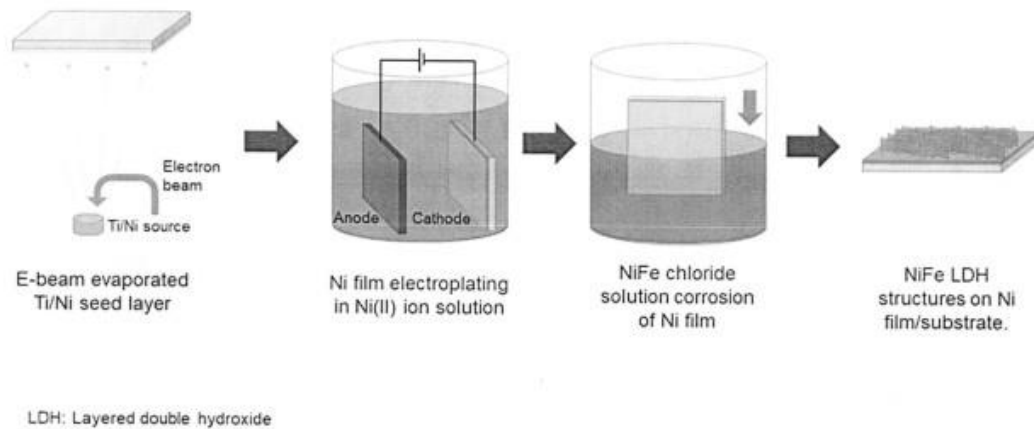
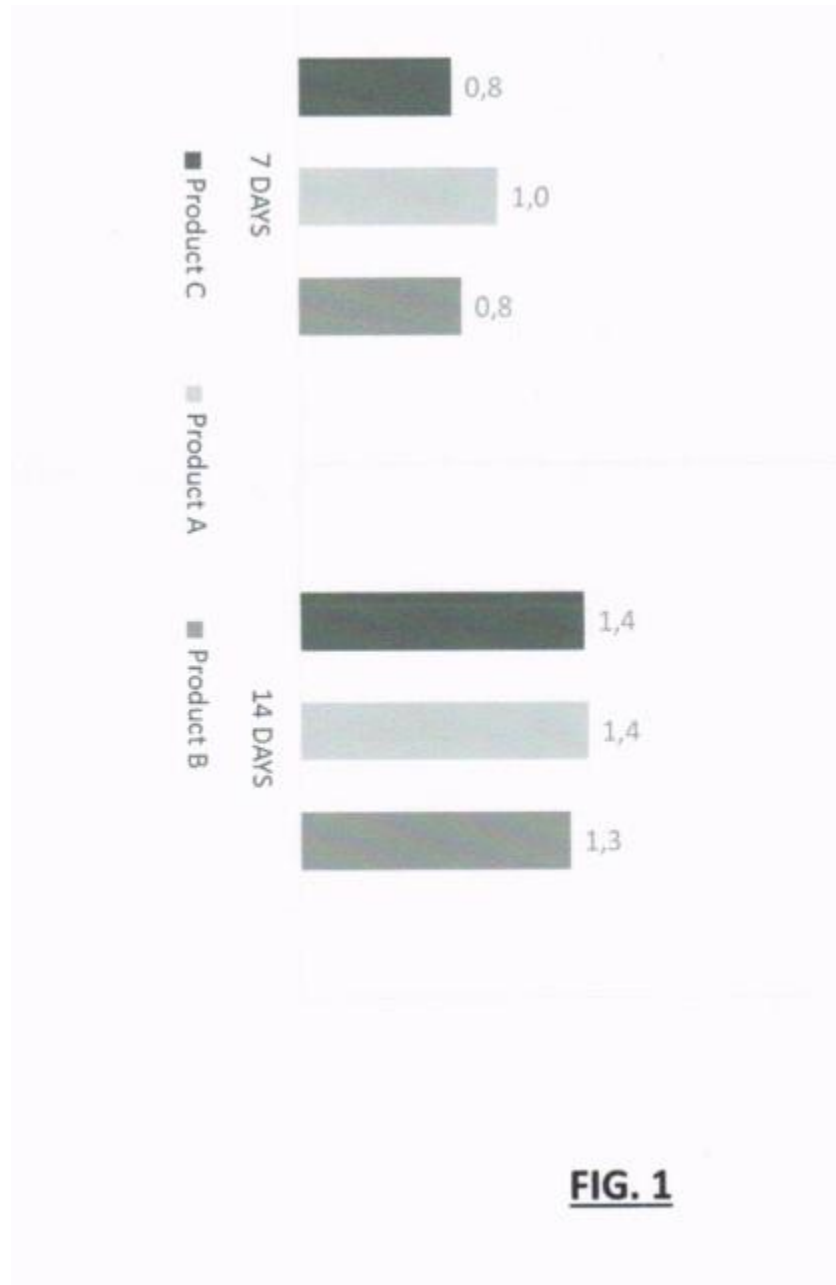

Figure 1

Official Gazette of Industrial Property Vol. 351, 10/04/2026

- (21) No. PT 969
- (22) 30/08/2024
- (30) 102022000003869 02/03/2022 IT
- (43)
- (51) Int.Cl.2018.01A 61K 8/23(2006.01), A 61K 8/44(2006.01), A 61K 8/67(2006.01), A 61Q 11/00(2006.01)
- (54) ຜະລິດຕະພັນການດູແລຊ່ອງປາກ
- (57) ສິ່ງປະດິດທີ່ນຳສະເໜີກ່ຽວຂ້ອງກັບການນຳໃຊ້ N-acetyl cysteine ເພື່ອເພີ່ມປະສິດທິພາບຂອງ alkali ຫຼື alkaline earth metal metabisulfite salts ແລະ ascorbic acid ໃນການຕ້ານການເກີດເມັດສີຢູ່ຜິ້ນຜິວຂອງແຂ້ວ, ເຍື່ອເມືອກໃນຊ່ອງປາກ, ຈຸດຜິ້ນຜູໃນຊ່ອງປາກ ຫຼື ຜະລິດຕະພັນແຂ້ວທຽມໃນຜູ້ປ່ວຍທີ່ປິ່ນປົວດ້ວຍ chlorhexidine, ແລະ ຜະລິດຕະພັນດູແລຊ່ອງປາກທີ່ປະກອບດ້ວຍ chlorhexidine, metabisulfite salt ຂອງ alkali ຫຼື alkaline earth metal ຢ່າງໜ້ອຍໜຶ່ງປະເພດ, ascorbic acid, ແລະ ; N-acetyl cysteine. .
- (71) CASTELLACCIO RJSTITUTA  
Via Trento, 34, 21047 Saronno, Italy (IT), Italy.
- (72) CASTELLACCIO RJSTITUTA.
- (74) KPN Intellectual Property Service Sole CO., Ltd.
- (55)



**FIG. 1**

# ພາກທີ I

## (Part I)

### ສິດທິບັດ ແລະ ອະນຸສິດທິບັດ (Patent and Petty Patent)

#### 2. ຜົນການອອກສິດທິບັດ ແລະ ອະນຸສິດທິບັດ (Grant of Patents and Petty Patents)

##### ຄຳອະທິບາຍກ່ຽວກັບລະຫັດຫຍໍ້

##### (Introduction of Codes)

- (11) ເລກທິ (Grant Number)
- (21) ເລກທິ ຄຳຮ້ອງ (Filing Number)
- (22) ວັນທິຍືນຄຳຮ້ອງ (Filing Date)
- (30) ວັນທິ ບຸລິມະສິດ (Priority Date)
- (43) ວັນທິເຜີຍແຜ່ (Publication Date)
- (51) ໝວດ (International Patent Classification)
- (54) ຫົວຂໍ້ການປະດິດ (Title)
- (57) ບົດຄັດຫຍໍ້ (Abstract)
- (71) ຊື່ ແລະ ທີ່ຢູ່ ເຈົ້າຂອງສິດທິບັດ ແລະ ອະນຸສິດທິບັດ (Owner Name and Address)
- (72) ຊື່ຜູ້ປະດິດ (Inventor Name)
- (74) ຊື່ຕົວແທນ (Representative Name)
- (55) ຮູບພາບ (Pictures)

**ພາກທີ I**

**(Part I)**

**ສິດທິບັດ ແລະ ອະນຸສິດທິບັດ  
(Patent and Petty Patent)**

**3. ການປ່ຽນແປງ  
(Changes)**

**ພາກທີ I**

**(Part I)**

**ສິດທິບັດ ແລະ ອະນຸສິດທິບັດ**  
**(Patent and Petty Patent)**

**4. ການດັດແກ້**

**(Amendments)**

**ພາກທີ II**  
**(Part II)**  
**ແບບອຸດສາຫະກຳ**  
**(Industrial Design)**

**1. ຄຳຮ້ອງ**  
**(Applications)**

**ຄຳອະທິບາຍກ່ຽວກັບລະຫັດຫຍໍ້**  
**(Introduction of Codes)**

- (21) ເລກທີ ຄຳຮ້ອງ (Filing Number)
- (22) ວັນທີ ຄຳຮ້ອງ (Filing Date)
- (30) ວັນທີ ບຸລິມາສິດ (Priority Date)
- (51) ໝວດ (Locarno Classification)
- (54) ຊື່ຂອງແບບອຸດສາຫະກຳ (Title)
- (71) ຊື່ ແລະ ທີ່ຢູ່ ຂອງເຈົ້າຂອງ (Owner Name and Address)
- (72) ຊື່ຜູ້ອອກແບບ (Designer Name)
- (74) ຊື່ຕົວແທນ (Representative Name)
- (55) ຮູບພາບ (Pictures)

**ພາກທີ II**  
**(Part II)**  
**ແບບອຸດສາຫະກຳ**  
**(Industrial Design)**

**2. ຜົນການຈົດທະບຽນ**  
**(Registration)**

**ຄຳອະທິບາຍກ່ຽວກັບລະຫັດຫຍໍ້**  
**(Introduction of Codes)**

- (11) ເລກທີ ຈົດທະບຽນ (Registration Number)
- (15) ວັນທີ ຈົດທະບຽນ (Registration Date)
- (21) ເລກທີ ຍືນຄຳຮ້ອງ (Filing Number)
- (22) ວັນທີ ຍືນຄຳຮ້ອງ (Filing Date)
- (30) ວັນທີ ບຸລິມາສິດ (Priority Date)
- (17) ວັນທີ ໝົດອາຍຸ (Expiration Date)
- (51) ໝວດ (Locarno Classification)
- (54) ຊື່ຂອງແບບອຸດສາຫະກຳ (Title)
- (71) ຊື່ ແລະ ທີ່ຢູ່ ຂອງເຈົ້າຂອງ (Owner Name and Address)
- (72) ຊື່ຜູ້ອອກແບບ (Designer Name)
- (74) ຊື່ຕົວແທນ (Representative Name)
- (55) ຮູບພາບ (Pictures)

**ພາກທີ II**  
**(Part II)**  
**ແບບອຸດສາຫະກຳ**  
**(Industrial Design)**

**3. ການປ່ຽນແປງ**  
**(Changes)**

**ພາກທີ II**  
**(Part II)**

**ແບບອຸດສາຫະກຳ**  
**(Industrial Design)**

**4. ການດັດແກ້**  
**(Amendments)**

**ພາກທີ III**  
**(Part III)**  
**ເຄື່ອງໝາຍການຄ້າ**  
**Trademarks**

**1. ຄໍາຮ້ອງ**  
**(Applications)**

**ຄໍາອະທິບາຍກ່ຽວກັບລະຫັດຫຍໍ້**  
**(Introduction of Codes)**

- (540) ເຄື່ອງໝາຍການຄ້າ (Trademark)
- (511) ໝວດ (Nice Classification)
- (210) ເລກທີ ຄໍາຮ້ອງ (Number of the application)
- (220) ວັນທີ ຄໍາຮ້ອງ (Date of filing of the application)
- (732) ຊື່ ແລະ ທີ່ຢູ່ ຂອງຜູ້ຍື່ນຄໍາຮ້ອງ (Name and Address of applicant)

## ພາກທີ III

### (Part III)

## ເຄື່ອງໝາຍການຄ້າ

### Trademarks

#### 2. ຜົນການຈົດທະບຽນ

##### (Registration)

##### ຄຳອະທິບາຍກ່ຽວກັບລະຫັດຫຍໍ້

##### (Introduction of Codes)

- (540) ເຄື່ອງໝາຍການຄ້າ (Trademark)
- (511) ໝວດ (Nice Classification)
- (210) ເລກທີ ຄຳຮ້ອງ (Number of the application)
- (220) ວັນທີ ຄຳຮ້ອງ (Date of filing of the application)
- (732) ຊື່ ແລະ ທີ່ຢູ່ ຂອງຜູ້ຍື່ນຄຳຮ້ອງ (Name and Address of applicant)
- (111) ເລກທີ ການຈົດທະບຽນເຄື່ອງໝາຍການຄ້າ (Number of the registration)
- (180) ວັນໝົດອາຍຸຂອງການຈົດທະບຽນ (Expiration date of the registration)

(540) Registration

**MISTINE**

(511) 35

(210) No. 52455

(220) 13/06/2025

(732) BETTER WAY (THAILAND) COMPANY  
LIMITED

210, Ramkhamhaeng Road, Rat Phatthana

Sub-district, Saphan Sung District, Bangkok

10240, Thailand

(111) No. 67397

(180) 13/06/2035

(540) Registration

**MISTINE**

(511) 03

(210) No. 52454

(220) 13/06/2025

(732) BETTER WAY (THAILAND) COMPANY  
LIMITED

210, Ramkhamhaeng Road, Rat Phatthana

Sub-district, Saphan Sung District, Bangkok

10240, Thailand

(111) No. 67398

(180) 13/06/2035

(540) Registration

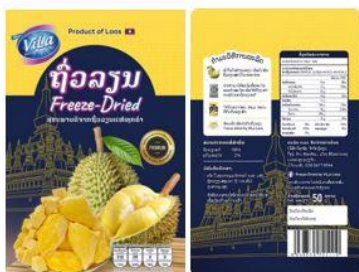

(511) 29

(210) No. 52451

(220) 12/06/2025

(732) ທ່ານ ນາງ ສີສຸພັນ ໄຊຍະສຸກ

ບ້ານ ຈັນສະຫວ່າງ, ເມືອງ ສີໂຄດຕະບອງ,

ນະຄອນຫຼວງວຽງຈັນ, ສປປ ລາວ

(111) No. 67399

(180) 12/06/2035

(540) Registration



(511) 29 and 32

(210) No. 52450

(220) 12/06/2025

(732) ທ່ານ ນາງ ສີສຸພັນ ໄຊຍະສຸກ

ບ້ານ ຈັນສະຫວ່າງ, ເມືອງ ສີໂຄດຕະບອງ,

ນະຄອນຫຼວງວຽງຈັນ, ສປປ ລາວ

(111) No. 67400

(180) 12/06/2035

(540) Registration

**MOVE**NET

(511) 42

(210) No. 52449

(220) 12/06/2025

(732) ZCHWANTECH SDN. BHD.

No. 8, Jalan SS21/37 Damansara Uptown  
47400, Petaling Jaya Selangor Darul Ehsan,  
Malaysia

(111) No. 67401

(180) 12/06/2035

(540) Registration

**MOVE**NET

(511) 36

(210) No. 52448

(220) 12/06/2025

(732) ZCHWANTECH SDN. BHD.

No. 8, Jalan SS21/37 Damansara Uptown  
47400, Petaling Jaya Selangor Darul Ehsan,  
Malaysia

(111) No. 67402

(180) 12/06/2035

(540) Registration

**MOVE**NET

(511) 35

(210) No. 52447

(220) 12/06/2025

(732) ZCHWANTECH SDN. BHD.

No. 8, Jalan SS21/37 Damansara Uptown  
47400, Petaling Jaya Selangor Darul Ehsan,  
Malaysia

(111) No. 67403

(180) 12/06/2035

(540) Registration

**ICAR**

(511) 12

(210) No. 52547

(220) 26/06/2025

(732) Chery New Energy Automobile Co., LTD

No.226 Huajin South Road, High-Tech  
Development Zone, Wuhu, Anhui Province,  
China

(111) No. 67404

(180) 26/06/2035

(540) Registration



(511) 11

(210) No. 52465

(220) 16/06/2025

(732) ບໍລິສັດ ໂກເນັງ ໂຮນດິງ ນິວ ເອັນເນີຈີ ກຣຸບ

ຈຳກັດຜູ້ດຽວ

ບ້ານ ດົງນາໂຊກເໜືອ, ເມືອງ ສີໂຄດຕະບອງ,

ນະຄອນຫຼວງວຽງຈັນ, ສປປ ລາວ

(111) No. 67405

(180) 16/06/2035

(540) Registration

**HELLORIDE**

(511) 42

(210) No. 52464

(220) 16/06/2025

(732) Shanghai Junfeng Network Technology

Co.,Ltd.

ROOM 01, 12TH FLOOR, UNIT 301, NO.1,

LANE 28, YUANXIU ROAD, MINHANG

DISTRICT, SHANGHAI, CHINA

(111) No. 67406

(180) 16/06/2035

(540) Registration

**HELLORIDE**

(511) 39

(210) No. 52463

(220) 16/06/2025

(732) Shanghai Junfeng Network Technology Co.,  
Ltd.

ROOM 01, 12TH FLOOR, UNIT 301, NO.1,  
LANE 28, YUANXIU ROAD, MINHANG  
DISTRICT, SHANGHAI, CHINA

(111) No. 67407

(180) 16/06/2035

(540) Registration

**HELLORIDE**

(511) 12

(210) No. 52462

(220) 16/06/2025

(732) Shanghai Junfeng Network Technology Co.,  
Ltd.

Room 01, 12th Floor, Unit 301, NO.1, Lane  
28, Yuanxiu Road,Minhang District,  
Shanghai, China

(111) No. 67408

(180) 16/06/2035

(540) Registration

**HELLORIDE**

(511) 09

(210) No. 52461

(220) 16/06/2025

(732) Shanghai Junfeng Network Technology Co.,  
Ltd.

ROOM 01, 12TH FLOOR, UNIT 301, NO.1,  
LANE 28, YUANXIU ROAD, MINHANG  
DISTRICT, SHANGHAI, CHINA

(111) No. 67409

(180) 16/06/2035

(540) Registration



(511) 03 and 05

(210) No. 52460

(220) 16/06/2025

(732) ບໍລິສັດ ລາວຕຸງເມິງການຢາ ແລະ ອາຫານ ຈຳກັດ  
ທາງ 13ໃຕ້, ບ້ານ ນາຜາສຸກ, ໜ່ວຍ1,  
ເມືອງ ໄຊທານີ, ນະຄອນຫຼວງວຽງຈັນ, ສປປ ລາວ

(111) No. 67410

(180) 16/06/2035

(540) Registration



(511) 29

(210) No. 52459

(220) 16/06/2025

(732) ວິສາຫະກິດສ່ວນບຸກຄົນ ໂຮງງານ ລູກຊີ້ນ ລາວ 5 ດີ  
ບ້ານ ດຸງ, ເມືອງ ໄຊເສດຖາ, ນະຄອນຫຼວງວຽງຈັນ,  
ສປປ ລາວ

(111) No. 67411

(180) 16/06/2035

(540) Registration

**ฮาคโก้**  
**HACO**

(511) 09

(210) No. 52458

(220) 13/06/2025

(732) HACO ELECTRIC (THAILAND) CO., LTD.  
18 Soi Ngamwongwan 9, Bang Khen  
Subdistrict, Mueang Nonthaburi District,  
Nonthaburi 11000, Thailand

(111) No. 67412

(180) 13/06/2035

(540) Registration

The logo for FREM, featuring the letters 'F', 'R', 'E', and 'M' in a bold, italicized, sans-serif font. The letters are white with a thick black outline and a slight 3D effect, set against a dark grey background.

(511) 12 and 17

(210) No. 52457

(220) 13/06/2025

(732) ASHUKA TECHNOLOGIES SDN BHD

998-999 Solok Perusahaan 3, Kawasan Miel,  
Prai Industrial Estate, 13600 Perai, Penang,  
Malaysia

(111) No. 67413

(180) 13/06/2035

(540) Registration

The logo for HP E, featuring the letters 'H', 'P', and 'E' in a bold, sans-serif font. The 'H' and 'P' are black, and the 'E' is green. The letters are white with a thick black outline.

(511) 09, 35, 36, 37, 38, 41 and 42

(210) No. 52474

(220) 17/06/2025

(732) HP Hewlett Packard Group LLC

10300 Energy Drive, Spring, Texas 77389,  
United States of America

(111) No. 67414

(180) 17/06/2035

(540) Registration

**Yibero**

(511) 05

(210) No. 52473

(220) 17/06/2025

(732) FUJIAN JIAYUE SANITARY PRODUCTS  
CO.,LTD

9FLOOR,3# SHENGRONG SQUARE,

FENGZE, QUANZHOU, FUJIAN, CHINA

(111) No. 67415

(180) 17/06/2035

(540) Registration



(511) 01, 02 and 19

(210) No. 52472

(220) 17/06/2025

(732) JORAKAY CORPORATION CO., LTD  
10 Krungthepkreetha Road, Thapchang,  
Saphansung, Bangkok 10250, Thailand

(111) No. 67416

(180) 17/06/2035

(540) Registration



(511) 01, 02 and 19

(210) No. 52471

(220) 17/06/2025

(732) JORAKAY CORPORATION CO., LTD

10 Krungthepkreetha Road, Thapchang,  
Saphansung, Bangkok 10250, Thailand

(111) No. 67417

(180) 17/06/2035

(540) Registration



(511) 01, 02 and 19

(210) No. 52470

(220) 17/06/2025

(732) JORAKAY CORPORATION CO., LTD

10 Krungthepkreetha Road, Thapchang,  
Saphansung, Bangkok 10250, Thailand

(111) No. 67418

(180) 17/06/2035

(540) Registration

**CELTO**

(511) 09

(210) No. 52467

(220) 16/06/2025

(732) NINGBO CELTO ELECTRONICS CO., LTD.

2rd Floor, Building A, No 562, Qishan Road,  
Hengxi Town, Yinzhou District, Ningbo City,  
Zhejiang Province, China

(111) No. 67419

(180) 16/06/2035

(540) Registration



(511) 30

(210) No. 52548

(220) 26/06/2025

(732) ວິສາຫະກິດ ສ່ວນບຸກຄົນ ເນັ່ງຢິງມິວ ປຸງແຕ່ງຊາຜູ້ສັ່ນ

ບ້ານ ຍວນ, ເມືອງ ແປກ, ແຂວງ ຊຽງຂວາງ,

ສປປ ລາວ

(111) No. 67420

(180) 26/06/2035

(540) Registration

**MIXXO**

(511) 18 and 25

(210) No. 52560

(220) 26/06/2025

(732) E.LAND WORLD LIMITED

159, Gasan digital 1-ro, Geumcheon-gu,  
Seoul, Republic of Korea

(111) No. 67421

(180) 26/06/2035

(540) Registration

**ROEM**

(511) 18 and 25

(210) No. 52561

(220) 26/06/2025

(732) E.LAND WORLD LIMITED

159, Gasan digital 1-ro, Geumcheon-gu,  
Seoul, Republic of Korea

(111) No. 67422

(180) 26/06/2035

(540) Registration

**Folder**

(511) 18 and 25

(210) No. 52562

(220) 26/06/2025

(732) E.LAND WORLD LIMITED

159, Gasan digital 1-ro, Geumcheon-gu,  
Seoul, Republic of Korea

(111) No. 67423

(180) 26/06/2035

(540) Registration



(511) 18 and 25

(210) No. 52559

(220) 26/06/2025

(732) E.LAND WORLD LIMITED

159, Gasan digital 1-ro, Geumcheon-gu,  
Seoul, Republic of Korea

(111) No. 67424

(180) 26/06/2035

(540) Registration

**HEMIX**

(511) 07

(210) No. 52553

(220) 26/06/2025

(732) Chen, Jiexiong

No. 206, Houqu Yongjin Road, Shanxi

Village, Xiangzhu Town, Yongkang City,

Zhejiang, China

(111) No. 67425

(180) 26/06/2035

(540) Registration

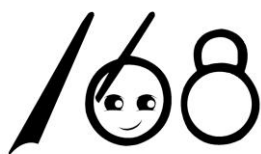

(511) 11

(210) No. 52554

(220) 26/06/2025

(732) Guangdong Meishan Electrical Co., Ltd.

No.10, Taixing North Road, Shengfeng

District, Xiaolan Town, Zhongshan City,

China

(111) No. 67426

(180) 26/06/2035

(540) Registration



(511) 03, 05 and 30

(210) No. 52555

(220) 26/06/2025

(732) Lixiang Hualai Technology Group Co., Ltd  
Kangping Avenue (Next to Pu'er North Toll  
Station), Simao District, Pu'er City, Yunnan  
Province, China

(111) No. 67427

(180) 26/06/2035

(540) Registration

**DAISO**

(511) 01, 02, 04, 06, 07, 08, 10, 11, 12, 15, 17, 19,  
22, 31 and 34

(210) No. 52556

(220) 26/06/2025

(732) Daiso Industries Co., Ltd.  
1-4-14 Yoshiyuki Higashi, Saijo,  
Higashihiroshima-city, Hiroshima 739-8501 ,  
Japan

(111) No. 67428

(180) 26/06/2035

(540) Registration

**MELANONX**

(511) 03

(210) No. 52557

(220) 26/06/2025

(732) SKINIDEA CO., LTD

2F, 726, Eonju-ro, Gangnam-gu, Seoul,  
Republic of Korea

(111) No. 67429

(180) 26/06/2035

(540) Registration

**SPA0**

(511) 18 and 25

(210) No. 52558

(220) 26/06/2025

(732) E.LAND WORLD LIMITED

159, Gasan digital 1-ro, Geumcheon-gu,  
Seoul, Republic of Korea

(111) No. 67430

(180) 26/06/2035

(540) Registration



(511) 35

(210) No. 52563

(220) 27/06/2025

(732) Lotus Mattress Co., Ltd.

298/49 Pitsanulok Road, Kwang

Siyakmahanak, Khet Dusit, Bangkok, 10300,

Thailand

(111) No. 67433

(180) 27/06/2035

(540) Registration



(511) 12

(210) No. 52551

(220) 26/06/2025

(732) HAN HONGWEI

No. 114 Wanglou Village, Zhailou

Administrative Village, Tiangongmiao Town,

Chengwu County, Shandong Province, China

(111) No. 67434

(180) 26/06/2035

(540) Registration



(511) 43

(210) No. 52564

(220) 27/06/2025

(732) ທ່ານ ສິນດາມອນ ສອນພັນ

ບ້ານ ໂພນປ່າເປົ້າ, ເມືອງ ສີສັດຕະນາກ,

ນະຄອນຫຼວງວຽງຈັນ, ສປປ ລາວ

(111) No. 67435

(180) 27/06/2035

(540) Registration



(511) 14 and 40

(210) No. 52549

(220) 26/06/2025

(732) ບໍລິສັດ ໂຮງງານກັ່ນຫຼອມ ວັດຖຸມີຄ່າ ລາວ-ສາກົນ

ຈຳກັດ

ບ້ານ ຊຽງດາ, ເມືອງ ໄຊເສດຖາ,

ນະຄອນຫຼວງວຽງຈັນ, ສປປ ລາວ

(111) No. 67436

(180) 26/06/2035

(540) Registration



(511) 09

(210) No. 52550

(220) 26/06/2025

(732) ທະນາຄານຄຳ ລາວ ຈຳກັດ

ສຳນັກງານໃຫຍ່ ທະນາຄານຄຳ ລາວ ຈຳກັດ,

ບ້ານ ໂພນໂຊ, ເມືອງ ໄຊເສດຖາ,

ນະຄອນຫຼວງວຽງຈັນ, ສປປ ລາວ

(111) No. 67437

(180) 26/06/2035

(540) Registration

*Pompeii*  
— ດອມເປີ —

(511) 43

(210) No. 52424

(220) 06/06/2025

(732) ທ່ານ ນາງ ສຸພະຕາ ຂຶ້ນພິມມະວິງ

ບ້ານ ສິມຫວັງ, ເມືອງ ຫາດຊາຍຝອງ,

ນະຄອນຫຼວງວຽງຈັນ, ສປປ ລາວ

(111) No. 67438

(180) 06/06/2035

(540) Registration



(511) 30

(210) No. 52401

(220) 02/06/2025

(732) ໂຮງງານ ຜະລິດກະແລ້ມກາໜາກແອັບເປີນ ສ່ວນບຸກຄົນ  
ບ້ານ ນາເມືອງ, ເມືອງ ທ່າແຂກ, ແຂວງ ຄຳມ່ວນ,  
ສປປ ລາວ

(111) No. 67439

(180) 02/06/2035

(540) Registration



(511) 33

(210) No. 52398

(220) 02/06/2025

(732) ກຸ່ມຕົ້ມເຫຼົ້າຂາວນ້ຳກະບໍ່

ບ້ານ ນ້ຳກະບໍ່, ເມືອງ ໄຊບົວທອງ, ແຂວງ ຄຳມ່ວນ,  
ສປປ ລາວ

(111) No. 67440

(180) 02/06/2035

(540) Registration



(511) 22, 25 and 26

(210) No. 52406

(220) 03/06/2025

(732) ວິສາຫະກິດສ່ວນບຸກຄົນ ເຮືອນຫຼັກ ກິມຫມຸ

ບ້ານ ໂພນໄຊ, ເມືອງ ໄຊເສດຖາ,

ນະຄອນຫຼວງວຽງຈັນ, ສປປ ລາວ

(111) No. 67481

(180) 03/06/2035

(540) Registration



(511) 36

(210) No. 52432

(220) 09/06/2025

(732) ບໍລິສັດ ລາວຝາຍແນນໂຊ່ ເຕັກໂນໂລຊີ ຈຳກັດ

ບ້ານ ໂພນທັນ, ເມືອງ ໄຊເສດຖາ,

ນະຄອນຫຼວງວຽງຈັນ, ສປປ ລາວ

(111) No. 67482

(180) 09/06/2035

(540) Registration



(511) 43

(210) No. 52423

(220) 06/06/2025

(732) ທ່ານ ນາງ ສຸພະຕາ ຂຶ້ນພິມມະວິງ  
ບ້ານ ສິມຫວັງ, ເມືອງ ຫາດຊາຍຝອງ,  
ນະຄອນຫຼວງວຽງຈັນ, ສປປ ລາວ

(111) No. 67483

(180) 06/06/2035

(540) Registration



(511) 29

(210) No. 52410

(220) 04/06/2025

(732) ວິສາຫະກິດສ່ວນບຸກຄົນ ເຂົ້າຊອຍ ແມ່ສຸກ  
ບ້ານ ສະພານທອງໃຕ້, ເມືອງ ສີສັດຕະນາກ,  
ນະຄອນຫຼວງວຽງຈັນ, ສປປ ລາວ

(111) No. 67484

(180) 04/06/2035

(540) Registration



(511) 30

(210) No. 52409

(220) 04/06/2025

(732) ບໍລິສັດ ຜະລິດຕະພັນອາຫານຮຸ່ງເຮືອງວຽງຈັນ

ຈຳກັດຜູ້ດຽວ

ບ້ານ ດົງຊຽງດີ, ເມືອງ ນາຊາຍທອງ,

ນະຄອນຫຼວງວຽງຈັນ, ສປປ ລາວ

(111) No. 67485

(180) 04/06/2035

**ພາກທີ III**  
**(Part III)**  
**ເຄື່ອງໝາຍການຄ້າ**  
**Trademarks**

**3. ການຕໍ່ອາຍຸ**  
**(Renewal)**

**ຄຳອະທິບາຍກ່ຽວກັບລະຫັດຫຍໍ້**  
**(Introduction of Codes)**

- (540) ເຄື່ອງໝາຍການຄ້າ (Trademark)
- (511) ໝວດ (Nice Classification)
- (210) ເລກທີ ຄຳຮ້ອງ (Number of the application)
- (220) ວັນທີ ຄຳຮ້ອງ (Date of filing of the application)
- (732) ຊື່ ແລະ ທີ່ຢູ່ ຂອງຜູ້ຍື່ນຄຳຮ້ອງ (Name and Address of applicant)
- (111) ເລກທີການຈັດທະບຽນເຄື່ອງໝາຍການຄ້າ (Number of the registration)
- (180) ການຕໍ່ອາຍຸການຈັດທະບຽນ (Expiration date of the renewal)

(540) Trademark Renewal

**BARTON & GUESTIER**

(511) 33

(210) No. 3627

(220) 17/03/1995

(732) Barton & Guestier S.A.S

87 rue du Dehez, Chateau Magnol, 33290

Blanquefort, France

(111) No. 3169

(180) 17/03/2035

(540) Trademark Renewal

**ucc**

(511) 30

(210) No. 3679

(220) 19/04/1995

(732) UCC Capital Co., Ltd.

6-go, 1-ban, 5-chome, Tamondori, Chuo-ku,

Kobe-shi, Hyogo-ken, Japan

(111) No. 3260

(180) 19/04/2035

(540) Trademark Renewal



(511) 32

(210) No. 3680

(220) 19/04/1995

(732) UCC Capital Co., Ltd.

6-go, 1-ban, 5-chome, Tamondori, Chuo-ku,  
Kobe-shi, Hyogo-ken, Japan

(111) No. 3261

(180) 19/04/2035

(540) Trademark Renewal

**UCC**

(511) 42

(210) No. 3681

(220) 19/04/1995

(732) UCC Capital Co., Ltd.

6-go, 1-ban, 5-chome, Tamondori, Chuo-ku,  
Kobe-shi, Hyogo-ken, Japan

(111) No. 3262

(180) 19/04/2035

(540) Trademark Renewal



(511) 09

(210) No. 3759

(220) 16/05/1995

(732) ROLEX SA

3-5-7 rue Francols-Dussaud, Geneva,  
Switzerland

(111) No. 3471

(180) 16/05/2035

(540) Trademark Renewal



(511) 16

(210) No. 3760

(220) 17/05/1995

(732) ROLEX SA.

3-5-7 rue François-Dussaud, Geneva,  
Switzerland

(111) No. 3472

(180) 17/05/2035

(540) Trademark Renewal



(511) 41

(210) No. 3761

(220) 17/05/1995

(732) ROLEX SA.

3-5-7 rue François-Dussaud, Geneva,  
Switzerland

(111) No. 3473

(180) 17/05/2035

(540) Trademark Renewal



(511) 42

(210) No. 3762

(220) 17/05/1995

(732) ROLEX SA

3-5-7 rue Francols-Dussaud, Geneva,  
Switzerland

(111) No. 3474

(180) 17/05/2035

(540) Trademark Renewal

**RED HORSE**

(511) 32

(210) No. 3819

(220) 12/06/1995

(732) San Miguel Brewing International Limited.

Commerce House, Wickhams Cay 1, P.O.

Box 3140, Road Town, Tortola, Virgin

Islands, British c/o 9/F Citimark Building 28

Yuen Shun Circuit, Siu Lek, Yuen Shatin

N.T., Hong Kong

(111) No. 3657

(180) 12/06/2035

(540) Trademark Renewal

**GOLD EAGLE**

(511) 32

(210) No. 3820

(220) 12/06/1995

(732) San Miguel Brewing International Limited.

Commerce House, Wickhams Cay 1, P.O.

Box 3140, Road Town, Tortola, Virgin

Islands, British c/o 9/F Citimark Building 28

Yuen Shun Circuit, Siu Lek, Yuen Shatin

N.T., Hong Kong

(111) No. 3658

(180) 12/06/2035

(540) Trademark Renewal

**SAN MIGUEL SUPER  
DRY**

(511) 32

(210) No. 3823

(220) 12/06/1995

(732) San Miguel Brewing International Limited.

Commerce House, Wickhams Cay 1, P.O.

Box 3140, Road Town, Tortola, Virgin

Islands, British c/o 9/F Citimark Building 28

Yuen Shun Circuit, Siu Lek, Yuen Shatin

N.T., Hong Kong

(111) No. 3661

(180) 12/06/2035

(540) Trademark Renewal



(511) 32

(210) No. 3826

(220) 12/06/1995

(732) San Miguel Brewing International Limited.

Commerce House, Wickhams Cay 1, P.O.

Box 3140, Road Town, Tortola, Virgin

Islands, British c/o 9/F Citimark Building 28

Yuen Shun Circuit, Siu Lek, Yuen Shatin

N.T., Hong Kong

(111) No. 3664

(180) 12/06/2035

(540) Trademark Renewal



(511) 32

(210) No. 3828

(220) 12/06/1995

(732) San Miguel Brewing International Limited.

Commerce House, Wickhams Cay 1, P.O.

Box 3140, Road Town, Tortola, Virgin

Islands, British c/o 9/F Citimark Building 28

Yuen Shun Circuit, Siu Lek, Yuen Shatin

N.T., Hong Kong

(111) No. 3666

(180) 12/06/2035

(540) Trademark Renewal

**GLUCOPHAGE**

(511) 05

(210) No. 3735

(220) 05/05/1995

(732) MERCK SANTÉ S.A.S.

37 rue Saint Romain, 69008 Lyon, France

(111) No. 3873

(180) 05/05/2035

(540) Trademark Renewal

**VOGUE**

(511) 16

(210) No. 3736

(220) 05/05/1995

(732) Advance Magazine Publishers, Inc.

One World Trade Center, New York, NY

10007, United States of America

(111) No. 3874

(180) 05/05/2035

(540) Trademark Renewal

มามา

(511) 30

(210) No. 4019

(220) 06/09/1995

(732) Thai President Foods Public Company

Limited

304 Srinakarin Road, Huamark Sub-district,

Bangkapi District, Bangkok 10240, Thailand

(111) No. 3977

(180) 06/09/2035

(540) Trademark Renewal



(511) 42

(210) No. 3912

(220) 21/07/1995

(732) SUPER 8 WORLDWIDE, INC.

22 Sylvan Way, Parsippany, New Jersey

07054, United States of America

(111) No. 4122

(180) 21/07/2035

(540) Trademark Renewal

**GOODYEAR**

(511) 01

(210) No. 12565

(220) 12/05/1995

(732) The Goodyear Tire & Rubber Company.

200 Innovation Way, Akron, Ohio 44316-

0001, United States of America

(111) No. 11987

(180) 12/05/2035

(540) Trademark Renewal

**GOODYEAR**

(511) 07

(210) No. 12566

(220) 12/05/1995

(732) The Goodyear Tire & Rubber Company

200 Innovation Way, Akron, Ohio

44316-0001, United States of America

(111) No. 11988

(180) 12/05/2035

(540) Trademark Renewal

**GOODYEAR**

(511) 12

(210) No. 12567

(220) 12/05/1995

(732) The Goodyear Tire & Rubber Company.

200 Innovation Way, Akron, Ohio 44316-

0001, United States of America

(111) No. 11989

(180) 12/05/2035

(540) Trademark Renewal

**GOODYEAR**

(511) 16

(210) No. 12568

(220) 12/05/1995

(732) The Goodyear Tire & Rubber Company.

200 Innovation Way, Akron, Ohio 44316-  
0001, United States of America

(111) No. 11990

(180) 12/05/2035

(540) Trademark Renewal

**GOODYEAR**

(511) 17

(210) No. 12569

(220) 24/03/2005

(732) The Goodyear Tire & Rubber Company.

200 Innovation Way, Akron, Ohio 44316-  
0001, United States of America

(111) No. 11991

(180) 12/05/2035

(540) Trademark Renewal

**GOODYEAR**

(511) 25

(210) No. 12570

(220) 12/05/1995

(732) The Goodyear Tire & Rubber Company.

200 Innovation Way, Akron, Ohio 44316-  
0001, United States of America

(111) No. 11992

(180) 12/05/2035

(540) Trademark Renewal

**GOODYEAR**

(511) 28

(210) No. 12571

(220) 12/05/1995

(732) The Goodyear Tire & Rubber Company.

200 Innovation Way, Akron, Ohio 44316-  
0001, United States of America

(111) No. 11993

(180) 12/05/2035

(540) Trademark Renewal



(511) 01

(210) No. 12572

(220) 12/05/1995

(732) The Goodyear Tire & Rubber Company  
200 Innovation Way, Akron, Ohio 44316-  
0001, United States of America

(111) No. 11994

(180) 12/05/2035

(540) Trademark Renewal



(511) 07

(210) No. 12573

(220) 12/05/1995

(732) The Goodyear Tire & Rubber Company.  
200 Innovation Way, Akron, Ohio 44316-  
0001, United States of America

(111) No. 11995

(180) 12/05/2035

(540) Trademark Renewal



(511) 12

(210) No. 12574

(220) 12/05/1995

(732) The Goodyear Tire & Rubber Company.  
200 Innovation Way, Akron, Ohio 44316-  
0001, United States of America

(111) No. 11996

(180) 12/05/2035

(540) Trademark Renewal



(511) 17

(210) No. 12576

(220) 12/05/1995

(732) The Goodyear Tire & Rubber Company.  
200 Innovation Way, Akron, Ohio 44316-  
0001, United States of America

(111) No. 11998

(180) 12/05/2035

(540) Trademark Renewal



(511) 25

(210) No. 12577

(220) 12/05/1995

(732) The Goodyear Tire & Rubber Company.  
200 Innovation Way, Akron, Ohio 44316-  
0001, United States of America

(111) No. 11999

(180) 12/05/2035

(540) Trademark Renewal



(511) 28

(210) No. 12578

(220) 12/05/1995

(732) The Goodyear Tire & Rubber Company.  
200 Innovation Way, Akron, Ohio 44316-  
0001, United States of America

(111) No. 12000

(180) 12/05/2035

(540) Trademark Renewal

The logo for Canon, featuring the word "Canon" in a bold, black, sans-serif font.

(511) 01

(210) No. 12605

(220) 05/05/1995

(732) CANON KABUSHIKI KAISHA

30-2, Shimomaruko 3-chome, Ohta-ku,

Tokyo, Japan

(111) No. 12007

(180) 05/05/2035

(540) Trademark Renewal

The logo for Canon, featuring the word "Canon" in a bold, black, sans-serif font.

(511) 02

(210) No. 12606

(220) 05/05/1995

(732) CANON KABUSHIKI KAISHA

30-2, Shimomaruko 3-chome, Ohta-ku,

Tokyo, Japan

(111) No. 12008

(180) 05/05/2035

(540) Trademark Renewal

The logo for Canon, featuring the word "Canon" in a bold, black, sans-serif font.

(511) 07

(210) No. 12607

(220) 05/05/1995

(732) CANON KABUSHIKI KAISHA

30-2, Shimomaruko 3-chome, Ohta-ku,

Tokyo, Japan

(111) No. 12009

(180) 05/05/2035

(540) Trademark Renewal

The logo for Canon, featuring the word "Canon" in a bold, black, sans-serif font.

(511) 08

(210) No. 12608

(220) 05/05/1995

(732) CANON KABUSHIKI KAISHA

30-2, Shimomaruko 3-chome, Ohta-ku,

Tokyo, Japan

(111) No. 12010

(180) 05/05/2035

(540) Trademark Renewal

The logo for Canon, featuring the word "Canon" in a bold, black, sans-serif font.

(511) 09

(210) No. 12609

(220) 05/05/1995

(732) CANON KABUSHIKI KAISHA

30-2, Shimomaruko 3-chome, Ohta-ku,

Tokyo, Japan

(111) No. 12011

(180) 05/05/2035

(540) Trademark Renewal

The logo for Canon, featuring the word "Canon" in a bold, black, sans-serif font.

(511) 10

(210) No. 12610

(220) 05/05/1995

(732) CANON KABUSHIKI KAISHA

30-2, Shimomaruko 3-chome, Ohta-ku,

Tokyo, Japan

(111) No. 12012

(180) 05/05/2035

(540) Trademark Renewal

The logo for Canon, featuring the word "Canon" in a bold, black, sans-serif font.

(511) 14

(210) No. 12611

(220) 05/05/1995

(732) CANON KABUSHIKI KAISHA

30-2, Shimomaruko 3-chome, Ohta-ku,

Tokyo, Japan

(111) No. 12013

(180) 05/05/2035

(540) Trademark Renewal

The logo for Canon, featuring the word "Canon" in a bold, black, sans-serif font.

(511) 16

(210) No. 12612

(220) 05/05/1995

(732) CANON KABUSHIKI KAISHA

30-2, Shimomaruko 3-chome, Ohta-ku,

Tokyo, Japan

(111) No. 12014

(180) 05/05/2035

(540) Trademark Renewal

**Canon**

(511) 25

(210) No. 12613

(220) 05/05/1995

(732) CANON KABUSHIKI KAISHA

30-2, Shimomaruko 3-chome, Ohta-ku,

Tokyo, Japan

(111) No. 12015

(180) 05/05/2035

(540) Trademark Renewal

**TWENTIETH  
CENTURY FOX**

(511) 09

(210) No. 12722

(220) 20/07/1995

(732) Fox Media LLC

10201 West Pico Boulevard, Los Angeles,

CA 90035, United States of America

(111) No. 12046

(180) 20/07/2035

(540) Trademark Renewal

**TWENTIETH  
CENTURY FOX**

(511) 41

(210) No. 12723

(220) 20/07/1995

(732) Fox Media LLC

10201 West Pico Boulevard, Los Angeles,  
CA 90035, United States of America

(111) No. 12047

(180) 20/07/2035

(540) Trademark Renewal



(511) 09

(210) No. 12724

(220) 20/07/1995

(732) Fox Media LLC

10201 West Pico Boulevard, Los Angeles,  
CA 90035, United States of America

(111) No. 12048

(180) 20/07/2035

(540) Trademark Renewal



(511) 41

(210) No. 12725

(220) 20/07/1995

(732) Fox Media LLC

10201 West Pico Boulevard, Los Angeles,  
CA 90035, United States of America

(111) No. 12049

(180) 20/07/2035

(540) Trademark Renewal

roberto cavalli  
serpentine

(511) 03

(210) No. 12743

(220) 13/05/2005

(732) HELIER FASHION FZE

Office No. LB15224, Jebel Ali Free Zone,  
Dubai, United Arab Emirates

(111) No. 12246

(180) 13/05/2035

(540) Trademark Renewal



(511) 34

(210) No. 12780

(220) 25/05/2005

(732) CTBAT International Co. Limited.

29th Floor, Oxford House, Taikoo Place, 979

King's Road, Island East, Hong Kong

(111) No. 12279

(180) 25/05/2035

(540) Trademark Renewal



(511) 07

(210) No. 12861

(220) 19/06/1995

(732) Scania CV Aktiebolag.

S-151 87 Södertälje, Sweden

(111) No. 12315

(180) 19/06/2035

(540) Trademark Renewal



(511) 12

(210) No. 12862

(220) 19/06/1995

(732) Scania CV Aktiebolag.

S-151 87 Södertälje, Sweden

(111) No. 12316

(180) 19/06/2035

(540) Trademark Renewal



(511) 07

(210) No. 12831

(220) 13/06/2005

(732) Scania CV Aktiebolag.

S-151 87 Södertälje, Sweden

(111) No. 12375

(180) 13/06/2035

(540) Trademark Renewal



(511) 12

(210) No. 12832

(220) 13/06/2005

(732) Scania CV Aktiebolag.

S-151 87 Södertälje, Sweden

(111) No. 12376

(180) 13/06/2035

(540) Trademark Renewal

**GLAXO  
WELLCOME**

(511) 05

(210) No. 13226

(220) 23/05/1995

(732) Glaxo Group Limited

GSK Medicines Research Centre, Gunnels

Wood Road, Stevenage, SG1 2NY,

United Kingdom

(111) No. 12486

(180) 23/05/2035

(540) Trademark Renewal

**ROLEX DEEPSEA**

(511) 14

(210) No. 13013

(220) 25/07/2005

(732) ROLEX SA.

3-5-7 rue François-Dussaud, Geneva,  
Switzerland

(111) No. 12582

(180) 25/07/2035

(540) Trademark Renewal

**ROLEX PRINCE**

(511) 14

(210) No. 13014

(220) 25/07/2005

(732) ROLEX SA.

3-5-7 rue François-Dussaud, Geneva,  
Switzerland

(111) No. 12583

(180) 25/07/2035

(540) Trademark Renewal



(511) 12

(210) No. 13101

(220) 12/08/2005

(732) HWA FONG RUBBER IND. CO., LTD.

No. 300, Chung Shan Road, Sec. 2, Ta Tsun  
Hsiang, Changhua Hsien, Taiwan, R.O.C,  
Taiwan

(111) No. 12651

(180) 12/08/2035

(540) Trademark Renewal

**FINAL FANTASY**

(511) 09

(210) No. 13102

(220) 15/08/2005

(732) KABUSHIKI KAISHA SQUARE ENIX

HOLDINGS (also trading as Square Enix  
Holdings Co., Ltd.)

6-27-30 Shinjuku, Shinjuku-ku, Tokyo,  
Japan

(111) No. 12653

(180) 15/08/2035

(540) Trademark Renewal

**GMAIL**

(511) 38

(210) No. 13220

(220) 14/09/2005

(732) GOOGLE LLC

1600 Amphitheatre Parkway, Mountain View,  
CA 94043, United States of America

(111) No. 12886

(180) 14/09/2035

(540) Trademark Renewal



(511) 43

(210) No. 13329

(220) 29/09/2005

(732) T.C. Pharmaceutical Industries Co., Ltd.

288 Ekachai Road, Khlong Bang Phran Sub-  
District, Bangbon District, Bangkok 10150,  
Thailand

(111) No. 12947

(180) 29/09/2035

(540) Trademark Renewal



(511) 29

(210) No. 13330

(220) 29/09/2005

(732) T.C. Pharmaceutical Industries Co., Ltd.

288 Ekachai Road, Khlong Bang Phran Sub-District, Bangbon District, Bangkok 10150, Thailand

(111) No. 12948

(180) 29/09/2035

(540) Trademark Renewal



(511) 30

(210) No. 13331

(220) 29/09/2005

(732) T.C. Pharmaceutical Industries Co., Ltd.

288 Ekachai Road, Khlong Bang Phran Sub-District, Bangbon District, Bangkok 10150, Thailand

(111) No. 12949

(180) 29/09/2035

(540) Trademark Renewal



(511) 31

(210) No. 13332

(220) 29/09/2005

(732) T.C. Pharmaceutical Industries Co., Ltd.

288 Ekachai Road, Khlong Bang Phran Sub-District, Bangbon District, Bangkok 10150, Thailand

(111) No. 12950

(180) 29/09/2035

(540) Trademark Renewal



(511) 33

(210) No. 13333

(220) 29/09/2005

(732) T.C. Pharmaceutical Industries Co., Ltd.

288 Ekachai Road, Khlong Bang Phran Sub-District, Bangbon District, Bangkok 10150, Thailand

(111) No. 12951

(180) 29/09/2035

(540) Trademark Renewal



(511) 29

(210) No. 13336

(220) 29/09/2005

(732) T.C. Pharmaceutical Industries Co., Ltd.

288 Ekachai Road, Khlong Bang Phran Sub-District, Bangbon District, Bangkok 10150, Thailand

(111) No. 12954

(180) 29/09/2035

(540) Trademark Renewal



(511) 30

(210) No. 13337

(220) 29/09/2005

(732) T.C. Pharmaceutical Industries Co., Ltd.

288 Ekachai Road, Khlong Bang Phran Sub-District, Bangbon District, Bangkok 10150, Thailand

(111) No. 12955

(180) 29/09/2035

(540) Trademark Renewal



(511) 31

(210) No. 13338

(220) 29/09/2005

(732) T.C. Pharmaceutical Industries Co., Ltd.

288 Ekachai Road, Khlong Bang Phran Sub-District, Bangbon District, Bangkok 10150, Thailand

(111) No. 12956

(180) 29/09/2035

(540) Trademark Renewal

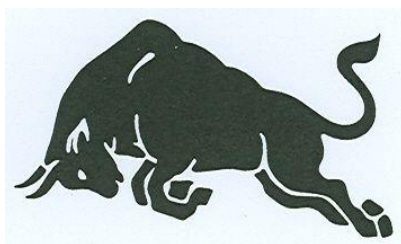

(511) 33

(210) No. 13339

(220) 29/09/2005

(732) T.C. Pharmaceutical Industries Co., Ltd.

288 Ekachai Road, Khlong Bang Phran Sub-District, Bangbon District, Bangkok 10150, Thailand

(111) No. 12957

(180) 29/09/2035

(540) Trademark Renewal



(511) 35

(210) No. 13340

(220) 29/09/2005

(732) T.C. Pharmaceutical Industries Co., Ltd.

288 Ekachai Road, Khlong Bang Phran Sub-District, Bangbon District, Bangkok 10150, Thailand

(111) No. 12958

(180) 29/09/2035

(540) Trademark Renewal

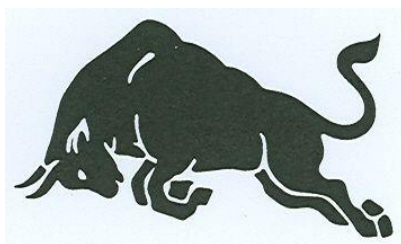

(511) 43

(210) No. 13341

(220) 29/09/2005

(732) T.C. Pharmaceutical Industries Co., Ltd.

288 Ekachai Road, Khlong Bang Phran Sub-District, Bangbon District, Bangkok 10150, Thailand

(111) No. 12959

(180) 29/09/2035

(540) Trademark Renewal

**PREVIA**

(511) 12

(210) No. 13356

(220) 06/10/2005

(732) TOYOTA JIDOSHA KABUSHIKI KAISHA

(also trading as Toyota Motor Corporation)

1, Toyota-cho, Toyota-shi, Aichi-ken, Japan

(111) No. 12980

(180) 06/10/2035

(540) Trademark Renewal

**TOYOTA RAV 4**

(511) 12

(210) No. 13357

(220) 06/10/2005

(732) TOYOTA JIDOSHA KABUSHIKI KAISHA

(also trading as Toyota Motor Corporation)

1, Toyota-cho, Toyota-shi, Aichi-ken, Japan

(111) No. 12981

(180) 06/10/2035

(540) Trademark Renewal

**HILUX VIGO**

(511) 12

(210) No. 13358

(220) 06/10/2005

(732) TOYOTA JIDOSHA KABUSHIKI KAISHA

(also trading as Toyota Motor Corporation)

1, Toyota-cho, Toyota-shi, Aichi-ken, Japan

(111) No. 12982

(180) 06/10/2035

(540) Trademark Renewal

**TAMIFLU**

(511) 05

(210) No. 13561

(220) 28/10/2005

(732) F. Hoffmann-La Roche AG

Grenzacherstrasse 124, 4002 Basel,

Switzerland

(111) No. 13094

(180) 28/10/2035

(540) Trademark Renewal

**anitech**

(511) 09

(210) No. 29694

(220) 17/07/2013

(732) SMART ID GROUP CO., LTD.

1, Soi Rattanathibeth 17/1, BangKrasor Sub-District, Meuang Nonthaburi District, Nonthaburi 11000, Thailand

(111) No. 29460

(180) 01/12/2034

(540) Trademark Renewal



(511) 01

(210) No. 30032

(220) 15/08/2013

(732) CHONGQING CHUANDONG

CHEMICAL(GROUP) CO., LTD

No.70 Danzishi New Street, Danzishi Street, Nan'an District, Chongqing City, China

(111) No. 29788

(180) 04/12/2034

(540) Trademark Renewal

**SKYTEAM**

(511) 39

(210) No. 31405

(220) 05/02/2014

(732) Guardant, Inc

1030 Delta Boulevard, Atlanta, Georgia,  
United States of America

(111) No. 31204

(180) 27/03/2035

(540) Trademark Renewal

**CIPLA**

(511) 03

(210) No. 31520

(220) 21/02/2014

(732) CIPLA LIMITED

Cipla House, Peninsula Business Park,  
Ganpatrao Kadam Marg, Lower Parel,  
Mumbai - 400013, Maharashtra, India

(111) No. 31315

(180) 26/03/2035

(540) Trademark Renewal

**CIPLA**

(511) 05

(210) No. 31521

(220) 21/02/2014

(732) CIPLA LIMITED

Cipla House, Peninsula Business Park,  
Ganpatrao Kadam Marg, Lower Parel,  
Mumbai - 400013, Maharashtra, India

(111) No. 31316

(180) 26/03/2035

(540) Trademark Renewal

**CIPLA**

(511) 09

(210) No. 31522

(220) 21/02/2014

(732) CIPLA LIMITED

Cipla House, Peninsula Business Park,  
Ganpatrao Kadam Marg, Lower Parel,  
Mumbai - 400013, Maharashtra, India

(111) No. 31317

(180) 26/03/2035

(540) Trademark Renewal

**CIPLA**

(511) 10

(210) No. 31523

(220) 21/02/2014

(732) CIPLA LIMITED

Cipla House, Peninsula Business Park,  
Ganpatrao Kadam Marg, Lower Parel,  
Mumbai - 400013, Maharashtra, India

(111) No. 31318

(180) 26/03/2035

(540) Trademark Renewal

**CIPLA**

(511) 35

(210) No. 31524

(220) 21/02/2014

(732) CIPLA LIMITED

Cipla House, Peninsula Business Park,  
Ganpatrao Kadam Marg, Lower Parel,  
Mumbai - 400013, Maharashtra, India

(111) No. 31319

(180) 26/03/2035

(540) Trademark Renewal

**CIPLA**

(511) 44

(210) No. 31525

(220) 21/02/2014

(732) CIPLA LIMITED

Cipla House, Peninsula Business Park,  
Ganpatrao Kadam Marg, Lower Parel,  
Mumbai - 400013, Maharashtra, India

(111) No. 31320

(180) 26/03/2035

(540) Trademark Renewal

**BULLEIT**

(511) 33

(210) No. 31611

(220) 11/03/2014

(732) Diageo North America, Inc

Three World Trade Center 175 Greenwich  
Street New York 10007,  
United States of America

(111) No. 31894

(180) 05/04/2035

(540) Trademark Renewal

**Kaeser**

(511) 04

(210) No. 31652

(220) 18/03/2014

(732) Kaeser Kompressoren SE

Carl-Kaeser-Str. 26, 96450 Coburg,

Germany

(111) No. 31928

(180) 05/04/2035

(540) Trademark Renewal

**Kaeser**

(511) 06

(210) No. 31653

(220) 18/03/2014

(732) Kaeser Kompressoren SE

Carl-Kaeser-Str. 26, 96450 Coburg,

Germany

(111) No. 31929

(180) 05/04/2035

(540) Trademark Renewal

**Kaesar**

(511) 07

(210) No. 31654

(220) 18/03/2014

(732) Kaeser Kompressoren SE

Carl-Kaeser-Str. 26, 96450 Coburg,

Germany

(111) No. 31930

(180) 05/04/2035

(540) Trademark Renewal

**Kaesar**

(511) 09

(210) No. 31655

(220) 18/03/2014

(732) Kaeser Kompressoren SE

Carl-Kaeser-Str. 26, 96450 Coburg,

Germany

(111) No. 31931

(180) 05/04/2035

(540) Trademark Renewal

**Kaeser**

(511) 11

(210) No. 31656

(220) 18/03/2014

(732) Kaeser Kompressoren SE

Carl-Kaeser-Str. 26, 96450 Coburg,

Germany

(111) No. 31932

(180) 05/04/2035

(540) Trademark Renewal

**Kaeser**

(511) 16

(210) No. 31657

(220) 18/03/2014

(732) Kaeser Kompressoren SE

Carl-Kaeser-Str. 26, 96450 Coburg,

Germany

(111) No. 31933

(180) 05/04/2035

(540) Trademark Renewal

**Kaeser**

(511) 40

(210) No. 31661

(220) 18/03/2014

(732) Kaeser Kompressoren SE

Carl-Kaeser-Str. 26, 96450 Coburg,

Germany

(111) No. 31937

(180) 05/04/2035

(540) Trademark Renewal

**Sigma**

(511) 09

(210) No. 31665

(220) 18/03/2014

(732) Kaeser Kompressoren SE

Carl-Kaeser-Str. 26, 96450 Coburg,

Germany

(111) No. 31940

(180) 05/04/2035

(540) Trademark Renewal

**Sigma**

(511) 40

(210) No. 31669

(220) 18/03/2014

(732) Kaeser Kompressoren SE

Carl-Kaeser-Str. 26, 96450 Coburg,

Germany

(111) No. 31943

(180) 05/04/2035

(540) Trademark Renewal

**Sigma Control**

(511) 09

(210) No. 31671

(220) 18/03/2014

(732) Kaeser Kompressoren SE

Carl-Kaeser-Str. 26, 96450 Coburg,

Germany

(111) No. 31945

(180) 05/04/2035

(540) Trademark Renewal

**Sigma Air Manager**

(511) 09

(210) No. 31672

(220) 18/03/2014

(732) Kaeser Kompressoren SE

Carl-Kaeser-Str. 26, 96450 Coburg,

Germany

(111) No. 31946

(180) 05/04/2035

(540) Trademark Renewal

**Sigma Air Utility**

(511) 07

(210) No. 31673

(220) 18/03/2014

(732) Kaeser Kompressoren SE

Carl-Kaeser-Str. 26, 96450 Coburg,

Germany

(111) No. 31947

(180) 05/04/2035

(540) Trademark Renewal

**Sigma Air Utility**

(511) 40

(210) No. 31677

(220) 18/03/2014

(732) Kaeser Kompressoren SE

Carl-Kaeser-Str. 26, 96450 Coburg,

Germany

(111) No. 31951

(180) 05/04/2035

(540) Trademark Renewal

**Omega**

(511) 07

(210) No. 31678

(220) 18/03/2014

(732) Kaeser Kompressoren SE

Carl-Kaeser-Str. 26, 96450 Coburg,

Germany

(111) No. 31952

(180) 05/04/2035

(540) Trademark Renewal

**Mobilair**

(511) 07

(210) No. 31680

(220) 18/03/2014

(732) Kaeser Kompressoren SE

Carl-Kaeser-Str. 26, 96450 Coburg,

Germany

(111) No. 31954

(180) 05/04/2035

(540) Trademark Renewal

**Secotec**

(511) 11

(210) No. 31681

(220) 18/03/2014

(732) Kaeser Kompressoren SE

Carl-Kaeser-Str. 26, 96450 Coburg,

Germany

(111) No. 31955

(180) 05/04/2035

(540) Trademark Renewal

**Kryosec**

(511) 11

(210) No. 31682

(220) 18/03/2014

(732) Kaeser Kompressoren SE

Carl-Kaeser-Str. 26, 96450 Coburg,

Germany

(111) No. 31956

(180) 05/04/2035

(540) Trademark Renewal

**Hybritec**

(511) 11

(210) No. 31683

(220) 18/03/2014

(732) Kaeser Kompressoren SE

Carl-Kaeser-Str. 26, 96450 Coburg,

Germany

(111) No. 31957

(180) 05/04/2035

(540) Trademark Renewal



(511) 07

(210) No. 31685

(220) 18/03/2014

(732) Kaeser Kompressoren SE

Carl-Kaeser-Str. 26, 96450 Coburg,

Germany

(111) No. 31958

(180) 05/04/2035

(540) Trademark Renewal



(511) 35

(210) No. 31806

(220) 28/03/2014

(732) Beidahuang Group Co., Ltd.

No. 175 Hongqi Avenue Xiangfang District,

Harbin, Heilongjiang, China

(111) No. 32075

(180) 05/04/2035

(540) Trademark Renewal



(511) 36

(210) No. 31811

(220) 31/03/2014

(732) STARTS CORPORATION INC.

3-4-10, Nihonbashi, Chuo-ku, Tokyo

103-0027, Japan

(111) No. 32079

(180) 06/04/2035

(540) Trademark Renewal

**LA PRAIRIE**

(511) 03

(210) No. 31379

(220) 27/01/2014

(732) LABORATOIRES LA PRAIRIE SA.

Industriestrasse 8, 8604 Volketswil,

Swaziland

(111) No. 32081

(180) 13/03/2035

(540) Trademark Renewal



(511) 35

(210) No. 29356

(220) 05/06/2013

(732) OVERSEAS COURIER SERVICE CO.,  
LTD.

9-27, Tatsumi 3-chome, Koto-ku, Tokyo  
135-8527, Japan

(111) No. 32087

(180) 19/05/2035

(540) Trademark Renewal



(511) 39

(210) No. 29357

(220) 05/06/2013

(732) OVERSEAS COURIER SERVICE CO.,  
LTD.

9-27, Tatsumi 3-chome, Koto-ku, Tokyo  
135-8527, Japan

(111) No. 32088

(180) 19/05/2035

(540) Trademark Renewal

The logo consists of the letters 'HID' in a bold, serif font. The letters are dark with a lighter, slightly blurred shadow behind them, giving it a three-dimensional appearance.

(511) 09

(210) No. 29502

(220) 21/06/2013

(732) ASSA ABLOY AB.

P.O Box 70340, SE-107 23, Stockholm,  
Sweden

(111) No. 32090

(180) 19/05/2035

(540) Trademark Renewal

The logo consists of the letters 'HID' in a bold, serif font. The letters are dark with a lighter, slightly blurred shadow behind them, giving it a three-dimensional appearance.

(511) 42

(210) No. 29503

(220) 21/06/2013

(732) ASSA ABLOY AB.

P.O Box 70340, SE-107 23, Stockholm,  
Sweden

(111) No. 32091

(180) 19/05/2035

(540) Trademark Renewal



(511) 09

(210) No. 29504

(220) 21/06/2013

(732) ASSA ABLOY AB.

P.O Box 70340, SE-107 23, Stockholm,  
Sweden

(111) No. 32092

(180) 19/05/2035

(540) Trademark Renewal



(511) 42

(210) No. 29505

(220) 21/06/2013

(732) ASSA ABLOY AB.

P.O Box 70340, SE-107 23, Stockholm,  
Sweden

(111) No. 32093

(180) 19/05/2035

(540) Trademark Renewal

**HID GLOBAL**

(511) 09

(210) No. 29506

(220) 21/06/2013

(732) ASSA ABLOY AB.

P.O Box 70340, SE-107 23, Stockholm,  
Sweden

(111) No. 32094

(180) 19/05/2035

(540) Trademark Renewal

**HID GLOBAL**

(511) 42

(210) No. 29507

(220) 21/06/2013

(732) ASSA ABLOY AB.

P.O Box 70340, SE-107 23, Stockholm,  
Sweden

(111) No. 32095

(180) 19/05/2035

(540) Trademark Renewal

DEVONDALE

(511) 05

(210) No. 30464

(220) 03/10/2013

(732) Saputo Dairy Australia Pty Ltd.

Saputo Inc,6869 Blvd, Metropolitan East,  
St Leonard, Quebec, Canada, H1P 1XB,  
Canada

(111) No. 32109

(180) 19/05/2035

(540) Trademark Renewal

DEVONDALE

(511) 30

(210) No. 30465

(220) 03/10/2013

(732) Saputo Dairy Australia Pty Ltd.

Saputo Inc,6869 Blvd, Metropolitan East, St  
Leonard, Quebec, Canada, H1P 1XB,  
Canada

(111) No. 32110

(180) 19/05/2035

(540) Trademark Renewal



DEVONDALE

(511) 32

(210) No. 30466

(220) 03/10/2013

(732) Saputo Dairy Australia Pty Ltd.

Level 15, 2 Southbank Boulevard,

Southbank, Victoria, 3006, Australia

(111) No. 32111

(180) 19/05/2035

(540) Trademark Renewal



(511) 03

(210) No. 31865

(220) 03/04/2014

(732) COLGATE-PALMOLIVE COMPANY

300 Park Avenue, New York, New York

10022, United States of America

(111) No. 32346

(180) 07/07/2035

(540) Trademark Renewal



(511) 21

(210) No. 31868

(220) 03/04/2014

(732) COLGATE-PALMOLIVE COMPANY.

300 Park Avenue, New York, New York

10022, United States of America

(111) No. 32349

(180) 07/07/2035

(540) Trademark Renewal



(511) 03

(210) No. 31879

(220) 03/04/2014

(732) KAO KABUSHIKI KAISHA (also trading as  
Kao Corporation)

14-10, Nihonbashi Kayabacho 1-chome,

Chuo-ku, Tokyo, Japan

(111) No. 32358

(180) 08/07/2035

(540) Trademark Renewal



(511) 21

(210) No. 31880

(220) 03/04/2014

(732) KAO KABUSHIKI KAISHA (also trading as  
Kao Corporation)

14-10, Nihonbashi Kayabacho 1-chome,  
Chuo-ku, Tokyo, Japan

(111) No. 32359

(180) 08/07/2035

(540) Trademark Renewal

Frēshel

(511) 03

(210) No. 31881

(220) 03/04/2014

(732) KAO KABUSHIKI KAISHA (also trading as  
Kao Corporation)

14-10, Nihonbashi Kayabacho 1-chome,  
Chuo-ku, Tokyo, Japan

(111) No. 32360

(180) 08/07/2035

(540) Trademark Renewal

**Frēshel**

(511) 21

(210) No. 31882

(220) 03/04/2014

(732) KAO KABUSHIKI KAISHA (also trading as  
Kao Corporation)

14-10, Nihonbashi Kayabacho 1-chome,  
Chuo-ku, Tokyo, Japan

(111) No. 32361

(180) 08/07/2035

(540) Trademark Renewal

**LUNASOL**

(511) 03

(210) No. 31883

(220) 03/04/2014

(732) KAO KABUSHIKI KAISHA (also trading as  
Kao Corporation)

14-10, Nihonbashi Kayabacho 1-chome,  
Chuo-ku, Tokyo, Japan

(111) No. 32362

(180) 08/07/2035

(540) Trademark Renewal

**LUNASOL**

(511) 21

(210) No. 31884

(220) 03/04/2014

(732) KAO KABUSHIKI KAISHA (also trading as  
Kao Corporation)

14-10, Nihonbashi Kayabacho 1-chome,  
Chuo-ku, Tokyo, Japan

(111) No. 32363

(180) 08/07/2035

(540) Trademark Renewal

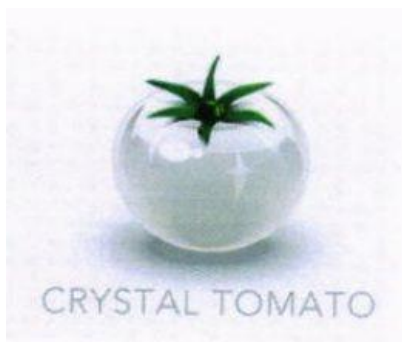

(511) 03

(210) No. 31955

(220) 21/04/2014

(732) GROMARK CONSUMERS ENTERPRISE  
PTE LTD.

1 Goldhill Plaza, #02-03 Podium Block,  
Singapore 308899., Singapore

(111) No. 32430

(180) 08/07/2035

(540) Trademark Renewal

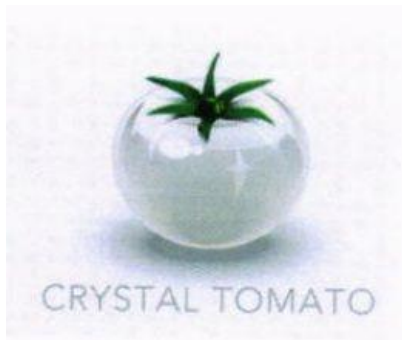

(511) 05

(210) No. 31956

(220) 21/04/2014

(732) GROMARK CONSUMERS ENTERPRISE  
PTE LTD.

1 Goldhill Plaza, #02-03 Podium Block,  
Singapore 308899., Singapore

(111) No. 32431

(180) 08/07/2035

(540) Trademark Renewal



(511) 12

(210) No. 31994

(220) 21/04/2014

(732) HYUNDAI MOTOR COMPANY

12, Heolleung-ro, Seocho-gu, Seoul,  
Korea (South), Republic of Korea

(111) No. 32468

(180) 08/07/2035

(540) Trademark Renewal

**KABASIJI**

(511) 09

(210) No. 32021

(220) 23/04/2014

(732) AO Kaspersky Lab

39A/2 Leningradskoe Shosse, Moscow,  
125212, Russian Federation

(111) No. 32494

(180) 08/07/2035

(540) Trademark Renewal

**KABASIJI**

(511) 42

(210) No. 32022

(220) 23/04/2014

(732) AO Kaspersky Lab

39A/2 Leningradskoe Shosse, Moscow,  
125212, Russian Federation

(111) No. 32495

(180) 08/07/2035

(540) Trademark Renewal

**KABASIGI**

(511) 09

(210) No. 32023

(220) 23/04/2014

(732) AO Kaspersky Lab

39A/2 Leningradskoe Shosse, Moscow,

125212, Russian Federation

(111) No. 32496

(180) 08/07/2035

(540) Trademark Renewal

**KABASIGI**

(511) 42

(210) No. 32024

(220) 23/04/2014

(732) AO Kaspersky Lab

39A/2 Leningradskoe Shosse, Moscow,

125212, Russian Federation

(111) No. 32497

(180) 08/07/2035

(540) Trademark Renewal



(511) 06

(210) No. 32073

(220) 28/04/2014

(732) YKK CORPORATION

1, Kanda Izumi-Cho, Chiyoda-Ku, Tokyo

101-8642, Japan

(111) No. 32546

(180) 07/07/2035

(540) Trademark Renewal



(511) 19

(210) No. 32074

(220) 28/04/2014

(732) YKK CORPORATION

1, Kanda Izumi-Cho, Chiyoda-Ku,

Tokyo 101-8642, Japan

(111) No. 32547

(180) 07/07/2035

(540) Trademark Renewal



(511) 32

(210) No. 32144

(220) 08/05/2014

(732) Dong-A Pharmaceutical Co., Ltd.

64, Cheonho-Daero, Dongdaemun-Gu,  
Seoul, Republic of Korea

(111) No. 32595

(180) 22/07/2035

(540) Trademark Renewal



(511) 32

(210) No. 32145

(220) 08/05/2014

(732) Dong-A Pharmaceutical Co., Ltd.

64, Cheonho-Daero, Dongdaemun-Gu,  
Seoul, Republic of Korea

(111) No. 32596

(180) 22/07/2035

(540) Trademark Renewal



(511) 03

(210) No. 32448

(220) 18/06/2014

(732) COLGATE-PALMOLIVE COMPANY

300 Park Avenue, New York, N.Y. 10022

United States of America

(111) No. 32894

(180) 02/08/2035

(540) Trademark Renewal

**NUCALA**

(511) 05

(210) No. 32479

(220) 20/06/2014

(732) Glaxo Group Limited

GSK Medicines Research Centre, Gunnels

Wood Road, Stevenage, SG1 2NY,

United Kingdom

(111) No. 32925

(180) 03/08/2035

(540) Trademark Renewal



(511) 09

(210) No. 32536

(220) 25/06/2014

(732) WIKO HONGKONG LIMITED

RM 1005, 10/F HO KING COMM CTR 2-  
16 FA YUEN ST MONGKOK, KL, HONG  
KONG, CHINA

(111) No. 32981

(180) 03/08/2035

(540) Trademark Renewal



(511) 38

(210) No. 32537

(220) 25/06/2014

(732) WIKO HONGKONG LIMITED

RM 1005, 10/F HO KING COMM CTR 2-  
16 FA YUEN ST MONGKOK, KL,  
HONG KONG, CHINA

(111) No. 32982

(180) 03/08/2035

(540) Trademark Renewal

**FLAIR**

(511) 03

(210) No. 32563

(220) 27/06/2014

(732) KAO KABUSHIKI KAISHA (also trading as  
Kao Corporation)

14-10, Nihonbashi Kayabacho 1-chome,  
Chuo-ku Tokyo, Japan

(111) No. 33005

(180) 03/08/2035

(540) Trademark Renewal

**Candiani**  
DENIM

(511) 24

(210) No. 32201

(220) 14/05/2014

(732) Candiani S.P.A.

Via Arese 85, 20020 Robecchetto Con  
Induno, Milano, ITALY, Italy

(111) No. 33026

(180) 05/08/2035

(540) Trademark Renewal

**ADVANCE**

(511) 34

(210) No. 32592

(220) 03/07/2014

(732) Netco United Pte. Ltd.

120 Lower Delta Road, #15-10 Cendex  
Centre, Singapore 169208, Singapore

(111) No. 33052

(180) 09/08/2035

(540) Trademark Renewal

**Boulevard**

(511) 34

(210) No. 32593

(220) 03/07/2014

(732) Netco United Pte. Ltd.

120 Lower Delta Road, #15-10 Cendex  
Centre, Singapore 169208, Singapore

(111) No. 33053

(180) 09/08/2035

(540) Trademark Renewal

**Campaign**

(511) 34

(210) No. 32594

(220) 03/07/2014

(732) Netco United Pte. Ltd.

120 Lower Delta Road, #15-10 Cendex  
Centre, Singapore 169208, Singapore

(111) No. 33054

(180) 09/08/2035

(540) Trademark Renewal

**dolce**

(511) 34

(210) No. 32595

(220) 03/07/2014

(732) Netco United Pte. Ltd.

120 Lower Delta Road, #15-10 Cendex  
Centre, Singapore 169208, Singapore

(111) No. 33055

(180) 09/08/2035

(540) Trademark Renewal

**PARKWAY**

(511) 34

(210) No. 32596

(220) 03/07/2014

(732) Netco United Pte. Ltd.

120 Lower Delta Road, #15-10 Cendex  
Centre, Singapore 169208, Singapore

(111) No. 33056

(180) 09/08/2035

(540) Trademark Renewal

**Princeton**

(511) 34

(210) No. 32597

(220) 03/07/2014

(732) Netco United Pte. Ltd.

120 Lower Delta Road, #15-10 Cendex  
Centre, Singapore 169208, Singapore

(111) No. 33057

(180) 09/08/2035

(540) Trademark Renewal

**Rave**

(511) 34

(210) No. 32598

(220) 03/07/2014

(732) Netco United Pte. Ltd.

120 Lower Delta Road, #15-10 Cendex  
Centre, Singapore 169208, Singapore

(111) No. 33058

(180) 09/08/2035

(540) Trademark Renewal



(511) 09

(210) No. 32605

(220) 04/07/2014

(732) LEGO Holding A/S

7190 Billund, Denmark

(111) No. 33065

(180) 10/08/2035

(540) Trademark Renewal



(511) 16

(210) No. 32606

(220) 04/07/2014

(732) LEGO Holding A/S

7190 Billund, Denmark

(111) No. 33066

(180) 10/08/2035

(540) Trademark Renewal



(511) 21

(210) No. 32607

(220) 04/07/2014

(732) LEGO Holding A/S

7190 Billund, Denmark

(111) No. 33067

(180) 10/08/2035

(540) Trademark Renewal



(511) 25

(210) No. 32608

(220) 04/07/2014

(732) LEGO Holding A/S

7190 Billund, Denmark

(111) No. 33068

(180) 10/08/2035

(540) Trademark Renewal



(511) 28

(210) No. 32609

(220) 04/07/2014

(732) LEGO Holding A/S

7190 Billund, Denmark

(111) No. 33069

(180) 10/08/2035

(540) Trademark Renewal



(511) 41

(210) No. 32610

(220) 04/07/2014

(732) LEGO Holding A/S

7190 Billund, Denmark

(111) No. 33070

(180) 10/08/2035

(540) Trademark Renewal

**HYUNDAI EON**

(511) 12

(210) No. 32674

(220) 16/07/2014

(732) Hyundai Motor Company (a Korean limited

liability company incorporated under the  
laws of Republic of Korea),

12, Heolleung-ro, Seocho-gu, Seoul, 137-  
938, Republic of Korea

(111) No. 33127

(180) 10/08/2035

(540) Trademark Renewal



(511) 29

(210) No. 32686

(220) 22/07/2014

(732) Duck King Co., Ltd.

49/3 M.2 Don Sai, Ban Pho, Chachoengsao

24140, Thailand

(111) No. 33141

(180) 10/08/2035

(540) Trademark Renewal

HUMMING

(511) 03

(210) No. 32925

(220) 19/08/2014

(732) KAO KABUSHIKI KAISHA (also trading as  
Kao Corporation)

14-10, Nihonbashi Kayabacho 1-chome,

Chuo-ku, Tokyo, Japan

(111) No. 33227

(180) 13/08/2035

(540) Trademark Renewal

The logo for PISEN, featuring the word "PISEN" in a bold, italicized, sans-serif font.

(511) 09

(210) No. 32787

(220) 04/08/2014

(732) GUANGDONG PISEN ELECTRONICS  
CO., LTD

No.9, Qinfu 1st Streer, Jintang Industrial  
Park, Niushipu Village, Liuyue, Henggang  
Town, Longgang District, Shenzhen City,  
Guangdong Province China

(111) No. 33243

(180) 13/08/2035

(540) Trademark Renewal

The logo for WOCOL, featuring the word "WOCOL" in a bold, italicized, sans-serif font.

(511) 09

(210) No. 32788

(220) 04/08/2014

(732) GUANGDONG PISEN ELECTRONICS  
CO., LTD.

No.9, Qinfu 1st Streer, Jintang Industrial  
Park, Niushipu Village, Liuyue, Henggang  
Town, Longgang District, Shenzhen City,  
Guangdong Province China

(111) No. 33244

(180) 13/08/2035

(540) Trademark Renewal

**TEX**

(511) 16

(210) No. 33227

(220) 23/09/2014

(732) THAI BALL PEN INDUSTRY CO., LTD.  
170 Soi Soonvijai 14, New Petchburi Road,  
Bangkapi, Huaykwang, Bangkok 10310,  
Thailand

(111) No. 33552

(180) 13/09/2035

(540) Trademark Renewal

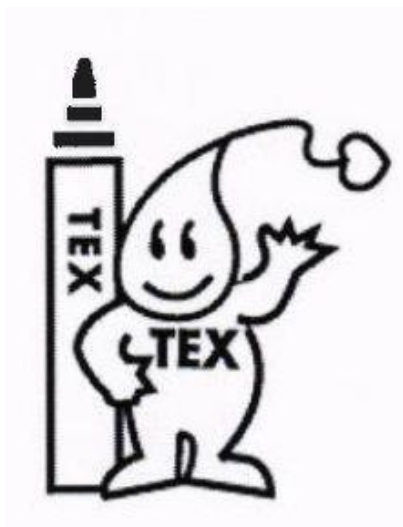

(511) 16

(210) No. 33228

(220) 23/09/2014

(732) THAI BALL PEN INDUSTRY CO., LTD.  
170 Soi Soonvijai 14, New Petchburi Road,  
Bangkapi, Huaykwang, Bangkok 10310,  
Thailand

(111) No. 33553

(180) 13/09/2035

(540) Trademark Renewal

**MAGICLEAN**

(511) 03

(210) No. 32995

(220) 04/09/2014

(732) KAO KABUSHIKI KAISHA (also trading as  
Kao Corporation)

14-10, Nihonbashi Kayabacho 1-chome,  
Chuo-ku, Tokyo, Japan

(111) No. 33653

(180) 14/09/2035

(540) Trademark Renewal

**MAGICLEAN**

(511) 05

(210) No. 32996

(220) 04/09/2014

(732) KAO KABUSHIKI KAISHA (also trading as  
Kao Corporation)

14-10, Nihonbashi Kayabacho 1-chome,  
Chuo-ku, Tokyo, Japan

(111) No. 33654

(180) 14/09/2035

(540) Trademark Renewal



(511) 09

(210) No. 33296

(220) 01/10/2014

(732) YEE FONG HUNG (MALAYSIA) SDN  
BHD.

No. 19 Jalan Jurunilai U1/20, Hicom  
Glenmarie Industrial Park, 40150 Shah  
Alam, Selangor Darul Ehsan, Malaysia

(111) No. 33737

(180) 21/09/2035

(540) Trademark Renewal



(511) 14

(210) No. 33297

(220) 01/10/2014

(732) YEE FONG HUNG (MALAYSIA) SDN  
BHD.

No. 19 Jalan Jurunilai U1/20, Hicom  
Glenmarie Industrial Park, 40150 Shah  
Alam, Selangor Darul Ehsan, Malaysia

(111) No. 33738

(180) 21/09/2035

(540) Trademark Renewal



(511) 18

(210) No. 33298

(220) 01/10/2014

(732) YEE FONG HUNG (MALAYSIA) SDN  
BHD.

No. 19 Jalan Jurunilai U1/20, Hicom  
Glenmarie Industrial Park, 40150 Shah  
Alam, Selangor Darul Ehsan, Malaysia

(111) No. 33739

(180) 21/09/2035

(540) Trademark Renewal



(511) 25

(210) No. 33299

(220) 01/10/2014

(732) YEE FONG HUNG (MALAYSIA) SDN  
BHD

No. 19 Jalan Jurunilai U1/20, Hicom  
Glenmarie Industrial Park, 40150 Shah  
Alam, Selangor Darul Ehsan, Malaysia

(111) No. 33740

(180) 21/09/2035

(540) Trademark Renewal



(511) 35

(210) No. 33300

(220) 01/10/2014

(732) YEE FONG HUNG (MALAYSIA) SDN  
BHD.

No. 19 Jalan Jurunilai U1/20, Hicom  
Glenmarie Industrial Park, 40150 Shah  
Alam, Selangor Darul Ehsan, Malaysia

(111) No. 33741

(180) 21/09/2035

(540) Trademark Renewal

**BRANDS OUTLET**

(511) 35

(210) No. 33301

(220) 01/10/2014

(732) YEE FONG HUNG (MALAYSIA) SDN  
BHD.

No. 19 Jalan Jurunilai U1/20, Hicom  
Glenmarie Industrial Park, 40150 Shah  
Alam, Selangor Darul Ehsan, Malaysia

(111) No. 33742

(180) 21/09/2035

(540) Trademark Renewal

**MERRIES**

(511) 03

(210) No. 33354

(220) 10/10/2014

(732) KAO KABUSHIKI KAISHA (also trading as  
Kao Corporation)

14-10, Nihonbashi Kayabacho 1-chome,  
Chuo-ku, Tokyo, Japan

(111) No. 33792

(180) 21/09/2035

(540) Trademark Renewal

**MERRIES**

(511) 21

(210) No. 33355

(220) 10/10/2014

(732) KAO KABUSHIKI KAISHA (also trading as  
Kao Corporation)

14-10, Nihonbashi Kayabacho 1-chome,  
Chuo-ku, Tokyo, Japan

(111) No. 33793

(180) 21/09/2035

(540) Trademark Renewal



(511) 43

(210) No. 33403

(220) 17/10/2014

(732) S&P SYNDICATE PUBLIC COMPANY  
LIMITED

2034/100-103, 23rd FLOOR, ITAL THAI  
TOWER, NEW PETCHBURI ROAD,  
BANGKAPI, HUAYKWANG BANGKOK  
10310, THAILAND

(111) No. 33841

(180) 21/09/2035

(540) Trademark Renewal



■ PANTONE 1545

■ PANTONE 299

(511) 30

(210) No. 33404

(220) 17/10/2014

(732) S&P SYNDICATE PUBLIC COMPANY  
LIMITED

2034/100-103, 23rd FLOOR, ITAL THAI  
TOWER, NEW PETCHBURI ROAD,  
BANGKAPI, HUAYKWANG BANGKOK  
10310, THAILAND

(111) No. 33842

(180) 21/09/2035

(540) Trademark Renewal



(511) 43

(210) No. 33405

(220) 17/10/2014

(732) S&P SYNDICATE PUBLIC COMPANY  
LIMITED

2034/100-103, 23rd FLOOR, ITAL THAI  
TOWER, NEW PETCHBURI ROAD,  
BANGKAPI, HUAYKWANG BANGKOK  
10310, THAILAND

(111) No. 33843

(180) 21/09/2035

(540) Trademark Renewal



(511) 01

(210) No. 33579

(220) 07/11/2014

(732) Emery Oleochemicals GmbH

Paul-Thomas-Strasse 56, 40599 Düsseldorf,  
Germany

(111) No. 34019

(180) 06/10/2035

(540) Trademark Renewal



(511) 08

(210) No. 33616

(220) 13/11/2014

(732) CÔNG TY CỔ PHẦN KEM NGHĨA  
(NGHIA NIPPERS CORPORATION)

10/20 Lạc Long Quân Str., Ward 9, Tân Bình  
District, Ho Chi Minh City, Vietnam

(111) No. 34053

(180) 05/10/2035

(540) Trademark Renewal



(511) 08

(210) No. 33617

(220) 13/11/2014

(732) CÔNG TY CỔ PHẦN KEM NGHĨA  
(NGHIA NIPPERS CORPORATION)

10/20 Lạc Long Quân Str., Ward 9, Tân Bình  
District, Ho Chi Minh City, Vietnam

(111) No. 34054

(180) 05/10/2035

(540) Trademark Renewal



(511) 08

(210) No. 33618

(220) 13/11/2014

(732) CONG TY CO PHAN KEM NGHIA  
(NGHIA NIPPERS CORPORATION)

10/20 Lac Long Quan Str., Ward 9, Tan Binh  
District, Ho Chi Minh City, Vietnam

(111) No. 34055

(180) 05/10/2035

(540) Trademark Renewal

**RYUKA**

(511) 12

(210) No. 33664

(220) 18/11/2014

(732) ZONSEN INDUSTRIAL GROUP CO.,  
LTD.

Chaoyouchang, Huaxizhen, Bananqu,  
Chongqing, China

(111) No. 34099

(180) 05/10/2035

(540) Trademark Renewal



(511) 09

(210) No. 33665

(220) 18/11/2014

(732) ONEPLUS TECHNOLOGY (SHENZHEN)  
CO., LTD.

18C02, 18C03, 18C04, AND 18C05, SHUM  
YIP TERRA BUILDING, BINHE AVENUE  
NORTH, FUTIAN DISTRICT,  
SHENZHEN, GUANGDONG, CHINA

(111) No. 34100

(180) 06/10/2035

(540) Trademark Renewal



(511) 35

(210) No. 33698

(220) 25/11/2014

(732) SHENZHEN HUAFURUI TECHNOLOGY  
CO., LTD.

Room 07B, Tower A, Modern Window  
Building, Huaqiang North Road, Futian  
District, Shenzhen, P.R. China

(111) No. 34131

(180) 06/10/2035

(540) Trademark Renewal

**CUBOT**

(511) 09

(210) No. 33699

(220) 25/11/2014

(732) SHENZHEN HUAUFURUI TECHNOLOGY  
CO., LTD.

Room 07B, Tower A, Modern Window  
Building, Huaqiang North Road, Futian  
District, Shenzhen, P.R. China

(111) No. 34132

(180) 06/10/2035

(540) Trademark Renewal

Canyon

(511) 34

(210) No. 33778

(220) 03/12/2014

(732) Netco United Pte. Ltd.

120 Lower Delta Road, #15-10 Cendex  
Centre, Singapore 169208, Singapore

(111) No. 34218

(180) 28/10/2035

(540) Trademark Renewal



(511) 35

(210) No. 33915

(220) 17/12/2014

(732) BANYAN TREE HOLDINGS LIMITED

211 Upper Bukit Timah Road Singapore

588182, Singapore

(111) No. 34343

(180) 29/10/2035

(540) Trademark Renewal



(511) 36

(210) No. 33916

(220) 17/12/2014

(732) BANYAN TREE HOLDINGS LIMITED

211 Upper Bukit Timah Road Singapore

588182, Singapore

(111) No. 34344

(180) 29/10/2035

(540) Trademark Renewal



(511) 43

(210) No. 33917

(220) 17/12/2014

(732) BANYAN TREE HOLDINGS LIMITED

211 Upper Bukit Timah Road Singapore

588182, Singapore

(111) No. 34345

(180) 29/10/2035

(540) Trademark Renewal



(511) 44

(210) No. 33918

(220) 17/12/2014

(732) BANYAN TREE HOLDINGS LIMITED

211 Upper Bukit Timah Road Singapore

588182, Singapore

(111) No. 34346

(180) 29/10/2035

(540) Trademark Renewal



**MYCOM**

(511) 07

(210) No. 33937

(220) 19/12/2014

(732) MAYEKAWA MFG. CO., LTD.

14-15, Botan 3-chome, Koto-ku, Tokyo

135-8482, Japan

(111) No. 34365

(180) 28/10/2035

(540) Trademark Renewal



**MYCOM**

(511) 11

(210) No. 33938

(220) 19/12/2014

(732) MAYEKAWA MFG. CO., LTD.

14-15, Botan 3-chome, Koto-ku, Tokyo

135-8482, Japan

(111) No. 34366

(180) 28/10/2035

(540) Trademark Renewal

The logo for MAYEKAWA, featuring the word "MAYEKAWA" in a bold, black, sans-serif font. The letter "M" is stylized with a red outline and a white fill, while the remaining letters are solid black.

(511) 07

(210) No. 33939

(220) 19/12/2014

(732) MAYEKAWA MFG. CO., LTD.

14-15, Botan 3-chome, Koto-ku, Tokyo

135-8482, Japan

(111) No. 34367

(180) 28/10/2035

(540) Trademark Renewal

The logo for MAYEKAWA, featuring the word "MAYEKAWA" in a bold, black, sans-serif font. The letter "M" is stylized with a red outline and a white fill, while the remaining letters are solid black.

(511) 11

(210) No. 33940

(220) 19/12/2014

(732) MAYEKAWA MFG. CO., LTD.

14-15, Botan 3-chome, Koto-ku, Tokyo

135-8482, Japan

(111) No. 34368

(180) 28/10/2035

(540) Trademark Renewal

**HOSHIZAKI**

(511) 11

(210) No. 33947

(220) 22/12/2014

(732) HOSHIZAKI CORPORATION

3-16, Minamiyakata, Sakae-cho,

Toyoake-shi, Aichi, Japan

(111) No. 34374

(180) 29/10/2035

(540) Trademark Renewal



(511) 11

(210) No. 33948

(220) 22/12/2014

(732) HOSHIZAKI CORPORATION

3-16, Minamiyakata, Sakae-cho,

Toyoake-shi, Aichi, Japan

(111) No. 34375

(180) 29/10/2035

(540) Trademark Renewal

**HORTON  
INTERNATIONAL**

(511) 35

(210) No. 33995

(220) 29/12/2014

(732) Horton Group International Limited

Belmont House, 13 Upper High Street,

Thame, Oxfordshire OX9 3ER,

United Kingdom

(111) No. 34422

(180) 29/10/2035

(540) Trademark Renewal

The logo for N.Cat, featuring the text "N.Cat" in a red, cursive, handwritten-style font. The "N" is large and prominent, followed by a period and "Cat".

(511) 14

(210) No. 34817

(220) 22/04/2015

(732) NAUGHTYCAT CO., LTD.

3-20, Toegyero 6 gil, Jung-gu, Seoul,

Republic of Korea

(111) No. 35226

(180) 14/03/2036

(540) Trademark Renewal

The logo consists of the text "N.Cat" written in a red, cursive, handwritten-style font. The "N" is large and prominent, followed by a period and the word "Cat".

(511) 18

(210) No. 34818

(220) 22/04/2015

(732) NAUGHTYCAT CO., LTD.

3-20, Toegyero 6 gil, Jung-gu, Seoul,

Republic of Korea

(111) No. 35227

(180) 14/03/2036

(540) Trademark Renewal

The logo consists of the text "N.Cat" written in a red, cursive, handwritten-style font. The "N" is large and prominent, followed by a period and the word "Cat".

(511) 26

(210) No. 34819

(220) 22/04/2015

(732) NAUGHTYCAT CO., LTD.

3-20, Toegyero 6 gil, Jung-gu, Seoul,

Republic of Korea

(111) No. 35228

(180) 14/03/2036

(540) Trademark Renewal

**Ravenol**

(511) 01

(210) No. 35182

(220) 11/06/2015

(732) Ravensberger Schmierstoffvertrieb GmbH

Jöllenbecker Straße 2, 33824 Werther,

Germany

(111) No. 35574

(180) 29/05/2036

(540) Trademark Renewal

**Ravenol**

(511) 04

(210) No. 35183

(220) 11/06/2015

(732) Ravensberger Schmierstoffvertrieb GmbH

Jöllenbecker Straße 2, 33824 Werther,

Germany

(111) No. 35575

(180) 29/05/2036

**ພາກທີ III**  
**(Part III)**

**ເຄື່ອງໝາຍການຄ້າ**  
**Trademarks**

**4. ການປ່ຽນແປງ**  
**(Changes)**

**ພາກທີ III**  
**(Part III)**  
**ເຄື່ອງໝາຍການຄ້າ**  
**Trademarks**

**5. ການດັດແກ້**  
**(Amendments)**

## ພາກທີ IV

### (Part IV)

## ເຄື່ອງໝາຍການຄ້າຜ່ານລະບົບມາດຣິດ

## Trademarks via Madrid Protocol

### 1. ຄໍາຮ້ອງ

### (Applications)

#### ຄໍາອະທິບາຍກ່ຽວກັບລະຫັດຫຍໍ້

#### (Introduction of Codes)

- (540) ເຄື່ອງໝາຍການຄ້າ (Trademark)
- (511) ໝວດ (Nice Classification)
- (210) ເລກທີ ຄໍາຮ້ອງ (Number of the application)
- (220) ວັນທີ ຄໍາຮ້ອງ (Date of filing of the application)
- (732) ຊື່ ແລະ ທີ່ຢູ່ ຂອງຜູ້ຍື່ນຄໍາຮ້ອງ (Name and Address of applicant)

(540)Madrid Application



(511) 33

(210) No. M/0853537

(220) 12/03/2026

(732) FRATELLI BRANCA DISTILLERIE S.p.A.  
VIA BROLETTO, 35 I-20121 MILANO,  
ITALY

(540)Madrid Application

**VONYX**

(511) 09

(210) No. M/1313867

(220) 05/12/2025

(732) Tronios Group International B.V.  
Bedrijvenpark Twente N 18 NL-7602 KR  
Almelo, The Netherlands

(540)Madrid Application



(511) 29

(210) No. M/1844958

(220) 19/01/2026

(732) TIANJIN CSS TRADING CO., LTD.

No.15, Shuangchen Middle Road, Tianjin

Beichen Economic and Technological

Development Zone, Beichen District Tianjin,

China

(540)Madrid Application

TOPPAN

(511) 02, 07, 09, 11, 16, 17, 21, 28, 35, 39, 40, 41  
and 42

(210) No. M/1861488

(220) 06/03/2026

(732) TOPPAN Holdings Inc.

5-1, Taito 1-chome, Taito-ku Tokyo

110-0016, Japan

(540)Madrid Application

**KOMATSU**

(511) 20

(210) No. M/1881486

(220) 19/03/2026

(732) KOMATSU LTD.

1-2-20, Kaigan, Minato-ku Tokyo 105-8316,  
Japan

(540)Madrid Application

**WRANGLER ALL  
TERRAIN GEAR**

(511) 25

(210) No. M/1899963

(220) 09/01/2026

(732) Wrangler Apparel Corp.

3411 Silverside Road Wilmington DE 19810,  
United States of America

(540)Madrid Application

**AIRTECH  
THERMALOFT**

(511) 18, 25 and 35

(210) No. M/1901504

(220) 07/01/2026

(732) SHINSUNG TONGSANG CO., LTD.

84, Pungseong-ro 63-gil, Gangdong-gu Seoul,  
Republic of Korea

(540)Madrid Application

**AURLIXEEZ**

(511) 05

(210) No. M/1901665

(220) 13/01/2026

(732) Praxis Precision Medicines, Inc.

99 High Street, 30th Floor Boston MA 02110,  
United States of America

(540)Madrid Application

**LIXQUETO**

(511) 05

(210) No. M/1901837

(220) 15/01/2026

(732) Praxis Precision Medicines, Inc.

99 High Street, 30th Floor Boston MA 02110,  
United States of America

(540)Madrid Application

**PL.PAUL**

(511) 25

(210) No. M/1901988

(220) 05/01/2026

(732) GOLDEN CHARM MANAGEMENT PTE.  
LTD.

60 PAYA LEBAR ROAD, #04-16 PAYA  
LEBAR SQUARE SINGAPORE 409051,  
SINGAPORE

(540)Madrid Application

**PRADOREY**

(511) 33

(210) No. M/1902941

(220) 09/01/2026

(732) REAL SITIO DE VENTOSILLA, S.A.

Ctra CL-619 (Magaz-Aranda), km. 66,1 E-  
09443 Gumiel de Mercado (Burgos), Spain

(540)Madrid Application

**Wrangler** 

(511) 25

(210) No. M/1902975

(220) 09/01/2026

(732) Wrangler Apparel Corp.

3411 Silverside Road Wilmington DE 19810,  
United States of America

(540)Madrid Application

**OXY**

(511) 03 and 05

(210) No. M/1903894

(220) 21/01/2026

(732) THE MENTHOLATUM COMPANY

707 Sterling Drive, Orchard Park New York  
New York 14127, United States of America

(540)Madrid Application



(511) 03

(210) No. M/1904425

(220) 24/02/2026

(732) Byearth Co., Ltd.

6th Floor, 5, Samseong-ro 76-gil, Gangnam-  
gu Seoul 06185, Republic of Korea

(540)Madrid Application

**ABFinance**

(511) 09, 35, 36, 41 and 42

(210) No. M/1905225

(220) 16/01/2026

(732) PUBLIC GOODS PTE. LTD.

18 HOWARD ROAD, #08-07 NOVELTY  
BIZCENTRE SINGAPORE 369585,  
SINGAPORE

(540)Madrid Application

**Absolute Finance**

(511) 09, 35, 36, 41 and 42

(210) No. M/1905226

(220) 16/01/2026

(732) PUBLIC GOODS PTE. LTD.

18 HOWARD ROAD, #08-07 NOVELTY  
BIZCENTRE SINGAPORE 369585,  
SINGAPORE

(540)Madrid Application

**RDRD**

(511) 03

(210) No. M/1905522

(220) 05/02/2026

(732) iFamilySC Co., Ltd.

122, Dongnam-ro, Songpa-gu Seoul,  
Republic of Korea

(540)Madrid Application

**FEASTABLES**

(511) 29

(210) No. M/1906228

(220) 13/02/2026

(732) Feastables, Inc.

167 N. Green St., 4th Floor Chicago IL  
60607, United States of America

(540)Madrid Application

**PE<sup>+</sup>PAIR**

(511) 03 and 05

(210) No. M/1906262

(220) 19/01/2026

(732) BELLEBRISE BIO PTE. LTD.

133 CECIL STREET, #18-02 KECK SENG  
TOWER SINGAPORE 069535,  
SINGAPORE

(540)Madrid Application

**REDRED**

(511) 03

(210) No. M/1906307

(220) 05/02/2026

(732) iFamilySC Co., Ltd.

122, Dongnam-ro, Songpa-gu Seoul,  
Republic of Korea

(540)Madrid Application

**Delivering trust in  
motion**

(511) 12 and 35

(210) No. M/1906371

(220) 03/02/2026

(732) TMD Friction Services GmbH

Schlebuscher Str. 99 51381 Leverkusen,  
Germany

(540)Madrid Application

**Life, made lighter**

(511) 35

(210) No. M/1906385

(220) 29/01/2026

(732) Novo Nordisk A/S

Novo Alle 1 DK-2880 Bagsvaerd, Denmark

(540)Madrid Application

**NEXUS**

(511) 31

(210) No. M/1906527

(220) 08/01/2026

(732) Hendrix Genetics B.V.

Spoorstraat 69 NL-5831 CK Boxmeer,  
The Netherlands

(540)Madrid Application

**Beluv**

(511) 31

(210) No. M/1906846

(220) 05/01/2026

(732) Fubei (SHANGHAI) Co., Ltd.

No. 1-8, Lane 366, Xutang Road, Songjiang  
District Shanghai, China

(540)Madrid Application

**WSOT**

(511) 09, 35, 36, 41 and 42

(210) No. M/1907039

(220) 16/01/2026

(732) Bybit Technology Limited

F2-2A, 2nd Floor, Oceanic House, Providence  
Estate Mahe, Seychelles

(540)Madrid Application

**FRANKLY**

(511) 03

(210) No. M/1907206

(220) 12/01/2026

(732) TheKooky Co., Ltd.

#412, 171, Gasan digital 1-ro, Geumcheon-gu  
Seoul, Republic of Korea

(540)Madrid Application



**audizio**

(511) 09 and 35

(210) No. M/1907223

(220) 20/01/2026

(732) Tronios Group International B.V.

Bedrijvenpark Twente N 18 NL-7602 KR

Almelo, The Netherlands

(540)Madrid Application



**YUEDPAO**

(511) 18 and 25

(210) No. M/1907249

(220) 20/01/2026

(732) MR. TANONGSAK SAEAW

11/5 Soi Phoemsin 20 Yaek 2, Khlong

Thanon Sub-district 10220 Sai Mai District,

Bangkok, Thailand

(540)Madrid Application

**FURSYS**

(511) 20 and 35

(210) No. M/1907436

(220) 05/01/2026

(732) FURSYS INC.

311, Ogeum-ro, Songpa-gu Seoul 05661,  
Republic of Korea

(540)Madrid Application

**PROMPTFORGE**

(511) 41

(210) No. M/1907453

(220) 28/01/2026

(732) i49 Group Inc.

5805 State Bridge Road, Suite G301  
DULUTH GA 30097,  
United States of America

(540)Madrid Application

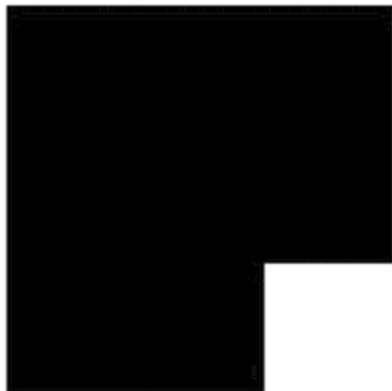

(511) 20 and 35

(210) No. M/1908088

(220) 05/01/2026

(732) FURSYS INC.

311, Ogeum-ro, Songpa-gu Seoul 05661,  
Republic of Korea

(540)Madrid Application

**TYTAN**

(511) 28

(210) No. M/1908240

(220) 02/02/2026

(732) ZURU IP LIMITED

RM 1201-04, 12/F ENERGY PLAZA, 92  
GRANVILLE RD, TSIM SHA TSUI,  
KOWLOON HONG KONG, CHINA

(540)Madrid Application

**CF**

(511) 03

(210) No. M/1908249

(220) 19/02/2026

(732) Grant Washington-Smith

576 River Road, Fairfield Hamilton 3214,  
New Zealand

(540)Madrid Application

**NOTED  
COLLECTION**

(511) 35, 36 and 43

(210) No. M/1908397

(220) 23/01/2026

(732) Six Continents Limited

1 Windsor Dials, Arthur Road Windsor,  
Berkshire SL4 1RS, United Kingdom

(540)Madrid Application

**APPLECARE ONE**

(511) 35

(210) No. M/1908533

(220) 22/01/2026

(732) Apple Inc.

One Apple Park Way Cupertino CA 95014,  
United States of America

(540)Madrid Application

**ECOLAB  
CONVEYOR  
MANAGEMENT IQ**

(511) 42

(210) No. M/1908588

(220) 04/02/2026

(732) Ecolab USA Inc.

1 Ecolab Place St. Paul MN 55102,  
United States of America

(540)Madrid Application

AscendAsia 

(511) 35, 36 and 42

(210) No. M/1908660

(220) 28/01/2026

(732) Ascend Asia Financial Services Group Pte.  
Ltd.

9 RAFFLES PLACE, #26-01, REPUBLIC

PLAZA SINGAPORE 048619, SINGAPORE

(540)Madrid Application



(511) 35, 36 and 42

(210) No. M/1908661

(220) 28/01/2026

(732) Ascend Asia Financial Services Group Pte.  
Ltd.

9 RAFFLES PLACE, #26-01, REPUBLIC

PLAZA SINGAPORE 048619, SINGAPORE

(540)Madrid Application

**WHC**

(511) 05 and 35

(210) No. M/1909358

(220) 09/01/2026

(732) WHC LABS, besloten vennootschap

Prins Boudewijnlaan 7A bus 3 B-2550 Kontich,  
Belgium

(540)Madrid Application

 **Fortified**

(511) 05

(210) No. M/1909535

(220) 16/01/2026

(732) FORTIFIED GLOBAL LTD

9 PARK PLACE, NEWDIGATE ROAD,  
HAREFIELD GREATER LONDON UB9  
6EJ, UNITED KINGDOM

(540)Madrid Application

全季大观 GRAND JI HOTEL

(511) 35 and 43

(210) No. M/1909721

(220) 15/01/2026

(732) H WORLD HOLDINGS SINGAPORE PTE.  
LTD.

11 PENANG LANE, JI HOTEL ORCHARD  
SINGAPORE SINGAPORE 238485,  
SINGAPORE

(540)Madrid Application

**ZEKKA**

(511) 05

(210) No. M/1909969

(220) 19/02/2026

(732) ZERO PLUS Co., Ltd.

5F, Hakata 1091 Building, 1-2-2,  
Hakataekiminami, Hakata-ku, Fukuoka-shi  
Fukuoka 812-0016, Japan

(540)Madrid Application



(511) 18, 25 and 35

(210) No. M/1910086

(220) 04/02/2026

(732) RERMMAI COMPANY LIMITED

11/5 Soi Phoemsin 20 Yaek 2, Khlong

Thanon Sub-district Sai Mai District,

Bangkok 10220, Thailand

(540)Madrid Application

**SCOPHIL CP-101**

(511) 03, 05, 10 and 30

(210) No. M/1910114

(220) 30/01/2026

(732) Yurala Co., Ltd.

1-23-2 Toranomom, Minato-ku Tokyo

105-0001, Japan

(540)Madrid Application

**Mighty Pedal**

(511) 35

(210) No. M/1910301

(220) 26/01/2026

(732) MIGHTY SPARTAN PTE. LTD.

60 PAYA LEBAR ROAD, #07-54 PAYA  
LEBAR SQUARE SINGAPORE 409051,  
SINGAPORE

(540)Madrid Application

**SNSI**

(511) 41

(210) No. M/1910407

(220) 20/02/2026

(732) Forsaken LLC

1669 SE South Niemeyer Cir #109 Port St.  
Lucie FL 34952, United States of America

(540)Madrid Application

**Bell winner**

(511) 09, 28 and 41

(210) No. M/1910444

(220) 27/11/2025

(732) Euro Games Technology Ltd.

Panorama Sofia Str. 6, Richhill Business

Center, ground floor BG-1766 Vitosha Region,

Sofia, Bulgaria

(540)Madrid Application

 **OCASEY**

(511) 09 and 35

(210) No. M/1910463

(220) 18/02/2026

(732) Obshchestvo s ogranichennoj

otvetstvennost'yu "ELION"

str. 26, pomeshch. 470, 21-j km (Varshavskoe

sh. ter.) p. Bitca g. Vidnoe RU-142718

Moskovskaya oblast, Russian Federation

(540)Madrid Application



(511) 09

(210) No. M/1910527

(220) 20/01/2026

(732) Tronios Group International B.V.

Bedrijvenpark Twente N 18 NL-7602 KR

Almelo, The Netherlands

(540)Madrid Application

**Crominex 3+**

(511) 01 and 05

(210) No. M/1910537

(220) 12/12/2025

(732) Kerry Group Services International Limited

Prince's Street Tralee, County Kerry V92

EH11, Ireland

(540)Madrid Application

**XTREMEPASS**

(511) 09

(210) No. M/1910568

(220) 02/03/2026

(732) Amphenol Corporation

358 Hall Avenue Wallingford CT 06492,  
United States of America

(540)Madrid Application

**MACBOOK NEO**

(511) 09

(210) No. M/1910587

(220) 04/03/2026

(732) Apple Inc.

One Apple Park Way Cupertino CA 95014,  
United States of America

(540)Madrid Application

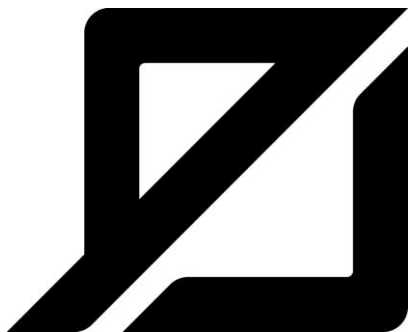

(511) 09

(210) No. M/1910632

(220) 20/01/2026

(732) Tronios Group International B.V.

Bedrijvenpark Twente N 18 NL-7602 KR

Almelo, The Netherlands

(540)Madrid Application

**ONX**

(511) 07, 10, 11, 21 and 28

(210) No. M/1910712

(220) 25/09/2025

(732) IAM Technology Group (Xiamen) Co., Ltd

Room 1001, No. 386, Qishan Road, Huli

District, Xiamen Fujian Province, China

(540)Madrid Application

名代 宇奈魚魚

(511) 30 and 43

(210) No. M/1910843

(220) 21/01/2026

(732) G-FACTORY CO.,LTD.

34F SHINJUKU CENTER BLDG 1-25-1,  
Nishishinjuku, Shinjuku-ku Tokyo 163-0634,  
Japan

(540)Madrid Application

capros 

(511) 01 and 05

(210) No. M/1910900

(220) 07/01/2026

(732) Kerry Group Services International Limited

Prince's Street Tralee, County Kerry V92  
EH11, Ireland

(540)Madrid Application

The logo for Sensoril, featuring a stylized blue 'S' with a white outline, followed by the word 'ensoril' in a blue, sans-serif font.

(511) 01 and 05

(210) No. M/1910901

(220) 07/01/2026

(732) Kerry Group Services International Limited  
Prince's Street Tralee, County Kerry V92  
EH11, Ireland

(540)Madrid Application

The Chinese characters '豆', '黄', and '金' are stacked vertically in a large, bold, black font. The character '豆' (Dou) has a stylized leaf-like shape at its base. '黄' (Huang) is a standard character for yellow. '金' (Jin) has a stylized leaf-like shape at its base.

(511) 29

(210) No. M/1911023

(220) 10/09/2025

(732) DOUHUANGJIN FOOD CO., LTD.  
(North Of The Highway Exit) Industrial Park,  
Shangye Town, Fei County, Linyi City  
Shandong Province, China

(540)Madrid Application

**BUAUSS**

(511) 09

(210) No. M/1911073

(220) 30/12/2025

(732) Yongxin Technology (Shenzhen) Co., Ltd.

Room 14C, Huayue Pavilion, Nanhua

Garden, No. 2002 Huaqiang South Road,

Jinlong Community, Nanyuan Street, Futian

District, Shenzhen 518000 Guangdong

Province, China

(540)Madrid Application

**ANN ANDELMAN**

(511) 25

(210) No. M/1911076

(220) 12/03/2026

(732) Guangzhou Gaoqian Trading Co., Ltd.

Shop 118, Block 2, No.18 Xinye Road,

Haizhu District, Guangzhou City 510000

Guangdong Province, China

(540)Madrid Application

**COLEOLOGY CUTTING JELLY**

(511) 05 and 29

(210) No. M/1911083

(220) 12/11/2025

(732) Adapt Inc.

4F, 534, Samseong-ro, Gangnam-gu Seoul,  
Republic of Korea

(540)Madrid Application

**MOSSILY**

(511) 09

(210) No. M/1911120

(220) 02/12/2025

(732) Guangzhou Youchuangpin Technology Co.,  
Ltd.

Room 1612, No. 17 Tongyuan Street, Haizhu  
District 518000 Guangzhou City, Guangdong  
Province, China

(540)Madrid Application



(511) 01 and 05

(210) No. M/1911125

(220) 31/12/2025

(732) Kerry Group Services International Limited

Prince's Street Tralee, County Kerry V92

EH11, Ireland

(540)Madrid Application

**FRONT RUNNER**

(511) 35

(210) No. M/1911143

(220) 05/12/2025

(732) Front Runner AU Pty Ltd

15 Pakington St Geelong West VIC 3218,

Australia

(540)Madrid Application



(511) 33

(210) No. M/1911156

(220) 09/02/2026

(732) PICCADILY AGRO INDUSTRIES  
LIMITED

G-17, GF, Sector-15, Part-II, JMD Pacific  
Square, Gurgaon Haryana 122002, India

(540)Madrid Application

**yoishut**

(511) 05

(210) No. M/1911187

(220) 26/02/2026

(732) zekka Co., Ltd.

5F, Hakata 1091 Building, 1-2-2,

Hakataekiminami, Hakata-ku, Fukuoka-shi

Fukuoka 812-0016, Japan

(540)Madrid Application



(511) 43

(210) No. M/1911233

(220) 01/10/2025

(732) CHOI, SUA and SHIN, Kyung Chol

101-Ho, 71-7, Bukhansan-ro, 387beon-gil,

Deogyang-gu, Goyang-si Gyeonggi-do

10580, Republic of Korea and 105-3501, 23,

Sinbanpo-ro 23-gil, Seocho-gu Seoul 06509,

Republic of Korea

(540)Madrid Application



(511) 01 and 05

(210) No. M/1911284

(220) 07/01/2026

(732) BIOSEARCH, S.A.

Camino de Purchil, nº 66 E-18004

GRANADA, Spain

(540)Madrid Application

The logo for MCHANIX features the word "MCHANIX" in a bold, sans-serif font. The letters "M", "C", "H", "A", "N", and "I" are solid black, while the "X" is composed of a series of horizontal lines that taper to the right, creating a dynamic, arrow-like effect.

(511) 12

(210) No. M/1911285

(220) 29/01/2026

(732) Megacell International Company Limited  
65/156-157 Chamnan Phenjati Bldg., 19th  
Fl., Rama IX Road, Huaykwang Sub-District  
10320 Huaykwang District, Bangkok,  
Thailand

(540)Madrid Application

The logo for AREXA consists of the word "AREXA" in a bold, serif font, with all letters in uppercase.

(511) 12

(210) No. M/1911344

(220) 01/12/2025

(732) T2 GLOBAL TRADE LIMITED  
239-241 Kennington Lane LONDON SE11  
5QU, United Kingdom

(540)Madrid Application

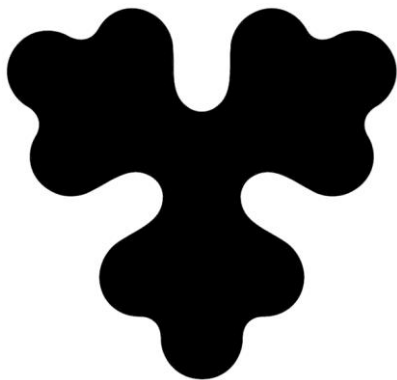

(511) 32 and 33

(210) No. M/1911353

(220) 24/12/2025

(732) Carlsberg A/S

J.C. Jacobsens Gade 1 DK-1799 Copenhagen  
V, Denmark

(540)Madrid Application

**MATE MADE**  
Made we Mate

(511) 03, 09, 14, 18 and 25

(210) No. M/1911355

(220) 05/12/2025

(732) CONG TY TNHH KINH DOANH THUONG  
MAI HTC VIET NAM (HTC VIETNAM  
COMMERCIAL BUSINESS COMPANY  
LIMITED)

No. 23 To Vinh Dien, Khuong Dinh Ward  
Hanoi City, Vietnam

(540)Madrid Application

The logo for TCITY, featuring the letters 'TCITY' in a bold, blue, sans-serif font. The 'T' and 'C' are connected, and the 'Y' has a distinctive shape with a horizontal bar.

(511) 09, 11 and 12

(210) No. M/1911364

(220) 07/01/2026

(732) Shenzhen T-City Electronics Co., Ltd

10th Floor, Xingqiang Commercial Building,  
No. 4 Dezheng Road, Shilong Community,  
Shiyan Street, Bao'an District, Shenzhen City  
Guangdong Province, China

(540)Madrid Application

The logo for 富恒 (Fù Héng), featuring the Chinese characters '富' and '恒' in a bold, black, sans-serif font.

(511) 29

(210) No. M/1911365

(220) 23/12/2025

(732) Zhang Wen

No.401, Building 29 South, Yingshan  
Community, Yueyanglou District, Yueyang  
City 414000 Hunan Province, China

(540)Madrid Application

**chéeryep**

(511) 03

(210) No. M/1911366

(220) 05/12/2025

(732) Nanjing shi er chai Cosmetics Co., LTD

Room 1705-1706 Yuqiao International

AparTment, No. 8 Jianning Road, Gulou

District, Nanjing City 210037 Jiangsu

Province, China

(540)Madrid Application

**PF<sup>+</sup>79**

(511) 03

(210) No. M/1911377

(220) 24/12/2025

(732) Beijing Zhen Yan Li She Business & Trade

Co., Ltd.

No. 1-F51, Gu Ba Road, West Zone,

Fangshan Industrial Park, Fangshan District

110111 Beijing, China

(540)Madrid Application

**Nebe**

(511) 03

(210) No. M/1911417

(220) 31/12/2025

(732) Guangzhou Huichuang Cosmetics Co., Ltd.  
Room 403, No. 9, Hehui North Street, He  
Long Street, Baiyun District, Guangzhou City  
Guangdong Province, China

(540)Madrid Application

**TCZZ**

(511) 12

(210) No. M/1911422

(220) 31/12/2025

(732) Zhejiang Tongchang Foundry Co., Ltd.  
Bingang Industrial Zone, Shamen Town,  
Yuhuan County, Taizhou City Zhejiang  
Province, China

(540)Madrid Application

**LIANCHI WATER**

(511) 06, 11, 35 and 40

(210) No. M/1911424

(220) 29/12/2025

(732) Zhejiang Lianchi Water Equipment Co., Ltd.

No. 1208, Yuhangtang Road, Wuchang  
Street, Yuhang District in Hangzhou City  
Zhejiang Province, China

(540)Madrid Application



(511) 29

(210) No. M/1911427

(220) 25/02/2026

(732) Dongxing Zhongyuetai International Food  
Co., Ltd.

No. 002, Heng'er Road, Chonglan Industrial  
Park, Chonglan Village, Malu Town,  
Dongxing Guangxi Zhuang Autonomous  
Region, China

(540)Madrid Application



(511) 30

(210) No. M/1911429

(220) 25/02/2026

(732) Dongxing Zhongyuetai International Food Co., Ltd.

No. 002, Heng'er Road, Chonglan Industrial Park, Chonglan Village, Malu Town, Dongxing Guangxi Zhuang Autonomous Region, China

(540)Madrid Application

洛亚山川

(511) 10

(210) No. M/1911436

(220) 26/02/2026

(732) Beijing Luoya Shanchuan Medical Device Co.,Ltd.

Room1801, Unit 2, 15th floor, No.5 Building Jia, Shuanghuiyuan, Chaoyang District 100010 Beijing City, China

(540)Madrid Application

The logo for WAK features the letters 'WAK' in a bold, black, sans-serif font. A stylized white swoosh or underline is positioned beneath the 'W' and 'A', extending to the right and ending under the 'K'.

(511) 08 and 21

(210) No. M/1911535

(220) 04/12/2025

(732) NANJING RUIXUYI INTERNATIONAL  
TRADING CO.,LTD.

Room1701,1702,1703,1705,1707,1708,1709,  
Building B Changfa Center, No.300 East  
Zhongshan Road, Qinhuai District, Nanjing  
City 210002 Jiangsu Province, China

(540)Madrid Application

The logo for [e]STONE features the word 'STONE' in a bold, black, sans-serif font. The letter 'e' is enclosed in square brackets and is positioned to the left of 'STONE'.

(511) 19

(210) No. M/1911537

(220) 24/12/2025

(732) MARCOPOLO HOLDINGS CO., LTD

No.102 Gaobu Section, Beiwang Road,  
Gaobu Town, Dongguan City Guangdong  
Province, China

(540)Madrid Application

**LiberNovo**

(511) 09 and 20

(210) No. M/1911541

(220) 25/02/2026

(732) Qingxian Intelligent Innovation (Shenzhen)  
Co.,Ltd.

1501, East Tower, Lepu Building, No. 60  
Xingke Road, Xili Community, Xili Street,  
Nanshan District, Shenzhen City Guangdong  
Province, China

(540)Madrid Application

**YashanDB**

(511) 09 and 42

(210) No. M/1911546

(220) 26/02/2026

(732) Shenzhen Yashan Technology Co., Ltd.

1002, Building 9, Phase 2 of Hongshan 6979,  
Daling Community, Minzhi Subdistrict,  
Longhua District, Shenzhen City 518000  
Guangdong Province, China

(540)Madrid Application



(511) 07

(210) No. M/1911548

(220) 26/02/2026

(732) Yantai Jiwei Construction Machinery  
Equipment Co., Ltd.

No. 7, Inside No. 14, Zhuji Middle Road,  
Zhifu District, Yantai City Shandong  
Province, China

(540)Madrid Application

**Healmue**

(511) 10

(210) No. M/1911553

(220) 08/01/2026

(732) Zhejiang Hemu Medical Technology Co.,  
Ltd.

Room 914, Baiyuexuan, Changhe Street,  
Binjiang District, Hangzhou Zhejiang, China

(540)Madrid Application

**breamit**

(511) 09

(210) No. M/1911570

(220) 19/01/2026

(732) Shanghai Qinyun Electronic Technology Co.,  
Ltd.

Room 220, Building 5, No. 385 Yubei Road,  
Pudong New Area 201204 Shanghai, China

**ພາກທີ IV**  
**(Part IV)**

**ເຄື່ອງໝາຍການຄ້າຜ່ານລະບົບມາດຣິດ**  
**Trademarks via Madrid Protocol**

**2. ຜົນການຈົດທະບຽນ**  
**(Registration)**

**ຄຳອະທິບາຍກຽວກັບລະຫັດຫຍໍ້**  
**(Introduction of Codes)**

- (540) ເຄື່ອງໝາຍການຄ້າ (Trademark)
- (511) ໝວດ (Nice Classification)
- (210) ເລກທີ ຄຳຮ້ອງ (Number of the application)
- (220) ວັນທີ ຍື່ນຄຳຮ້ອງ (Date of filing of the application)
- (732) ຊື່ ແລະ ທີ່ຢູ່ ຂອງຜູ້ຍື່ນຄຳຮ້ອງ (Name and Address of applicant)
- (111) ເລກທີການຈົດທະບຽນເຄື່ອງໝາຍການຄ້າ (Number of the registration)
- (180) ວັນໝົດອາຍຸຂອງການຈົດທະບຽນ (Expiration date of the registration)

(540) Madrid Registration

AppGallery

(511) 09, 35, 36, 38, 41 and 42

(210) No. M/1524807

(220) 22/09/2020

(732) HUAWEI TECHNOLOGIES CO., LTD.

Administration Building Huawei

Technologies Co., Ltd., Bantian, Longgang

District Shenzhen, China

(111) No. M/1524807

(180) 14/01/2030

(540) Madrid Registration



(511) 43

(210) No. M/1855704

(220) 23/01/2025

(732) BERLIN'S DONER KEBAB

INTERNATIONAL PTE. LTD.

111 Somerset Road, #08-10A, 111 Somerset

Singapore 238164, Singapore

(111) No. M/1855704

(180) 23/01/2035

(540) Madrid Registration

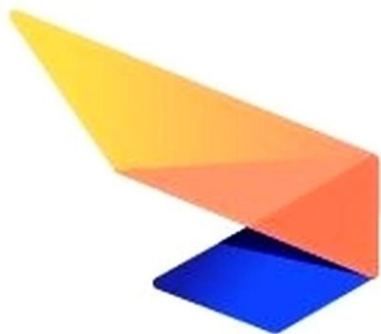

(511) 05

(210) No. M/1845213

(220) 15/05/2025

(732) TAIHO PHARMACEUTICAL CO., LTD.

1-27 Kandanishiki-cho, Chiyoda-ku Tokyo

101-8444, Japan

(111) No. M/1845213

(180) 23/01/2035

(540) Madrid Registration

**HISMILE**

(511) 03 and 21

(210) No. M/1847675

(220) 07/05/2025

(732) HISMILE IP PTY LTD

225 Burleigh Connection Road Burleigh

Waters QLD 4220, Australia

(111) No. M/1847675

(180) 14/02/2035

(540) Madrid Registration

**ICOTYDE**

(511) 05

(210) No. M/1849809

(220) 06/06/2025

(732) Janssen Pharmaceutica NV

Turnhoutseweg 30 B-2340 Beerse, Belgium

(111) No. M/1849809

(180) 20/03/2035

(540) Madrid Registration

**Fishin' Fire Lock  
Mania**

(511) 09, 28 and 41

(210) No. M/1857427

(220) 03/02/2025

(732) Euro Games Technology Ltd.

Panorama Sofia Str. 6, Richhill Business

Center, ground floor, Vitosha Region BG-1766

Sofia, Bulgaria

(111) No. M/1857427

(180) 03/02/2035

(540) Madrid Registration



(511) 09, 28 and 41

(210) No. M/1857477

(220) 15/01/2025

(732) EGT DIGITAL LTD.

"Panorama Sofia" Str. 6, Business Center

"Richhill", block A BG-1766 Sofia, Bulgaria

(111) No. M/1857477

(180) 15/01/2035

(540) Madrid Registration



(511) 03 and 42

(210) No. M/1857783

(220) 12/03/2025

(732) Guangzhou Yatsen Global Co., Ltd.

(Location: Room 1002-1015), Block B,

Zhongda Science and Technology Park, No.

135 Xingang West Road, Haizhu District,

Guangzhou City Guangdong Province, China

(111) No. M/1857783

(180) 12/03/2035

(540) Madrid Registration



(511) 32

(210) No. M/1857913

(220) 16/01/2025

(732) PT SARIGUNA PRIMATIRTA, Tbk.

JL. Raya A. Yani No. 41-43, Desa/ Kelurahan

Gedangan, Kec. Gedangan, Kabupaten

Sidoarjo Jawa Timur 61383, Indonesia

(111) No. M/1857913

(180) 16/01/2035

(540) Madrid Registration

**Kengee 仟吉**

(511) 30 and 43

(210) No. M/1858560

(220) 16/01/2025

(732) Wuhan Kengee Food Co., Ltd.

BinHu Branch Farm, Wuhu farm, Huangpi

District, Wuhan Hubei Province, China

(111) No. M/1858560

(180) 16/01/2035

(540) Madrid Registration



(511) 09, 28 and 41

(210) No. M/1858603

(220) 08/01/2025

(732) EGT DIGITAL LTD.

“Panorama Sofia” Str. 6., Business Center

“Richhill”, block A BG-1766 Sofia, Bulgaria

(111) No. M/1858603

(180) 08/01/2035

(540) Madrid Registration

**CENSTO**

(511) 03, 21 and 35

(210) No. M/1858659

(220) 20/03/2025

(732) XIAMEN POWERED BRAND

MANAGEMENT CO., LTD.

Room 401, 4th Floor, 227 Jinting North Road,

Jimei District, Xiamen City 361000 Fujian,

China

(111) No. M/1858659

(180) 20/03/2035

(540) Madrid Registration

The logo consists of the word "XEMIC" in a bold, black, sans-serif font.

(511) 07 and 09

(210) No. M/1858833

(220) 06/12/2024

(732) Xiangtan Electric Manufacturing Co., Ltd.

No. 302, Xiashesi Street, Xiangtan City

Hunan Province, China

(111) No. M/1858833

(180) 06/12/2034

(540) Madrid Registration



(511) 07 and 09

(210) No. M/1858834

(220) 06/12/2024

(732) Xiangtan Electric Manufacturing Co., Ltd.

No. 302, Xiashesi Street, Xiangtan City

Hunan Province, China

(111) No. M/1858834

(180) 06/12/2034

(540) Madrid Registration

**AFFA**

(511) 45

(210) No. M/1859083

(220) 03/01/2025

(732) PT. ARWANA FILMA FIRUSA

ANTAREJA

Graha Pratama Lt. 15 Jl. MT. Haryono Kav.

15, Kota Administrasi Jakarta Selatan DKI

Jakarta 12810, Indonesia

(111) No. M/1859083

(180) 03/01/2035

(540) Madrid Registration

**UMIOS**

(511) 01, 03, 05, 29, 30, 31 and 35

(210) No. M/1859337

(220) 13/03/2025

(732) Maruha Nichiro Corporation

2-20, 3-Chome, Toyosu, Koto-Ku Tokyo 135-

8608, Japan

(111) No. M/1859337

(180) 13/03/2035

(540) Madrid Registration

 **UNITRA**

(511) 09 and 11

(210) No. M/1859433

(220) 07/02/2025

(732) UNITRA SPÓŁKA Z OGRANICZONĄ  
ODPOWIEDZIALNOŚCIĄ

ul. Jana Czeczota 6 PL-02-607 Warszawa,  
Poland

(111) No. M/1859433

(180) 07/02/2035

(540) Madrid Registration



(511) 03

(210) No. M/1859438

(220) 18/04/2025

(732) HOUSE OF HUR KOREA INC

B1410-A-ho, 14F, 150, Yeongdeungpo-ro,  
Yeongdeungpo-gu Seoul, Republic of Korea

(111) No. M/1859438

(180) 18/04/2035

(540) Madrid Registration



(511) 29

(210) No. M/1859658

(220) 27/01/2025

(732) Cofco Agri-Industries Management Co., Ltd.

Room 1223, Tower A, Cofco Plaza No. 8,

Jianguomennei Ave., Dongcheng District

100015 Beijing, China

(111) No. M/1859658

(180) 27/01/2035

(540) Madrid Registration

**BySence**

(511) 28

(210) No. M/1859697

(220) 06/05/2025

(732) Longbohang (Hangzhou) Technology Co., Ltd.

Room 704-1, Building 4, Wangqiantang Seal

Center, Xiasha Street, Qiantang District

Hangzhou City 310000 Zhejiang Province,

China

(111) No. M/1859697

(180) 06/05/2035

(540) Madrid Registration



(511) 11

(210) No. M/1859759

(220) 08/12/2024

(732) Ningbo Luckboil Electrical Co., Ltd.

West end Hengfeng Road, Fangqiao

Industrial Zone, Fangqiao Street, Fenghua,

Ningbo Zhejiang, China

(111) No. M/1859759

(180) 08/12/2034

(540) Madrid Registration

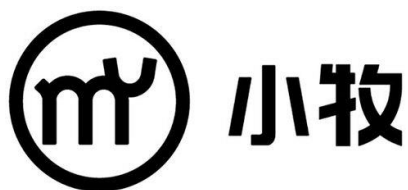

(511) 11, 20 and 21

(210) No. M/1859768

(220) 07/01/2025

(732) JOMOO Kitchen & Bath CO., LTD

Jomoo Industrial Park, Nanan Economic

Development Zone Fujian, China

(111) No. M/1859768

(180) 07/01/2035

(540) Madrid Registration

**Xanh4Biz**

(511) 09 and 39

(210) No. M/1859769

(220) 20/02/2025

(732) GSM Green and Smart Mobility Joint Stock  
Company

Symphony Office Tower, Chu Huy Man

Street, Vinhomes Riverside Urban Area, Phuc

Loi Ward, Long Bien District Hanoi City,

Vietnam

(111) No. M/1859769

(180) 20/02/2035

(540) Madrid Registration

**Tài xê Xanh 2.0**

(511) 09 and 39

(210) No. M/1859770

(220) 20/02/2025

(732) GSM Green and Smart Mobility Joint Stock  
Company

Symphony Office Tower, Chu Huy Man Street,

Vinhomes Riverside Urban Area, Phuc Loi

Ward, Long Bien District Hanoi City, Vietnam

(111) No. M/1859770

(180) 20/02/2035

(540) Madrid Registration

**LAGEE**

(511) 03

(210) No. M/1859788

(220) 27/03/2025

(732) Shanghai Nageer Technology Co., Ltd.

Room 1284, Building 2, No. 228,

Nonggongshang Avenue, Haiwan Town,

Fengxian District Shanghai, China

(111) No. M/1859788

(180) 27/03/2035

(540) Madrid Registration

**Sword & Crown**

(511) 09, 28 and 41

(210) No. M/1859821

(220) 10/02/2025

(732) EGT DIGITAL LTD.

"Panorama Sofia" Str. 6, Business Center

"Richhill", block A BG-1766 Sofia, Bulgaria

(111) No. M/1859821

(180) 10/02/2035

(540) Madrid Registration

**AL BRONZO  
BARILLA**

(511) 30

(210) No. M/1859927

(220) 16/04/2025

(732) Barilla G. e R. Fratelli - Societa per Azioni

Via Mantova 166 I-43122 Parma PR, Italy

(111) No. M/1859927

(180) 16/04/2035

(540) Madrid Registration

**AITO**

(511) 09 and 12

(210) No. M/1859975

(220) 13/03/2025

(732) Seres Auto Co., Ltd.

229 Fusheng Avenue, Jiangbei District

Chongqing, China

(111) No. M/1859975

(180) 13/03/2035

(540) Madrid Registration



(511) 09 and 12

(210) No. M/1860275

(220) 20/12/2024

(732) Segway Inc.

14 Technology Drive Bedford NH 03110,  
United States of America

(111) No. M/1860275

(180) 20/12/2034

(540) Madrid Registration

**BLUEPRINT BRYAN  
JOHNSON**

(511) 43

(210) No. M/1860466

(220) 27/01/2025

(732) Continuance LLC

5042 Wilshire Blvd. #26878 Los Angeles CA  
90036, United States of America

(111) No. M/1860466

(180) 27/01/2035

(540) Madrid Registration



(511) 01, 02, 03, 04, 05, 09, 16, 17, 19, 37, 41 and  
42

(210) No. M/1860640

(220) 03/02/2025

(732) Henkel AG & Co. KGaA

Henkelstrasse 67 40589 Düsseldorf, Germany

(111) No. M/1860640

(180) 03/02/2035

(540) Madrid Registration



(511) 12

(210) No. M/1860660

(220) 21/02/2025

(732) HO KHAC HUNG

30-32 LANG YEN, PHUONG BACH

DANG, QUAN HAI BA TRUNG THANH

PHO HA NOI, VIETNAM

(111) No. M/1860660

(180) 21/02/2035

(540) Madrid Registration



(511) 30

(210) No. M/1860719

(220) 19/02/2025

(732) TRUNG NGUYEN INVESTMENT  
CORPORATION

82-84 Bui Thi Xuan Street, Ben Thanh Ward,  
District 1 Ho Chi Minh City, Vietnam

(111) No. M/1860719

(180) 19/02/2035

(540) Madrid Registration



(511) 35

(210) No. M/1860896

(220) 18/12/2024

(732) SJT EXPORT AND IMPORT PTE. LTD.  
7 SOON LEE STREET, #03-17 ISPACE  
SINGAPORE 627608, SINGAPORE

(111) No. M/1860896

(180) 18/12/2034

(540) Madrid Registration

***HAN'S LASER***

(511) 07, 09 and 11

(210) No. M/1861036

(220) 05/02/2025

(732) Han's Laser Technology Industry Group Co.,  
Ltd.

No. 9988 Shennan Avenue, Nanshan District,  
Shenzhen 518000 Guangdong, China

(111) No. M/1861036

(180) 05/02/2035

(540) Madrid Registration

**HONOR AccuTrack**

(511) 09

(210) No. M/1861038

(220) 11/02/2025

(732) Honor Device Co., Ltd.

Suite 3401, Unit A, Building 6, Shum Yip Sky  
Park, No. 8089, Hongli West Road,  
Xiangmihu Street, Futian District, Shenzhen  
518040 Guangdong, China

(111) No. M/1861038

(180) 11/02/2035

(540) Madrid Registration

**HENKEL**

(511) 01, 02, 03, 04, 05, 09, 16, 17, 19, 37, 41 and 42

(210) No. M/1861200

(220) 03/02/2025

(732) Henkel AG & Co. KGaA

Henkelstrasse 67 40589 Düsseldorf, Germany

(111) No. M/1861200

(180) 03/02/2035

(540) Madrid Registration

**SYMPARE**

(511) 01

(210) No. M/1861216

(220) 14/02/2025

(732) KL-Kepong Oleomas Sdn Bhd

Level 8, Menara KKK, No. 1 Jalan PJU 7/6

Mutiara Damansara, 47810 Petaling Jaya

Selangor, Malaysia

(111) No. M/1861216

(180) 14/02/2035

(540) Madrid Registration

**HOMEOS**

(511) 09 and 42

(210) No. M/1861275

(220) 17/04/2025

(732) Home Operations Suite LLC

251 Little Falls Drive Wilmington DE 19808,  
United States of America

(111) No. M/1861275

(180) 17/04/2035

(540) Madrid Registration



(511) 36

(210) No. M/1861516

(220) 07/02/2025

(732) CAPITAL ONE FINANCIAL  
CORPORATION

15000 Capital One Drive Richmond VA  
23238, United States of America

(111) No. M/1861516

(180) 07/02/2035

(540) Madrid Registration



(511) 09 and 12

(210) No. M/1861557

(220) 13/03/2025

(732) Seres Auto Co., Ltd.

229 Fusheng Avenue, Jiangbei District

Chongqing, China

(111) No. M/1861557

(180) 13/03/2035

(540) Madrid Registration



(511) 04

(210) No. M/1861653

(220) 21/01/2025

(732) Haferd Petroleum Energy (GuangDong) Co.,  
Ltd.

Dalingshan Lianping Cun Panshan Industrial  
Area, Dongguan Guangdong, China

(111) No. M/1861653

(180) 21/01/2035

**ພາກທີ IV**  
**(Part IV)**

**ເຄື່ອງໝາຍການຄ້າຜ່ານລະບົບມາດຣິດ**  
**Trademarks via Madrid Protocol**

**3. ຜົນການຕໍ່ອາຍຸ**  
**(Renewal)**

**ຄຳອະທິບາຍກ່ຽວກັບລະຫັດຫຍໍ້**  
**(Introduction of Codes)**

- (540) ເຄື່ອງໝາຍການຄ້າ (Trademark)
- (511) ໝວດ (Nice Classification)
- (210) ເລກທີ ຄຳຮ້ອງ (Number of the application)
- (220) ວັນທີ ຍື່ນຄຳຮ້ອງ (Date of filing of the application)
- (732) ຊື່ ແລະ ທີ່ຢູ່ ຂອງຜູ້ຍື່ນຄຳຮ້ອງ (Name and Address of applicant)
- (111) ເລກທີການຈົດທະບຽນເຄື່ອງໝາຍການຄ້າ (Number of the registration)
- (180) ການຕໍ່ອາຍຸຂອງການຈົດທະບຽນ (Expiration date of the renewal)

**ພາກທີ IV**

**(Part IV)**

**ເຄື່ອງໝາຍການຄ້າຜ່ານລະບົບມາດຣິດ**

**Trademarks via Madrid Protocol**

**4. ການປ່ຽນແປງ**

**(Changes)**

**ພາກທີ IV**

**(Part IV)**

**ເຄື່ອງໝາຍການຄ້າຜ່ານລະບົບມາດຣິດ**

**Trademarks via Madrid Protocol**

**5. ການດັດແກ້**

**(Amendments)**

**ພາກທີ V**  
**(Part V)**  
**ຖິ່ນກຳເນີດ**  
**Geographical Indications**

**1. ຄຳຮ້ອງ**  
**(Applications)**

**ພາກທີ V**  
**(Part V)**  
**ຖິ່ນກຳເນີດ**  
**Geographical Indications**

**2. ຜົນການຈົດທະບຽນ**  
**(Registration)**

**ພາກທີ V**  
**(Part V)**  
**ຖິ່ນກຳເນີດ**  
**Geographical Indications**

**2.1 ຜົນການຈົດທະບຽນ ຜ່ານລະບົບສາກົນ**  
**(Lisbon Registration)**

**ພາກທີ V**  
**(Part V)**  
**ຖິ່ນກຳເນີດ**  
**Geographical Indications**

**2.2 ຜົນການຈົດທະບຽນ ຊື່ຖິ່ນກຳເນີດສະເພາະ ຜ່ານລະບົບສາກົນ**  
**(Lisbon Appellation of Origin Registration)**

**ພາກທີ V**

**(Part V)**

**ຖິ່ນກຳເນີດ**

**Geographical Indications**

**3. ການປ່ຽນແປງ**

**(Changes)**

**ພາກທີ V**  
**(Part V)**  
**ຖິ່ນກຳເນີດ**  
**Geographical Indications**

**4. ການດັດແກ້**  
**(Amendments)**

**ພາກທີ VI**

**(Part VI)**

**ພັນພືດໃໝ່**

**New Plant Varieties**

**1. ຄໍາຮ້ອງ**

**(Applications)**

**ພາກທີ VI**

**(Part VI)**

**ພັນພືດໃໝ່**

**New Plant Varieties**

**2. ຜົນການຈັດທະບຽນ**

**(Registration)**

**ພາກທີ VI**  
**(Part VI)**

**ພັນພືດໃໝ່**  
**New Plant Varieties**

**3. ການປ່ຽນແປງ**  
**(Changes)**

**ພາກທີ VI**

**(Part VI)**

**ພັນພືດໃໝ່**

**New Plant Varieties**

**4. ການດັດແກ້**

**(Amendments)**

**ພາກທີ VII**

**(Part VII)**

**ລິຂະສິດ ແລະ ສິດກ່ຽວຂ້ອງກັບລິຂະສິດ**

**Copyrights and Related Rights**

**1. ການແຈ້ງຂໍ້ມູນ**

**(Notifications)**

**ພາກທີ VII**

**(Part VII)**

**ລິຂະສິດ ແລະ ສິດກ່ຽວຂ້ອງກັບລິຂະສິດ**

**Copyrights and Related Rights**

**2. ການປ່ຽນແປງ**

**(Changes)**

**ພາກທີ VIII**

**(Part VIII)**

**ການແກ້ໄຂຂໍ້ຂັດແຍ່ງທາງດ້ານບໍລິຫານກ່ຽວກັບການຈົດທະບຽນຊັບ  
ສິນອຸດສາຫະກຳ ແລະ ພັນພືດໃໝ່**

**Administrative Dispute Resolutions on the Registration of  
Industrial Property and New Plant Varieties**

**1. ຜົນການຄັດຄ້ານຄຳຮ້ອງ**

**(Result of Oppositions)**

**ພາກທີ VIII**

**(Part VIII)**

**ການແກ້ໄຂຂໍ້ຂັດແຍ່ງທາງດ້ານບໍລິຫານກ່ຽວກັບການຈົດທະບຽນຊັບ  
ສິນອຸດສາຫະກຳ ແລະ ພັນພືດໃໝ່**

**Administrative Dispute Resolutions on the Registration of  
Industrial Property and New Plant Varieties**

**2. ຜົນການແຈ້ງປະຕິເສດ**

**(Result of Refusals)**

**ພາກທີ VIII**

**(Part VIII)**

**ການແກ້ໄຂຂໍ້ຂັດແຍ່ງທາງດ້ານບໍລິຫານກ່ຽວກັບການຈົດທະບຽນຊັບ**

**ສິນອຸດສາຫະກຳ ແລະ ພັນພືດໃໝ່**

**Administrative Dispute Resolutions on the Registration of  
Industrial Property and New Plant Varieties**

**3. ຜົນການຍົກເລີກ ຫຼື ລົບລ້າງ ຂອງການຈົດທະບຽນ**

**(Result of Cancellation or Invalidation of Registration)**