



ສາທາລະນະລັດ ປະຊາທິປະໄຕ ປະຊາຊົນລາວ
LAO PEOPLE'S DEMOCRATIC REPUBLIC

ກະຊວງ ອຸດສາຫະກຳ ແລະ ການຄ້າ
ກົມຊັບສິນທາງປັນຍາ
MINISTRY OF INDUSTRY AND COMMERCE
DEPARTMENT OF INTELLECTUAL PROPERTY

ຈົດໝາຍເຫດທາງລັດຖະການ
ກ່ຽວກັບ ຊັບສິນທາງປັນຍາ
ຢູ່ ສປປ ລາວ

OFFICIAL GAZETTE ON INTELLECTUAL PROPERTY
IN LAO PDR

ສະບັບທີ (Vol.) 355

ພາກທີ I

(Part I)

ສິດທິບັດ ແລະ ອະນຸສິດທິບັດ (Patent and Petty Patent)

1. ຄໍາຮ້ອງ (Applications)

ຄໍາອະທິບາຍກ່ຽວກັບລະຫັດຫຍໍ້ (Introduction of Codes)

- (21) ເລກທີ ຄໍາຮ້ອງ (Filing Number)
- (22) ວັນທີ ຍືນຄໍາຮ້ອງ (Filing Date)
- (30) ວັນທີ ບຸລິມະສິດ (Priority Date)
- (43) ວັນທີເຜີຍແຜ່ (Publication Date)
- (51) ໝວດ (International Patent Classification)
- (54) ຊື່ຂອງການປະດິດ (Title)
- (57) ບົດຄັດຫຍໍ້ (Abstract)
- (71) ຊື່ ແລະ ທີ່ຢູ່ ເຈົ້າຂອງສິດທິບັດ ແລະ ອະນຸສິດທິບັດ (Owner Name and Address)
- (72) ຊື່ຜູ້ປະດິດ (Inventor Name)
- (74) ຊື່ຕົວແທນ (Representative Name)
- (55) ຮູບພາບ (Pictures)

Official Gazette of Industrial Property Vol. 355, 08/05/2026

- (21) No. PT 522
- (22) 14/07/2017
- (30) 15/006,994 26/01/2016 US; 62/108,491 27/01/2015 US and PCT/US2016/015129 27/01/2016 US
- (43)
- (51) Int.Cl.H 04N 19/105, H 04N 19/593, H 04N 19/463, H 04N 19/186
- (54) ADAPTIVE CROSS COMPONENT RESIDUAL PREDICTION
- (57) A system and method for encoding and decoding video data. A predicted residual signal of a target color component is determined as a function of one or more linear parameters of a linear model and of a residual signal of a source color component. A residual signal of the target color component is determined as a function of a remaining residual signal of the target color component and of the predicted residual signal of the target color component..
- (71) QUALCOMM INCORPORATED
Attn: International IP Administration 5775 Morehouse Drive San Diego, California 92121-1714 , United States of America.
- (72) LI, Xiang; CHEN, Jianle; KARCZEWICZ, Marta; LIU, Hongbin; CHEN, Ying; ZHANG, Li and ZHAO, Xin.
- (74) CONCETTI-LAO CO., LTD.
- (55)

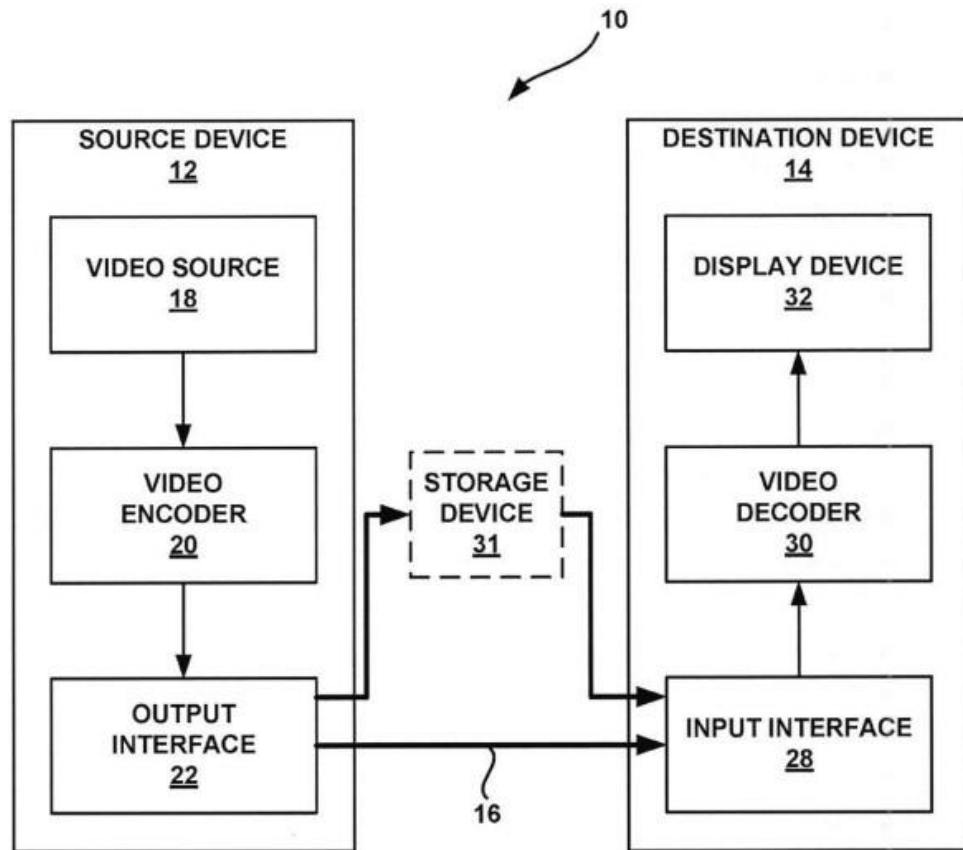
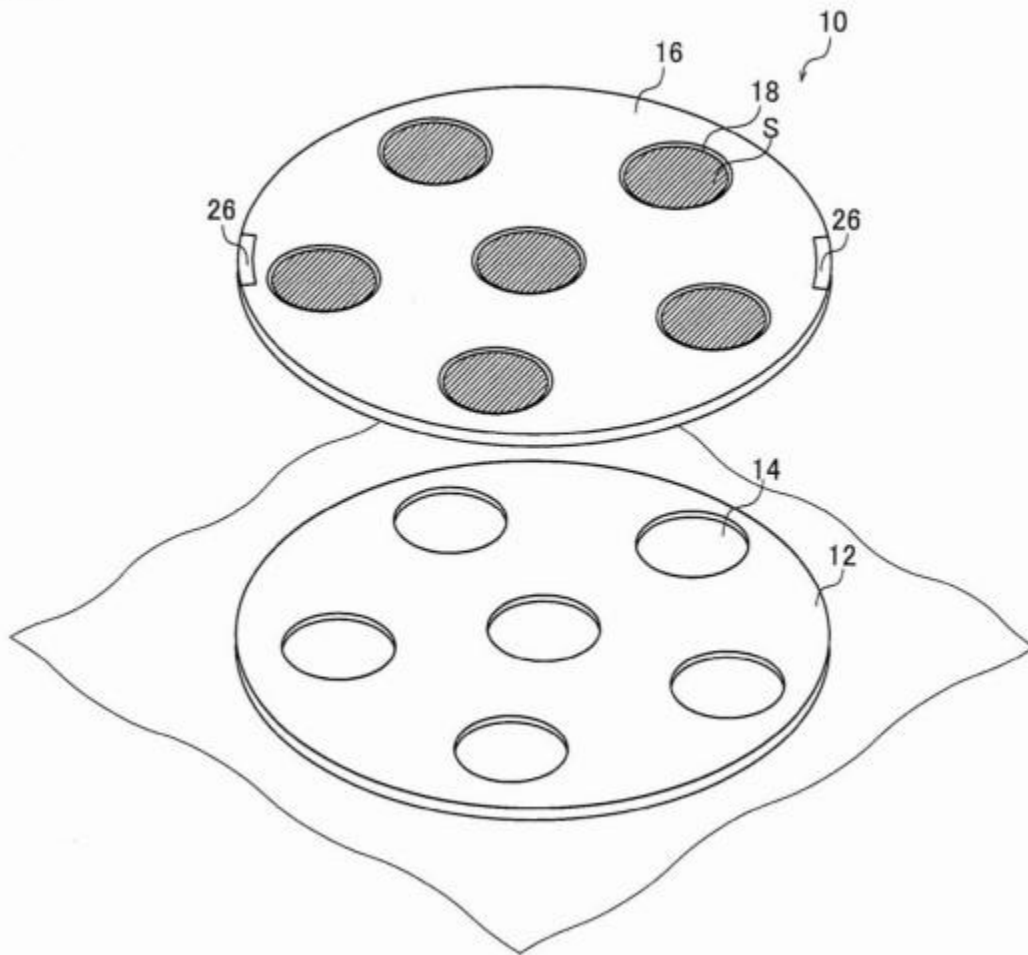

FIG. 1

- (21) No. PT 831
- (22) 20/04/2022
- (30) 1-2019-05355 30/09/2019 VN
- (43)
- (51) Int.Cl.B 24B 37/34(2012.01), B 24B 37/28(2012.01)
- (54) ຕົວຈິກ (Jip) ຊ່ວຍວາງຕໍາແໜ່ງຊັບສເຕຣດ ແລະ ວິທີການຜະລິດຊັບສເຕຣດ
- (57) ຈໍານວນຮູ້ທີ່ກຽມພ້ອມທີ່ຈັດໃຫ້ມີ ໂດຍສອດຄ່ອງສໍາພັນກັນກັບຕໍາແໜ່ງຂອງຫຼາຍຈໍານວນຮູ້ຍຶດຖືຊັບສເຕຣດ ໃນຕົວພາທີ່ມີຫຼາຍຈໍານວນຮູ້ກຽມພ້ອມ ທີ່ຖືກຈັດໃຫ້ມີໂດຍສອດຄ່ອງສໍາພັນກັນກັບຕໍາແໜ່ງຂອງຫຼາຍຈໍານວນ ຮູ້ຍຶດຖືຊັບສເຕຣດໃນຕົວພາ ແລະ ຊຶ່ງຊັບສເຕຣດສາມາດຖືກຈັດວາງໄດ້; ແລະ ສັດສ່ວນກົງເລັບທີ່ຍື່ນ ອອກມາຈາກຢ່າງໜ້ອຍທີ່ສຸດ ໜຶ່ງຕໍ່ າ ແ ໜ່ ງ ເທິ ງ ຂ ອ ບ ຂ ອ ງ ແ ຕ່ ລ ະ ຮູ ກ ຽ ມ ພ້ ອ ມ ແ ລ ະ ຍື ກ ຖື ຊັ ບ ສ ເ ຕ ຣ ດ ໃນຂະນະທີ່ສໍາຜັດກັບສິ້ນສຸດວົງມົນຮອບນອກຂອງຊັບສເຕຣດ. ໃນສະພາບຊຶ່ງຊັບສເຕຣດຖືກຍຶດຖື ຕາມລໍາດັບໃນ ຮູ ກ ຽ ມ ພ້ ອ ມ ຊຶ່ງເປັນຜົນຂອງສັດສ່ວນຂອງກົງເລັບ ເປັນສາເຫດໃຫ້ມີການຍື່ນອອກມາ, ໂຄງຮ່າງຫຼັກຂອງຕົວຈິກຖືກເຄື່ອນຍ້າຍໄປຍັງຕໍາແໜ່ງດ້ານເທິງຕົວພາ ແລະ ສັດສ່ວນກົງເລັບຖືກຖອນກັບເພື່ອປ່ອຍຊັບສເຕຣດ ຈາກຮູກຽມພ້ອມຕາມລະດັບ ແລະ ເປັນສາເຫດເຮັດໃຫ້ຊັບສເຕຣດຕົກລົງ ແລະ ຖືກຈັດວາງຕາມລໍາດັບໃນຮູ້ຍຶດຖືຊັບສເຕຣດ ໃນຕົວພາທີ່ຢູ່ເບື້ອງລຸ່ມ.
- (71) HOYA CORPORATION 6-10-1 Nishi-Shinjuku, Shinjuku-ku, Tokyo 1608347, Japan.
- (72) SRITEP, Wuttipong and KUNALINTIP, Voravut.
- (74) Tilleke & Gibbins Lao Co.,Ltd.
- (55)

[圖1]



Official Gazette of Industrial Property Vol. 355, 08/05/2026

- (21) No. PT 842
- (22) 11/08/2022
- (30) 202010127193.2 28/02/2020 CN
- (43)
- (51) Int.C1.0B 62J 50/22(2020.01), B 62J 45/00(2020.01)
- (54) EARLY-WARNING SYSTEM, METHOD, AND APPARATUS FOR STEERING OF TWO WHEELED VEHICLE, AND CORRESPONDING TWO-WHEELED VEHICLE
- (57) Disclosed are an early-warning system, method, and apparatus for steering of a two-wheeled vehicle, and a corresponding two-wheeled vehicle, the two-wheeled vehicle including a display apparatus. The system includes: a first control system and a second control system both operating independently and capable of exchanging data between each other in real time; the first control system is configured to: monitor a steering state of the two-wheeled vehicle in real time and generate steering state data; generate early-warning state data based on the steering state data; transmit at least part of the steering state data and the early-warning state data to the second control system in real time; and control corresponding components of the two-wheeled vehicle to operate according to control instructions received from the second control system and internal preset instructions; and the second control system is configured to: receive the steering state data and the early-warning state data transmitted by the first control system; generate early-warning information based on the early-warning state data, and control a display of the display apparatus based on the steering state data and/or the early-warning information. The present application can give an early warning to a driver when steering the two-wheeled vehicle, to accurately provide the driver with a safe operation prompt, to improve the user's driving safety and enhance the user experience..
- (71) SHARKGULF TECHNOLOGY (QINGDAO) CO., LTD.
Room 8206-1-4 (A), 2F, Qiantongyuan Office Building, No. 44 Moscow Road, Qianwan Bonded Port Area, Qingdao Area, China (Shandong) Pilot Free Trade Zone Qingdao, Shandong 266000, China.
- (72) LIU, Ke; HU, Hui; LIU, Shiyao and LI, Peng.
- (74) CONCETTI - LAO CO., LTD.
- (55)

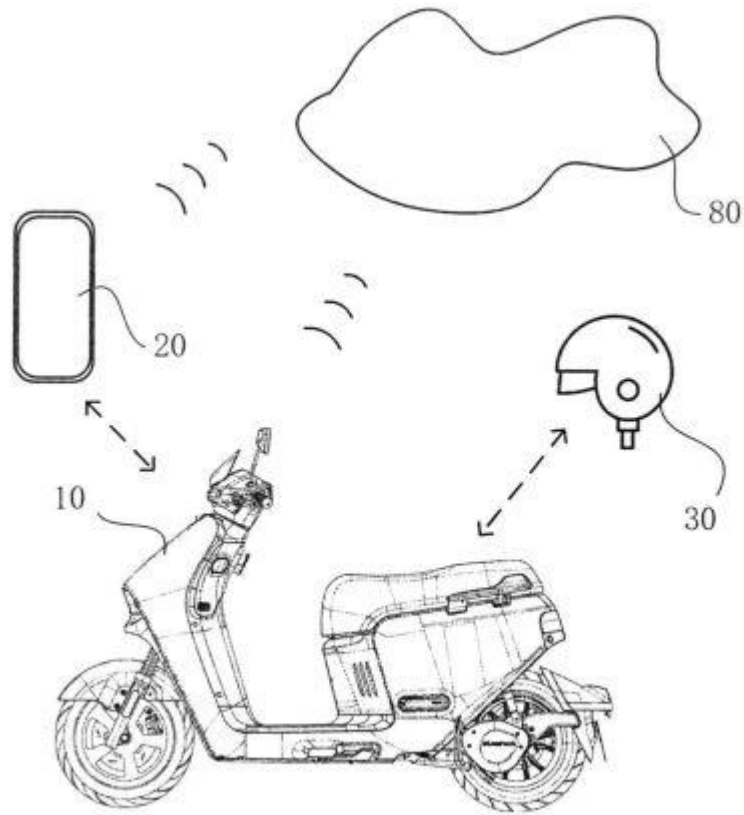

FIG. 1

Official Gazette of Industrial Property Vol. 355, 08/05/2026

- (21) No. PT 883
- (22) 13/01/2023
- (30) 20183134.4 30/06/2020 DK
- (43)
- (51) Int.Cl.2018.01C 12C 12/00(2006.01), C 12R 1/86(2006.01)
- (54) Low diacetyl yeast
- (57) The present invention relates to yeast strains of the species *Saccharomyces pastorianus* with the useful characteristic of producing low levels of diacetyl during fermentation. Also provided are methods of producing a malt and/or cereal based beverage with these strains, as well as beverages produced by this method..
- (71) Carlsberg A/S
J.C. Jacobsens Gade 1,1799, Copenhagen V, Denmark, Denmark.
- (72) Klaus Lengeler; Michael Katz; Jochen Forster ; Ross Fennessy; Claes Gjermansen and Anna Chailyan.
- (74) Ageless Lao Sole Co. Ltd.
- (55)

Fig. 1

A)

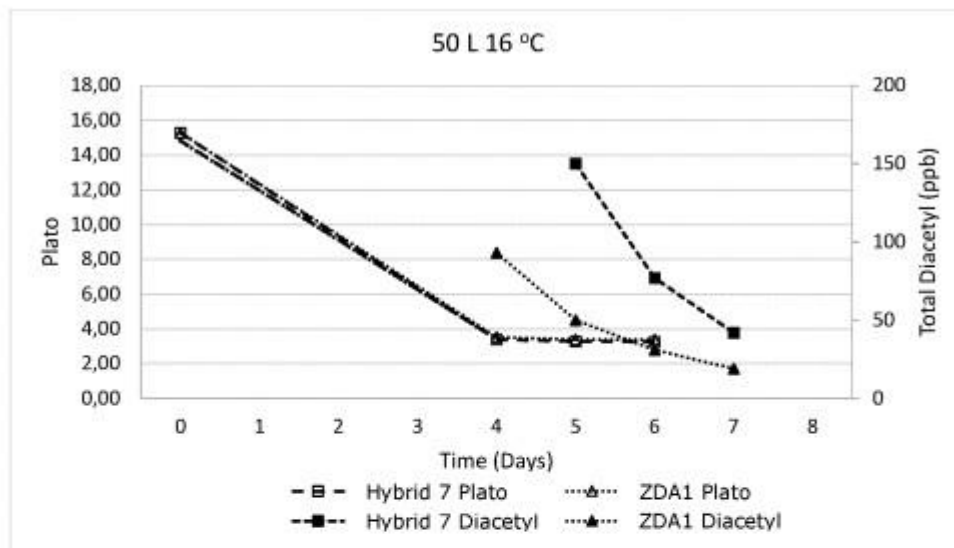

B)

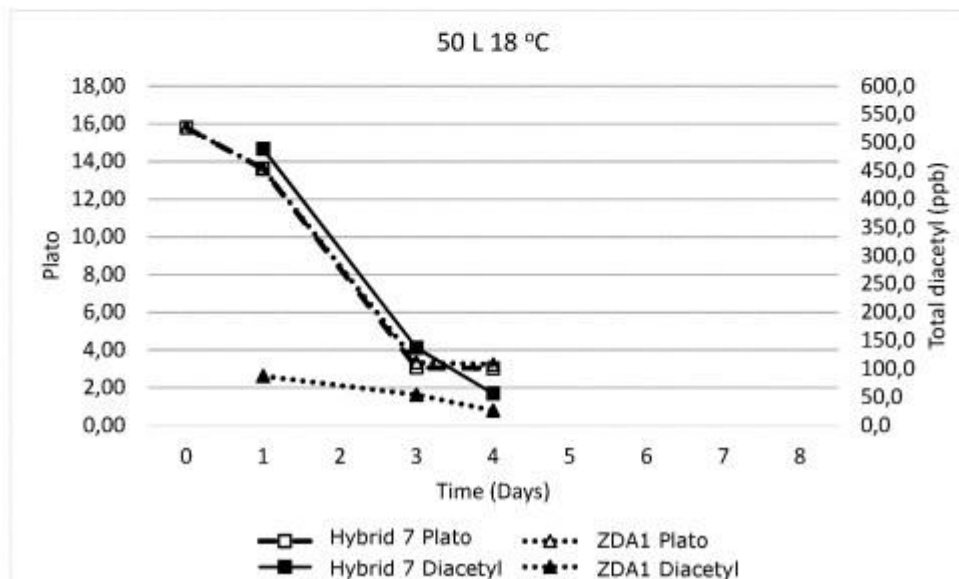

Official Gazette of Industrial Property Vol. 355, 08/05/2026

- (21) No. PT 893
- (22) 11/04/2023
- (30) 1020200118655 15/09/2020 KR
- (43)
- (51) Int.Cl.2018.01C 12N 5/0783(2010.01), A 61K 35/17(2015.01), A 61K 48/00(2006.01), A 61P 35/00(2006.01)
- (54) ວິທີການກະກຽມຕົວຂ້າເຊລຕາມທຳມະຊາດທີ່ມີຄວາມບໍລິສຸດສູງດ້ວຍປະສິດທິພາບສູງ ແລະ ການນຳໃຊ້ເຊວດັ່ງກ່າວ
- (57) ການປະດິດສ້າງແມ່ນກ່ຽວຂ້ອງກັບວິທີການສຳລັບການກະກຽມຕົວຂ້າເຊລຕາມທຳມະຊາດ ທີ່ມີຄວາມບໍລິສຸດສູງ (ເຊວ NK) ທີ່ມີປະສິດທິພາບສູງ ແລະ ໂດຍສະເພາະ, ອົງປະກອບສຳລັບການເພີ່ມຕົວຂະໜາຍ ແລະ ການກະຖຸນຂອງເຊວ NK ແລະ ວິທີການສຳລັບການກະກຽມເຊວ NK ທີ່ມີການປັບປຸງການຂະໜາຍຜົນ ແລະ ການເປີດໃຊ້ງານ. ຕົ້ນກິນການກະກຽມເຊວ NK ອີງຕາມການປະດິດນີ້ແມ່ນເຮັດໃຫ້ເຊວNK ທີ່ມີຄວາມບໍລິສຸດສູງໄດ້ຮັບປະສິດທິພາບສູງ, ແລະ NK ກະກຽມ ໂດຍວິທີການອື່ນຕາມການ. ການປະດິດນີ້ແມ່ນສາມາດຖືກນຳໃຊ້ຢ່າງມີປະສິດທິພາບ ໃນດ້ານການປົ່ນປົວພະຍາດ ເຊັ່ນ: ມະເຮັງ ແລະ ພະຍາດແຜ່ພູມຕົວເອງ ບົນຜູ້ນຳທີ່ມີຄວາມບໍລິສຸດສູງ ແລະ ຄວາມສາມາດໃນການຂ້າມະເຮັງທີ່ດີເລີດ.
- (71) TS BIO CO., LTD.
702, 7F., 272 Digital-ro, Guro-gu, Seoul 08389, Republic of Korea.
- (72) YIM, Cha Ok.
- (74) ACTIP (LAO) IP CO, LTD..
- (55)

DRAWINGS

FIG. 1

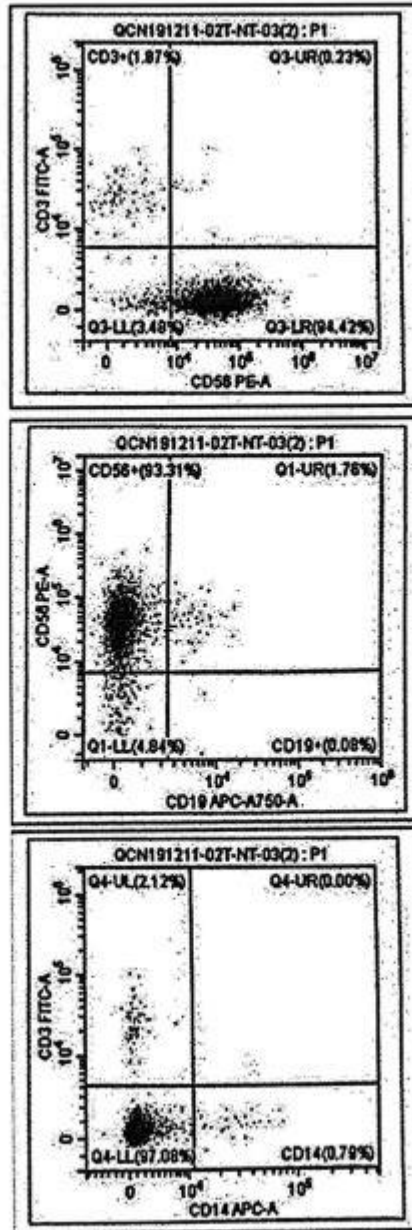

- (21) No. PT 942
- (22) 02/02/2024
- (30) 202311516321.2 14/11/2023 CN
- (43)
- (51) Int.Cl.2018.01E 21C 27/44(2006.01)
- (54) MINING MILLING APPARATUS, VERTICAL MINING MACHINES AND VERTICAL MINING METHODS
- (57) The present disclosure relates to a mining milling apparatus, which comprises a plurality of milling rotors (10,20,30,40), wherein the milling rotors are arranged at intervals along a first direction; each milling rotor comprises a rotatable milling drum (11) and a plurality of cutting teeth (12) spirally arranged on the axial periphery of the milling drum (11); the plurality of milling rotors (10,20,30,40) are configured for excavating in a stratum to be excavated along a second direction, wherein the first direction and the second direction are substantially vertical; the present disclosure further includes a vertical mining machine and a vertical mining method.
- (71) JIANGSU XCMG CONSTRUCTION MACHINERY RESEARCH INSTITUTE LTD.
NO.26, TUOLANSHAN ROAD, ECONOMIC DEVELOPMENT ZONE, XUZHOU,
JIANGSU 221004, CHINA
XUZHOU XUGONG FOUNDATION CONSTRUCTION MACHINERY CO., LTD
NO.1, XUGONG AVENUE, QINGSHANQUAN TOWN, JIA WANG DISTRICT,
XUZHOU, JIANGSU, CHINA.
- (72) JIA, Haibo ; CHEN, Xinchun ; LU, Zhijun and LUO, Ju.
- (74) LAO TRADEMARK AGENCY (LAO IP AGENCY).
- (55)

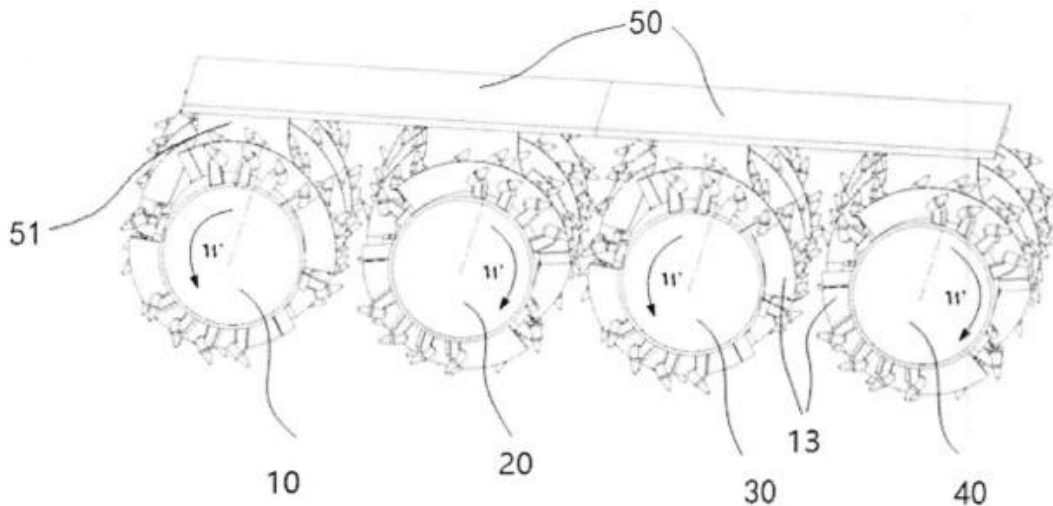

FIG 1

(21) No. PT 944

(22) 06/03/2024

(30)

(43)

(51) Int.Cl.2018.01E 03B 3/02(2006.01), E 03F 5/10(2006.01)

(54) HIGH-STRENGTH ROAD FOR WATER RESOTIRCE REGULATION SYSTEM IN RESPONSE TO CLIMATE CHANGE

(57) A high-strength road for a water resource regulation system in response to climate change. An underground structural space (30) is formed by a structural system formwork (31), which is provided with a hollow unit body (30a), by means of grouting and solidiffing concrete grout (302), and the high-strength road is formed by paving a road or a pavement (10) over the underground structural space (30). The hollow unit body (30a) is at least provided with a sffuctural formwork (31) and is formed by means of combining a plurality of side slabs (32). An upper surface of the formwork (31) is provided with a plate (312), which is provided with a through hole (311) and at least one through pipe (33). After the structural system formwork (31) and the side slabs (312) arecombined, the concrete grout (302) is grouted and solidifies to form the underground structural space (30) with a high support strength.

(71) CHEN, Jui-Wen

No. 23, Ln.123, Junying St., Shulin Dist. New Taipei City, Taiwan 238, Taiwan.

(72) CHEN, Jui-Wen.

(74) CONCETTI-LAO CO., LTD.

(55)

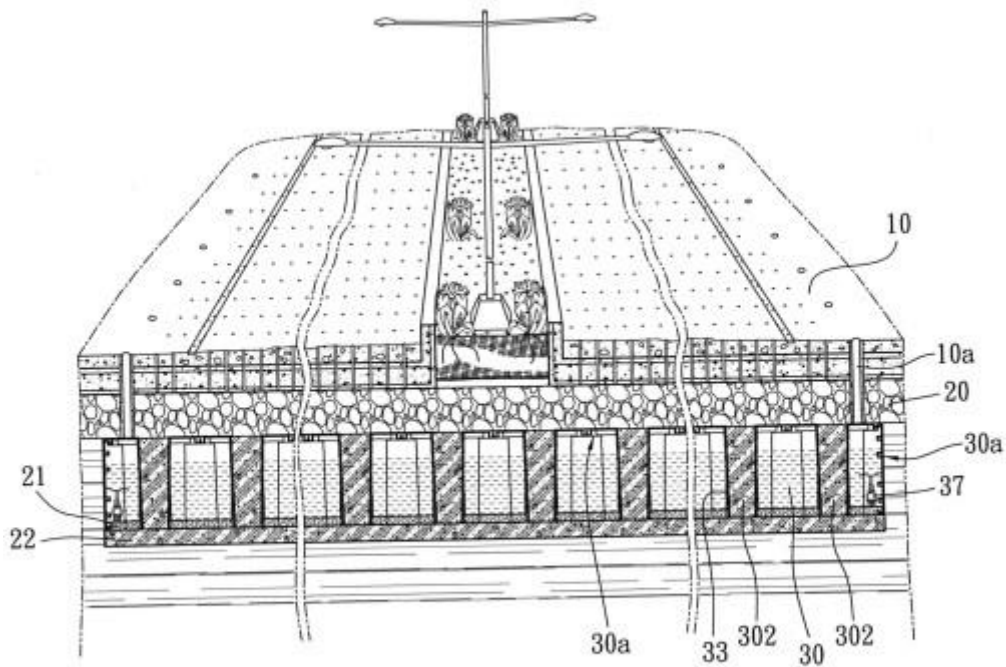

FIG. 1

- (21) No. PT 946
- (22) 28/03/2024
- (30) 11202100574V 26/07/2019 SG; 62/703,521 26/07/2018 US and 62/856,826 04/06/2016 US
- (43)
- (51) Int.Cl.2018.01B 63B 9/06(2006.01), B 63B 35/34(2006.01)
- (54) ໂຄງສ້າງຮູບແບບຜູ້ນໍ້າ ແລະ ວິທີການຂອງການກໍ່ສ້າງ
- (57) ດິນແດນຂົງເຂດຜູ້ນໍ້າໜຶ່ງແມ່ນໄດ້ເຮັດຈາກຢ່າງນ້ອຍສອງສ່ວນປະກອບກໍ່ສ້າງຜູ້ນໍ້າມີຮູບຮ່າງຂອງ ແກ້ວເຈັດສີໜຶ່ງ ດ້ວຍພື້ນຖານຮູບຫຼາຍລ່ຽມປົກກະຕິໜຶ່ງ, ເຊັ່ນວ່າ ຮູບສາມແຈໜຶ່ງ, ຮູບຈະຕຸລັດໜຶ່ງ, ຮູບຫ້າແຈໜຶ່ງຮູບ, ຮູບຫົກແຈໜຶ່ງ, ແລະ ອື່ນໆ ຖືກປະສົມປະສານດ້ວຍການເລື່ອນເຊື່ອມເຂົ້າຫາກັນ ແລະ ຮ່ອງເຊື່ອມເຂົ້າຫາກັນສໍາລັບການເລື່ອນແຊກຫາ ອົງປະກອບກໍ່ສ້າງໃກ້ຄຽງ. ຕົວແຊກອະນຸຍາດສ່ວນປະກອບກໍ່ສ້າງຜູ້ນໍ້າ ເພື່ອເລື່ອນໂດຍທາງຕັ້ງພົວພັນເຊິ່ງກັນ ແລະ ກັນ, ດັ່ງນັ້ນ ການອະນຸຍາດດິນແດນຂົງເຂດຜູ້ນໍ້າເພື່ອຕິດຕາມການເຄື່ອນຍ້າຍຂຶ້ນເທິງ ແລະ ລົງລຸ່ມຂອງຄື້ນ. ວິທີການໜຶ່ງຂອງການຫັນປ່ຽນ ເສດເຫຼືອມະຫາສະໝຸດ ຜູ້ນໍ້າໄປປັບໂຄງສ້າງ, ໂດຍສະເພາະ, ດິນແດນຂົງເຂດຜູ້ນໍ້າແມ່ນຖືກສະໜອງພ້ອມກັນ.
- (71) Legacy Foundry AG
Genferstrasse 21, Zürich, CH-8002 Switzerland, Swaziland.
- (72) Lucien VOTILLAMOZ.
- (74) CONCETTI-LAO CO., LTD.
- (55)

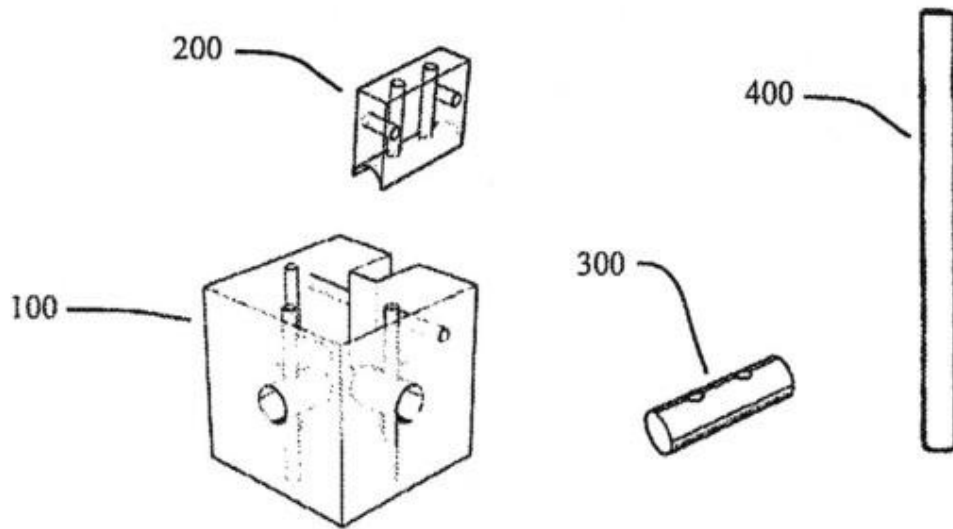

FIG. 1

Official Gazette of Industrial Property Vol. 355, 08/05/2026

- (21) No. PT 947
- (22) 28/03/2024
- (30) 202111407400.0 24/11/2021 CN
- (43)
- (51) Int.Cl.
- (54) ວິທີການສະທ້ອນກັບການປະຕິບັດການໜ້າເຄື່ອນຂ່າຍອັດສະລິຍະ, ລະບົບ ແລະ ຮູບແບບລະບົບ ແລະ ສື່ເກັບຮັກສາອ່ານໄດ້
- (57) ຖືກສະໜອງໃນການສະໜັບສະໜູນການເປີດເຜີຍ ແມ່ນວິທີການສະທ້ອນກັບ ການປະຕິບັດການໜ້າເຄື່ອນຂ່າຍອັດສະລິຍະໜຶ່ງ, ປະກອບດ້ວຍ; ການໄດ້ມາຂໍ້ມູນຂ່າວສານການປະຕິບັດການປະຈຸບັນຂອງຜູ້ຊົມໃຊ້ໜຶ່ງໃນການນຳໃຊ້ເຄື່ອນຂ່າຍນອກໜຶ່ງ, ໃນນັ້ນຂໍ້ມູນຂ່າວສານການ ປະຕິບັດການປະຈຸບັນປະກອບດ້ວຍ: ຕົວລະບຸຜູ້ຊົມໃຊ້ໜຶ່ງ, URL ບໍລິການໜຶ່ງ ແລະ ໜ້າຂໍ້ມູນທຸລະກິດ, ການຫັນປ່ຽນຂໍ້ມູນ ຂ່າວສານການປະຕິບັດການປະຈຸບັນໄປສູ່ຂໍ້ມູນລະດັບການປະຕິບັດປະຈຸບັນ, ດັ່ງເພື່ອປັບປຸງແກ້ໄຂທັນເວລາ, ໃນຂໍ້ມູນພື້ນຖານໜຶ່ງ, ຊຸດລຳດັບປະຕິບັດການໜຶ່ງຂອງຜູ້ຊົມໃຊ້. ໃນນັ້ນຊຸດລຳດັບ ການປະຕິບັດການປະກອບດ້ວຍຈຳນວນຫຼາຍໜຶ່ງຂອງຂໍ້ມູນລຳດັບການ ປະຕິບັດການຖືກຈັດວາງໃນວິທີການຈັດວາງລຳດັບ ຕາມເວລາໜຶ່ງ ແລະ ການສືບຕໍ່ການສະແດງ ບົດບາດເທິງຊຸດລຳດັບການປະຕິບັດ ການອີງຕາມເສັ້ນທາງປະຕິບັດການກຳນົດ ລ່ວງໜ້າໜຶ່ງ, ແລະ ເທິງເງື່ອນໄຂຂອງຜົນໄດ້ຮັບການສືບຕໍ່ໜຶ່ງ ຕອບສະໜອງ ກຳນົດລ່ວງ ໜ້າໜຶ່ງ, ການສົ່ງ, ເຖິງການ ນຳໃຊ້ເຄື່ອນຂ່າຍນອກ, ຂໍ້ມູນຂ່າວສານສະທ້ອນກັບສຳລັບການແຈ້ງເສັ້ນທາງປະຕິບັດການກຳນົດລ່ວງໜ້າ. ຕໍ່ໄປຖືກ ສະໜອງແມ່ນລະບົບໜຶ່ງແລະສື່ຄອມພິວເຕີເກັບຮັກສາອ່ານໄດ້ໜຶ່ງ. ດ້ວຍການນຳໃຊ້ວິທີການ, ຕົ້ນທຶນການຮຽນຮູ້ຂອງຜູ້ຊົມ ໃຊ້ໜຶ່ງລະຫວ່າງການນຳໃຊ້ຂອງລະບົບການນຳໃຊ້ເຄື່ອນຂ່າຍບໍລິການສັບຊ້ອນໜຶ່ງອາດແມ່ນຖືກຫຼຸດຜ່ອນຫຼວງຫຼາຍ, ດັ່ງນັ້ນ ປັບປຸງ ປະສິບການຜູ້ຊົມໃຊ້.
- (71) CHINA UNIONPAY CO., LTD.
CUP Tower,36 Hanxiao Rd., Pudong New Area Shanghai 200135, China.
- (72) CHEN, Lin; XU, Bin; WANG, DA; YIN, Jie and BAI, Huirong.
- (74) CONCETTI-LAO CO., LTD.
- (55)

100

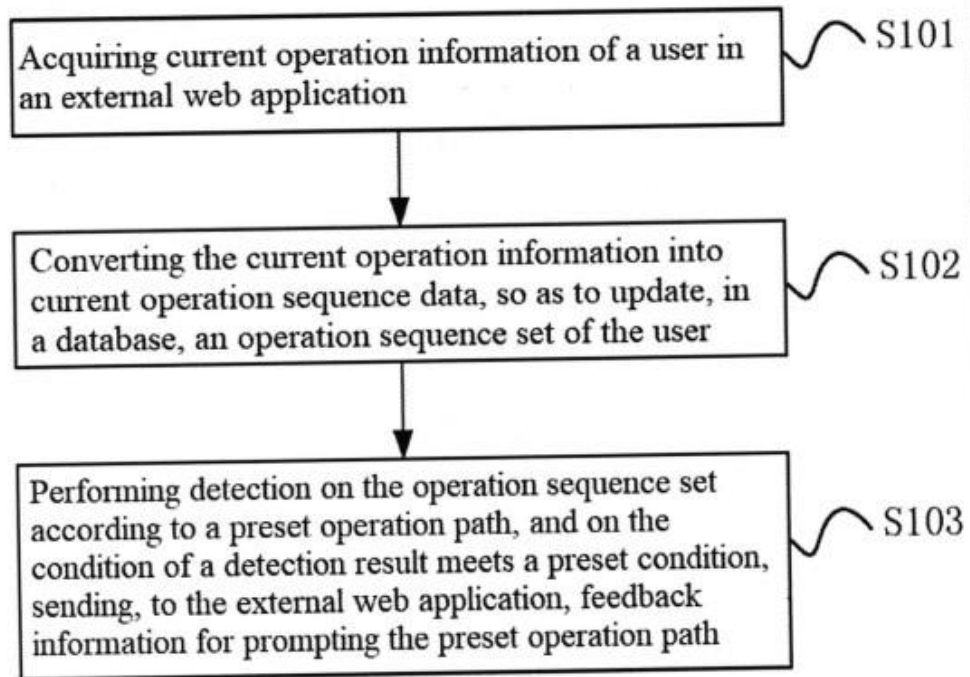
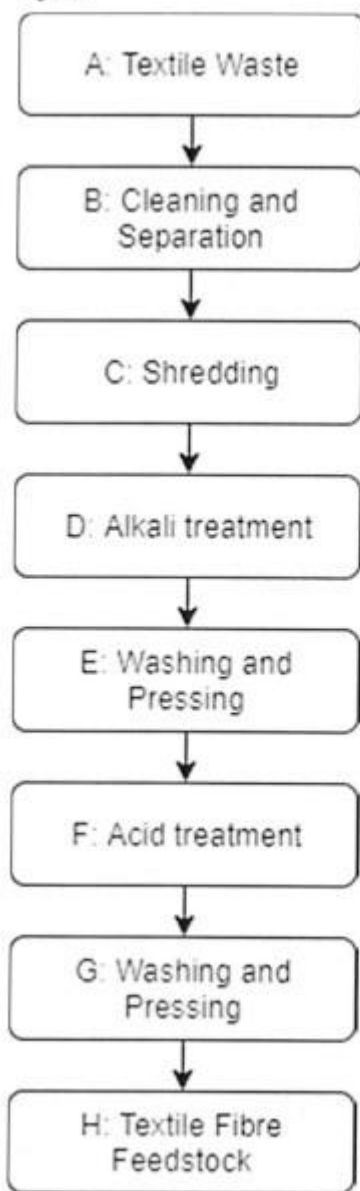

FIG. 1

Official Gazette of Industrial Property Vol. 355, 08/05/2026

- (21) No. PT 948
- (22) 01/04/2024
- (30)
- (43)
- (51) Int.Cl.2018.01C 08J 11/06(2006.01), C 08J 11/04(2006.01)
- (54) ວິທີການລິໄຊເຄິນສິ່ງເສດເຫຼືອແຜ່ນແພຂອງເຊລູໂລສ
- (57) ວິທີການນຳໃຊ້ຄືນເຊລູໂລສ ສິ່ງເສດເຫຼືອແຜ່ນແພ ການປະດິດປະຈຸບັນນີ້ສະໜອງວິທີການລິໄຊເຄິນເຊລູໂລສ ເພື່ອໃຊ້ເປັນອາຫານເສັ້ນໄຍສິ່ງທໍ, ວິທີການປະກອບມີ (i) ການສະໜອງອາຫານສິ່ງເສດເຫຼືອທີ່ປະກອບດ້ວຍ ເຊລູໂລສຫຼາຍກວ່າ 50 wt% ໂດຍນຳໜັກຂອງອາຫານສິ່ງເສດ ເຫຼືອ; (ii) ຖາດຖອນອາຫານສິ່ງເສດເຫຼືອຂອງສິ່ງ ເສດເຫຼືອເພື່ອສະໜອງສິ່ງເສດເຫຼືອ ຈາກສິ່ງເສດເຫຼືອຂອງອາຫານສິ່ງທໍ ທີ່ປະກອບດ້ວຍເສັ້ນໄຍທີ່ມີຄວາມຍາວ ຂອງເສັ້ນໃຍຕໍ່າກວ່າ 5 ມມ; (iii) ປະສົມສິ່ງເສດເຫຼືອຂອງສິ່ງເສດເຫຼືອຈາກສິ່ງເສດເຫຼືອທີ່ຫຍ້າແລ້ວກັບສານຕ່າງ ທີ່ເປັນຕ່າງທີ່ມີ pH ສູງກວ່າ 11 ເພື່ອຜະລິດເປັນສວນປະສົມທຳອິດ; (v) ການປະສົມອາຫານສິ່ງເສດເຫຼືອ ສິ່ງເສດເຫຼືອທີ່ເປັນຕ່າງທີ່ເຮັດດ້ວຍສານຕັດຫຍິບດ້ວຍການແກ້ໄຂອາຊິດນ້ຳທີ່ມີ pH ຕໍ່າກວ່າ 5 ເພື່ອຜະລິດເປັນ ປະສົມທິສອງ; ແລະ (vi) ການກັ່ນຕອງປະສົມທິສອງເພື່ອໃຫ້ໄດ້ເຊລູໂລສ.
- (71) ASIA PACIFIC RESOURCES INTERNATIONAL HOLDINGS LTD
Dallas Building, 7 Victoria Street, Hamilton HM11 (BM), Bermuda.
- (72) GINTING, Eduward; ANTES, Rudine; PAIYDITA, Surya Darma and YING, H'ng Yin.
- (74) Lao Trademark Agency.
- (55)

Figure 1:



- (21) No. PT 949
- (22) 23/04/2024
- (30) 202111218202.X 20/10/2021 CN
- (43)
- (51) Int.Cl.2018.01E 01C 11/00(2006.01), E 01C 9/00(2006.01), H 02S 20/26(2014.01), H 02S 20/10(2014.01), E 03B 3/02(2006.01), E 03F 5/10(2006.01), F 24S 25/00(20180101)
- (54) ລະບົບອັດຕະໂນມັດເກັບຮັກສານໍ້າຜືນດິນບ່າທາງນໍ້າ-ຊົມຜ່ານໄດ້ສັງເຄາະໄຟຟ້າ
- (57) ລະບົບອັດຕະໂນມັດເກັບຮັກສານໍ້າຜືນດິນບ່າທາງນໍ້າ-ຊົມຜ່ານໄດ້ສັງເຄາະໄຟຟ້າໜຶ່ງລວມທັງຮູບແບບສັງເຄາະໄຟຟ້າໜຶ່ງ (10), ຫົວໜ່ວຍນໍ້າ-ຊົມຜ່ານໄດ້ໜຶ່ງ (20), ແລະໂຄງສ້າງນໍ້າ-ຖືກຕື່ມໜຶ່ງ (30). ຮູບແບບສັງເຄາະໄຟຟ້າ (10) ແມ່ນຖືກຈັດວາງເທິງໜ້າພຽງຜືນດິນໜຶ່ງ ແລະ ລວມທັງຜືນໜຶ່ງ (11). ແຜງຕາໜ່າງແສງຕາເວັນໜຶ່ງ (12) ແມ່ນຖືກຕັ້ງຂຶ້ນເທິງຂ້າງເທິງໜຶ່ງຂອງຜືນ (11). ເຮັດໃຫ້ຄືງທີ່ສະມາຊິກ (112) ແມ່ນຖືກສະໜອງເທິງຜືນໜຶ່ງຂອງຜືນ (11) ແລະ ຝັນຕາແໜງເທິງຫົວໜ່ວຍນໍ້າ-ຊົມຜ່ານໄດ້ (20). ຕົ້ນທີ່ຫວາງເປົ່າໜຶ່ງ (113) ແມ່ນຖືກສະໜອງຂ້າງໃນຜືນ (11). ບໍ່ສີ່ສານ (13) ແມ່ນຖືກເຊື່ມຕໍ່ຫາ ແລະ ຖືກຂະຫຍາຍອອກຈາກຕົ້ນທີ່ວ່າງເປົ່າ (113) ເພື່ອສື່ສານດ້ວຍຜືນດັດປັບ (11). ຫົວໜ່ວຍນໍ້າ-ຊົມຜ່ານໄດ້ (20) ແມ່ນບ່າທາງນໍ້າ-ຊົມຜ່ານໄດ້ໜຶ່ງລວມທັງໂຄງສ້າງກອບໜຶ່ງຖືກສ້າງຂອງຫຼາກຫຼາຍບ່ານໍ້າຊົມຜ່ານທາງຕັ້ງ ແລະ ຖືກຖອກ ດ້ວຍຄອນກິດແຫຼວຊັ້ນ. ໂຄງສ້າງນໍ້າ-ຖືກຕື່ມ (30) ແມ່ນຊ່ອງ ຫວ່າງການເກັບຮັກສາ ນໍ້າຜືນດິນໜຶ່ງ ຖືກສ້າງຂຶ້ນຈາກຫ້ອງຫົວໜ່ວຍຫຼາກ-ຫຼາຍ-ຮູໂກນ (30a). ແຜ່ນນໍ້າພານໍ້າໜຶ່ງ (B) ແມ່ນຖືກສະໜອງທີ່ເບື້ອງເທິງຂອງໂຄງສ້າງນໍ້າ-ຖືກຕື່ມ (30) ຖືກຝັງໃນແຜ່ນຜືນດິນໜຶ່ງຕໍ່ກວ່າຫົວໜ່ວຍນໍ້າ-ຊົມຜ່ານໄດ້ (20).
- (71) CHEN, Jui-Wen
No. 23, Ln.123, Junying St., Shulin Dist., New Taipei City, Taiwan 238, Taiwan.
- (72) CIHEN, Jui-Wen.
- (74) CONCETTI- Representative Bureau in LAOS..
- (55)

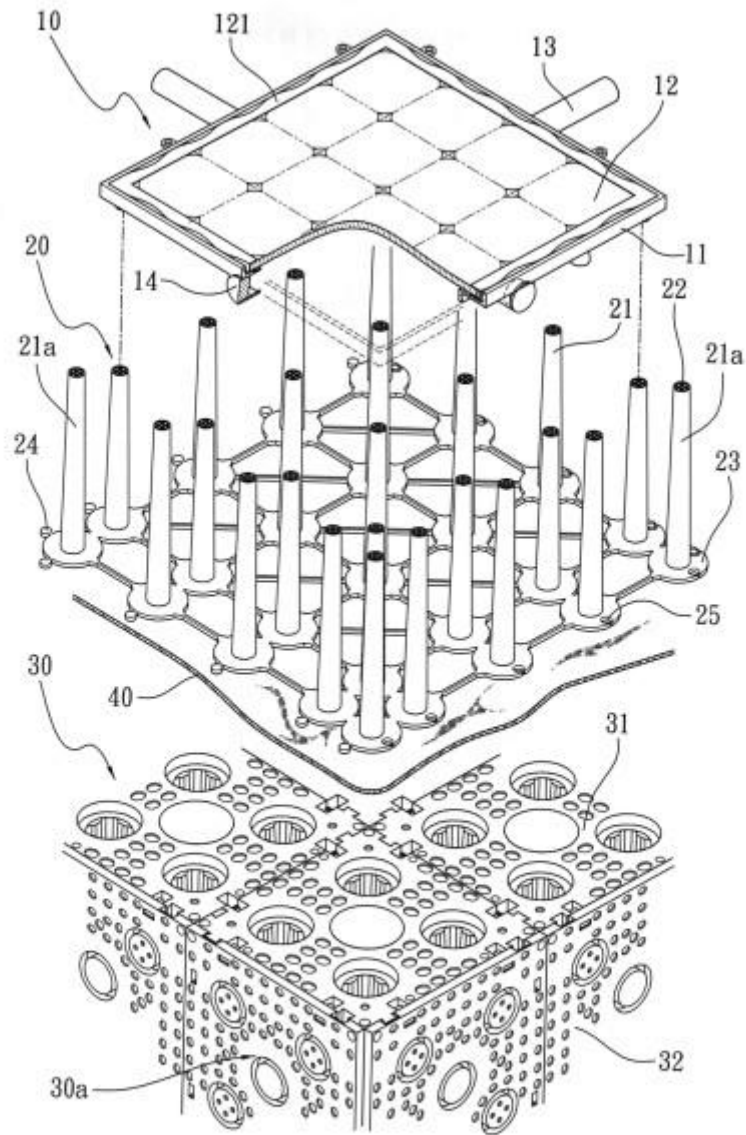
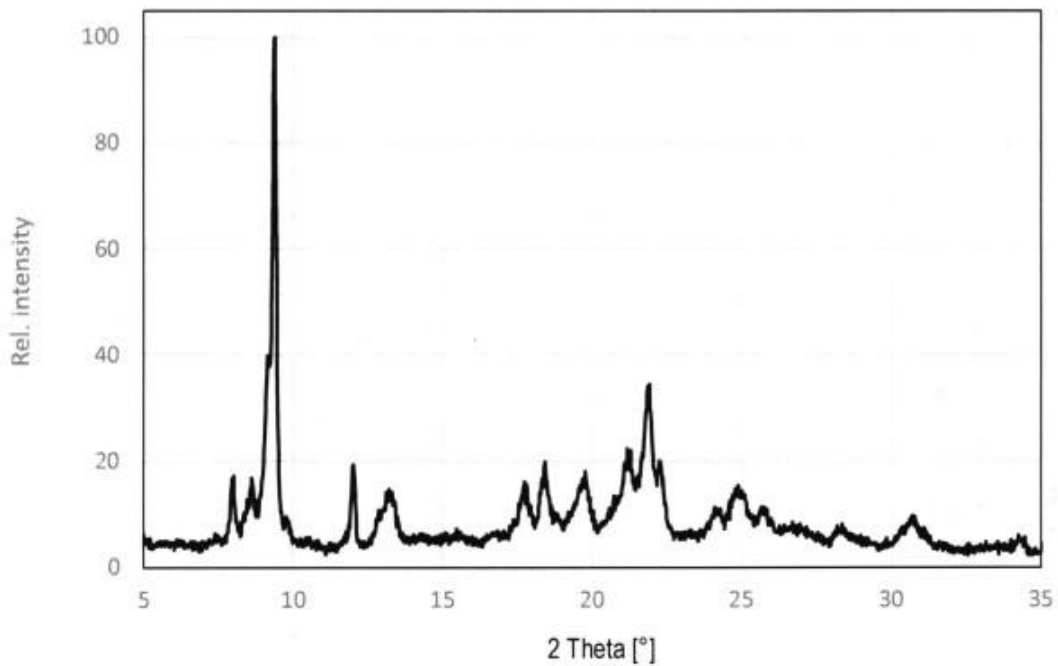

FIG. 1

- (21) No. PT 955
- (22) 17/06/2024
- (30) 21215583.2 17/12/2021 EU
- (43)
- (51) Int.Cl.2018.01C 07D 401/14(2006.01), A 61K 31/506(2006.01), A 61P 9/00(2006.01)
- (54) ຂະບວນການເພື່ອກະກຽມເກືອໄດໂຊດຽມຂອງຄລາໂຊເຊັນແທນ
- (57) ການປະດິດປັດຈຸບັນກ່ຽວຂ້ອງກັບ ເກືອໄດໂຊດຽມຂອງ ຄລາໂຊເຊັນແທນ ແລະ ຂະບວນການເພື່ອກະກຽມສິ່ງນັ້ນ.
(71) Nxera Pharma Co., Ltd.
9-7-2 Akasaka, Minato-ku, Tokyo 107-0052, Japan.
- (72) AIGLSTORFER-HAAG, Iris.
- (74) Tilleke & Gibbins Lao Co., Ltd.
- (55)

Figure 1



Official Gazette of Industrial Property Vol. 355, 08/05/2026

- (21) No. PT 957
(22) 21/06/2024
(30) 202111639861.0 29/12/2021 CN
(43)
(51) Int.Cl.2018.01F 04D 25/08(2006.01), F 04D 29/26(2006.01), F 04D 29/28(2006.01), F 04D 29/66(2006.01), F 04D 29/40(2006.01), F 04D 29/44(2006.01), F 04D 29/30(2006.01)
(54) ອຸປະກອນໃບມິດປະສົມປະສານ ແລະ ອຸປະກອນຊ່ອງອອກອາກາດປະສົມປະສານ
(57) A combined blade device and a combined air outlet device are disclosed. The combined blade device (100) includes a hub (110), diagonal flow blades (120), and centrifugal blades (130), where a first air inlet (140) is formed outside an edge of a first end of the hub (110), and a first air outlet (150) is formed outside an edge of a second end of the hub (110), the hub (110) is internally provided with a centrifugal cavity (111), the first end of the hub (110) is provided with a second air inlet (112), the first air inlet (140) surrounds the second air inlet (112), the second end of the hub (110) is provided with a second air outlet (113), both the second air inlet (112) and the second air outlet (113) are communicated with the centrifugal cavity (111), and the hub (110) expands gradually in a direction from the second air inlet (112) to the second air outlet (113); the diagonal flow blades (120) are connected to one side of the hub (110) that is away from the centrifugal cavity (111); and the centrifugal blades (130) are connected to the hub (110) and located in the centrifugal cavity (111), and rotating axes of diagonal flow blades (120) and the centrifugal blades (130) coincide with each other. The combined blade device can make full use of the air inlet area at the air inlet side of the hub to increase the air inlet volume and improve the air pressure and air volume of the air outlet device..
(71) XUXIN TECHNOLOGY (SHENZHEN) GROUP CO., LTD
Room 2404, Yaohua Creation Building, No.6023 Shennan Avenue, Tian An Community, Sha Tou Street, Futian District, Shenzhen, Guangdong 518042, China.
(72) ZHANG, Ping; HU, Shanxian; SUN, Xinglin; ZHOU, Huizhu; SUN, Yelin and LUO, Lanying.
(74) CONCETTI-LAO CO., LTD.
(55)

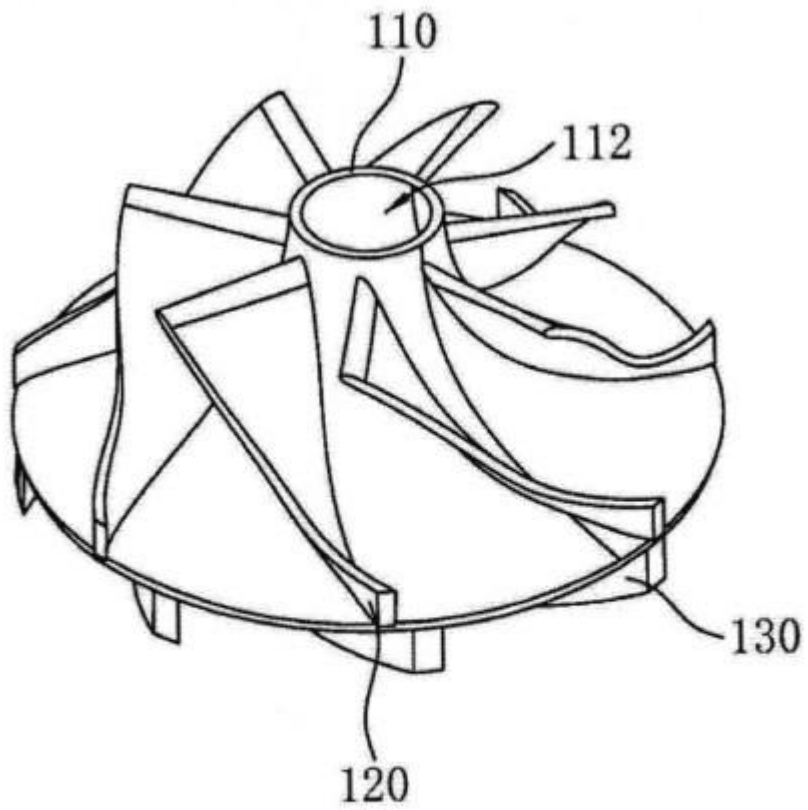

FIG. 1

ພາກທີ I

(Part I)

ສິດທິບັດ ແລະ ອະນຸສິດທິບັດ (Patent and Petty Patent)

2. ຜົນການອອກສິດທິບັດ ແລະ ອະນຸສິດທິບັດ (Grant of Patents and Petty Patents)

ຄຳອະທິບາຍກ່ຽວກັບລະຫັດຫຍໍ້

(Introduction of Codes)

- (11) ເລກທິ (Grant Number)
- (21) ເລກທິ ຄຳຮ້ອງ (Filing Number)
- (22) ວັນທິຍືນຄຳຮ້ອງ (Filing Date)
- (30) ວັນທິ ບຸລິມະສິດ (Priority Date)
- (43) ວັນທິເຜີຍແຜ່ (Publication Date)
- (51) ໝວດ (International Patent Classification)
- (54) ຫົວຂໍ້ການປະດິດ (Title)
- (57) ບົດຄັດຫຍໍ້ (Abstract)
- (71) ຊື່ ແລະ ທີ່ຢູ່ ເຈົ້າຂອງສິດທິບັດ ແລະ ອະນຸສິດທິບັດ (Owner Name and Address)
- (72) ຊື່ຜູ້ປະດິດ (Inventor Name)
- (74) ຊື່ຕົວແທນ (Representative Name)
- (55) ຮູບພາບ (Pictures)

ພາກທີ I

(Part I)

**ສິດທິບັດ ແລະ ອະນຸສິດທິບັດ
(Patent and Petty Patent)**

**3. ການປ່ຽນແປງ
(Changes)**

ພາກທີ I

(Part I)

**ສິດທິບັດ ແລະ ອະນຸສິດທິບັດ
(Patent and Petty Patent)**

4. ການດັດແກ້

(Amendments)

ພາກທີ II
(Part II)
ແບບອຸດສາຫະກຳ
(Industrial Design)

1. ຄຳຮ້ອງ
(Applications)

ຄຳອະທິບາຍກ່ຽວກັບລະຫັດຫຍໍ້
(Introduction of Codes)

- (21) ເລກທີ ຄຳຮ້ອງ (Filing Number)
- (22) ວັນທີ ຄຳຮ້ອງ (Filing Date)
- (30) ວັນທີ ບຸລິມາສິດ (Priority Date)
- (51) ໝວດ (Locarno Classification)
- (54) ຊື່ຂອງແບບອຸດສາຫະກຳ (Title)
- (71) ຊື່ ແລະ ທີ່ຢູ່ ຂອງເຈົ້າຂອງ (Owner Name and Address)
- (72) ຊື່ຜູ້ອອກແບບ (Designer Name)
- (74) ຊື່ຕົວແທນ (Representative Name)
- (55) ຮູບພາບ (Pictures)

ພາກທີ II
(Part II)
ແບບອຸດສາຫະກຳ
(Industrial Design)

2. ຜົນການຈົດທະບຽນ
(Registration)

ຄຳອະທິບາຍກ່ຽວກັບລະຫັດຫຍໍ້
(Introduction of Codes)

- (11) ເລກທີ ຈົດທະບຽນ (Registration Number)
- (15) ວັນທີ ຈົດທະບຽນ (Registration Date)
- (21) ເລກທີ ຍືນຄຳຮ້ອງ (Filing Number)
- (22) ວັນທີ ຍືນຄຳຮ້ອງ (Filing Date)
- (30) ວັນທີ ບຸລິມາສິດ (Priority Date)
- (17) ວັນທີ ໝົດອາຍຸ (Expiration Date)
- (51) ໝວດ (Locarno Classification)
- (54) ຊື່ຂອງແບບອຸດສາຫະກຳ (Title)
- (71) ຊື່ ແລະ ທີ່ຢູ່ ຂອງເຈົ້າຂອງ (Owner Name and Address)
- (72) ຊື່ຜູ້ອອກແບບ (Designer Name)
- (74) ຊື່ຕົວແທນ (Representative Name)
- (55) ຮູບພາບ (Pictures)

Official Gazette of Industrial Property Vol. 355, 08/05/2026

- | | | | |
|------|---|------|------------|
| (11) | No. 707 | (21) | ID 707 |
| (15) | 05/05/2026 | (22) | 19/11/2025 |
| (28) | | (17) | 19/11/2030 |
| (30) | 2025306049561 15/10/2025 CN | (51) | 23-04 |
| (54) | "BLADELESS FAN" | | |
| (71) | Ningbo Singfun Electric Appliance Co.,Ltd.
Address(including post code): Fuhai Develop Area, Cixi, Zhejiang 315332, China. | | |
| (72) | Ya XU. | | |
| (74) | KENFOX (LAO) IP SERVICE CO., LTD.. | | |
| (55) | | | |











Official Gazette of Industrial Property Vol. 355, 08/05/2026

- | | | | |
|------|---|------|------------|
| (11) | No. 708 | (21) | ID 708 |
| (15) | 05/05/2026 | (22) | 20/11/2025 |
| (28) | | (17) | 20/11/2030 |
| (30) | 202530625314X 24/10/2025 CN | (51) | 23-03 |
| (54) | "FAN HEAD" | | |
| (71) | Ningbo Singfun Electric Appliance Co.,Ltd.
Address(including post code): Fuhai Develop Area, Cixi, Zhejiang 315332, China. | | |
| (72) | Ya XU. | | |
| (74) | KENFOX (LAO) IP SERVICE CO., LTD.. | | |
| (55) | | | |



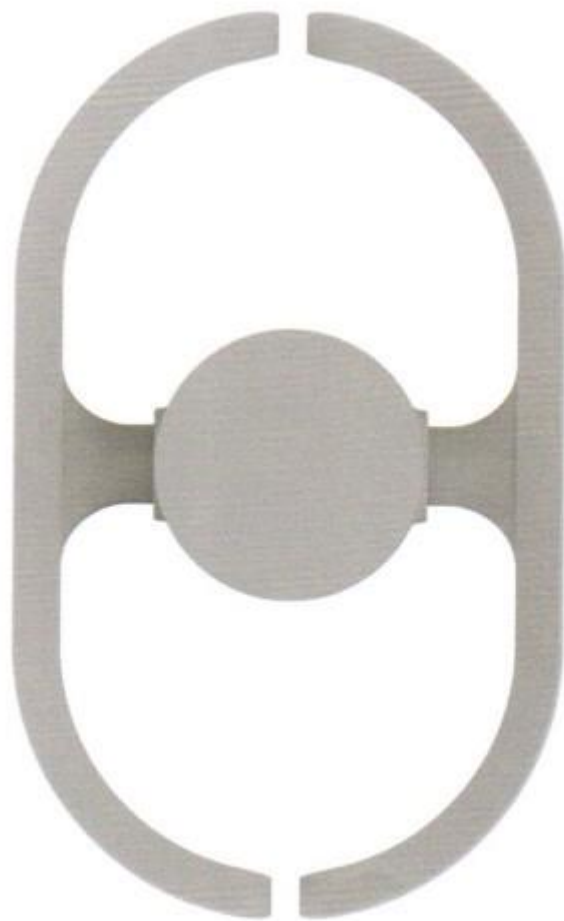

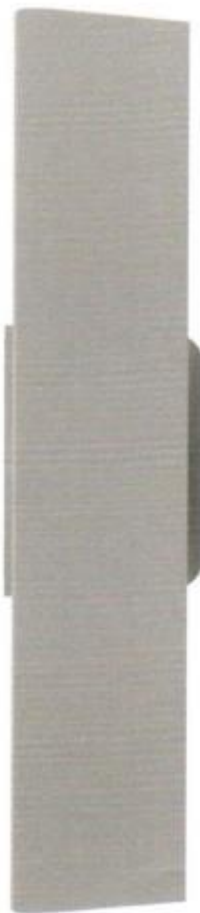





Official Gazette of Industrial Property Vol. 355, 08/05/2026

- | | | | |
|------|---|------|------------|
| (11) | No. 709 | (21) | ID 709 |
| (15) | 05/05/2026 | (22) | 20/11/2025 |
| (28) | | (17) | 20/11/2030 |
| (30) | 202530625314X 24/10/2025 CN | (51) | 23-03 |
| (54) | "FAN HEAD" | | |
| (71) | Ningbo Singfun Electric Appliance Co.,Ltd.
Address(including post code): Fuhai Develop Area, Cixi, Zhejiang 315332, China. | | |
| (72) | Ya XU. | | |
| (74) | KENFOX (LAO) IP SERVICE CO., LTD.. | | |
| (55) | | | |



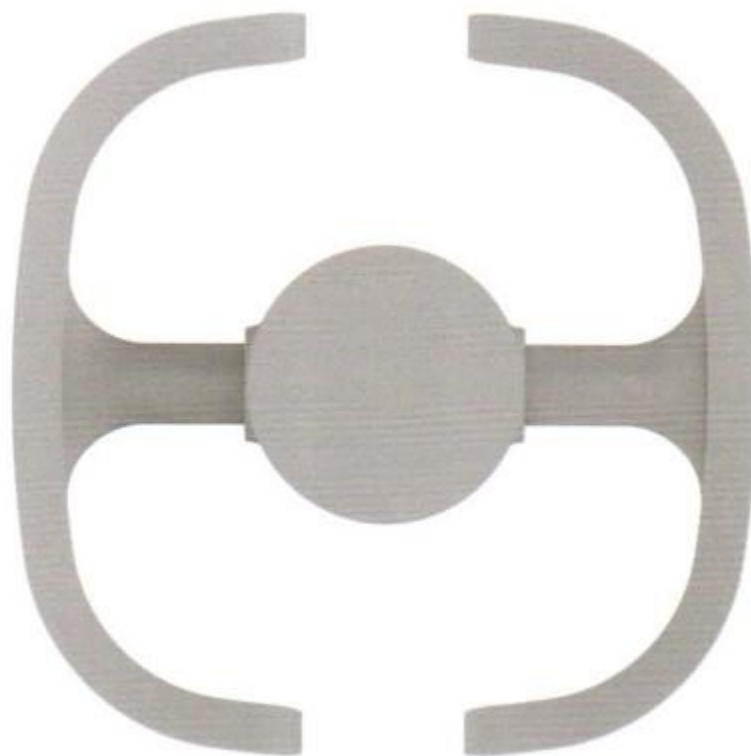







Official Gazette of Industrial Property Vol. 355, 08/05/2026

- | | | | |
|------|--|------|------------|
| (11) | No. 710 | (21) | ID 710 |
| (15) | 05/05/2026 | (22) | 20/11/2025 |
| (28) | | (17) | 20/11/2030 |
| (30) | 20253062531X 24/10/2025 CN | (51) | 23-03 |
| (54) | "FAN HEAD" | | |
| (71) | Ningbo Singfun Electric Appliance Co.,Ltd.
Address (including post code): Fuhai Develop Area, Cixi, Zhejiang 315332, China. | | |
| (72) | Ya XU. | | |
| (74) | KENFOX (LAO) IP SERVICE CO., LTD.. | | |
| (55) | | | |

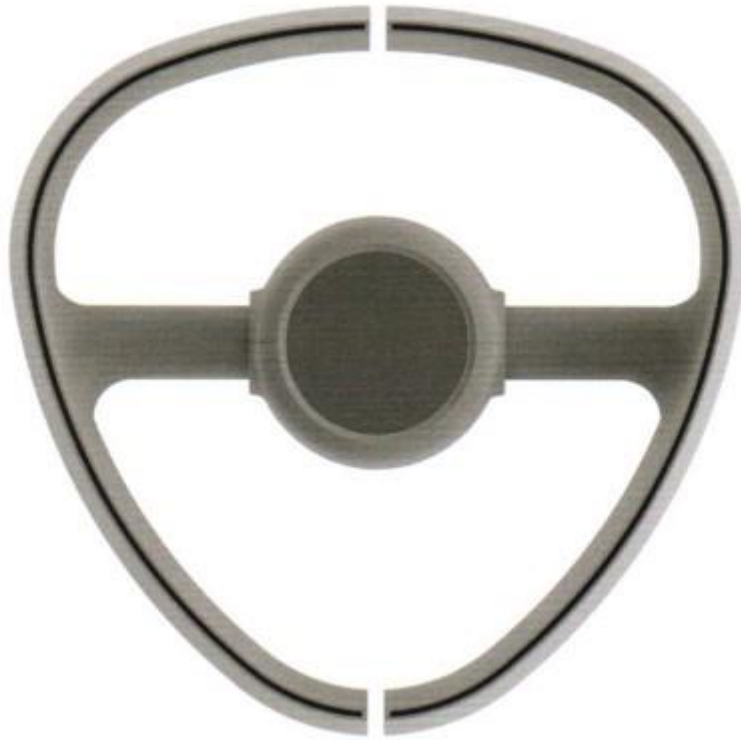

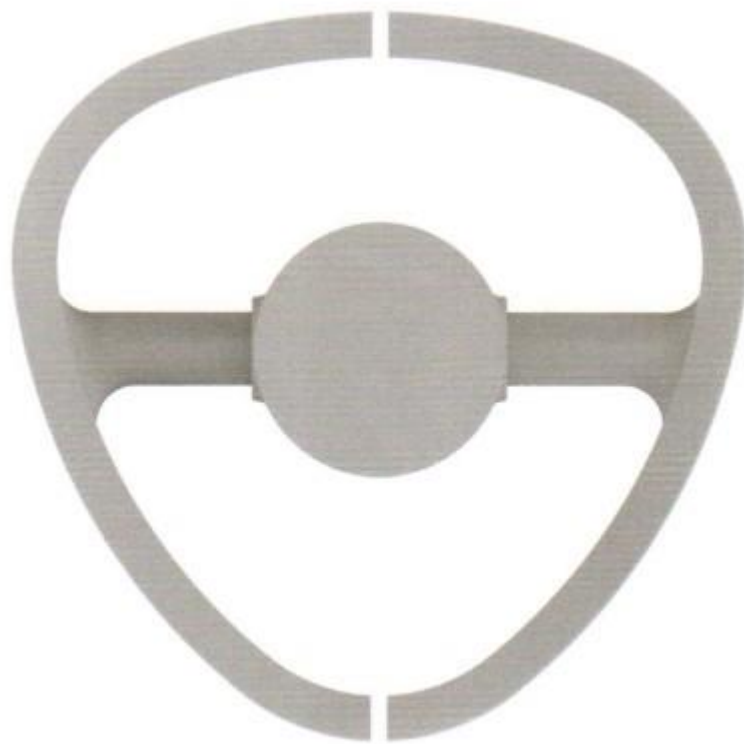







ພາກທີ II

(Part II)

ແບບອຸດສາຫະກຳ

(Industrial Design)

3. ການປ່ຽນແປງ

(Changes)

ພາກທີ II

(Part II)

ແບບອຸດສາຫະກຳ

(Industrial Design)

4. ການດັດແກ້

(Amendments)

ພາກທີ III
(Part III)
ເຄື່ອງໝາຍການຄ້າ
Trademarks

1. ຄໍາຮ້ອງ
(Applications)

ຄໍາອະທິບາຍກ່ຽວກັບລະຫັດຫຍໍ້
(Introduction of Codes)

- (540) ເຄື່ອງໝາຍການຄ້າ (Trademark)
- (511) ໝວດ (Nice Classification)
- (210) ເລກທີ ຄໍາຮ້ອງ (Number of the application)
- (220) ວັນທີ ຄໍາຮ້ອງ (Date of filing of the application)
- (732) ຊື່ ແລະ ທີ່ຢູ່ ຂອງຜູ້ຍື່ນຄໍາຮ້ອງ (Name and Address of applicant)

(540) Trademark Application

ROCKSWEET

(511) 03

(210) No. 53925

(220) 01/02/2026

(732) Guangzhou Zhiyue Brand Management Co.,
Ltd.

Room 506, Building C2, No. 27-2,
Yuanxiatian 4th Road, Yongtai, Yongping
Street, Baiyun District, Guangzhou, China.

(540) Trademark Application

YOCHI

(511) 43

(210) No. 53926

(220) 02/02/2026

(732) EMBRACE THE CHI PTY LTD

PO BOX 399 Avalon Beach NSW 2107,
Australia.

(540) Trademark Application

Maiden Yang

(511) 03

(210) No. 53927

(220) 02/02/2026

(732) Shanghai Youfei Cosmetics Co., Ltd.

Room J2819, Area B, 12th Floor, Building 1,
No. 399 Zhongren Road, Jiading District,
Shanghai, China.

(540) Trademark Application

AIDOFĒC

(511) 03

(210) No. 53928

(220) 02/02/2026

(732) Shanghai Youfei Cosmetics Co., Ltd.

Room J2819, Area B, 12th Floor, Building 1,
No. 399 Zhongren Road, Jiading District,
Shanghai, China.

(540) Trademark Application

NimbleOS

(511) 09 and 42

(210) No. 53929

(220) 03/02/2026

(732) Ninebot (Beijing) Technology Co., Ltd.

Room 103/105, A-1 Bldg. Zhongguancun

Dongsheng Technology Park (Northern

Territory), No. 66, Xixiaokou Rd, Haidian

Dist., Beijing, China.

(540) Trademark Application



(511) 09 and 37

(210) No. 53930

(220) 03/02/2026

(732) ບໍລິສັດ ຈິງເດິາ ກຣຸບ (ລາວ) ອິນເວດເມັ້ນ

ຈຳກັດຜູ້ດຽວ

ບ້ານ ນາຄຳ, ເມືອງ ສີໂຄດຕະບອງ,

ນະຄອນຫຼວງວຽງຈັນ, ສປປ ລາວ

(540) Trademark Application



(511) 20, 37 and 43

(210) No. 53931

(220) 03/02/2026

(732) ບໍລິສັດ ເຮໂລ (ລາວ) ອະສັງຫາລິມະຊັບ ຈຳກັດ
ບ້ານ ທາດຫຼວງເໜືອ, ເມືອງ ໄຊເສດຖາ,
ນະຄອນຫຼວງວຽງຈັນ, ສປປ ລາວ

(540) Trademark Application



(511) 43

(210) No. 53932

(220) 03/02/2026

(732) ບໍລິສັດ ອໍເຣນ ຄຣິດຕັນ ໂຮເທວ ຈຸຊິຊຸຍຈິງ ໂຮເທວ
ບໍລິຫານ ຈຳກັດ.
ບ້ານ ໜອງສະໂນຄຳ, ເມືອງ ສີໂຄດຕະບອງ,
ນະຄອນຫຼວງວຽງຈັນ, ສປປ ລາວ

(540) Trademark Application



(511) 43

(210) No. 53933

(220) 03/02/2026

(732) ບໍລິສັດ ອໍເຣນ ຄຣິດຕັນ ໂຮເທວ ຈຸຊີຊຸຍຈິງ ໂຮເທວ
ບໍລິຫານ ຈໍາກັດ.
ບ້ານ ໜອງສະໂນຄໍາ, ເມືອງ ສີໂຄດຕະບອງ,
ນະຄອນຫຼວງວຽງຈັນ, ສປປ ລາວ

(540) Trademark Application

GET SET STING

(511) 32

(210) No. 53934

(220) 03/02/2026

(732) PepsiCo, Inc.
700 Anderson Hill Road, Purchase,
New York 10577, United States of America.

(540) Trademark Application

Usefully

(511) 05

(210) No. 53935

(220) 03/02/2026

(732) Beijing Xiuzhu Technology Co., Ltd.

Room 505, Unit 3, 5th Floor, Building 4, Yard
6, Auto Museum East Road, Fengtai District,
Beijing 10000, China.

(540) Trademark Application



(511) 35

(210) No. 53936

(220) 04/02/2026

(732) ນາງ ຈິນສະໜອນ ເລືອງບຸດ

ບ້ານ ວິງວິໄລ, ເມືອງເຊໂປນ, ແຂວງສະຫວັນນະເຂດ,
ສປປ ລາວ

(540) Trademark Application



(511) 03 and 05

(210) No. 53937

(220) 04/02/2026

(732) ນາງ ຈິນສະໝອນ ເລືອງບຸດ

ບ້ານ ວົງວິໄລ, ເມືອງເຊໂປນ, ແຂວງ ສະຫວັນນະເຂດ,
ສປປ ລາວ

(540) Trademark Application



(511) 29

(210) No. 53938

(220) 04/02/2026

(732) ບໍລິສັດ ວຽງຈັນ ເຈຍເໝີຍ ລົງທຶນ ຈຳກັດ

ບ້ານດົງນາໂຊກ, ເມືອງສີໂຄດຕະບອງ,
ນະຄອນຫຼວງວຽງຈັນ, ສປປ ລາວ

(540) Trademark Application

The logo consists of the text "NR-IGrid" in a bold, sans-serif font. The "I" is stylized as a lightning bolt or a curved arrow pointing to the right, and the "G" is also stylized with a curved arrow pointing to the right.

(511) 09

(210) No. 53939

(220) 04/02/2026

(732) NR ELECTRIC CO., LTD.

No.69 Suyuan Avenue, Jiangning, Nanjing,
Jiangsu, 211102, China.

(540) Trademark Application



(511) 29

(210) No. 53940

(220) 04/02/2026

(732) CHUA HAH SENG FOOD PRODUCT CO.,
LTD.

259 ISSARANUPARP LANE, YAOWARAT
ROAD, CHAKKRAWAT,
SAMPANTHAWONG, BANGKOK 10100
THAILAND.

(540) Trademark Application



(511) 30

(210) No. 53941

(220) 04/02/2026

(732) CHUA HAH SENG FOOD PRODUCT CO.,
LTD.

259 ISSARANUPARP LANE, YAOWARAT
ROAD, CHAKKRAWAT,
SAMPHANTHAWONG, BANGKOK 10100
THAILAND.

(540) Trademark Application



(511) 29

(210) No. 53942

(220) 04/02/2026

(732) CHUA HAH SENG FOOD PRODUCT CO.,
LTD.

259 ISSARANUPARP LANE, YAOWARAT
ROAD, CHAKKRAWAT,
SAMPHANTHAWONG, BANGKOK 10100
THAILAND.

(540) Trademark Application



(511) 30

(210) No. 53943

(220) 04/02/2026

(732) CHUA HAH SENG FOOD PRODUCT CO.,
LTD.

259 ISSARANUPARP LANE, YAOWARAT
ROAD, CHAKKRAWAT,
SAMPHANTHAWONG, BANGKOK 10100
THAILAND.

(540) Trademark Application

yoosee

(511) 09 and 35

(210) No. 53944

(220) 05/02/2026

(732) Shenzhen Gwell Times Technology Co., Ltd.
room 01-04, 28th floor, Block C of Minzhi
stock business center, Minzhi street, Longhua
district, Shenzhen, Guangdong, China.

(540) Trademark Application



(511) 03

(210) No. 53945

(220) 05/02/2026

(732) SEYNI DINGO HABIBOULAYE

Quartier Koubia No.631 19402 Niamey,
Niger.

(540) Trademark Application



(511) 09 and 35

(210) No. 53946

(220) 05/02/2026

(732) Shenzhen Gwell Times Technology Co., Ltd.

room 01-04, 28th floor, Block C of Minzhi
stock business center, Minzhi street, Longhua
district, Shenzhen, Guangdong, China.

(540) Trademark Application

The logo for Evercon features the word "Evercon" in a bold, sans-serif font. The letter "o" is replaced by a stylized sun or lens icon with radiating lines.

(511) 10

(210) No. 53947

(220) 05/02/2026

(732) Fujian Evercon Optical Co., Ltd.

Fence of Fuzhou Comprehensive Bonded
Zone (Pilot Free Trade Zone). No. 177-9
Changyang Road, Tingjiang Town, Mawei
District, Fuzhou City, Fujian Province, China.

(540) Trademark Application

The logo for MIXUE features a stylized character on the left, resembling a smiling figure with a crown and a small object in its hand. To the right of the character, the word "MIXUE" is written in a bold, sans-serif font.

(511) 07 and 24

(210) No. 53948

(220) 05/02/2026

(732) MIXUEBINGCHENG CO., LTD.

Room 16004, Block A, Hanhaibeijin Business
Center, North 3rd Ring Wenhua Road, Jinshui
District, Zhengzhou City, Henan Province,
China.

(540) Trademark Application



LUCKY CUP

(511) 03, 06, 07, 09, 11, 14, 16, 18, 20, 21, 24, 25,
26 and 28

(210) No. 53949

(220) 05/02/2026

(732) MIXUEBINGCHENG CO., LTD.

Room 16004, Block A, Hanhaibeijin Business
Center, North 3rd Ring Wenhua Road, Jinshui
District, Zhengzhou City, Henan Province,
China.

(540) Trademark Application



(511) 05 and 29

(210) No. 53950

(220) 05/02/2026

(732) ABLE DAIRIES SDN. BHD.

LOT 2259 JALAN HELANG OFF JALAN
KEBUN BARU, 9TH MILE JALAN
KLANG BANTING, TELOK PANGLIMA
GARANG, 42500 SELANGOR,
MALAYSIA.

(540) Trademark Application



(511) 09, 35 and 42

(210) No. 53951

(220) 06/02/2026

(732) Zhejiang Sav Digital Power Technologies
Co., Ltd.

No. 15, Airport South Road, Xiachen Street,
Jiaojiang District, Taizhou, Zhejiang
Province, China.

(540) Trademark Application



(511) 30

(210) No. 53952

(220) 06/02/2026

(732) ບໍລິສັດ ອາກ້າພັສ ຂົນສົ່ງພາຍໃນ ແລະ ຕ່າງປະເທດ
ຈຳກັດຜູ້ດຽວ.

ບ້ານ ຄຳສະຫວາດ, ເມືອງ ໄຊເສດຖາ,
ນະຄອນຫຼວງວຽງຈັນ, ສປປ ລາວ

(540) Trademark Application



(511) 30

(210) No. 53953

(220) 06/02/2026

(732) ບໍລິສັດ ອາກ້າພັສ ຂົນສົ່ງພາຍໃນ ແລະ ຕ່າງປະເທດ

ຈຳກັດຜູ້ດຽວ

ບ້ານ ຄຳສະຫວາດ, ເມືອງ ໄຊເສດຖາ,

ນະຄອນຫຼວງວຽງຈັນ, ສປປ ລາວ

(540) Trademark Application



(511) 43

(210) No. 53954

(220) 06/02/2026

(732) ບໍລິສັດ ເປັນຊຸ ບໍລິການ (ລາວ) ຈຳກັດ

ໜ່ວຍ 04, ບ້ານ ຂົວຫຼວງ, ເມືອງ ຈັນທະບູລີ,

ນະຄອນຫຼວງວຽງຈັນ, ສປປ ລາວ

(540) Trademark Application



(511) 35 and 45

(210) No. 53955

(220) 06/02/2026

(732) ບໍລິສັດ ລໍເຟີສ ສໍານັກງານກົດໝາຍ ຈຳກັດ
ບ້ານ ທາດຫຼວງໃຕ້, ເມືອງ ໄຊເສດຖາ,
ນະຄອນຫຼວງວຽງຈັນ, ສປປ ລາວ

(540) Trademark Application



(511) 04, 06, 12 and 16

(210) No. 53956

(220) 06/02/2026

(732) ບໍລິສັດ ເຈອີ ການຄ້າ ຈຳກັດຜູ້ດຽວ
ບ້ານ ຫົວເມືອງໃຕ້, ເມືອງ ນະຄອນໄກສອນພົມວິຫານດ
ແຂວງ ສະຫ້ວນນະເຂດ, ສປປ ລາວ

(540) Trademark Application



(511) 04, 06, 12 and 16

(210) No. 53957

(220) 06/02/2026

(732) ບໍລິສັດ ເຈອີ ການຄ້າ ຈຳກັດຜູ້ດຽວ

ບ້ານ ຫົວເມືອງໃຕ້, ເມືອງ ນະຄອນໄກສອນພົມວິຫານ,

ແຂວງ ສະຫວັນນະເຂດ, ສປປ ລາວ

(540) Trademark Application



(511) 04, 06, 12 and 16

(210) No. 53958

(220) 06/02/2026

(732) ບໍລິສັດ ເຈອີ ການຄ້າ ຈຳກັດຜູ້ດຽວ

ບ້ານ ຫົວເມືອງໃຕ້, ເມືອງ ນະຄອນໄກສອນພົມວິຫານ,

ແຂວງ ສະຫວັນນະເຂດ, ສປປ ລາວ

(540) Trademark Application



(511) 35

(210) No. 53959

(220) 06/02/2026

(732) ບໍລິສັດ ແອວເຈການຄໍາລາວ-ສາກົນຂາອອກ-ຂາເຂົ້າ
ຈໍາກັດຜູ້ດຽວ.

ບ້ານ ຮ່ອງຄໍາ, ເມືອງ ຈັນທະບູລີ,
ນະຄອນຫຼວງວຽງຈັນ, ສປປ ລາວ

(540) Trademark Application

Ronshen

(511) 11

(210) No. 53962

(220) 06/02/2026

(732) Wu Li

No. 11, Group 13, Shazitian Village,
Xintianpu Town, Xinshao County,
Hunan Province, China.

(540) Trademark Application

ZEEHO

(511) 12

(210) No. 53963

(220) 06/02/2026

(732) Wu Li

No. 11, Group 13, Shazitian Village,
Xintianpu Town, Xinshao County,
Hunan Province, China.

(540) Trademark Application

DiDi

(511) 09

(210) No. 53964

(220) 06/02/2026

(732) Hongtong County Weizheng Enterprise
Management Co., Ltd.

Second Floor, Shop 07, Southeast Corner of
Hengmei Huating Community, Hongtong
North Road, Hongtong County, Linfen City,
Shanxi Province, China.

(540) Trademark Application

DiDi

(511) 12

(210) No. 53965

(220) 06/02/2026

(732) Hongtong County Weizheng Enterprise
Management Co., Ltd.

Second Floor, Shop 07, Southeast Corner of
Hengmei Huating Community, Hongtong
North Road, Hongtong County, Linfen City,
Shanxi Province, China.

(540) Trademark Application

DiDi

(511) 35

(210) No. 53966

(220) 06/02/2026

(732) Hongtong County Weizheng Enterprise
Management Co., Ltd.

Second Floor, Shop 07, Southeast Corner of
Hengmei Huating Community, Hongtong
North Road, Hongtong County, Linfen City,
Shanxi Province, China.

(540) Trademark Application

DiDi

(511) 36

(210) No. 53967

(220) 06/02/2026

(732) Hongtong County Weizheng Enterprise
Management Co., Ltd.

Second Floor, Shop 07, Southeast Corner of
Hengmei Huating Community, Hongtong
North Road, Hongtong County, Linfen City,
Shanxi Province, China.

(540) Trademark Application

DiDi

(511) 37

(210) No. 53968

(220) 06/02/2026

(732) Hongtong County Weizheng Enterprise
Management Co., Ltd.

Second Floor, Shop 07, Southeast Corner of
Hengmei Huating Community, Hongtong
North Road, Hongtong County, Linfen City,
Shanxi Province, China.

(540) Trademark Application

DiDi

(511) 39

(210) No. 53969

(220) 06/02/2026

(732) Hongtong County Weizheng Enterprise
Management Co., Ltd.

Second Floor, Shop 07, Southeast Corner of
Hengmei Huating Community, Hongtong
North Road, Hongtong County, Linfen City,
Shanxi Province, China.

(540) Trademark Application

DiDi

(511) 42

(210) No. 53970

(220) 06/02/2026

(732) Hongtong County Weizheng Enterprise
Management Co., Ltd.

Second Floor, Shop 07, Southeast Corner of
Hengmei Huating Community, Hongtong
North Road, Hongtong County, Linfen City,
Shanxi Province, China.

(540) Trademark Application

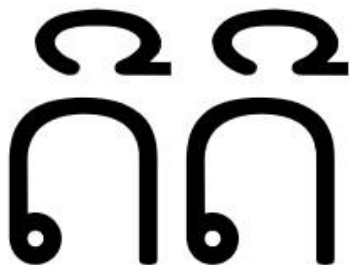

(511) 09

(210) No. 53971

(220) 06/02/2026

(732) Hongtong County Weizheng Enterprise
Management Co., Ltd.

Second Floor, Shop 07, Southeast Corner of
Hengmei Huating Community, Hongtong
North Road, Hongtong County, Linfen City,
Shanxi Province, China.

(540) Trademark Application

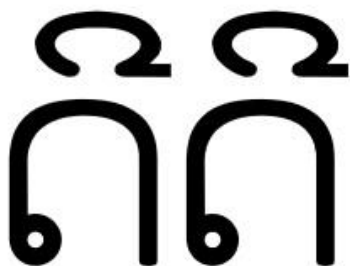

(511) 12

(210) No. 53972

(220) 06/02/2026

(732) Hongtong County Weizheng Enterprise
Management Co., Ltd.

Second Floor, Shop 07, Southeast Corner of
Hengmei Huating Community, Hongtong
North Road, Hongtong County, Linfen City,
Shanxi Province, China.

(540) Trademark Application

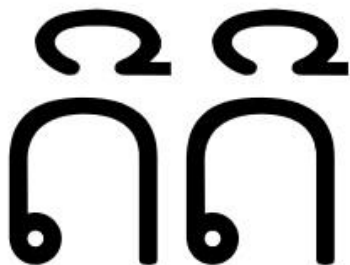

(511) 35

(210) No. 53973

(220) 06/02/2026

(732) Hongtong County Weizheng Enterprise
Management Co., Ltd.

Second Floor, Shop 07, Southeast Corner of
Hengmei Huating Community, Hongtong
North Road, Hongtong County, Linfen City,
Shanxi Province, China.

(540) Trademark Application

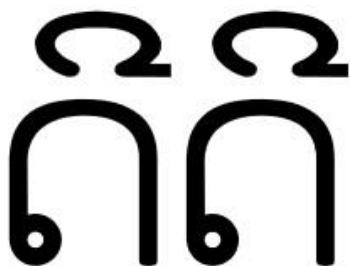

(511) 36

(210) No. 53974

(220) 06/02/2026

(732) Hongtong County Weizheng Enterprise
Management Co., Ltd.

Second Floor, Shop 07, Southeast Corner of
Hengmei Huating Community, Hongtong
North Road, Hongtong County, Linfen City,
Shanxi Province, China.

(540) Trademark Application

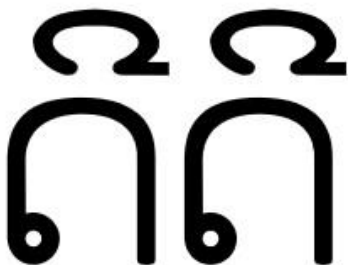

(511) 37

(210) No. 53975

(220) 06/02/2026

(732) Hongtong County Weizheng Enterprise
Management Co., Ltd.

Second Floor, Shop 07, Southeast Corner of
Hengmei Huating Community, Hongtong
North Road, Hongtong County, Linfen City,
Shanxi Province, China.

(540) Trademark Application

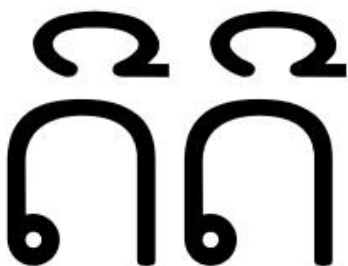

(511) 39

(210) No. 53976

(220) 06/02/2026

(732) Hongtong County Weizheng Enterprise
Management Co., Ltd.

Second Floor, Shop 07, Southeast Corner of
Hengmei Huating Community, Hongtong
North Road, Hongtong County, Linfen City,
Shanxi Province, China.

(540) Trademark Application

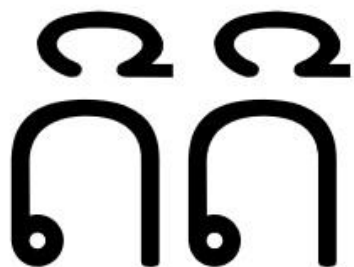

(511) 42

(210) No. 53977

(220) 06/02/2026

(732) Hongtong County Weizheng Enterprise
Management Co., Ltd.

Second Floor, Shop 07, Southeast Corner of
Hengmei Huating Community, Hongtong
North Road, Hongtong County, Linfen City,
Shanxi Province, China.

(540) Trademark Application



(511) 29

(210) No. 53978

(220) 06/02/2026

(732) PALDO CO., LTD.

7th Floor, 577, Gangnam-daero, Seocho-gu,
Seoul, Republic of Korea.

(540) Trademark Application



(511) 32

(210) No. 53979

(220) 06/02/2026

(732) PALDO CO., LTD.

7th Floor, 577, Gangnam-daero, Seocho-gu,
Seoul, Republic of Korea.

(540) Trademark Application



(511) 12

(210) No. 53980

(220) 06/02/2026

(732) CHENG SHIN RUBBER IND. CO., LTD.

No. 215, Meei-Kong Road, Huang-Ts'o
Village, Ta-Suen, Chang-Hwa Hsien,
Taiwan.

(540) Trademark Application



(511) 12

(210) No. 53981

(220) 06/02/2026

(732) CHENG SHIN RUBBER IND. CO., LTD.

No. 215, Meei-Kong Road, Huang-Ts'o
Village, Ta-Suen, Chang-Hwa Hsien,
Taiwan.

(540) Trademark Application



(511) 03, 08, 09, 10, 14, 18, 25 and 28

(210) No. 53982

(220) 06/02/2026

(732) ITALY ZERO (GROUP) HOLDING
LIMITED

RM 05 25/F WEALTH COMMERCIAL
CENTRE 42-56 KWONG WA STREET
MONGKOK KL 999077, HONG KONG.

(540) Trademark Application

아리

(511) 30

(210) No. 53983

(220) 07/02/2026

(732) PALDO CO., LTD.

7th Floor, 577, Gangnam-daero, Seocho-gu,
Seoul, Republic of Korea.

(540) Trademark Application

CST

(511) 12

(210) No. 53984

(220) 07/02/2026

(732) CHENG SHIN RUBBER IND. CO., LTD.

No. 215, Meei-Kong Road, Huang-Ts'o
Village, Ta-Suen, Chang-Hwa Hsien,
Taiwan.

(540) Trademark Application

VELOCE

(511) 12

(210) No. 53985

(220) 09/02/2026

(732) ບໍລິສັດ ເຄດິໄພີ ການຄ້າຂາອອກ-ຂາເຂົ້າ ຈຳກັດຜູ້ດຽວ.
ບ້ານ ຫ້ວຍນ້ຳເຢັນ, ເມືອງ ນາຊາຍທອງ,
ນະຄອນຫຼວງວຽງຈັນ, ສປປ ລາວ

(540) Trademark Application



(511) 12

(210) No. 53986

(220) 09/02/2026

(732) ບໍລິສັດ ເຄດິໄພີ ການຄ້າຂາອອກ-ຂາເຂົ້າ ຈຳກັດຜູ້ດຽວ.
ບ້ານ ຫ້ວຍນ້ຳເຢັນ, ເມືອງ ນາຊາຍທອງ,
ນະຄອນຫຼວງວຽງຈັນ, ສປປ ລາວ

(540) Trademark Application



(511) 29

(210) No. 53987

(220) 09/02/2026

(732) LAITA

4 Rue Henri Becquerel, F-29806 Brest Cedex
9, France.

(540) Trademark Application



(511) 29

(210) No. 53988

(220) 09/02/2026

(732) LAITA

4 Rue Henri Becquerel, F-29806 Brest Cedex
9, France.

(540) Trademark Application



(511) 05, 25, 32, 33, 34 and 35

(210) No. 53989

(220) 09/02/2026

(732) Ignite International Ltd.

3308 Towerwood Drive, Farmers Branch, TX
75234-2317, United States of America.

(540) Trademark Application



(511) 07 and 12

(210) No. 53990

(220) 09/02/2026

(732) TPR Kabushiki Kaisha (TPR CO., LTD.)

6-2, Marunouchi 1-chome Chiyoda-ku,
Tokyo 100-0005, Japan.

(540) Trademark Application

TPR

(511) 07 and 12

(210) No. 53991

(220) 09/02/2026

(732) TPR Kabushiki Kaisha (TPR CO., LTD.)

6-2, Marunouchi 1-chome Chiyoda-ku,
Tokyo 100-0005, Japan.

(540) Trademark Application

GOYARD

(511) 09

(210) No. 53992

(220) 09/02/2026

(732) GOYARD ST-HONORE

16 Place Vendôme, 75001 Paris, France.

(540) Trademark Application

GOYARD

(511) 10

(210) No. 53993

(220) 09/02/2026

(732) GOYARD ST-HONORE

16 Place Vendôme, 75001 Paris, France.

(540) Trademark Application

GOYARD

(511) 16

(210) No. 53994

(220) 09/02/2026

(732) GOYARD ST-HONORE

16 Place Vendôme, 75001 Paris, France.

(540) Trademark Application

GOYARD

(511) 18

(210) No. 53995

(220) 09/02/2026

(732) GOYARD ST-HONORE

16 Place Vendôme, 75001 Paris, France.

(540) Trademark Application

GOYARD

(511) 25

(210) No. 53996

(220) 09/02/2026

(732) GOYARD ST-HONORE

16 Place Vendôme, 75001 Paris, France.

(540) Trademark Application



(511) 11

(210) No. 53999

(220) 10/02/2026

(732) ບໍລິສັດ ອາຄິວ ຫວຽດ-ລາວ ການຄ້າ ແລະ
ບໍລິການເຄື່ອງບໍາບັດນໍ້າສະອາດ ຈຳກັດຜູ້ດຽວ
ບ້ານ ໂພນຕ້ອງສະຫວາດ, ເມືອງ ຈັນທະບູລີ,
ນະຄອນຫຼວງວຽງຈັນ, ສປປ ລາວ

(540) Trademark Application



ທະນາຄານພັດທະນາຊຸມນະບົດ
Rural Development Bank

(511) 36

(210) No. 54000

(220) 11/02/2026

(732) ທະນາຄານ ພັດທະນາຊຸມນະບົດ.
ບ້ານ ໂພນພະເນົາ, ເມືອງ ໄຊເສດຖາ,
ນະຄອນຫຼວງວຽງຈັນ, ສປປ ລາວ

(540) Trademark Application



(511) 30

(210) No. 54001

(220) 11/02/2026

(732) ບໍລິສັດ ລາວ ຈີອີຊາກະສິກຳເທັກໂນໂລຢີ ຈຳກັດ
ບ້ານຈຳປາ, ເມືອງສີໂຄດຕະບອງ,
ນະຄອນຫຼວງວຽງຈັນ, ສປປ ລາວ

(540) Trademark Application



(511) 28

(210) No. 54002

(220) 10/02/2026

(732) Dongguan Captain Fishing Gear Co., Ltd
Room 1001, Building 4, No.4 Baoshi Road,
Jiaoyitang, Tangxia Town, Dongguan City,
Guangdong Province, China.

(540) Trademark Application

KAMAN

(511) 12

(210) No. 54003

(220) 10/02/2026

(732) Kaman Aerospace Corporation

1332 Blue Hills Avenue, Bloomfield, CT
06002, United States of America.

(540) Trademark Application

K-MAX

(511) 12

(210) No. 54004

(220) 10/02/2026

(732) Kaman Aerospace Corporation

1332 Blue Hills Avenue, Bloomfield, CT
06002, United States of America.

(540) Trademark Application

VICTOR REINZ

(511) 17

(210) No. 54005

(220) 11/02/2026

(732) Mr. Lihua Zhang

No. 277, Xiangyuan New Village, Changsha
Street Office, Kaiping City, Guangdong
Province, China.

(540) Trademark Application



(511) 30

(210) No. 54006

(220) 11/02/2026

(732) CACAOVIA GROUP SDN. BHD.

No. 14, Jalan Firma 2/1, Kawasan
Perindustrian Tebrau 1, 81100 Johor Bahru,
Johor, Malaysia.

(540) Trademark Application



(511) 01, 17, 19 and 37

(210) No. 54007

(220) 12/02/2026

(732) QUALIBIT CHEMICALS & INDUSTRIES
SDN. BHD.

No. 52A, Jalan Anggerik Vanilla Z 31 / Z,
Kota Kemuning, 40460 Shah Alam, Selangor
Darul Ehsan, Malaysia.

(540) Trademark Application



(511) 10

(210) No. 54008

(220) 12/02/2026

(732) Li Zhaojiao

Rm 2D, Building 10, Xiangyu Central
Garden, No. 66, Nongyuan Road, Futian
District, Shenzhen, China.

(540) Trademark Application



(511) 42

(210) No. 54009

(220) 12/02/2026

(732) Shenzhen Gwell Times Technology Co., Ltd.
room 01-04, 28th floor, Block C of Minzhi
stock business center, Minzhi street, Longhua
district, Shenzhen, Guangdong, China.

(540) Trademark Application

yoosee

(511) 42

(210) No. 54010

(220) 12/02/2026

(732) Shenzhen Gwell Times Technology Co., Ltd.
room 01-04, 28th floor, Block C of Minzhi
stock business center, Minzhi street, Longhua
district, Shenzhen, Guangdong, China.

(540) Trademark Application



(511) 29

(210) No. 54011

(220) 12/02/2026

(732) Farm Fresh Berhad

No. 11-1, Jalan Petaling, Kawasan
Perindustrian Larkin, 80350 Johor Bahru,
Johor, Malaysia.

(540) Trademark Application

YASSO

(511) 30

(210) No. 54012

(220) 12/02/2026

(732) Magnum IP Holdings B.V.

Reguliersdwarsstraat 63, Amsterdam
1017BK, The Netherlands.

(540) Trademark Application

**Beauty
Buffet**

(511) 03 and 35

(210) No. 54013

(220) 12/02/2026

(732) Beauty Community Public Company Limited
50/1-3 Nuanchan 34 Alley, Nuanchan Sub-
district, Buengkum district, Bangkok 10230,
Thailand.

(540) Trademark Application

CLEW

(511) 05 and 34

(210) No. 54014

(220) 13/02/2026

(732) Novanic Labs Private Limited
D-28, Third Floor, Defence Colony,
New Delhi, 110 024, India.

(540) Trademark Application



(511) 10

(210) No. 54015

(220) 13/02/2026

(732) Yiwu Winning Star Supply Chain

Management Co., Ltd

Rm.1207, No.999 Chouzhou North Road,

Yiwu City, Zhejiang, China.

(540) Trademark Application



(511) 32

(210) No. 54016

(220) 16/02/2026

(732) ບໍລິສັດ ຜາຕັ້ງ ນໍ້າຕົ້ມແຮ່ທາດ ຈໍາກັດ.

ບ້ານ ຮ່ອງໄກ່ແກ້ວ, ເມືອງ ຈັນທະບູລີ,

ນະຄອນຫຼວງວຽງຈັນ, ສປປ ລາວ

(540) Trademark Application



ຈຳຫນ່າຍເຄື່ອງ ແລະ ຄຸປະກອນໄຟຟ້າພ້ອມລະບົບຫລັງບ້ານ
ແລະ ການບໍລິການຄົບວົງຈອນ

(511) 35

(210) No. 54017

(220) 16/02/2026

(732) ບໍລິສັດ ເອັນບີ ບໍລິການ ຈຳກັດຜູ້ດຽວ.

ບ້ານ ໂຊກຄຳ, ເມືອງ ໄຊເສດຖາ,
ນະຄອນຫຼວງວຽງຈັນ, ສປປ ລາວ

(540) Trademark Application



HANZHEN
韩真

(511) 35

(210) No. 54018

(220) 16/02/2026

(732) ບໍລິສັດ ພອຍໄຟລິນ ການຄ້າ ຂາເຂົ້າ-ຂາອອກ
ຈຳກັດຜູ້ດຽວ.

ບ້ານ ໂພນປາເປົ້າ, ເມືອງ ສີສັດຕະນາກ,
ນະຄອນຫຼວງວຽງຈັນ, ສປປ ລາວ

(540) Trademark Application



(511) 03

(210) No. 54019

(220) 16/02/2026

(732) ບໍລິສັດ ຊານຈຽງ ການຄ້າສາກົນ ຈຳກັດ
ບ້ານວັດໄຕນ້ອຍທົ່ງ, ເມືອງສີໂຄດຕະບອງ,
ນະຄອນຫຼວງວຽງຈັນ, ສປປ ລາວ

(540) Trademark Application



(511) 12

(210) No. 54020

(220) 17/02/2026

(732) ບໍລິສັດ ແຈດສ ໂອໂຕ (ລາວ) ຈຳກັດຜູ້ດຽວ
ບ້ານ ນາສ້ຽວ, ເມືອງ ນາຊາຍທອງ,
ນະຄອນຫຼວງວຽງຈັນ, ສປປ ລາວ

(540) Trademark Application



(511) 43

(210) No. 54021

(220) 17/02/2026

(732) ບໍລິສັດ ຮ້ານອາຫານແລນທາຍ ຈຳກັດຜູ້ດຽວ.

ບ້ານ ໜອງຈັນ, ເມືອງ ສີສັດຕະນາກ,

ນະຄອນຫຼວງວຽງຈັນ, ສປປ ລາວ

(540) Trademark Application



(511) 35

(210) No. 54022

(220) 18/02/2026

(732) ບໍລິສັດ ເອັດ ປີໂຕລ໌ຽມ ຈຳກັດ

ບ້ານ ດົງຊຽງດີ, ເມືອງ ນາຊາຍທອງ,

ນະຄອນຫຼວງວຽງຈັນ, ສປປ ລາວ

(540) Trademark Application



(511) 05

(210) No. 54023

(220) 18/02/2026

(732) ບໍລິສັດ ຫຼໍ່ ການຄ້າ ຂາເຂົ້າ-ຂາອອກ ຈຳກັດຜູ້ດຽວ
ບ້ານ ໜອງດ້ວງເໜືອ, ເມືອງ ສີໂຄດຕະບອງ,
ນະຄອນຫຼວງວຽງຈັນ, ສປປ ລາວ

(540) Trademark Application



(511) 05

(210) No. 54024

(220) 18/02/2026

(732) ບໍລິສັດ ຫຼໍ່ ການຄ້າ ຂາເຂົ້າ-ຂາອອກ ຈຳກັດຜູ້ດຽວ
ບ້ານ ໜອງດ້ວງເໜືອ, ເມືອງ ສີໂຄດຕະບອງ,
ນະຄອນຫຼວງວຽງຈັນ, ສປປ ລາວ

(540) Trademark Application



(511) 05

(210) No. 54025

(220) 18/02/2026

(732) ບໍລິສັດ ຫຸລີ້ ການຄ້າ ຂາເຂົ້າ-ຂາອອກ ຈຳກັດຜູ້ດຽວ
ບ້ານ ໜອງດ້ວງເໜືອ, ເມືອງ ສີໂຄດຕະບອງ,
ນະຄອນຫຼວງວຽງຈັນ, ສປປ ລາວ

(540) Trademark Application



(511) 01

(210) No. 54026

(220) 18/02/2026

(732) ບໍລິສັດ ເທບນິດາພາໂຊກ ທີ່ປຶກສາດ້ານກະສະກຳ ແລະ
ສິ່ງແວດລ້ອມ ຈຳກັດຜູ້ດຽວ
ບ້ານ ໂພນປາເປົ້າ, ເມືອງ ສີສັດຕະນາກ,
ນະຄອນຫຼວງວຽງຈັນ, ສປປ ລາວ

(540) Trademark Application



(511) 35

(210) No. 54027

(220) 18/02/2026

(732) ບໍລິສັດ ລາວ ອິນຕີເກຣດເຕັດ ຝໍເຣດຕຣີ ໂສລູຊັນສ໌
ຈຳກັດຜູ້ດຽວ
ບ້ານ ໂພນໄຊ, ເມືອງ ໄຊເສດຖາ,
ນະຄອນຫຼວງວຽງຈັນ, ສປປ ລາວ

(540) Trademark Application



(511) 43

(210) No. 54028

(220) 18/02/2026

(732) ວິສາຫະກິດສ່ວນບຸກຄົນ ຮ້ານ ຄົວຫຼວງ
ບ້ານ ທົ່ງກາງ, ເມືອງ ສີສັດຕະນາກ,
ນະຄອນຫຼວງວຽງຈັນ, ສປປ ລາວ.

(540) Trademark Application



(511) 12

(210) No. 54029

(220) 19/02/2026

(732) ບໍລິສັດ ກາງຫາວ ບໍລິການເສດຖະກິດດ້ວຍໂດຣນ
ຈໍາກັດ.

ບ້ານ ວັດໄຕນ້ອຍທົ່ງ, ເມືອງ ສີໂຄດຕະບອງ,
ນະຄອນຫຼວງວຽງຈັນ, ສປປ ລາວ

(540) Trademark Application



(511) 25 and 35

(210) No. 54030

(220) 19/02/2026

(732) ວິສາຫະກິດສ່ວນບຸກຄົນ ຮ້ານ ບ້ານຍ່າ ຜ້າຝ້າຍ ແລະ
ເຄື່ອງຫັດຖະກໍາ

ບ້ານ ສີສະຫວາດ, ເມືອງ ຈັນທະບູລີ,
ນະຄອນຫຼວງວຽງຈັນ, ສປປ ລາວ.

(540) Trademark Application



(511) 12

(210) No. 54032

(220) 19/02/2026

(732) ບໍລິສັດ ໂບດົງປະກອບລົດຈັກແລະເຄື່ອງຈັກກະສິກໍາ
ຂາເຂົ້າ-ຂາອອກ ຈໍາກັດຜູ້ດຽວ
ບ້ານ ຊຸ້, ເມືອງ ສິງ, ແຂວງ ຫຼວງນໍ້າທາ, ສປປ ລາວ.

(540) Trademark Application



(511) 29

(210) No. 54033

(220) 19/02/2026

(732) Mooyor Parly Food Factory Individual
Oudomphon Village, Xaythany District,
Vientiane Capital, Xaythany.

(540) Trademark Application

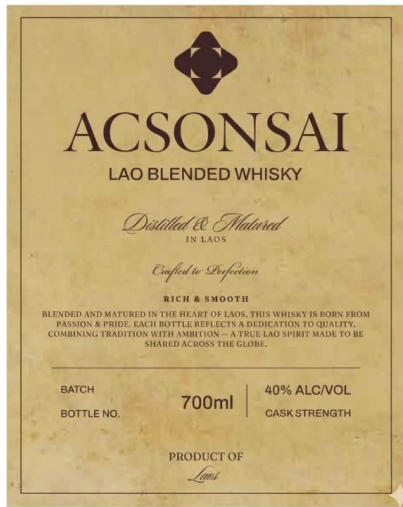

(511) 33

(210) No. 54034

(220) 20/02/2026

(732) ບໍລິສັດ ອິນເຕີ ສະບີຣິດສ໌ (ລາວ) ຈຳກັດ
ບ້ານໜອງດ້ວງ, ເມືອງສີໂຄດຕະບອງ,
ນະຄອນຫຼວງວຽງຈັນ, ສປປ ລາວ

(540) Trademark Application



(511) 33

(210) No. 54035

(220) 20/02/2026

(732) ບໍລິສັດ ອິນເຕີ ສະບີຣິດສ໌ (ລາວ) ຈຳກັດ
ບ້ານໜອງດ້ວງ, ເມືອງສີໂຄດຕະບອງ,
ນະຄອນຫຼວງວຽງຈັນ, ສປປ ລາວ

(540) Trademark Application



(511) 30

(210) No. 54036

(220) 20/02/2026

(732) ບໍລິສັດ ປຸງແຕ່ງແປ້ງມັນຕົ້ນ ຕະໂອ້ຍ ຈຳກັດຜູ້ດຽວ
ຖະໜົນເລກທີ 15B, ບ້ານ ປະງານດາວ,
ເມືອງ ຕະໂອ້ຍ, ແຂວງ ສາລະວັນ, ສປປ ລາວ

(540) Trademark Application



(511) 41

(210) No. 54037

(220) 20/02/2026

(732) ສຸນຝິກ ທັກສະ ຈຳກັດຜູ້ດຽວ.
ບ້ານ ໂພນປ່າເປົ້າ, ເມືອງ ສີສັດຕະນາກ,
ນະຄອນຫຼວງວຽງຈັນ, ສປປ ລາວ

(540) Trademark Application



(511) 01, 29 and 31

(210) No. 54038

(220) 20/02/2026

(732) ບໍລິສັດ ລາວ ວິຕາລິຕີ ໄບໂອເຕັກໂນໂລຊີ

ບ້ານ ໂພນປ່າເປົ້າ, ເມືອງ ສີສັດຕະນາກ,

ນະຄອນຫຼວງວຽງຈັນ, ສປປ ລາວ

(540) Trademark Application



(511) 30

(210) No. 54039

(220) 20/02/2026

(732) ບໍລິສັດ ຮຸ່ງໂຊກ ຈຳກັດຜູ້ດຽວ

ບ້ານ ໂພນປ່າເປົ້າ, ເມືອງ ສີສັດຕະນາກ,

ນະຄອນຫຼວງວຽງຈັນ, ສປປ ລາວ

(540) Trademark Application

Abacus Group

(511) 36

(210) No. 54040

(220) 20/02/2026

(732) ບໍລິສັດ ເອກແວນກາດ ຈຳກັດ.

ບ້ານ ສີຫອມ, ເມືອງ ຈັນທະບູລີ,
ນະຄອນຫຼວງວຽງຈັນ, ສປປ ລາວ

(540) Trademark Application

Abacus Estates

(511) 36

(210) No. 54041

(220) 20/02/2026

(732) ບໍລິສັດ ເອກແວນກາດ ຈຳກັດ.

ບ້ານ ສີຫອມ, ເມືອງ ຈັນທະບູລີ,
ນະຄອນຫຼວງວຽງຈັນ, ສປປ ລາວ

(540) Trademark Application

Abacus Securities

(511) 36

(210) No. 54042

(220) 20/02/2026

(732) ບໍລິສັດ ເອກແວນກາດ ຈຳກັດ.

ບ້ານ ສີຫອມ, ເມືອງ ຈັນທະບູລີ,
ນະຄອນຫຼວງວຽງຈັນ, ສປປ ລາວ

(540) Trademark Application

Abacus Finance

(511) 36

(210) No. 54043

(220) 20/02/2026

(732) ບໍລິສັດ ເອກແວນກາດ ຈຳກັດ.

ບ້ານ ສີຫອມ, ເມືອງ ຈັນທະບູລີ,
ນະຄອນຫຼວງວຽງຈັນ, ສປປ ລາວ

(540) Trademark Application

Abacus Suite

(511) 36

(210) No. 54044

(220) 20/02/2026

(732) ບໍລິສັດ ເອກແວນກາດ ຈຳກັດ.

ບ້ານ ສີຫອມ, ເມືອງ ຈັນທະບູລີ,
ນະຄອນຫຼວງວຽງຈັນ, ສປປ ລາວ

(540) Trademark Application

Abacus Capital

(511) 36

(210) No. 54045

(220) 20/02/2026

(732) ບໍລິສັດ ເອກແວນກາດ ຈຳກັດ.

ບ້ານ ສີຫອມ, ເມືອງ ຈັນທະບູລີ,
ນະຄອນຫຼວງວຽງຈັນ, ສປປ ລາວ

(540) Trademark Application



(511) 24

(210) No. 54047

(220) 20/02/2026

(732) ວິສາຫະກິດ ສູນສິ່ງເສີມທັດຖະກຳ ເຮືອນຫຼັກມິຕຸນາ
ບ້ານ ວຽງເໜືອ, ເມືອງ ຫຼວງນ້ຳທາ,
ແຂວງ ຫຼວງນ້ຳທາ, ສປປ ລາວ

(540) Trademark Application

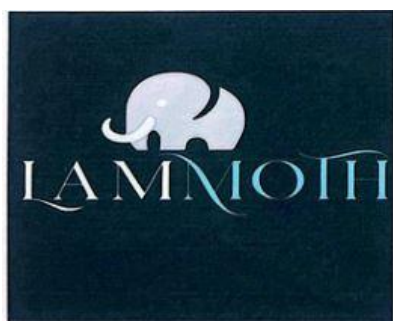

(511) 25

(210) No. 54048

(220) 20/02/2026

(732) ທ່ານ ຮວງຍິງຊ້ອກ
ບ້ານ ໂພນງາມໃຕ້ ເມືອງແປກ ແຂວງ ຊຽງຂວາງ,
ສປປ ລາວ

(540) Trademark Application

CARKU

(511) 09

(210) No. 54049

(220) 23/02/2026

(732) Shenzhen Carku Technology Co., Ltd.

No. 103, Block A, Qixing Creative Factory,
Gaofeng Community, Dalang Street, Longhua
District, Shenzhen, China.

(540) Trademark Application

code glokolor

(511) 03

(210) No. 54050

(220) 23/02/2026

(732) LG H&H Co., LTD.

98, Huam-ro, Jung-gu, Seoul,
Republic of Korea.

(540) Trademark Application

The logo for CARKU features the word "CARKU" in a bold, italicized, sans-serif font. The letter "A" is stylized with a triangular shape inside it.

(511) 09

(210) No. 54051

(220) 23/02/2026

(732) Shenzhen Carku Technology Co., Ltd.
No. 103, Block A, Qixing Creative Factory,
Gaofeng Community, Dalang Street,
Longhua District, Shenzhen, China.

(540) Trademark Application

The logo for FRENCH AVENUE consists of the words "FRENCH" and "AVENUE" stacked vertically in a bold, sans-serif font. The letter "A" in "AVENUE" is stylized with a triangular shape inside it.

(511) 03

(210) No. 54052

(220) 23/02/2026

(732) French Avenue General Trading L.L.C
P.O. Box 6629, Dubai, United Arab Emirates.

(540) Trademark Application



(511) 03

(210) No. 54053

(220) 23/02/2026

(732) Fragrance World Trading L.L.C

P.O. Box 6629, Dubai, United Arab Emirates.

(540) Trademark Application



(511) 03

(210) No. 54054

(220) 23/02/2026

(732) Fragrance World Trading L.L.C

P.O. Box 6629, Dubai, United Arab Emirates.

(540) Trademark Application



(511) 37 and 39

(210) No. 54055

(220) 24/02/2026

(732) ບໍລິສັດ ນໍ້າມັນເຊື້ອໄຟ ຄໍາແພວ ຈຳກັດຜູ້ດຽວ.

ບ້ານ ທົ່ງປິ່ງ, ເມືອງ ສີໂຄດຕະບອງ,

ນະຄອນຫຼວງວຽງຈັນ, ສປປ ລາວ

(540) Trademark Application



(511) 05

(210) No. 54057

(220) 24/02/2026

(732) ບໍລິສັດ ຕຸກຕາ ສະກິນແຄຣ ຂາອອກ-ຂາດຂ້າ

ຈຳກັດຜູ້ດຽວ

ບ້ານ ວັງກ້ານຮຸ່ງ ເມືອງຄົງເຊໂດນ ແຂວງສາລະວັນ,

ສປປ ລາວ

(540) Trademark Application

Caederon

(511) 34

(210) No. 54059

(220) 24/02/2026

(732) HONG KONG LVL (GROUP) TOBACCO
CO., LIMITED

Room 1009, 10/F, Front Block, Ming Sang
Industrial Building, 19 Hing Yip Street,
Kwun Tong, Kowloon, Hong Kong.

(540) Trademark Application

VAT 69

(511) 33

(210) No. 54060

(220) 25/02/2026

(732) Diageo Brands B.V.

Molenwerf 12, 1014 BG Amsterdam,
The Netherlands.

(540) Trademark Application



(511) 16

(210) No. 54063

(220) 26/02/2026

(732) Anhui Shu'aixiong Technology Co., Ltd.

No. 228, Suntang Road, Xianghe Town,
Quanjiao County, Chuzhou City, Anhui
Province, China.

(540) Trademark Application

VISTONY

(511) 01, 03 and 04

(210) No. 54064

(220) 26/02/2026

(732) VISTONY COMPAÑIA INDUSTRIAL DEL
PERU S.A.C.

Mza. B1 Lote. 01 Parque Industrial de
AnconAcompia (Alt. Km. 46. 5 Pan. Norte),
Peru.

(540) Trademark Application

GLORY

(511) 05, 25 and 35

(210) No. 54065

(220) 26/02/2026

(732) GLORY OFFICIAL CO., LTD.

99/202 Anasiri-Bangyai Village, Moo 7,
Bang Mae Nang, Bang Yai, Nonthaburi,
11140, Thailand.

(540) Trademark Application

อายิโนะโมะโต๊ะ พลาสติก

(511) 30

(210) No. 54066

(220) 26/02/2026

(732) Ajinomoto Co., Inc.

15-1, Kyobashi 1-chome, Chuo-ku, Tokyo,
Japan.

(540) Trademark Application



(511) 32

(210) No. 54067

(220) 26/02/2026

(732) PepsiCo, Inc.

700 Anderson Hill Road, Purchase,
New York 10577, United States of America.

(540) Trademark Application



(511) 32

(210) No. 54068

(220) 26/02/2026

(732) PepsiCo, Inc.

700 Anderson Hill Road, Purchase,
New York 10577, United States of America.

(540) Trademark Application



(511) 32

(210) No. 54069

(220) 26/02/2026

(732) INNOVATIVE FOOD AND BEVERAGE
PTE. LTD.

6 Battery Road, #03-01, Six Battery Road,
049909 , Singapore.

(540) Trademark Application



(511) 11

(210) No. 54070

(220) 26/02/2026

(732) Guangdong Welly Electrical Appliances Co.,
Ltd.

Fusha Industrial Park, Fusha Town,
Zhongshan City, Guangdong Province,
China.

(540) Trademark Application

**THE STARBUCKS
COFFEE COMPANY**

(511) 16, 18, 21, 25, 29, 30, 32, 35, 41 and 43

(210) No. 54071

(220) 27/02/2026

(732) Starbucks Corporation

2401 Utah Avenue South, Seattle,

Washington, 98134,

United States of America.

(540) Trademark Application



(511) 21, 29, 30, 32, 35 and 43

(210) No. 54072

(220) 27/02/2026

(732) Starbucks Corporation

2401 Utah Avenue South, Seattle,

Washington, 98134,

United States of America.

(540) Trademark Application



(511) 21, 29, 30, 32, 35 and 43

(210) No. 54073

(220) 27/02/2026

(732) Starbucks Corporation

2401 Utah Avenue South, Seattle,
Washington, 98134,
United States of America.

(540) Trademark Application



(511) 35

(210) No. 54074

(220) 27/02/2026

(732) DAIKIN INDUSTRIES, LTD.

Osaka Umeda Twin Towers South, 1-13-1,
Umeda, Kita-ku, Osaka-Shi, Osaka, Japan.

ພາກທີ III

(Part III)

ເຄື່ອງໝາຍການຄ້າ

Trademarks

2. ຜົນການຈົດທະບຽນ

(Registration)

ຄຳອະທິບາຍກ່ຽວກັບລະຫັດຫຍໍ້

(Introduction of Codes)

- (540) ເຄື່ອງໝາຍການຄ້າ (Trademark)
- (511) ໝວດ (Nice Classification)
- (210) ເລກທີ ຄຳຮ້ອງ (Number of the application)
- (220) ວັນທີ ຄຳຮ້ອງ (Date of filing of the application)
- (732) ຊື່ ແລະ ທີ່ຢູ່ ຂອງຜູ້ຍື່ນຄຳຮ້ອງ (Name and Address of applicant)
- (111) ເລກທີ ການຈົດທະບຽນເຄື່ອງໝາຍການຄ້າ (Number of the registration)
- (180) ວັນໝົດອາຍຸຂອງການຈົດທະບຽນ (Expiration date of the registration)

(540) Registration



(511) 25

(210) No. 52231

(220) 08/05/2025

(732) ທ່ານ ອະພິຊາດ ຜູດພິມ

ບ້ານ ສຸນັນທາ, ນະຄອນໄກສອນພິມວິຫານ,

ແຂວງ ສະຫວັນນະເຂດ, ສປປ ລາວ

(111) No. 67565

(180) 08/05/2035

(540) Registration



(511) 06, 07, 08, 09, 11, 17, 35, 36 and 39

(210) No. 52414

(220) 05/06/2025

(732) Foshan Dazhuan Bay Baiqi Information
Technology Co., Ltd.

No. 7, 10th Floor, Building 1, No. 80,

Guangfo Shinkansen, Dali Town, Nanhai

District, Foshan City, Guangdong Province,

China

(111) No. 67566

(180) 05/06/2035

(540) Registration



(511) 25 and 35

(210) No. 52413

(220) 05/06/2025

(732) ZANDO CO., LTD.

Building No. 113C (Second Floor 2F U08 & U09), Mao Tse Toung Blvd., Phum 7, Sangkat Tuol Svay Prey I, Khan Boeng Keng Kang, Phnom Penh, Cambodia

(111) No. 67567

(180) 05/06/2035

(540) Registration



(511) 12

(210) No. 52412

(220) 05/06/2025

(732) Shandong Linglong Tyre Co., Ltd.

No.777 Jinlong Road, Zhaoyuan City 265400 Shandong Province, China

(111) No. 67568

(180) 05/06/2035

(540) Registration



(511) 25

(210) No. 52405

(220) 02/06/2025

(732) Hangzhou Xiyu Camel Brand Management
Co., Ltd

Room 1109, Block A, Wufutianxinglong
Building, No. 358 Fengqi East Road,
Shangcheng District, Hangzhou City,
Zhejiang Province, China

(111) No. 67569

(180) 02/06/2035

(540) Registration



(511) 29

(210) No. 52404

(220) 02/06/2025

(732) FrieslandCampina Nederland B.V.

Stationsplein 4, 3818 LE AMERSFOORT,
The Netherlands

(111) No. 67570

(180) 02/06/2035

(540) Registration

The logo for 'Falcon' is written in a bold, black, sans-serif font. The letters are slightly slanted to the right, giving it a dynamic feel.

(511) 29

(210) No. 52403

(220) 02/06/2025

(732) FrieslandCampina Nederland B.V.

Stationsplein 4, 3818 LE AMERSFOORT,
The Netherlands

(111) No. 67571

(180) 02/06/2035

(540) Registration

The logo for 'MOVENET' is written in a bold, black, sans-serif font. The letter 'E' is stylized with a horizontal line through its center.

(511) 09

(210) No. 52446

(220) 12/06/2025

(732) ZCHWANTECH SDN. BHD.

No. 8, Jalan SS21/37 Damansara Uptown
47400, Petaling Jaya Selangor Darul Ehsan,
Malaysia

(111) No. 67572

(180) 12/06/2035

(540) Registration

棉猫咪
MIANMAOMI

(511) 25

(210) No. 52444

(220) 11/06/2025

(732) Hangzhou Cotton Cat Brand Management
Co., Ltd.

Rm. 407, Bldg. 2, No.1 Longquan Rd.,
Cangqian St., Yuhang Dist., Hangzhou,
Zhejiang, China

(111) No. 67573

(180) 11/06/2035

(540) Registration

野口

(511) 05

(210) No. 52097

(220) 21/04/2025

(732) ໂຮງງານຜະລິດຢາລາວ

ເຂດເສດຖະກິດບໍ່ແຕ່ນແດນງາມ, ແຂວງ ຫຼວງນໍ້າທາ,

ສປປ ລາວ

(111) No. 67574

(180) 21/04/2035

(540) Registration

Bestsnac

(511) 35

(210) No. 52425

(220) 06/06/2025

(732) Hunan Snacks Premium Brand Management
Co., Ltd.

Rm 516-346, 5/F, Huanghua FTZ Exhibition
Center, Changsha, Hunan, China

(111) No. 67575

(180) 06/06/2035

(540) Registration

PLEY BY NEY

(511) 32

(210) No. 52422

(220) 05/06/2025

(732) Fun Brands LLC

6663 Casa Grande Way, Delray Beach, Florida
33446, United States of America

(111) No. 67576

(180) 05/06/2035

(540) Registration

PLEY

(511) 32

(210) No. 52421

(220) 05/06/2025

(732) Fun Brands LLC

6663 Casa Grande Way, Delray Beach, Florida
33446, United States of America

(111) No. 67577

(180) 05/06/2035

(540) Registration



(511) 02

(210) No. 52420

(220) 05/06/2025

(732) Liu Yanming

No. 9, Group 9, Sangshuba Village, Jingxi
Street, Shunqing District, Nanchong City,
Sichuan Province, China

(111) No. 67578

(180) 05/06/2035

(540) Registration

The logo consists of the Thai word 'นันท์' (Nanth) written in a stylized, black, sans-serif font. The characters are bold and have a slight shadow effect.

(511) 05

(210) No. 52419

(220) 05/06/2025

(732) PUKHA TRADEYA CO., LTD.

36, Mu 8, Fai Kaeo Sub-district, Phu Phiang
District, Nan Province 55000, Thailand

(111) No. 67579

(180) 05/06/2035

(540) Registration

The logo consists of the word 'NANTH' in a bold, black, sans-serif font. Each letter is contained within a separate black rectangular box, and the boxes are arranged horizontally.

(511) 05

(210) No. 52418

(220) 05/06/2025

(732) PUKHA TRADEYA CO., LTD.

36, Mu 8, Fai Kaeo Sub-district, Phu Phiang
District, Nan Province 55000, Thailand

(111) No. 67580

(180) 05/06/2035

(540) Registration

NANTH

(511) 05

(210) No. 52417

(220) 05/06/2025

(732) PUKHA TRADEYA CO., LTD.

36, Mu 8, Fai Kaeo Sub-district, Phu Phiang
District, Nan Province 55000, Thailand

(111) No. 67581

(180) 05/06/2035

(540) Registration



(511) 43

(210) No. 52416

(220) 05/06/2025

(732) SUNPARK HOLDINGS PTE. LTD.

1 NORTH BRIDGE ROAD, #06-36, HIGH
STREET CENTRE, SINGAPORE 179094

(111) No. 67582

(180) 05/06/2035

(540) Registration

广佛国际机电五金城
Guang Fo international MEP & Hardware Plaza
ກວາງຝຣັດວິນາຍເມັດກັບອັກຄະໄປລິນອາກິນ ຄະ ຊຸນວອນອາກັດ

(511) 09, 35, 36 and 39

(210) No. 52415

(220) 05/06/2025

(732) Foshan Dazhuan Bay Baiqi Information
Technology Co., Ltd.

No. 7, 10th Floor, Building 1, No. 80,
Guangfo Shinkansen, Dali Town, Nanhai
District, Foshan City, Guangdong Province,
China

(111) No. 67583

(180) 05/06/2035

(540) Registration

SHINSEGAE
D U T Y F R E E

(511) 35

(210) No. 52442

(220) 11/06/2025

(732) SHINSEGAE Inc.

63, Sogong-ro, Jung-gu, Seoul,
Republic of Korea

(111) No. 67584

(180) 11/06/2035

(540) Registration

Mother's Nutritaste

(511) 29 and 30

(210) No. 52441

(220) 11/06/2025

(732) YANGSHENGTANG CO., LTD.

3rd Floor, 3rd Building, Xiatong Street,
Shuangpu Town, Xihu District, Hangzhou
City, Zhejiang Province, China

(111) No. 67585

(180) 11/06/2035

(540) Registration

HERCURO

(511) 04

(210) No. 52440

(220) 10/06/2025

(732) Bangchak Corporation Public Company
Limited

2098 M Tower Building, 8th Floor,
Sukhumvit Road, Phra Khanong Tai, Phra
Khanong, Bangkok 10260, Thailand

(111) No. 67586

(180) 10/06/2035

(540) Registration



(511) 04
(210) No. 52439
(220) 10/06/2025
(732) Bangchak Corporation Public Company
Limited
2098 M Tower Building, 8th Floor,
Sukhumvit Road, Phra Khanong Tai, Phra
Khanong, Bangkok 10260, Thailand
(111) No. 67587
(180) 10/06/2035

(540) Registration

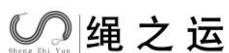

(511) 14
(210) No. 52438
(220) 10/06/2025
(732) Guangdong Diamond Wharf Jewelry Co.,
Ltd.
103, Building B, Shenhua Liyuan, No. 76
Shuibe 1st Road, Cuijin Community, Cuizhu
Street, Luohu District, Shenzhen City,
Guangdong Province, China
(111) No. 67588
(180) 10/06/2035

(540) Registration

EUROKLIMAT

(511) 11

(210) No. 52437

(220) 09/06/2025

(732) EUROKLIMAT (ASIA PACIFIC) LIMITED

19/F KAM FUNG COMMERCIAL

BUILDING 2-4 TIN LOK LANE WAN

CHAI, HONG KONG

(111) No. 67589

(180) 09/06/2035

(540) Registration

MEW

(511) 34

(210) No. 52431

(220) 09/06/2025

(732) KIMWIN BRANDS INC.

OMC Chambers, Wickhams Cay 1, Road

Town, Tortola, British Virgin Islands

(111) No. 67590

(180) 09/06/2035

(540) Registration



(511) 17

(210) No. 52426

(220) 06/06/2025

(732) Huizhou Zhengchuan Chemical Industry
Hose Co., LTD

1st Floor, Building F, Dongtai Industrial
Park, Xiaopenggang Village, Longxi Sub-
district, Boluo County, Huizhou City, China

(111) No. 67591

(180) 06/06/2035

(540) Registration



(511) 09, 35, 36, 41 and 42

(210) No. 52507

(220) 22/06/2025

(732) The Trustees of the PwC Business Trust
300 Madison Avenue, New York 10017,
United States of America

(111) No. 67592

(180) 22/06/2035

(540) Registration

潮汕良心果汁

(511) 43

(210) No. 52506

(220) 20/06/2025

(732) Zhang Mianhao

No. 2, Building 5, Lane 4, South Market
Road, Daitou Village, Xinan Town, Chenghai
District, Shantou City, Guangdong Province,
China

(111) No. 67593

(180) 20/06/2035

(540) Registration

HOZE

(511) 30

(210) No. 52505

(220) 20/06/2025

(732) Sichuan Shenrong Baishixing Food Co., LTD

No. 388 Shuyun Road, Sichuan Cuisine
Industrial Town, Ande Street, Pidu District,
Chengdu City, Sichuan Province, China

(111) No. 67594

(180) 20/06/2035

(540) Registration

EWEADN

(511) 09

(210) No. 52504

(220) 20/06/2025

(732) Jiangxi pioneer electronic Technology Co.,
LTD

Room 12D, 10th Floor, Qingshanhu

Entrepreneurial Building, 1616 East Beijing

Road, Qingshanhu District, Nanchang City,

Jiangxi Province, China

(111) No. 67595

(180) 20/06/2035

(540) Registration

FATINY

(511) 03

(210) No. 52501

(220) 20/06/2025

(732) Guangzhou Zhiyue Brand Management Co.,
Ltd.

Room 506, Building C2, No. 27-2,

Yuanxiatian 4th Road, Yongtai, Yongping

Street, Baiyun District, Guangzhou, China

(111) No. 67596

(180) 20/06/2035

(540) Registration

MiöBuss

(511) 35

(210) No. 52500

(220) 19/06/2025

(732) Hunan Xuanlin International Trade Co., Ltd.
ROOM 8411 - 13, FLOOR 4, BUILDING 4,
NO.369, SECTION 1, XIANGJIANG
NORTH ROAD QINGZHUUH STREET,
KAIFU DISTRICT, CHANGSHA, HUNAN,
CHINA

(111) No. 67597

(180) 19/06/2035

(540) Registration

DOVER

(511) 07, 09 and 37

(210) No. 52499

(220) 19/06/2025

(732) Delaware Capital Formation, Inc.
501 Silverside Road, Suite 5, Wilmington,
Delaware 19809, United States of America

(111) No. 67598

(180) 19/06/2035

(540) Registration



(511) 02

(210) No. 52498

(220) 19/06/2025

(732) Guangzhou Xiushen E-commerce Co., Ltd.

Room 209, Building F, Yuanlifang Creative
Park, Jiahewanggang, Baiyun District,
Guangzhou City, Guangdong Province, China

(111) No. 67599

(180) 19/06/2035

(540) Registration



(511) 29

(210) No. 52497

(220) 19/06/2025

(732) JINZAI FOOD GROUP CO.,LTD.

Pingjiang High-tech Industrial Park, Yueyang
City, Hunan Province, China

(111) No. 67600

(180) 19/06/2035

(540) Registration

*The*LUXURY SECRET

(511) 03

(210) No. 52517

(220) 23/06/2025

(732) GUANGZHOU UMORSEA INVESTMENT
HOLDING CO., LTD.

Room 1622, No. 395 Jianpeng Road, Baiyun
District, Guangzhou, Guangdong Province,
China

(111) No. 67601

(180) 23/06/2035

(540) Registration

UMORSÉA

(511) 03

(210) No. 52516

(220) 23/06/2025

(732) GUANGZHOU UMORSEA INVESTMENT
HOLDING CO., LTD.

Room 1622, No. 395 Jianpeng Road, Baiyun
District, Guangzhou, Guangdong Province,
China

(111) No. 67602

(180) 23/06/2035

(540) Registration

NOVAPASSWORD

(511) 03

(210) No. 52515

(220) 23/06/2025

(732) GUANGZHOU UMORSEA INVESTMENT
HOLDING CO., LTD.

Room 1622, No. 395 Jianpeng Road, Baiyun
District, Guangzhou, Guangdong Province,
China

(111) No. 67603

(180) 23/06/2035

(540) Registration



(511) 01 and 17

(210) No. 52514

(220) 23/06/2025

(732) NINGBO PASCO UNITED INDUSTRY
CO., LTD.

Yao Bei Industrial New Area, Yuyao City,
Zhejiang, China

(111) No. 67604

(180) 23/06/2035

(540) Registration



LS
LESASHA

(511) 03, 08, 11 and 21

(210) No. 52513

(220) 23/06/2025

(732) Do Day Dream Public Company Limited

32 Keharomklao Road, Ratpattana,

Saphansung, Bangkok 10240, Thailand

(111) No. 67605

(180) 23/06/2035

(540) Registration



ALCAZAR

(511) 12

(210) No. 52512

(220) 23/06/2025

(732) HYUNDAI MOTOR COMPANY

12, Heolleung-ro, Seocho-gu, Seoul, 06797,

Republic of Korea

(111) No. 67606

(180) 23/06/2035

(540) Registration

LIGHT AND NIGHT

(511) 09, 41 and 42

(210) No. 52511

(220) 23/06/2025

(732) Tencent Holdings Limited

P.O. Box 2681 GT, Century Yard, Cricket
Square, Hutchins Drive, George Town, Grand
Cayman, Cayman Islands

(111) No. 67607

(180) 23/06/2035

(540) Registration



(511) 12 and 35

(210) No. 52521

(220) 24/06/2025

(732) ບໍລິສັດ ຫຼີງຝາຈະເລີນຍົນ ຈຳກັດຜູ້ດຽວ

ບ້ານ ອາກາດ, ເມືອງ ສີໂຄດຕະບອງ,

ນະຄອນຫຼວງວຽງຈັນ, ສປປ ລາວ

(111) No. 67608

(180) 24/06/2035

(540) Registration



(511) 12

(210) No. 52520

(220) 24/06/2025

(732) ບໍລິສັດ ຫົງຝ່າຈະເລີນຍົນ ຈຳກັດຜູ້ດຽວ

ບ້ານ ອາກາດ, ເມືອງ ສີໂຄດຕະບອງ,

ນະຄອນຫຼວງວຽງຈັນ, ສປປ ລາວ

(111) No. 67609

(180) 24/06/2035

(540) Registration



(511) 05

(210) No. 52509

(220) 23/06/2025

(732) ບໍລິສັດ ຮິວຊິນ ເນັດເວີກ ມິເດຍ ຈຳກັດຜູ້ດຽວ

ບ້ານ ອຸບມຸງ, ເມືອງ ສີໂຄດຕະບອງ,

ນະຄອນຫຼວງວຽງຈັນ, ສປປ ລາວ

(111) No. 67610

(180) 23/06/2035

(540) Registration



(511) 36

(210) No. 52503

(220) 20/06/2025

(732) ບໍລິສັດ ສະຖາບັນການເງິນຈຸລະພາກທີ່ບໍ່ຮັບເງິນຝາກເດີ

ຄາປິໂທຣ ພັສ ຈຳກັດຜູ້ດຽວ,

ບ້ານ ໂພນຕ້ອງສະຫວາດ, ເມືອງ ຈັນທະບູລີ,

ນະຄອນຫຼວງວຽງຈັນ, ສປປ ລາວ

(111) No. 67611

(180) 20/06/2035

(540) Registration

War of the Three Kingdoms: Chrono Wars

(511) 09 and 41

(210) No. 52572

(220) 30/06/2025

(732) Hangzhou Youka Network Technology Co.,
Ltd.

Room 12001, 12th Floor, Building A,

Tiantang Software Park, No. 3 Xidoumen

Road, Xihu District, Hangzhou, Zhejiang

Province, China

(111) No. 67612

(180) 30/06/2035

(540) Registration

WTK: Chrono Wars

(511) 09 and 41

(210) No. 52571

(220) 30/06/2025

(732) Hangzhou Youka Network Technology Co., Ltd.

Room 12001, 12th Floor, Building A, Tiantang
Software Park, No. 3 Xidoumen Road, Xihu
District, Hangzhou, Zhejiang Province, China

(111) No. 67613

(180) 30/06/2035

(540) Registration

MOODO BABY

(511) 05

(210) No. 52568

(220) 27/06/2025

(732) FUJIAN PROVINCE BESOA HYGIENE
PRODUCT CO., LTD.

FUMAO LING DEVELOPMENT ZONE,
SHENGXIN TOWN, NANAN CITY,
QUANZHOU CITY, FUJIAN PROVINCE,
CHINA

(111) No. 67614

(180) 27/06/2035

(540) Registration



(511) 12

(210) No. 52578

(220) 30/06/2025

(732) ບໍລິສັດ ໂຮດາ ການຄ້າ ຈຳກັດຜູ້ຄຽວ

ບ້ານ ໂພນໄຊ, ເມືອງ ໂພນໂຮງ, ເຂວງ ວຽງຈັນ, ສປປ ລາວ

(111) No. 67615

(180) 30/06/2035

(540) Registration



(511) 03

(210) No. 52574

(220) 30/06/2025

(732) Liu Ximei

Room 1206, No. 13, Baishun East Street,

Sanyuanli Avenue, Baiyun District,

Guangzhou, China

(111) No. 67616

(180) 30/06/2035

(540) Registration

CONLIN

(511) 09

(210) No. 52573

(220) 30/06/2025

(732) Shenzhen Xinshengjinming Technology Co., Ltd.

Room 101, Building 4, No. 1, Shangxue

Technology City, Xinxue Community,

Bantian Street, Longgang District, Shenzhen,

Guangdong, China

(111) No. 67617

(180) 30/06/2035

(540) Registration



(511) 12 and 36

(210) No. 52427

(220) 09/06/2025

(732) ບໍລິສັດ ນານຢາງ ການລົງທຶນ ຈໍາກັດຜູ້ດຽວ

ບ້ານ ບໍ່ປຽດ, ເມືອງ ຫຼວງນໍ້າທາ, ແຂວງ ຫຼວງນໍ້າທາ,

ສປປ ລາວ

(111) No. 67618

(180) 09/06/2035

(540) Registration



(511) 35

(210) No. 52430

(220) 09/06/2025

(732) ວິສາຫະກິດ ເດີວິບວິງສີສເຕີ ສ່ວນບຸກຄົນ
ບ້ານ ພັນຫຼວງ, ນະຄອນຫຼວງພະບາງ, ແຂວງ
ຫຼວງພະບາງ, ສປປ ລາວ

(111) No. 67619

(180) 09/06/2035

(540) Registration



(511) 32

(210) No. 52443

(220) 11/06/2025

(732) ວິສາຫະກິດສ່ວນບຸກຄົນ ໄຊໂຢ ໂຮງງານເຜີຍນໍ້າຕົ້ມບໍລິສຸດ
ບ້ານ ດົງຄຸນ, ເມືອງ ຫອງບຶກ, ແຂວງ ຄຳມ່ວນ, ສປປ ລາວ

(111) No. 67620

(180) 11/06/2035

(540) Registration



(511) 03

(210) No. 52428

(220) 09/06/2025

(732) ບໍລິສັດ ລາວ ໄດອາລີ ໄລ໌ ໂປຣຕັກ ຈຳກັດຜູ້ດຽວ

ບ້ານ ຫ້ວຍລົວ, ເມືອງ ເຊໂປນ, ແຂວງ

ສະຫວັນນະເຂດ, ສປປ ລາວ

(111) No. 67621

(180) 09/06/2035

(540) Registration



(511) 39 and 43

(210) No. 52478

(220) 18/06/2025

(732) ບໍລິສັດ ພູມາຍ ຝິເອັມ ທ່ອງທ່ຽວ ສາກົນ ຈຳກັດ

ບ້ານ ນາຄຳ, ເມືອງ ສີໂຄດຕະບອງ,

ນະຄອນຫຼວງວຽງຈັນ, ສປປ ລາວ

(111) No. 67622

(180) 18/06/2035

(540) Registration

FERLIKISS

(511) 01

(210) No. 52477

(220) 17/06/2025

(732) Sichuan Ruixiang Agricultural Science and
Technology Development Co., Ltd
Sichuan Meishan high-tech Industrial Park
(western district), China

(111) No. 67623

(180) 17/06/2035

(540) Registration

NANUKE

(511) 08 and 21

(210) No. 52476

(220) 17/06/2025

(732) Zhejiang Xianfeng Technology Co., Ltd.
Room 3107-2, Building 2, Zhonghai
Development Building, Xixing Street,
Binjiang District, Hangzhou City, Zhejiang
Province, China

(111) No. 67624

(180) 17/06/2035

(540) Registration



(511) 25, 28, 30, 35 and 41

(210) No. 52475

(220) 17/06/2025

(732) 7-Eleven International LLC

3200 Hackberry Road, Irving, Texas 75063,
United States of America

(111) No. 67625

(180) 17/06/2035

(540) Registration

(511) 35

(210) No. 52491

(220) 19/06/2025

(732) ALIBABA INNOVATION PRIVATE
LIMITED

51 Bras Basah Road, #03-06 Lazada One,
Singapore 189554

(111) No. 67626

(180) 19/06/2035

(540) Registration

The logo for FLYAI, featuring the word "FLYAI" in a bold, italicized, sans-serif font. The letters are black with a slight shadow effect, giving it a three-dimensional appearance.

(511) 09

(210) No. 52490

(220) 19/06/2025

(732) ALIBABA INNOVATION PRIVATE
LIMITED

51 Bras Basah Road, #03-06 Lazada One,
Singapore 189554, Singapore

(111) No. 67627

(180) 19/06/2035

(540) Registration



(511) 43

(210) No. 52489

(220) 19/06/2025

(732) Anhui Huiwang Catering Management Co., Ltd.

No. 8, Floor 23, Building 2, Guanyi Building,
Bengbu City, Anhui Province, China

(111) No. 67628

(180) 19/06/2035

(540) Registration



(511) 35

(210) No. 52488

(220) 19/06/2025

(732) Anhui Huiwang Catering Management Co., Ltd.

No. 8, Floor 23, Building 2, Guanyi Building,
Bengbu City, Anhui Province, China

(111) No. 67629

(180) 19/06/2035

(540) Registration



(511) 32

(210) No. 52487

(220) 19/06/2025

(732) Anhui Huiwang Catering Management Co., Ltd.

No. 8, Floor 23, Building 2, Guanyi Building,
Bengbu City, Anhui Province, China

(111) No. 67630

(180) 19/06/2035

(540) Registration



(511) 30

(210) No. 52486

(220) 19/06/2025

(732) Anhui Huiwang Catering Management Co., Ltd.

No. 8, Floor 23, Building 2, Guanyi Building,
Bengbu City, Anhui Province, China

(111) No. 67631

(180) 19/06/2035

(540) Registration



(511) 29

(210) No. 52485

(220) 19/06/2025

(732) Anhui Huiwang Catering Management Co., Ltd.

No. 8, Floor 23, Building 2, Guanyi Building,
Bengbu City, Anhui Province, China

(111) No. 67632

(180) 19/06/2035

(540) Registration



(511) 29

(210) No. 52483

(220) 19/06/2025

(732) ບໍລິສັດ ນໍ້າຕ້າງຄໍາ ຫຼວງພະບາງ ການຄ້າ ຂາເຂົ້າ-
ຂາອອກ ຈໍາກັດ

ບ້ານ ຊຽງລ້ອມ, ນະຄອນຫຼວງພະບາງ, ແຂວງ
ຫຼວງພະບາງ, ສປປ ລາວ

(111) No. 67633

(180) 19/06/2035

(540) Registration



(511) 29

(210) No. 52479

(220) 18/06/2025

(732) CHABAA BANGKOK CO., LTD.
NO. 470 VILLAGE NO. 1, SUKHUMVIT
ROAD, BANGPOOMAI SUB-DISTRICT,
MUEANG SAMUT PRAKAN DISTRICT,
SAMUT PRAKAN PROVINCE,
THAILAND

(111) No. 67634

(180) 18/06/2035

(540) Registration

HAOMAN

(511) 12

(210) No. 52526

(220) 24/06/2025

(732) ບໍລິສັດ ຫາວເຈ ລາວ ຈຳກັດຜູ້ດຽວ

ບ້ານ ໂພນສະຫວັນ, ເມືອງ ທ່າພະບາດ, ແຂວງ

ບໍລິຄຳໄຊ, ສປປ ລາວ

(111) No. 67635

(180) 24/06/2035

(540) Registration

KEYOTA

(511) 12

(210) No. 52523

(220) 24/06/2025

(732) ບໍລິສັດ ຫາວເຈ ລາວ ຈຳກັດຜູ້ດຽວ

ບ້ານ ໂພນສະຫວັນ, ເມືອງ ທ່າພະບາດ, ແຂວງ

ບໍລິຄຳໄຊ, ສປປ ລາວ

(111) No. 67636

(180) 24/06/2035

(540) Registration

NAMOTA

(511) 12

(210) No. 52524

(220) 24/06/2025

(732) ບໍລິສັດ ຫາວເຈ ລາວ ຈຳກັດຜູ້ດຽວ

ບ້ານ ໂພນສະຫວັນ, ເມືອງ ທ່າພະບາດ, ແຂວງ

ບໍລິຄຳໄຊ, ສປປ ລາວ

(111) No. 67637

(180) 24/06/2035

(540) Registration

HAOWO

(511) 12

(210) No. 52525

(220) 24/06/2025

(732) ບໍລິສັດ ຫາວເຈ ລາວ ຈຳກັດຜູ້ດຽວ

ບ້ານ ໂພນສະຫວັນ, ເມືອງ ທ່າພະບາດ, ແຂວງ

ບໍລິຄຳໄຊ, ສປປ ລາວ

(111) No. 67638

(180) 24/06/2035

(540) Registration

The logo for FLYAI, featuring the word "FLYAI" in a bold, italicized, sans-serif font. The letters are black with a slight shadow effect, giving it a three-dimensional appearance.

(511) 43

(210) No. 52496

(220) 19/06/2025

(732) ALIBABA INNOVATION PRIVATE
LIMITED

51 Bras Basah Road, #03-06 Lazada One,
Singapore 189554, Singapore

(111) No. 67639

(180) 19/06/2035

(540) Registration

The logo for FLYAI, featuring the word "FLYAI" in a bold, italicized, sans-serif font. The letters are black with a slight shadow effect, giving it a three-dimensional appearance.

(511) 42

(210) No. 52495

(220) 19/06/2025

(732) ALIBABA INNOVATION PRIVATE
LIMITED

51 Bras Basah Road, #03-06 Lazada One,
Singapore 189554

(111) No. 67640

(180) 19/06/2035

(540) Registration

The logo for FLYAI, featuring the word "FLYAI" in a bold, italicized, sans-serif font. The letters are black with a white outline, and the "Y" and "A" are connected.

(511) 41

(210) No. 52494

(220) 19/06/2025

(732) ALIBABA INNOVATION PRIVATE
LIMITED

51 Bras Basah Road, #03-06 Lazada One,
Singapore 189554

(111) No. 67641

(180) 19/06/2035

(540) Registration

The logo for FLYAI, featuring the word "FLYAI" in a bold, italicized, sans-serif font. The letters are black with a white outline, and the "Y" and "A" are connected.

(511) 39

(210) No. 52493

(220) 19/06/2025

(732) ALIBABA INNOVATION PRIVATE
LIMITED

51 Bras Basah Road, #03-06 Lazada One,
Singapore 189554

(111) No. 67642

(180) 19/06/2035

(540) Registration

The logo for FLYAI, featuring the word "FLYAI" in a bold, italicized, sans-serif font. The letters are black with a slight shadow effect, giving it a three-dimensional appearance.

(511) 38

(210) No. 52492

(220) 19/06/2025

(732) ALIBABA INNOVATION PRIVATE
LIMITED

51 Bras Basah Road, #03-06 Lazada One,
Singapore 189554

(111) No. 67643

(180) 19/06/2035

(540) Registration

The logo for OPERA, featuring the word "OPERA" in a bold, serif font. The letters are black and have a classic, elegant appearance.

(511) 03

(210) No. 52531

(220) 25/06/2025

(732) PIAS CORP.

No. 19-3, Toyosaki 3-chome, Kita-ku, Osaka, Japan

(111) No. 67644

(180) 25/06/2035

(540) Registration

MAIÆE CHANGES

(511) 20

(210) No. 52529

(220) 24/06/2025

(732) GUANRON HOLDINGS LIMITED

Unit A 8/F Chinaweal Ctr, 414-424 Jaffe Rd
Causeway Bay, Hong Kong

(111) No. 67645

(180) 24/06/2035

(540) Registration

goodhealth
NATURALLY NEW ZEALAND

(511) 05

(210) No. 52528

(220) 24/06/2025

(732) Good Health Products Limited

265 Albany Highway, Albany, Auckland,
New Zealand

(111) No. 67646

(180) 24/06/2035

(540) Registration

PMC

(511) 09

(210) No. 52544

(220) 26/06/2025

(732) ຮ້ານ ຟີເອັມ ໂອໂຕ ເກດ ເຊີວິດ ສ່ວນບຸກຄົນ

ບ້ານ ດົງຄຳຊ້າງ, ເມືອງ ຫາດຊາຍຝອງ,

ນະຄອນຫຼວງວຽງຈັນ, ສປປ ລາວ

(111) No. 67647

(180) 26/06/2035

(540) Registration

©21

(511) 35 and 36

(210) No. 52542

(220) 25/06/2025

(732) Century 21 Real Estate LLC

175 Park Avenue, Madison, New Jersey

07940, United States of America

(111) No. 67648

(180) 25/06/2035

(540) Registration



(511) 35

(210) No. 52540

(220) 25/06/2025

(732) Century 21 Real Estate LLC

175 Park Avenue, Madison, New Jersey
07940, United States of America

(111) No. 67649

(180) 25/06/2035

(540) Registration



(511) 36

(210) No. 52536

(220) 25/06/2025

(732) Century 21 Real Estate LLC

175 Park Avenue, Madison, New Jersey
07940, United States of America

(111) No. 67650

(180) 25/06/2035

(540) Registration



(511) 03, 04, 07, 09, 11, 16, 24 and 30

(210) No. 52527

(220) 24/06/2025

(732) ຮ້ານ ອາຜິງ ຈຳກັດ

ບ້ານ ໂພນສະຫວັນ, ນະຄອນປາກເຊ,

ແຂວງ ຈຳປາສັກ, ສປປ ລາວ

(111) No. 67651

(180) 24/06/2035

(540) Registration



(511) 21

(210) No. 52543

(220) 25/06/2025

(732) Zhejiang Kuangdi Industry and Trade Co., Ltd

No. 8 Jinfu Road, Guanshanbei Industrial

Zone, Tangxian Town, Yongkang City,

Jinhua City, Zhejiang Province, China

(111) No. 67652

(180) 25/06/2035

(540) Registration

The logo for ICAR, featuring the letters 'ICAR' in a bold, black, sans-serif font. The 'I' and 'C' are connected, and the 'A' and 'R' are also connected.

(511) 37

(210) No. 52546

(220) 26/06/2025

(732) Chery New Energy Automobile Co., LTD
No.226 Huajin South Road, High-Tech
Development Zone, Wuhu, Anhui Province,
China

(111) No. 67653

(180) 26/06/2035

(540) Registration

The logo for PM Auto Gate Service. It consists of a blue square containing the white letters 'PM'. To the right of this square is a red rectangle containing the white text 'Auto Gate' in a bold, sans-serif font. Below the red rectangle is a white rectangle containing the black text 'Service' in a bold, sans-serif font.

(511) 35 and 37

(210) No. 52545

(220) 26/06/2025

(732) ຮ້ານ ຟີເອັມ ໂອໂຕ ເກດ ເຊີວິດ ສ່ວນບຸກຄົນ
ບ້ານ ດົງຄຳຊ້າງ, ເມືອງ ຫາດຊາຍຝອງ,
ນະຄອນຫຼວງວຽງຈັນ, ສປປ ລາວ

(111) No. 67654

(180) 26/06/2035

(540) Registration



(511) 41

(210) No. 52522

(220) 24/06/2025

(732) ບໍລິສັດ ສະຖາບັນພາສາຈີນ ແລະ ວັດທະນະທຳ

ນະຄອນຫຼວງວຽງຈັນ ຈຳກັດຜູ້ດຽວ

ບ້ານ ຊ້າງຄູ້, ເມືອງ ໄຊທານີ, ນະຄອນຫຼວງວຽງຈັນ,

ສປປ ລາວ

(111) No. 67655

(180) 24/06/2035

ພາກທີ III
(Part III)
ເຄື່ອງໝາຍການຄ້າ
Trademarks

3. ການຕໍ່ອາຍຸ
(Renewal)

ຄຳອະທິບາຍກ່ຽວກັບລະຫັດຫຍໍ້
(Introduction of Codes)

- (540) ເຄື່ອງໝາຍການຄ້າ (Trademark)
- (511) ໝວດ (Nice Classification)
- (210) ເລກທີ ຄຳຮ້ອງ (Number of the application)
- (220) ວັນທີ ຄຳຮ້ອງ (Date of filing of the application)
- (732) ຊື່ ແລະ ທີ່ຢູ່ ຂອງຜູ້ຍື່ນຄຳຮ້ອງ (Name and Address of applicant)
- (111) ເລກທີການຈັດທະບຽນເຄື່ອງໝາຍການຄ້າ (Number of the registration)
- (180) ການຕໍ່ອາຍຸການຈັດທະບຽນ (Expiration date of the renewal)

ພາກທີ III
(Part III)

ເຄື່ອງໝາຍການຄ້າ
Trademarks

4. ການປ່ຽນແປງ
(Changes)

ພາກທີ III
(Part III)
ເຄື່ອງໝາຍການຄ້າ
Trademarks

5. ການດັດແກ້
(Amendments)

ພາກທີ IV

(Part IV)

ເຄື່ອງໝາຍການຄ້າຜ່ານລະບົບມາດຣິດ

Trademarks via Madrid Protocol

1. ຄໍາຮ້ອງ

(Applications)

ຄໍາອະທິບາຍກ່ຽວກັບລະຫັດຫຍໍ້

(Introduction of Codes)

- (540) ເຄື່ອງໝາຍການຄ້າ (Trademark)
- (511) ໝວດ (Nice Classification)
- (210) ເລກທີ ຄໍາຮ້ອງ (Number of the application)
- (220) ວັນທີ ຄໍາຮ້ອງ (Date of filing of the application)
- (732) ຊື່ ແລະ ທີ່ຢູ່ ຂອງຜູ້ຍື່ນຄໍາຮ້ອງ (Name and Address of applicant)

ພາກທີ IV
(Part IV)

ເຄື່ອງໝາຍການຄ້າຜ່ານລະບົບມາດຣິດ
Trademarks via Madrid Protocol

2. ຜົນການຈົດທະບຽນ
(Registration)

ຄຳອະທິບາຍກ່ຽວກັບລະຫັດຫຍໍ້
(Introduction of Codes)

- (540) ເຄື່ອງໝາຍການຄ້າ (Trademark)
- (511) ໝວດ (Nice Classification)
- (210) ເລກທີ ຄຳຮ້ອງ (Number of the application)
- (220) ວັນທີ ຍື່ນຄຳຮ້ອງ (Date of filing of the application)
- (732) ຊື່ ແລະ ທີ່ຢູ່ ຂອງຜູ້ຍື່ນຄຳຮ້ອງ (Name and Address of applicant)
- (111) ເລກທີການຈົດທະບຽນເຄື່ອງໝາຍການຄ້າ (Number of the registration)
- (180) ວັນໝົດອາຍຸຂອງການຈົດທະບຽນ (Expiration date of the registration)

(540) Madrid Registration

HADRON

(511) 12, 25 and 42

(210) No. M/1260579

(220) 22/05/2025

(732) Swiss Side Technologies AG

Bönirainstraße 14 CH-8800 Thalwil,
Switzerland

(111) No. M/1260579

(180) 21/05/2035

(540) Madrid Registration

MIKKELLER

(511) 25, 32, 33, 41 and 43

(210) No. M/1275568

(220) 06/05/2025

(732) Bjergsø Holding ApS

Humletorvet 27, 3. sal. DK-1799 København
V, Denmark

(111) No. M/1275568

(180) 26/10/2035

(540) Madrid Registration

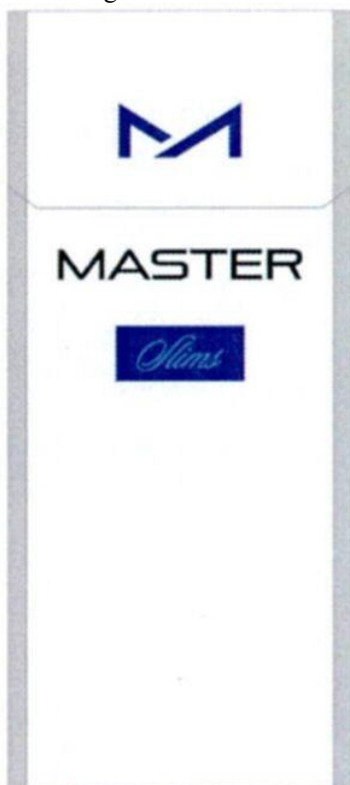

(511) 34

(210) No. M/1398791

(220) 07/05/2025

(732) "INTERNATIONAL MASIS TABAK" LLC

10 Hrant Vardanyan str.

Masis 0802 Ararat region, Armenia

(111) No. M/1398791

(180) 16/11/2027

(540) Madrid Registration



(511) 30

(210) No. M/1457366

(220) 09/06/2025

(732) Chuew Huad Maeng Co.,Ltd

500 Bangsean-Angsila Road, Saensuk

Sub-District, 20130 Muang District,

Chonburi, Thailand

(111) No. M/1457366

(180) 30/11/2028

(540) Madrid Registration



(511) 30

(210) No. M/1457751

(220) 09/06/2025

(732) Chuew Huad Mange Company Limited
500 Bangsean-Angsila Road,
Saensuk Sub-district 20130 Muang District,
Chonburi, Thailand

(111) No. M/1457751

(180) 30/11/2028

(540) Madrid Registration



(511) 30

(210) No. M/1459955

(220) 09/06/2025

(732) CHUEW HUAD MANGE CO., LTD
500 Bangsean-Angsila Road, Saensuk
Sub-District 20130 Muang District,
Chonburi, Thailand

(111) No. M/1459955

(180) 30/11/2028

(540) Madrid Registration

IQIRVO

(511) 05

(210) No. M/1472986

(220) 19/05/2025

(732) GENFIT

885 avenue Eugène Avinée,

Parc Eurasanté F-59120 LOOS, France

(111) No. M/1472986

(180) 08/04/2029

(540) Madrid Registration



(511) 35

(210) No. M/1549455

(220) 26/05/2025

(732) BGF Retail Co., Ltd.

Teheran-ro 405 (Samsung-dong),

Gangnam-gu Seoul, Republic of Korea

(111) No. M/1549455

(180) 13/12/2029

(540) Madrid Registration

EXDENSUR

(511) 05

(210) No. M/1628399

(220) 21/05/2025

(732) Glaxo Group Limited

GSK Medicines Research Centre Gunnels

Wood Road, Stevenage SG1 2NY,

United Kingdom

(111) No. M/1628399

(180) 07/10/2031

(540) Madrid Registration

抹竹

(511) 01, 02, 30 and 32

(210) No. M/1628576

(220) 07/05/2025

(732) Senlong Bio-Tech Co.,Ltd.

No. 320, Group 2, Caoping Village, Siyan

Town, Lushan County, Ya'an City Sichuan

Province, China

(111) No. M/1628576

(180) 10/09/2031

(540) Madrid Registration

MATZHU

(511) 01, 02, 30 and 32

(210) No. M/1629901

(220) 07/05/2025

(732) Senlong Bio-Tech Co.,Ltd.

No. 320, Group 2, Caoping Village, Siyan
Town, Lushan County, Ya'an City Sichuan
Province, China

(111) No. M/1629901

(180) 10/09/2031

(540) Madrid Registration

XG

(511) 09, 35 and 41

(210) No. M/1635814

(220) 16/05/2025

(732) Avex Inc.

1-4-1 Mita, Minato-ku Tokyo 108-0073,
Japan

(111) No. M/1635814

(180) 30/09/2031

(540) Madrid Registration

**SOS CHILDREN'S
VILLAGES**

(511) 36, 41, 43 and 44

(210) No. M/1635903

(220) 04/06/2025

(732) SOS-Kinderdorf

Stafflerstraße 10a A-6020 Innsbruck, Austria

(111) No. M/1635903

(180) 12/07/2031

(540) Madrid Registration

TENZERO

(511) 03 and 35

(210) No. M/1680789

(220) 13/05/2025

(732) An Kyung Yeol

110-dong 2403-ho, 275, Banpo- daero,

Seocho-gu Seoul, Republic of Korea

(111) No. M/1680789

(180) 04/08/2032

(540) Madrid Registration

LOFREMVI

(511) 05

(210) No. M/1698863

(220) 15/05/2025

(732) Novartis AG

CH-4002 Basel, Switzerland

(111) No. M/1698863

(180) 30/09/2032

(540) Madrid Registration

SYX

(511) 34

(210) No. M/1759933

(220) 03/06/2025

(732) DanCzek Teplice a.s.

Kamenný Pahorek 116 CZ-417 23 Košťany,

Czech Republic

(111) No. M/1759933

(180) 06/09/2033

(540) Madrid Registration

BABY SHEEP

(511) 05

(210) No. M/1763081

(220) 28/05/2025

(732) Chenrui (Fujian) Industry and Trade Co., Ltd.

Derun Industrial Park, No. 401, South Binhu
Road, Zhangban Town, Quanzhou Taiwanese
Investment Zone Fujian Province, China

(111) No. M/1763081

(180) 15/08/2033

(540) Madrid Registration



(511) 29, 30, 32, 33, 35 and 43

(210) No. M/1765099

(220) 06/05/2025

(732) CYYs (HK) Brand Management Limited

UNIT 5, 13/F NEW TREND CTR NO 704
PRINCE EDWARD RD EAST KLN HONG
KONG, CHINA

(111) No. M/1765099

(180) 23/10/2033

(540) Madrid Registration

EXTER

(511) 12

(210) No. M/1777498

(220) 21/05/2025

(732) HYUNDAI MOTOR COMPANY

12, Heolleung-ro, Seocho-gu Seoul 06797,
Republic of Korea

(111) No. M/1777498

(180) 19/01/2034

(540) Madrid Registration

the mora

(511) 03, 16, 18, 24, 25, 28, 39, 41, 43 and 44

(210) No. M/1787808

(220) 20/05/2025

(732) TUI AG

Karl-Wiechert-Allee 23 30625 Hannover,
Germany

(111) No. M/1787808

(180) 06/12/2033

(540) Madrid Registration

the mora

(511) 03, 16, 18, 24, 25, 28, 39, 41, 43 and 44

(210) No. M/1788737

(220) 20/05/2025

(732) TUI AG

Karl-Wiechert-Allee 23 30625 Hannover,
Germany

(111) No. M/1788737

(180) 18/12/2033

(540) Madrid Registration

COATS ECOVERDE

(511) 23

(210) No. M/1797301

(220) 30/05/2025

(732) J. & P. Coats, Limited

1 George Square Glasgow, Scotland G2 1AL,
United Kingdom

(111) No. M/1797301

(180) 29/04/2034

(540) Madrid Registration



(511) 35 and 39

(210) No. M/1828017

(220) 27/05/2025

(732) L.V. Vlaardingen Holding B.V.

Koggehaven 24 NL-3133 LA Vlaardingen,

The Netherlands

(111) No. M/1828017

(180) 01/10/2034

(540) Madrid Registration

The logo is the word 'Brud' written in a bold, black, sans-serif font. The letters are closely spaced and have a slightly irregular, hand-drawn appearance.

(511) 09

(210) No. M/1832918

(220) 28/05/2025

(732) Taizhou Baoluda Electric Technology Co.,Ltd

Yongan Industrial Agglomeration Zone,

Xianju County 317300 Zhejiang Province,

China

(111) No. M/1832918

(180) 12/10/2034

(540) Madrid Registration

Airbaby

(511) 03, 05 and 16

(210) No. M/1842241

(220) 13/05/2025

(732) BETA GIDA SANAYİ VE TİCARET

ANONİM ŞİRKETİ

ACIDEREOSB MAH. FUZULİ CAD. 1

SARIÇAM ADANA, TURKEY

(111) No. M/1842241

(180) 06/01/2035

(540) Madrid Registration

**RAINFOREST
TRUST**

(511) 35 and 36

(210) No. M/1857556

(220) 15/04/2025

(732) Rainforest Trust

7200 Lineweaver Road Warrenton VA 20187,

United States of America

(111) No. M/1857556

(180) 15/04/2035

(540) Madrid Registration



(511) 21

(210) No. M/1857593

(220) 15/04/2025

(732) Quanzhou Xiechuang Horticulture Co., Ltd.

No. 68, Muding, Xiaxi Village, Heshi Town,

Luojiang District, Quanzhou City 362013

Fujian Province, China

(111) No. M/1857593

(180) 15/04/2035

(540) Madrid Registration

AUDLEY

(511) 07

(210) No. M/1857595

(220) 15/04/2025

(732) Henan Yindu Digital Co., Ltd

Intersection of Kunlun Mountain Road and

Yongdinghe Road in Pingyuan

Demonstration Zone, Yuanyang County,

Xinxiang City 453500 Henan Province

(Zhongyuan Printing and Packaging

Industry Park), China

(111) No. M/1857595

(180) 15/04/2035

(540) Madrid Registration

The logo for DAVIS, featuring the word "DAVIS" in a bold, serif font, followed by a stylized, flowing script element that resembles a lowercase "s" or a decorative flourish.

(511) 03

(210) No. M/1857707

(220) 15/04/2025

(732) Zhejiang Davis Industrial Co., Ltd.

No.10, Xinguang North Road, Qingkou

Industrial Zone, Jiangdong Street, Yiwu City

Zhejiang Province, China

(111) No. M/1857707

(180) 15/04/2035

(540) Madrid Registration



(511) 10

(210) No. M/1857710

(220) 15/04/2025

(732) Guangzhou Shijing Medical Software Co.,

Ltd.

Room 801-808, 8th Floor, South Building,

24-26 Keyun Road, Tianhe District,

Guangzhou Guangdong, China

(111) No. M/1857710

(180) 15/04/2035

(540) Madrid Registration



Hopers

(511) 05

(210) No. M/1857919

(220) 17/04/2025

(732) Fujian Nanan Quanfa Paper Products Co.,
Ltd.

Lujiang Industrial Zone, Liucheng Office,
Nanan City 362300 Fujian Province, China

(111) No. M/1857919

(180) 17/04/2035

(540) Madrid Registration

BABYOLOGY

(511) 05

(210) No. M/1857923

(220) 18/04/2025

(732) Quanzhou Lequ Infant Products Co., Ltd.

Room 2001, Building 13, Donghai Taihe
Plaza, No. 1466, Daxing Street, Fengze
District, Quanzhou City 362018 Fujian
Province, China

(111) No. M/1857923

(180) 18/04/2035

(540) Madrid Registration



(511) 30

(210) No. M/1858571

(220) 21/04/2025

(732) Hai' an City Crop Cultivation Technology

Guidance Station

No. 20 Zhongba South Road, Hai'an City,

Nantong City 226600 Jiangsu Province,

China

(111) No. M/1858571

(180) 21/04/2035

(540) Madrid Registration



(511) 29

(210) No. M/1858637

(220) 18/04/2025

(732) Shanghai Yosun Dairy Technology Co., Ltd

B7, 1st Floor, Building 12, No. 319 Caolian

Road, Minhang District 201108 Shanghai,

China

(111) No. M/1858637

(180) 18/04/2035

(540) Madrid Registration



宇嘉
YU JIA

(511) 12

(210) No. M/1859812

(220) 11/04/2025

(732) Qinrong Qu

No.2 Liangjia Village, Xinhe Town, Wenling
City 317502 Zhejiang Province, China

(111) No. M/1859812

(180) 11/04/2035

(540) Madrid Registration



(511) 30, 35 and 43

(210) No. M/1860335

(220) 15/04/2025

(732) GODIVA BELGIUM B.V./S.R.L.

Veeartsenstraat 42 D B-1070 Anderlecht,
Belgium

(111) No. M/1860335

(180) 15/04/2035

(540) Madrid Registration

Xmoment

(511) 10

(210) No. M/1860762

(220) 15/04/2025

(732) Shenzhen Yidui'ai Technology Co., Ltd.

Room 205, 2nd Floor, Building 1, Haizhicheng

E-commerce Park, No. 18, Lane 5, Changkeng

District, Yangmei Community, Bantian Street,

Longgang District, Shenzhen 518000

Guangdong, China

(111) No. M/1860762

(180) 15/04/2035

(540) Madrid Registration

LEPAS

(511) 37

(210) No. M/1861712

(220) 22/04/2025

(732) Chery Automobile Co., Ltd.

No.8 Changchun Road, Economy &

Technology Development Zone, Wuhu City

241009 Anhui Province, China

(111) No. M/1861712

(180) 22/04/2035

(540) Madrid Registration

The logo consists of the word "LASPA" in a bold, italicized, sans-serif font. The letters are black and have a slight shadow effect.

(511) 07

(210) No. M/1790751

(220) 28/03/2025

(732) WENLING OUYI ELECTRIC CO., LTD.

Injection Molding Park (in Tianyi Insulating Sleeve Factory), Daxi Town, Wenling City, Taizhou City 317500 Zhejiang Province, China

(111) No. M/1790751

(180) 14/03/2034

(540) Madrid Registration

The logo consists of the Chinese characters "潮宏基" (Chāohóngjī) in a bold, black, sans-serif font.

(511) 14

(210) No. M/1805858

(220) 28/03/2025

(732) GUANGDONG CHJ INDUSTRY

(HOLDINGS) CO., LTD.

Floor 12, Office Tower, Chaohongji Plaza, NO.98, Nanbin Road, Haojiang District, Shantou City Guangdong Province, China

(111) No. M/1805858

(180) 13/06/2034

(540) Madrid Registration

CHJ JEWELLERY

(511) 14

(210) No. M/1806807

(220) 28/03/2025

(732) GUANGDONG CHJ INDUSTRY

(HOLDINGS) CO., LTD.

Floor 12, Office Tower, Chaohongji Plaza,

NO.98, Nanbin Road, Haojiang District,

Shantou City Guangdong Province, China

(111) No. M/1806807

(180) 13/06/2034

(540) Madrid Registration

Fulan Sweet

(511) 30

(210) No. M/1857604

(220) 14/03/2025

(732) Suzhou Fulan Sweet Food Co.,Ltd

Building 55, No.12 Jifu Road, Fenghuang

Town, Zhangjiagang City, Suzhou City

215000 Jiangsu Province, China

(111) No. M/1857604

(180) 14/03/2035

(540) Madrid Registration

DEAR SEED

(511) 03

(210) No. M/1857606

(220) 14/03/2025

(732) Guangzhou Biqian DAILY-USED Cosmetics
Co, Ltd.

No. 68 Caozhuang Middle Road, Taihe
Town, Baiyun District, Guangzhou City
510000 Guangdong Province, China

(111) No. M/1857606

(180) 14/03/2035

(540) Madrid Registration

塔斯汀

(511) 30, 35 and 43

(210) No. M/1857697

(220) 05/03/2025

(732) Fuzhou Tasiting Catering Management Co.,
Ltd.

Room 2301, 23rd Floor, Building 2, Huajian
Building, No. 12, 16, and 18 Keji East Road,
Fuzhou High Tech Zone 350108 Fujian
Province, China

(111) No. M/1857697

(180) 05/03/2035

(540) Madrid Registration



(511) 30, 35 and 43

(210) No. M/1857709

(220) 05/03/2025

(732) Fuzhou Tasting Catering Management Co.,
Ltd.

Room 2301, 23rd Floor, Building 2, Huajian
Building, No. 12, 16, and 18 Keji East Road,
Fuzhou High Tech Zone 350108 Fujian
Province, China

(111) No. M/1857709

(180) 05/03/2035

(540) Madrid Registration

毛穴撫子

(511) 03

(210) No. M/1857715

(220) 09/04/2025

(732) Ishizawa Laboratories Inc.

4-4-9 Jingumae, Shibuya-ku Tokyo
150-0001, Japan

(111) No. M/1857715

(180) 09/04/2035

(540) Madrid Registration



(511) 03

(210) No. M/1857716

(220) 09/04/2025

(732) Ishizawa Laboratories Inc.

4-4-9 Jingumae, Shibuya-ku Tokyo

150-0001, Japan

(111) No. M/1857716

(180) 09/04/2035

(540) Madrid Registration



(511) 07

(210) No. M/1857924

(220) 11/03/2025

(732) Zhejiang Farmertec Power Technology

Co.,Ltd

No.11, Lulin North Road, Qujiang District,

Quzhou City 324000 Zhejiang Province,

China

(111) No. M/1857924

(180) 11/03/2035

(540) Madrid Registration

LOGOS DE LA MARQUE BINGGYS

BINGGYS



(511) 03, 05 and 44

(210) No. M/1857959

(220) 28/03/2025

(732) G2G holding

108ter Avenue du Maréchal Foch F-78100

Saint-Germain-en-Laye, France

(111) No. M/1857959

(180) 27/03/2026

(540) Madrid Registration

LIFLOR

(511) 19

(210) No. M/1858005

(220) 06/03/2025

(732) Inner Mongolia Luju Plastic Products
Co., Ltd.

West of Jingzhang 4th Road, North of

Jingzhang 2nd Road, Chahar Right Wing

Front Banner, Ulanqab City Inner Mongolia

Autonomous Region, China

(111) No. M/1858005

(180) 06/03/2035

(540) Madrid Registration

The logo for YUSK, featuring the word "YUSK" in a bold, italicized, sans-serif font.

(511) 09

(210) No. M/1858007

(220) 05/03/2025

(732) Foshan YOPROM Technology Co., Ltd

4th Floor, Dongcheng Commercial Building,

Yanbu Hedong Central Road, Dali Town,

Nanhai District, Foshan City 528299

Guangdong Province, China

(111) No. M/1858007

(180) 05/03/2035

(540) Madrid Registration

The logo for DAYHOK, featuring the word "DAYHOK" in a bold, sans-serif font. The letter "O" is replaced by a stylized black circle with a white dot inside, resembling a drop or a stylized letter.

(511) 03

(210) No. M/1858575

(220) 24/03/2025

(732) GUANGZHOU UNIASIA COSMETIC

TECHNOLOGY CO., LTD.

No.15 Kelin Road, Guangzhou Science City,

Guangzhou City Guangdong Province, China

(111) No. M/1858575

(180) 24/03/2035

(540) Madrid Registration



(511) 29

(210) No. M/1858611

(220) 10/03/2025

(732) Fujian Yuguan Investment Co., Ltd.

No.1 Fangcheng Road, Yuanhong

International Food Industry Park, Fuqing

Functional Zone, Fuzhou New District,

Chengtou Town, Fuqing City, Fuzhou City

350300 Fujian Province, China

(111) No. M/1858611

(180) 10/03/2035

(540) Madrid Registration

YOPROM

(511) 09

(210) No. M/1858613

(220) 05/03/2025

(732) Foshan YOPROM Technology Co., Ltd

4th Floor, Dongcheng Commercial Building,

Yanbu Hedong Central Road, Dali Town,

Nanhai District, Foshan City 528299

Guangdong Province, China

(111) No. M/1858613

(180) 05/03/2035

(540) Madrid Registration



(511) 09

(210) No. M/1858625

(220) 13/03/2025

(732) TECMEN ELECTRONICS CO., LTD

No. 8, Huyue East Road, Longchi Street,
Liuhe District, Nanjing 210000 Jiangsu,
China

(111) No. M/1858625

(180) 13/03/2035

(540) Madrid Registration

The logo consists of the Chinese characters '中焙' (Zhongbei) in a large, bold, black, sans-serif font. The characters are centered within a light gray rectangular background.

(511) 29 and 30

(210) No. M/1858630

(220) 10/03/2025

(732) Zhongbei Logistics (Wuhan) Co., Ltd

No. 123 Tian'ehu Avenue, Daji Street,
Caidian District, Wuhan City 430100 Hubei
Province, China

(111) No. M/1858630

(180) 10/03/2035

(540) Madrid Registration

Sson Tvte

(511) 09

(210) No. M/1858633

(220) 06/03/2025

(732) Chongqing Suotu Optical Glasses Co., LTD

Building 2, [China (Chongqing) Eyewear
Industrial Park - Eyewear Capital], East
section of Chengyu Highway, Rongchang
Industrial Park 402460 Chongqing, China

(111) No. M/1858633

(180) 06/03/2035

(540) Madrid Registration



(511) 07

(210) No. M/1858925

(220) 11/03/2025

(732) Zhejiang Farmertec Power Technology

Co.,Ltd

No.11, Lulin North Road, Qujiang District,
Quzhou City 324000 Zhejiang Province,
China

(111) No. M/1858925

(180) 11/03/2035

(540) Madrid Registration



(511) 06, 07, 08, 09, 11, 12, 16, 21, 22 and 25

(210) No. M/1858937

(220) 13/03/2025

(732) Ride Aventon Inc.

3040 Saturn St., Ste. 202 Brea CA 92821,

United States of America

(111) No. M/1858937

(180) 13/03/2035

(540) Madrid Registration



(511) 28

(210) No. M/1858947

(220) 18/03/2025

(732) LZ STATIONERY CO., LTD.

668 Yongzai Avenue, Xianhua Street, Pujiang

County, Jinhua City 322299 Zhejiang

Province, China

(111) No. M/1858947

(180) 18/03/2035

(540) Madrid Registration

一华正塑业

(511) 22

(210) No. M/1858963

(220) 18/03/2025

(732) Hebei Huazheng Plastic Packaging Co., Ltd

North side of Yangping Road West Section,

Daming County Hebei Province, China

(111) No. M/1858963

(180) 18/03/2035

(540) Madrid Registration

NIXO

(511) 07, 21 and 31

(210) No. M/1858977

(220) 17/03/2025

(732) Guangzhou Juliu Aquarium Technology Co.,
Ltd.

Room 1801, Lift 1, Building 3, Street 2, No.

123, Lan Cui Street, Ling Xing Road, Da

Gang Town, Nansha District, Guangzhou

Guangdong Province, China

(111) No. M/1858977

(180) 17/03/2035

(540) Madrid Registration

Found In Ation

(511) 03 and 21

(210) No. M/1859387

(220) 28/03/2025

(732) Hangzhou Meixi Aesthetics Bio-technology
Co., LTD

Rm 1512, 15th Floor, Bldg 8, no.19, Jugong
Road, Xixing St, Binjiang Dist., Hangzhou
City Zhejiang, China

(111) No. M/1859387

(180) 28/03/2035

(540) Madrid Registration

KIDDIEZOOM

(511) 25

(210) No. M/1859707

(220) 10/04/2025

(732) Quanzhou Xiami E-commerce Co., Ltd.

No. 305, Azure Coast, Yunlu Road, Fengze
District, Quanzhou City 362018 Fujian
Province, China

(111) No. M/1859707

(180) 10/04/2035

(540) Madrid Registration

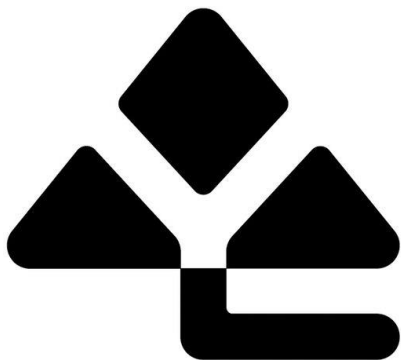

(511) 12 and 35

(210) No. M/1859781

(220) 24/03/2025

(732) Zhejiang Luyuan Electric Vehicle Co., Ltd

No.168, Shicheng Street, Jinhua City 321000

Zhejiang Province, China

(111) No. M/1859781

(180) 24/03/2035

(540) Madrid Registration

大窑
橙诺
DAYAO

(511) 32

(210) No. M/1859783

(220) 17/03/2025

(732) Dayao Jiabin Beverage Co., Ltd.

Room 208, No. 41, Xiangyang Street, High-

Tech Industrial Park, Dawukou District,

Shizuishan City 753000 Ningxia Hui

Autonomous Region, China

(111) No. M/1859783

(180) 17/03/2035

(540) Madrid Registration

The logo for HOUNY features the word "HOUNY" in a bold, black, sans-serif font. The letter "H" is stylized with a vertical bar on its left side that extends slightly above and below the main body of the letter.

(511) 09

(210) No. M/1859904

(220) 11/03/2025

(732) Shenzhen Houny Battery Co., Limited
2/F No.279, Pingkui Road, Shijing
Community, Shijing Sub-district Office,
Pingshan District, Shenzhen 518000
Guangdong, China

(111) No. M/1859904

(180) 11/03/2035

(540) Madrid Registration

The logo for Dayao consists of two vertical columns of large, bold Chinese characters. The left column contains "大" (top) and "芳" (bottom). The right column contains "窑" (top) and "爱" (bottom). Below the Chinese characters, the word "DAYAO" is written in a bold, black, sans-serif font.

(511) 32

(210) No. M/1859961

(220) 14/03/2025

(732) Dayao Jiabin Beverage Co., Ltd.
Room 208, No. 41, Xiangyang Street, High-
Tech Industrial Park, Dawukou District,
Shizuishan City 753000 Ningxia Hui
Autonomous Region, China

(111) No. M/1859961

(180) 14/03/2035

(540) Madrid Registration

大窑
嘉宾
DAYAO

(511) 32

(210) No. M/1859971

(220) 17/03/2025

(732) Dayao Jiabin Beverage Co., Ltd.

Room 208, No. 41, Xiangyang Street, High-

Tech Industrial Park, Dawukou District,

Shizuishan City 753000 Ningxia Hui

Autonomous Region, China

(111) No. M/1859971

(180) 17/03/2035

(540) Madrid Registration

大窑
芳相
DAYAO

(511) 32

(210) No. M/1859972

(220) 17/03/2025

(732) Dayao Jiabin Beverage Co., Ltd.

Room 208, No. 41, Xiangyang Street,

High-Tech Industrial Park, Dawukou District,

Shizuishan City 753000 Ningxia Hui

Autonomous Region, China

(111) No. M/1859972

(180) 17/03/2035

(540) Madrid Registration

TENCHEN

(511) 12

(210) No. M/1860888

(220) 08/04/2025

(732) Zhejiang Tenchen Controls Co., Ltd.

West Industrial Zone, Tiantai County, Taizhou

City 317200 Zhejiang Province, China

(111) No. M/1860888

(180) 08/04/2035

(540) Madrid Registration

EMBEST

(511) 06 and 11

(210) No. M/1861281

(220) 28/03/2025

(732) Suzhou Dake Investment Consultation Co.,
Ltd.

Room 618, Building Number 1, Lucky City

Commercial Center, Suzhou Industrial Park,

Suzhou City Jiangsu Province, China

(111) No. M/1861281

(180) 28/03/2035

(540) Madrid Registration

The logo for SEAJIC consists of the letters 'S', 'E', 'A', 'J', 'I', and 'C' in a bold, sans-serif font. The letter 'A' is stylized with a small triangle pointing upwards from its center.

(511) 35

(210) No. M/1861307

(220) 07/03/2025

(732) Dongguan Osm Digital Co., Ltd.

Room 501, Building 2, No. 6 Tiansha Road,
Tangxia Town, Dongguan City Guangdong
Province, China

(111) No. M/1861307

(180) 07/03/2035

(540) Madrid Registration

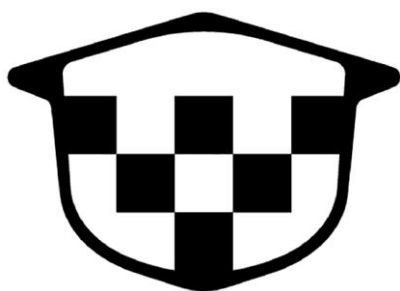

(511) 12 and 35

(210) No. M/1861423

(220) 24/03/2025

(732) Zhejiang Luyuan Electric Vehicle Co., Ltd

No.168, Shicheng Street, Jinhua City 321000
Zhejiang Province, China

(111) No. M/1861423

(180) 24/03/2035

(540) Madrid Registration

FOTON GALAXUS

(511) 12 and 35

(210) No. M/1861483

(220) 20/03/2025

(732) BEIQI FOTON MOTOR CO., LTD.

Laoniawan Village North, Shayang Road,
Shahe Town, Changping District 102206
Beijing, China

(111) No. M/1861483

(180) 20/03/2035

(540) Madrid Registration

岩
石
霸
朝

YANBA
T E A

(511) 30 and 35

(210) No. M/1861633

(220) 26/03/2025

(732) Wuyishan Yongpeng Tea Co., Ltd.

No. 37, Sijiao Jing, Xiandian Village,
Xingtian Town, Wuyishan City 354305 Fujian
Province, China

(111) No. M/1861633

(180) 26/03/2035

(540) Madrid Registration



(511) 30 and 32

(210) No. M/1861704

(220) 07/03/2025

(732) HAPPY GRAINS HOLDINGS SDN BHD
105B, JALAN SUTERA TANJUNG 8/2,
TAMAN SUTERA UTAMA 81300 SKUDAI
JOHOR, MALAYSIA

(111) No. M/1861704

(180) 07/03/2035

(540) Madrid Registration



(511) 05

(210) No. M/1861733

(220) 01/04/2025

(732) NOVARTIS AG
CH-4002 BASEL, Switzerland

(111) No. M/1861733

(180) 01/04/2035

ພາກທີ IV
(Part IV)

ເຄື່ອງໝາຍການຄ້າຜ່ານລະບົບມາດຣິດ
Trademarks via Madrid Protocol

3. ຜົນການຕໍ່ອາຍຸ
(Renewal)

ຄຳອະທິບາຍກ່ຽວກັບລະຫັດຫຍໍ້
(Introduction of Codes)

- (540) ເຄື່ອງໝາຍການຄ້າ (Trademark)
- (511) ໝວດ (Nice Classification)
- (210) ເລກທີ ຄຳຮ້ອງ (Number of the application)
- (220) ວັນທີ ຍື່ນຄຳຮ້ອງ (Date of filing of the application)
- (732) ຊື່ ແລະ ທີ່ຢູ່ ຂອງຜູ້ຍື່ນຄຳຮ້ອງ (Name and Address of applicant)
- (111) ເລກທີການຈົດທະບຽນເຄື່ອງໝາຍການຄ້າ (Number of the registration)
- (180) ການຕໍ່ອາຍຸຂອງການຈົດທະບຽນ (Expiration date of the renewal)

ພາກທີ IV

(Part IV)

ເຄື່ອງໝາຍການຄ້າຜ່ານລະບົບມາດຣິດ

Trademarks via Madrid Protocol

4. ການປ່ຽນແປງ

(Changes)

ພາກທີ IV

(Part IV)

ເຄື່ອງໝາຍການຄ້າຜ່ານລະບົບມາດຣິດ

Trademarks via Madrid Protocol

5. ການດັດແກ້

(Amendments)

ພາກທີ V
(Part V)
ຖິ່ນກຳເນີດ
Geographical Indications

1. ຄຳຮ້ອງ
(Applications)

ພາກທີ V
(Part V)
ຖິ່ນກຳເນີດ
Geographical Indications

2. ຜົນການຈົດທະບຽນ
(Registration)

ພາກທີ V
(Part V)
ຖິ່ນກຳເນີດ
Geographical Indications

2.1 ຜົນການຈົດທະບຽນ ຜ່ານລະບົບສາກົນ
(Lisbon Registration)

ພາກທີ V
(Part V)
ຖິ່ນກຳເນີດ
Geographical Indications

2.2 ຜົນການຈົດທະບຽນ ຊື່ຖິ່ນກຳເນີດສະເພາະ ຜ່ານລະບົບສາກົນ
(Lisbon Appellation of Origin Registration)

ພາກທີ V

(Part V)

ຖິ່ນກຳເນີດ

Geographical Indications

3. ການປ່ຽນແປງ

(Changes)

ພາກທີ V
(Part V)
ຖິ່ນກຳເນີດ
Geographical Indications

4. ການດັດແກ້
(Amendments)

ພາກທີ VI

(Part VI)

ພັນພືດໃໝ່

New Plant Varieties

1. ຄໍາຮ້ອງ

(Applications)

ພາກທີ VI

(Part VI)

ພັນພືດໃໝ່

New Plant Varieties

2. ຜົນການຈັດທະບຽນ

(Registration)

ພາກທີ VI
(Part VI)

ພັນພືດໃໝ່
New Plant Varieties

3. ການປ່ຽນແປງ
(Changes)

ພາກທີ VI

(Part VI)

ພັນພືດໃໝ່

New Plant Varieties

4. ການດັດແກ້

(Amendments)

ພາກທີ VII

(Part VII)

ລິຂະສິດ ແລະ ສິດກ່ຽວຂ້ອງກັບລິຂະສິດ

Copyrights and Related Rights

1. ການແຈ້ງຂໍ້ມູນ

(Notifications)

ພາກທີ VII

(Part VII)

ລິຂະສິດ ແລະ ສິດກ່ຽວຂ້ອງກັບລິຂະສິດ

Copyrights and Related Rights

2. ການປ່ຽນແປງ

(Changes)

ພາກທີ VIII

(Part VIII)

**ການແກ້ໄຂຂໍ້ຂັດແຍ່ງທາງດ້ານບໍລິຫານກ່ຽວກັບການຈົດທະບຽນຊັບ
ສິນອຸດສາຫະກຳ ແລະ ພັນພືດໃໝ່**

**Administrative Dispute Resolutions on the Registration of
Industrial Property and New Plant Varieties**

1. ຜົນການຄັດຄ້ານຄຳຮ້ອງ

(Result of Oppositions)

ພາກທີ VIII

(Part VIII)

**ການແກ້ໄຂຂໍ້ຂັດແຍ່ງທາງດ້ານບໍລິຫານກ່ຽວກັບການຈົດທະບຽນຊັບ
ສິນອຸດສາຫະກຳ ແລະ ພັນພືດໃໝ່**

**Administrative Dispute Resolutions on the Registration of
Industrial Property and New Plant Varieties**

2. ຜົນການແຈ້ງປະຕິເສດ

(Result of Refusals)

ພາກທີ VIII

(Part VIII)

**ການແກ້ໄຂຂໍ້ຂັດແຍ່ງທາງດ້ານບໍລິຫານກ່ຽວກັບການຈົດທະບຽນຊັບ
ສິນອຸດສາຫະກຳ ແລະ ພັນພືດໃໝ່**

**Administrative Dispute Resolutions on the Registration of
Industrial Property and New Plant Varieties**

**3. ຜົນການຍົກເລີກ ຫຼື ລົບລ້າງ ຂອງການຈົດທະບຽນ
(Result of Cancellation or Invalidation of Registration)**